



Operating Instructions Microwave oven





To avoid the risk of accidents or damage to the appliance, it is **essential** to read these instructions before it is installed and used for the first time.

Contents

Warning and Safety instructions	5
Before using for the first time	14
Installation	15
Building-in dimensions	15
Electrical connection	20
Caring for the environment	21
Guide to the appliance	22
Accessories supplied	23
Control panel	24
Controls	25
On/Off  sensor.....	25
Display	25
Sensor controls.....	25
Sensor controls above the display.....	25
Sensor controls under the display	26
Display symbols.....	27
Operating principles	28
Selecting a menu item or changing a value or setting	28
Selecting the operating mode or function	28
lab Cancelling cooking	28
Description of the functions	29
Modes of operation	30
Functions	30
Microwave Solo mode	30
Grilling	30
Combination mode (Microwave + Grill).....	30
Automatic programmes	30
Suitable containers for microwave use	31
Material and shape.....	31
Testing containers	33
A microwave lid or cover	34
Before using for the first time	35
Altering the time of day	35
Settings	36
Settings overview.....	36
Changing settings.....	37
Language 	37
Time.....	37
Display.....	37
Clock format	37
Set.....	37

Volume	37
Buzzer tones	38
Keypad tone	38
Display brightness	38
Units	38
Weight	38
Keeping warm	38
Quick MW	38
Popcorn	38
Oven compartment query	38
Safety	39
System lock 	39
Sensor lock	39
Software version	39
Showroom programme	39
Demo mode	39
Factory default	39
Operation	40
Opening the door	40
Placing a dish in the oven	40
Turntable	40
Closing the door	40
Starting a programme	40
Food in oven?	41
Interrupting or restarting a programme	41
Altering settings	41
Cancelling a programme	41
At the end of a programme	41
Keeping warm	42
Programming cooking durations	42
Selecting Quick microwave	42
Changing the duration and power level	42
System lock	43
Using the minute minder	44
Changing the time set for the minute minder	44
Cancelling the minute minder	44
Minute minder + cooking process	44
Operation - Grilling	45
Grilling without the Microwave function	45
Changing the grilling duration	45
Combining grill and microwave	46
To change a cooking duration	46

Contents

Gourmet plate	48
Instructions for use	48
Searing/browning food	48
Examples of use.....	49
Recipes	49
Operation - Automatic programmes	52
Automatic programmes.....	52
Cooking 	52
Defrosting.....	53
Reheating.....	53
Popcorn 	53
Recipes - Automatic programmes	54
Reheating	62
Cooking	64
Defrosting	66
Bottling	67
Examples of use	68
Cleaning and care	69
Accessories supplied.....	71
Problem solving guide	72
Service	74
Contact in case of fault.....	74
Warranty	74

Warning and Safety instructions

This appliance complies with current safety regulations. However, inappropriate use can lead to personal injury and damage to property.

Read the Operating instructions carefully before using the appliance. They contain important information on safety, installation, use and maintenance of the appliance. This prevents both personal injury and damage to the appliance.

In accordance with standard IEC 60335-1, Miele expressly and strongly advises that you read and follow the instructions in "Installation", as well as in the "Warning and Safety instructions".

Miele cannot be held liable for injury or damage caused by non-compliance with these instructions.

Keep these instructions in a safe place and pass them on to any future owner.

Correct application

- ▶ The microwave oven is intended for use in private households. This appliance is not intended for outdoor use.
- ▶ Do not use the appliance at altitudes above 2000 m.
- ▶ The microwave oven is intended for domestic use only to cook, defrost, and reheat food. Any other use is not permitted.
- ▶ If flammable items were dried in the microwave oven, the moisture in the items would evaporate. This could cause them to dry out and possibly self-ignite. Never use the microwave oven to store or dry items which could ignite easily.
- ▶ This microwave oven is not intended for use by people (including children) with reduced physical, sensory or mental capabilities or lack of experience and knowledge, unless they have been given supervision and instruction concerning its use by a person responsible for their safety. They may only use the appliance unsupervised if they have been shown how to use it in a safe way. They must be able to recognise the dangers of misuse.
- ▶ This appliance is equipped with a special lamp to cope with particular conditions (e.g. temperature, moisture, chemical resistance, abrasion resistance and vibration). This special lamp must only be used for the purpose for which it is intended. It is not suitable for room lighting. Replacement lamps may only be fitted by a Miele authorised technician or by Miele.

Warning and Safety instructions

▶ This microwave oven contains 1 light source of energy efficiency class E.

Safety with children

- ▶ Activate the system lock to ensure that children cannot switch on the microwave oven inadvertently.
- ▶ Young children must not be allowed to use the appliance.
- ▶ Older children may use the appliance without supervision if its operation has been clearly explained to them and they are able to use it safely. Children must be able to recognise and understand the potential risks of improper use.
- ▶ Children must not be allowed to clean or maintain the appliance unsupervised.
- ▶ Please supervise children in the vicinity of the microwave oven and do not let them play with it.
- ▶ Danger of suffocation! Whilst playing, children may become entangled in packaging material (such as plastic wrapping) or pull it over their head with the risk of suffocation. Keep packaging material away from children.
- ▶ Danger of burning! Children's skin is far more sensitive to high temperatures than that of adults. When grilling with or without the microwave function, the oven interior, the grill element and the door will get hot. Do not let children touch the microwave oven when it is in operation.
- ▶ Danger of injury! The oven door can support a maximum weight of 8 kg. Children could injure themselves on an open door. Do not let children sit on the door, lean against it or swing on it.

Technical safety

- ▶ A damaged appliance could be dangerous. Check the appliance for visible signs of damage. Do not use the appliance if it is damaged.
- ▶ If the electrical connection cable is damaged it must only be replaced by a Miele authorised service technician in order to prevent a hazard.

Warning and Safety instructions

- ▶ Temporary or permanent operation with a self-sufficient or non-mains synchronous energy supply system (e.g. isolated networks, back-up systems) is possible. A requirement for the operation is that the energy supply system complies with all current local and national requirements that apply to stand-alone, solar and/or battery systems. The protective measures provided in the installation and in this Miele product must also be assured in their function and operation in isolated operation or in non-mains synchronous operation, or replaced with equivalent measures in the installation.
- ▶ Operating a damaged appliance can result in microwave leakage and present a hazard to the user. Do not use the appliance if
 - the appliance door is warped.
 - the door hinges are loose.
 - holes or cracks are visible in the casing, the door or the oven interior walls.
- ▶ Any contact with live connections or tampering with the electrical or mechanical components of the microwave oven will endanger your safety and may lead to appliance malfunctions. Do not open the appliance housing under any circumstances.
- ▶ Before connecting the appliance to the power supply, ensure that the connection data on the data plate (voltage and frequency) match the mains electricity supply. This data must correspond in order to avoid the risk of damage to the appliance. If in doubt, consult a qualified electrician.
- ▶ Do not use multi-socket adapters and extension leads to connect the microwave oven to the electricity supply. They are a fire hazard and do not guarantee the required safety of the appliance.
- ▶ The electrical safety of this microwave oven can only be guaranteed when continuity is complete between it and an effective earthing system. It is essential that this standard safety requirement is met to avoid the risk of damage or electric shock due to a missing or disconnected protective conductor. If in any doubt, please have the electrical installation tested by a qualified electrician.
- ▶ For safety reasons, this appliance may only be used when it has been built in.
- ▶ Unauthorised installation, maintenance and repairs (including removal of any cover) can cause considerable danger for the user. Installation must be performed by a suitably qualified and competent person. Maintenance and repairs must only be carried out by a Miele authorised technician.

Warning and Safety instructions

- ▶ Any repairs not performed by a Miele authorised technician will void the warranty.
- ▶ During repairs or cleaning and maintenance, the microwave oven must be disconnected from the mains power supply. It is only completely isolated from the electricity supply when:
 - the plug has been disconnected from the back of the appliance or the appliance has been switched off at the wall socket and the plug withdrawn.Do not pull the mains connection cable but the mains plug to disconnect your appliance from the mains electricity supply.
 - the mains circuit breaker is switched off.
 - the screw-out fuse is removed (in countries where this is applicable).
- ▶ The manufacturer can only guarantee the safety of the appliance when Miele replacement parts are used. Faulty components must only be replaced by genuine Miele spare parts.
- ▶ If the appliance is installed behind a kitchen furniture door, it may only be used with the furniture door open. Do not close the furniture door while the appliance is in use. Heat and moisture can build up behind the closed furniture door. This can result in damage to the appliance and furniture unit. Leave the furniture door open until the appliance has cooled down completely.
- ▶ The appliance must not be used in a non-stationary location (e.g. on a ship).

Correct use

 Danger of burning on the grill.

When grilling with or without the microwave function, the microwave oven will get hot. You could burn yourself on the oven interior walls, the grill element, food, accessories or the oven door.

Wear oven gloves when placing food in the oven or removing it, and when adjusting oven shelves etc. in a hot oven.

Warning and Safety instructions

▶ Always ensure that food is sufficiently cooked or reheated.

The time required for this depends on a number of factors, such as the nature of the food, its initial temperature, the amount to be cooked and recipe variations.

Some foods may contain micro-organisms which are only destroyed by thorough cooking at sufficiently high temperatures (over 70 °C) for long enough (a minimum of 10 minutes). Therefore when cooking or reheating foods, e.g. poultry, it is particularly important that food is fully cooked through. If in any doubt that a sufficiently high temperature has been reached, continue reheating for a little longer.

▶ It is important that the temperature in the food being cooked is evenly distributed and sufficiently high.

This can be achieved by stirring or turning the food, and observing a sufficiently long standing time (see charts) which should be added to the time needed for reheating, defrosting or cooking. During the standing time the temperature is distributed evenly in the food.

▶ Always remember that times for cooking, reheating and defrosting in a microwave oven are usually considerably shorter than with traditional methods of cooking food.

Excessively long cooking durations can lead to food drying out and burning, or could even cause it to catch fire. Fire hazard! There is also a danger of fire if breadcrumbs, flowers, herbs etc. are dried in the microwave oven. Do not dry these items in the microwave oven.

▶ Cushions or pads filled with cherry kernels, wheat grain, lavender, or gel, such as those used in aromatherapy can ignite when heated, even after they have been removed from the microwave oven. Do not heat these up in the microwave oven. Fire hazard!

▶ The microwave oven is not suitable for cleaning or disinfecting items. Items can get extremely hot and there is a danger of burning when the item is removed from the appliance. Fire hazard!

▶ The appliance can be damaged if it is used without food being placed in it or if it is incorrectly loaded. Therefore do not use the appliance to preheat crockery or to dry herbs or similar items.

▶ Always ensure that food, a gourmet plate or a browning dish has been placed in the microwave, and that the turntable is in place, before switching on.

▶ Pressure can build up when reheating food or drinks in sealed containers, jars or bottles, which can cause them to explode. Never cook or reheat food or liquids in sealed containers, jars or bottles. With baby bottles, the screw top **and** teat must be taken off.

Warning and Safety instructions

▶ Be careful when removing dishes from the appliance. Although heat is not normally produced in the container itself by the microwaves (apart from stoneware), heat transfer from the food to the container may be considerable, making the container itself hot. The dish is only warmed by the heat of the food. Before serving, always check the temperature of the food itself after taking it out of the microwave. The temperature of the container is not an indication of the temperature of the food or liquid in it.

This is particularly important when heating food for babies, children, and the elderly or infirm. After reheating food, especially food for babies and small children, stir the food or shake the container and check that the temperature does not pose any danger of burning. Double check after it has been left to stand.

▶ When heating liquids, milk, sauces etc. using microwave power, the boiling point of the liquid may be reached without the production of the typical bubbles. Liquids do not boil evenly throughout. This so-called 'boiling delay' can cause a sudden build-up of bubbles when the container is removed from the oven or shaken, which can lead to the liquid boiling over suddenly and explosively. Danger of burning and scalding!

The formation of bubbles can be so strong that the pressure forces the oven door open. Danger of injury and damage to the appliance! Stir liquids well before heating. After heating, wait at least 20 seconds before removing the container from the oven. In addition, during heating a glass rod or similar item, if available, can be placed in the container.

▶ To avoid fuelling any flames, do not open the oven door if smoke occurs in the oven interior.

Interrupt the process by switching the appliance off and disconnect it from the electricity supply.

Do not open the door until the smoke has dispersed.

▶ Oils and fats can ignite if allowed to overheat. Never leave the microwave oven unattended when cooking with oil or fats. Do not use the appliance for deep frying. Never attempt to put out oil or fat fires with water. Switch the microwave oven off and extinguish the flames by leaving the door closed.

▶ Due to the high temperatures radiated, objects left near the microwave oven when it is in use could catch fire. Do not use the appliance to heat up the room.

Warning and Safety instructions

- ▶ If using alcohol in your recipes, please be aware that high temperatures can cause the alcohol to vaporise. The vapour can catch fire on hot surfaces. Never heat undiluted alcohol in the microwave, as it can easily ignite. Fire hazard!
- ▶ Food which is stored in the oven or left in it to be kept warm can dry out and the moisture released can lead to corrosion damage in the microwave oven. This can also cause damage to the control panel, benchtop and surrounding kitchen furniture. Always cover food that is left in the oven to keep warm.
- ▶ Try to avoid the interior walls being splashed with food or liquids containing salt. If it does happen, wipe these away thoroughly to avoid corrosion on the stainless steel surface.
- ▶ The oven interior can get hot during use. Danger of burning! Clean the oven interior and accessories as soon as it has cooled down. Waiting too long can make cleaning unnecessarily difficult and in some cases impossible. Stubborn soiling could damage the microwave oven in certain circumstances and could even be dangerous. Fire hazard! Please refer to the relevant instructions in “Cleaning and care”.
- ▶ Fire hazard! Plastic containers which are not suitable for use in microwave ovens can be badly damaged and cause damage to the appliance if used. Do not use any containers or cutlery made from or containing metal, aluminium foil, lead crystal glassware, temperature-sensitive plastics, wooden utensils or cutlery, metal clips or plastic or paper covered wire ties. Do not use bowls with milled rims, or plastic pots with the foil lid only partially removed (see “Suitable containers for microwave use”).
Using these items could result in damage to the container and/or present a fire risk.
- ▶ Disposable plastic containers must be specified by the manufacturer as suitable for use in a microwave oven.
Do not leave the oven unattended when heating or cooking food in disposable containers made of plastic, paper or other inflammable materials.
- ▶ Heat-retaining packaging consists of, among other things, a thin layer of aluminium foil. Microwaves are reflected by metal. This reflected energy can, in turn, cause the outer paper covering to become so hot that it ignites.
Do not use heat-retaining packaging for warming food in the microwave oven, such as bags for grilled chicken.

Warning and Safety instructions

- ▶ If you cook eggs without their shells using microwave power, the yolks could explode due to the resulting pressure. Prick the yolk several times before cooking to avoid this.
- ▶ Eggs heated in their shells using microwave power can burst, even after they have been taken out of the oven. Eggs can only be cooked in their shells in a specially designed egg-boiling device. Do not reheat hard-boiled eggs in the microwave oven.
- ▶ Food with a thick skin or peel, such as tomatoes, sausages, potatoes and aubergines can burst when heated. Pierce or score the skin of these types of food several times to allow steam to escape.
- ▶ Dishes with hollow knobs or handles are not suitable for use in a microwave oven. Moisture which has gathered in the hollow recesses can cause pressure to build up and the items can explode (this risk is reduced if the hollow recess is sufficiently ventilated). We recommend that you do not use such dishes in the microwave oven.
- ▶ Do not use a thermometer containing mercury or liquid as these are not suitable for use with very high temperatures and break very easily.
To check food temperature, first interrupt the cooking process. Only use a thermometer specifically approved for food use to measure the temperature of the food.
- ▶ The steam from a steam cleaner could reach electrical components and cause a short circuit. Do not use a steam cleaner to clean the appliance.

The following applies for stainless steel surfaces:

- ▶ The coated stainless steel surface can be damaged by adhesives and will lose its dirt-repelling properties. Do not use sticky notes, adhesive tape or other types of adhesive on the stainless steel surface.
- ▶ The surface is susceptible to scratching. Even magnets can cause scratches.

Accessories

- ▶ Only use original Miele accessories. If other parts are used, warranty, performance and product liability claims will be invalidated.
- ▶ Miele will guarantee to supply functional spare parts for a minimum of 10 years and up to 15 years following the discontinuation of your microwave oven.
- ▶ The rack and gourmet plate supplied are designed for use with microwave power and can be used for grilling with or without the microwave function. They must not, however, be used at the same time, as this would damage the gourmet plate. Always place the gourmet plate directly on the turntable.
- ▶ The gourmet plate gets extremely hot when in use. Always use oven gloves when handling it to avoid burns. Place it on a suitable heat-resistant mat or pot rest. The rack and the gourmet plate get hot during grilling (with or without the microwave function).
Danger of burning!
Do not place the hot gourmet plate (or any other hot cooking container) on a cold surface, such as a tiled or granite benchtop. The glass tray or container could crack or shatter. Use a suitable heat-resistant mat or pot rest.
- ▶ Do not use the gourmet plate together with a commercially available microwave cover because the cover would become too hot.

Before using for the first time

After unpacking, let the appliance stand for approx. 2 hours at room temperature after transporting it to its final location before connecting it to the electricity supply.

This is to allow time for the temperature to equalise between the temperature in the room and the appliance. This is important for the correct electronic functioning of the appliance.

 Risk of suffocation from packaging material.

Whilst playing, children may become entangled in packaging material (such as plastic wrapping) or pull it over their head with the risk of suffocation.

Keep packaging material away from children.

- Remove all packaging materials from the appliance.

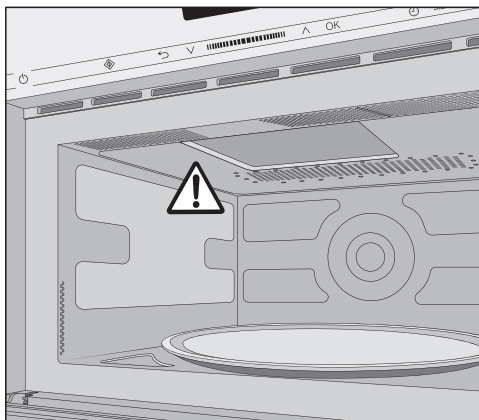

Do not remove the cover of the microwave outlet inside the oven.

- Check the appliance for any damage.

 Danger to health due to a defective device.

Operating a damaged appliance can result in microwave leakage and present a hazard to the user.

Do not use the appliance if

- the appliance door is warped.
- the door hinges are loose.
- holes or cracks are visible in the casing, the door or the oven interior walls.

- Clean the inside of the microwave oven and all the accessories with a soft sponge and warm water.

When building in the appliance, ensure that there is adequate ventilation to the front of the appliance.

Do not obstruct the air vents with any objects.

Lifting the microwave oven by the door handle could cause damage to the door.

Use the handle cut-outs on the side of the housing to lift the appliance.

Building-in dimensions

Dimensions are given in mm.

Installation

Tall unit installation

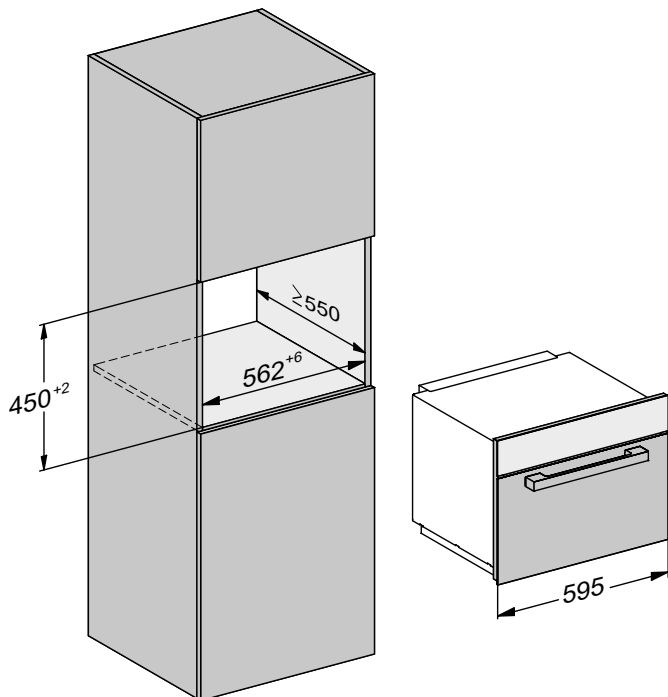

Base unit installation

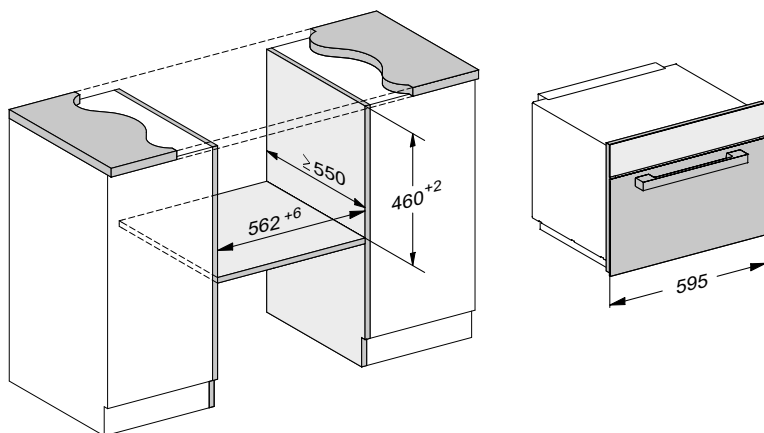

Side view

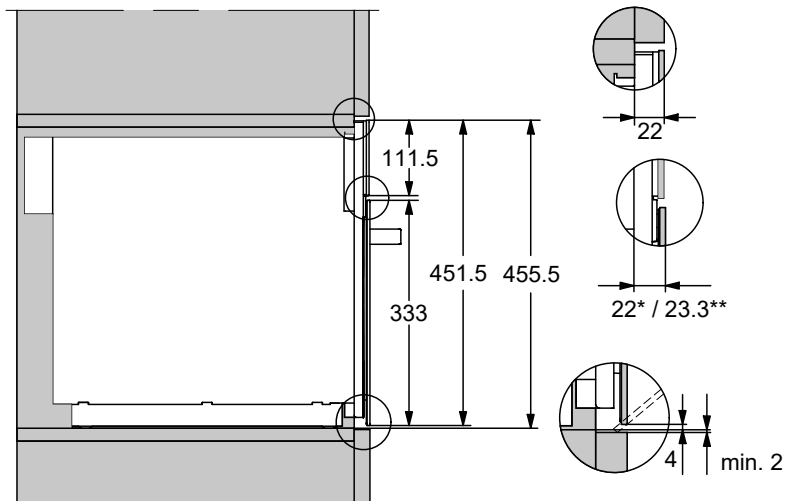

* Glass

** Stainless steel

Base unit connection

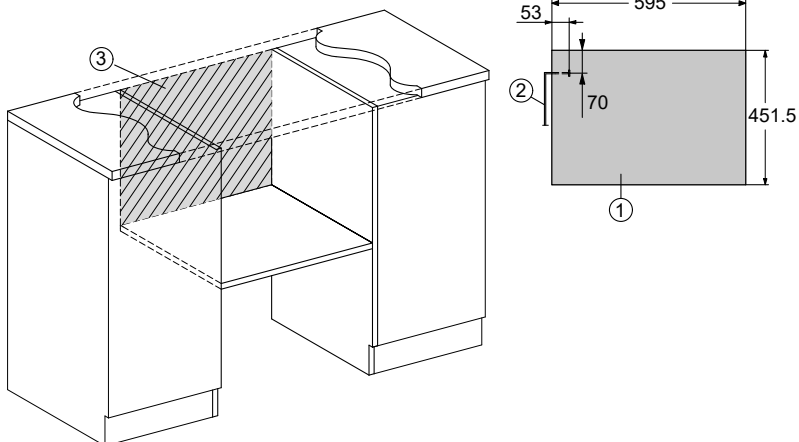

① Front view

② Mains connection cable,
length = 1,600 mm

③ No connections permitted in this area

Installation

Tall unit connection

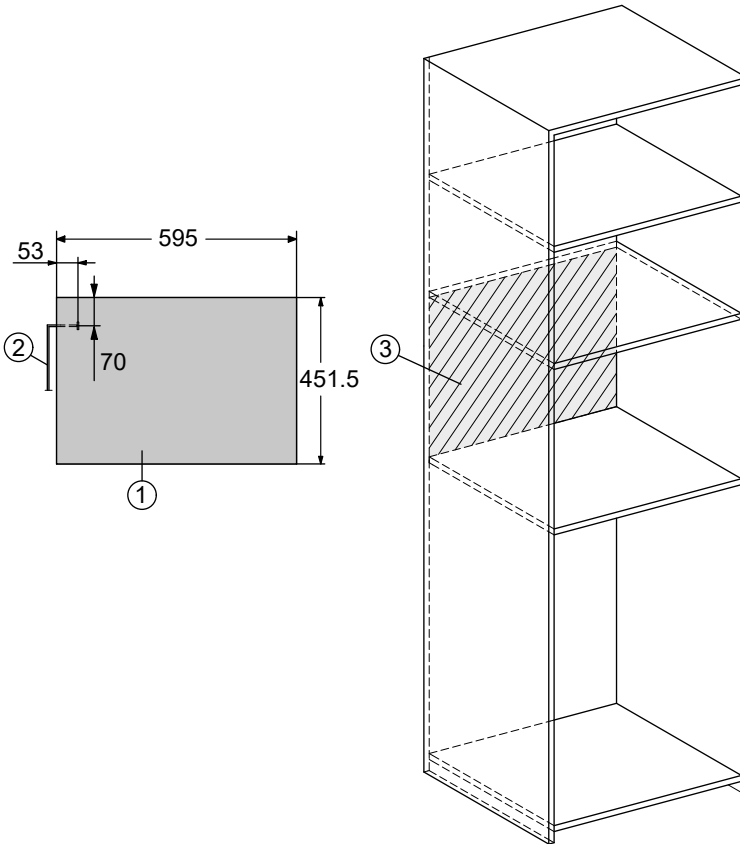

- ① Front view
- ② Mains connection cable, length = 1,600 mm
- ③ No connections permitted in this area

Carrying out installation

The appliance must be built in before it can be used.

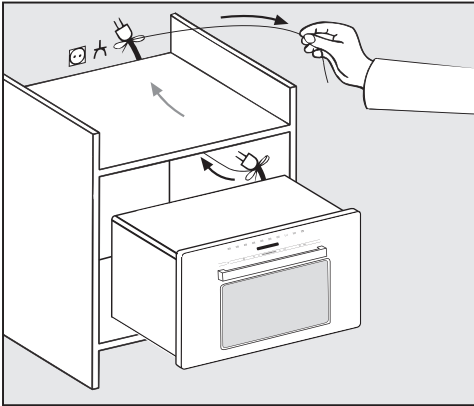

- Slide the appliance into the niche. Feed the cable with the plug through the back of the furniture unit.

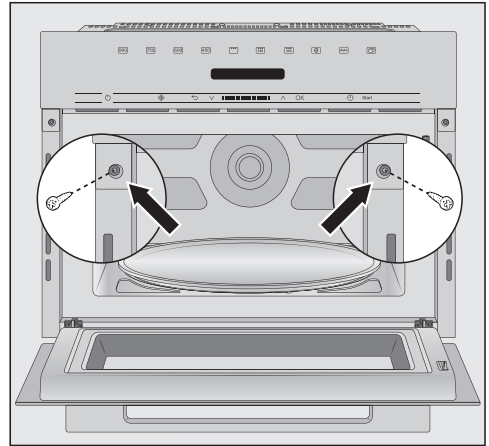

- Align the appliance.
- Open the appliance door and secure the appliance into the side walls of the furniture unit using the screws provided.

Installation

Electrical connection

 Danger of injury due to a defective appliance.

Before connecting the appliance, ensure that it has not been damaged in any way.

Do not use a damaged appliance.

The appliance is supplied with a power cord and plug for connection.

Make sure that the earthed socket is freely accessible at all times. If the switch is not accessible after installation an additional means of disconnection must be provided for all poles.

 Risk of fire from overheating.

Connecting the appliance to a multi-socket plug adapter or to an extension lead can overload the cable.

The appliance must not be used with so-called energy saving devices either. These reduce the amount of energy supplied to the appliance, causing it to overheat.

Do not use an extension lead or multi-socket plug adapter.

Connect the appliance directly with the original cable without any intermediate elements.

The electrical system must comply with the applicable standards and with local and national regulations.

If the connection cable is damaged, it must only be replaced with a specific connection cable of the same type (available from Miele) in order to avoid a hazard. For safety reasons, such replacement may only be carried out by a qualified and competent technician or Miele.

The connection data can be found on the data plate located on the front of the oven interior or on the back of the appliance.

Compare the specifications on the data plate with those of the mains electricity supply. The data must match.

If in any doubt, consult a qualified electrician.

Temporary or permanent operation with a self-sufficient or non-mains synchronous energy supply system (e.g. isolated networks, back-up systems) is possible. A requirement for the operation is that the energy supply system complies with all current local and national requirements that apply to stand-alone, solar and/or battery systems.

The protective measures provided in the domestic installation and in this Miele product must also be assured in their function and operation in isolated operation or in non-mains synchronous operation, or replaced with equivalent measures in the installation.

Disposal of the packing material

The transport and protective packaging has been selected from materials which are environmentally friendly for disposal, and can normally be recycled.

Recycling the packaging reduces the use of raw materials in the manufacturing process and also reduces the amount of waste in landfill sites.

Ensure that any plastic wrappings, bags etc. are disposed of safely and kept out of the reach of babies and young children. Danger of suffocation.

Only for Australia: Note for installer: Expanded polystyrene (EPS) packaging included. Please retain and dispose of EPS packaging responsibly. For further information, please contact Miele.

Disposing of your old appliance

Electrical and electronic appliances often contain valuable materials. They also contain specific materials, compounds and components, which were essential for their correct function and safety. These could be hazardous to human health and to the environment if disposed of with your domestic waste or if handled incorrectly. Please do not, therefore, dispose of your old appliance with your household waste.



Please dispose of it at your local community waste collection / recycling centre for electrical and electronic appliances. You are also responsible for deleting any personal data that may be stored on the appliance prior to disposal. Please ensure that your old appliance poses no risk to children while being stored prior to disposal.

Guide to the appliance

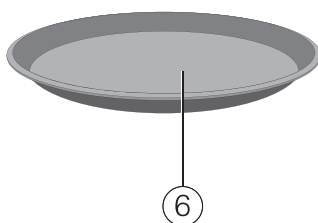
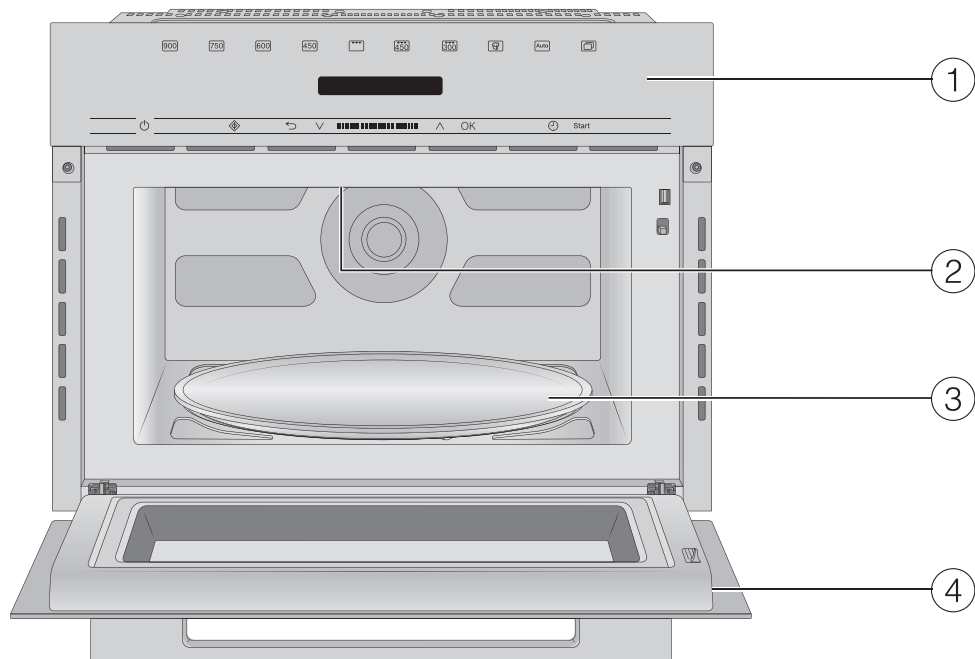

- ① Control panel
- ② Grill
- ③ Turntable
- ④ Door
- ⑤ Grilling rack
- ⑥ Gourmet plate

Grilling rack

The grilling rack can be used for all functions with and without microwave power, **except** for Microwave Solo mode.

To avoid the grilling rack being used inadvertently with Microwave Solo mode, it should not be stored inside the microwave oven.

Gourmet plate

The gourmet plate is a round, non-stick grilling plate. It can be used to heat snacks or small meals quickly whilst maintaining crispness.

Useful tip: These products and others can be ordered from the Miele online shop.

They can also be ordered directly from Miele (see the end of this booklet for contact details).

On/Off sensor

The On/Off  sensor control is recessed and reacts to touch.

It switches the microwave on and off.

Display

The display is used for showing the time of day or information about functions, temperatures, cooking durations, Automatic programmes and settings.

After switching the microwave oven on with the On/Off  sensor, the main menu will appear with the prompt **Select** function.

Sensor controls

The sensors react to touch. Every touch of the sensors is confirmed by an audible tone. You can switch off this keypad tone by selecting the **Volume** setting and then selecting **Keypad tone** and lowering the volume all the way down with the arrow sensors.

If the display is dark, the sensors will not react until the microwave oven is switched on.

Sensor controls above the display

Here you will find the operating modes and the further functions of the microwave oven.

Operating mode/function

 Power level 900 Watt

 Power level 750 Watt

 Power level 600 Watt

 Power level 450 Watt



 Grill

 Combination mode
450 Watt + Grill

 Combination mode
300 Watt + Grill

 Popcorn

 Automatic programmes

 Further
(programmes and Settings )

300 W

150 W

80 W

Grill + 150 W





Defrost

Reheat

Settings 







Controls

Sensor controls under the display

Sensor	Function
	Use this sensor control to start the Quick MW function. The cooking process runs at the maximum power level (900 W) and a cooking duration of one minute (see “Operation - Selecting Quick microwave”). Touching the sensor control repeatedly increases the cooking duration in increments.
	Depending on which menu you are in, this sensor control will take you back a level or back to the main menu. If a cooking process is in progress, you can stop the cooking process with this sensor and cancel it by touching the sensor again.
	In the navigation area, use the arrow sensors or the area between them to scroll up and down in the selection lists. The display shows the menu option that you want to select. You can change the values and settings using the arrow sensors or the area between them.
<i>OK</i>	A function that appears in the display can be selected with <i>OK</i> . The selected function can then be changed. Confirm with <i>OK</i> to save changes. If information appears in the display, select <i>OK</i> to confirm the message.
	You can use this sensor to set a minute minder (e.g. for boiling eggs) at any time, even when a cooking process is in progress. You can also use this sensor to programme cooking durations.
Start	Use this sensor to start a cooking process.

Display symbols

The following symbols may appear in the display:

Symbol	Meaning
	This symbol indicates that there is additional information and advice about using the appliance. Select <i>OK</i> to access the information.
	This indicates that there are more options available, which are not visible because there is not enough space in the display.
	Some settings, e.g. display brightness and signal tone volume, are selected using a segment bar.
	A tick next to a setting indicates that this option is currently selected.
	The system lock is switched on (see “Settings - Safety”). The controls are locked.
	Minute minder

Operating principles

Selecting a menu item or changing a value or setting

The arrow sensors \wedge and \vee and the area between them  have the following functions:

- They select a menu item in a selection list.
- They change a value (e.g. the weight of the food) or a setting (e.g. the volume of the signal tone).
- Touch the applicable arrow sensor or swipe to the right or left in the area between the arrow sensors until you reach the desired menu option.

Useful tip: If you hold down the arrow sensor, the selection list or the values continue to scroll automatically until you release the arrow sensor.

- Confirm your selection with *OK*.

The current setting is marked with a \checkmark .

Selecting the operating mode or function

The sensors for the operating modes and functions (e.g. settings) are located above the display. An operating mode or function is selected with the corresponding sensor on the control panel (see “Operation” and “Settings”).

- Touch the sensor control of the required operating mode or function.

The sensor on the control panel will light up orange.

- Set the values or scroll through the selection lists until the required setting appears.

Cancelling cooking

You can cancel a cooking process using the function sensor control that lights up orange or using the \curvearrowright sensor.

- Touch the sensor control for the operating mode, or the \curvearrowright sensor twice to cancel the cooking process.
- If you have set a cooking duration, select *Cancel process* and confirm with *OK*.

The main menu will appear.

Description of the functions

In a microwave oven there is a high-frequency tube called a magnetron. This converts electrical energy into electromagnetic waves (microwaves). These microwaves are distributed evenly throughout the oven interior, and are reflected off the metal appliance walls. This enables the microwaves to reach the food from all sides and heat it up. Microwave distribution is improved with the turntable engaged.

In order for microwaves to reach the food, they must be able to penetrate the cooking container being used.

Microwaves can pass through porcelain, glass, cardboard and plastics, but not metal. Therefore do not use utensils that are made of metal or contain metal, for example in the form of gold or silver trim. The metal reflects the microwaves and this could lead to the creation of sparks. The microwaves cannot be absorbed.

Microwaves pass through a suitable container and into the food. All food contains water molecules which, when subjected to microwave energy, start to oscillate 2.5 billion times a second. This vibration creates heat. It first starts developing around the outside of the food and then slowly penetrates towards the centre. The more water a food contains, the faster it is heated or cooked.

The heat is produced directly in the food. This has the following advantages:

- Food can generally be cooked without adding liquid or cooking oil, or with just a little water or oil.
- Cooking, reheating and defrosting in a microwave oven is quicker than using conventional methods.
- Nutrients, such as vitamins and minerals, are generally retained.

– The colour, texture and taste of food are not impaired.

Microwaves stop being produced as soon as the cooking process is interrupted or the appliance door is opened. When the appliance is in operation, the closed, sealed door prevents microwaves escaping from the appliance.

Modes of operation

In the microwave oven, food is cooked, reheated or defrosted quickly.

You can use the microwave oven in the following ways:

- Food can be defrosted, reheated or cooked by entering a power level and a duration.
- Deep-frozen, ready-made meals can be defrosted and then heated or cooked.
- The microwave oven can also be used for other tasks, e.g. for proving yeast dough, melting chocolate and butter, dissolving gelatine, preparing cake icing, and preserving small amounts of fruit, vegetables and meat.

Functions

Microwave Solo mode

Suitable for defrosting, reheating and cooking.

Grilling

Ideal for grilling thin cuts of meat, e.g. steak or sausages.



Combination mode (Microwave + Grill)

Ideal for browning dishes with toppings. The microwave cooks the food, and the grill browns it.

Automatic programmes

You can choose from the following Automatic programmes:

You can choose from four different categories of Automatic programmes.

- Cook 
- Defrost
- Reheat
- Popcorn 

The programmes are weight-dependent. You can specify the weight of food in grams (g), pounds (lb) or pounds/ounces (lb/oz) (see “Settings - Changing settings”).

Suitable containers for microwave use

Microwaves

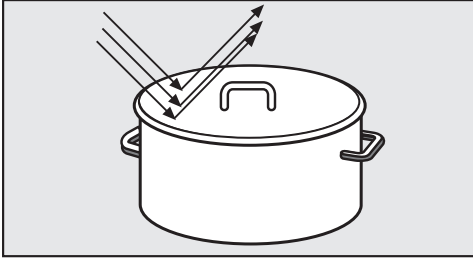

- are reflected by metal,

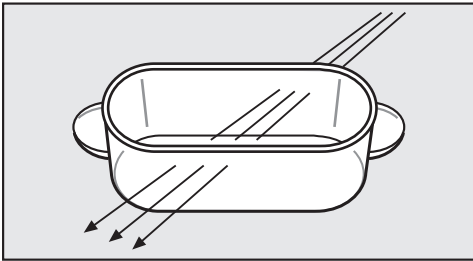

- pass through glass, porcelain, plastic and cardboard,

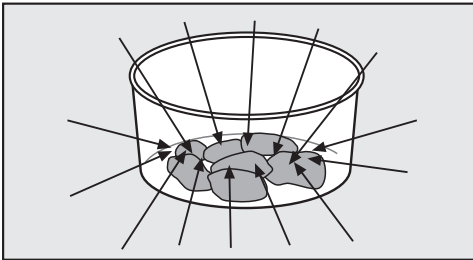

- and are absorbed by food.

⚠ Risk of fire due to unsuitable crockery.

Containers which are not suitable for use in microwave ovens can be badly damaged and cause damage to the appliance if used.

Please observe the information on suitable containers for microwave use.

Material and shape

The material and shape of containers used affect cooking results and times. Heat distribution is more even in round and oval shaped flat containers than in rectangular containers, providing better results.

⚠ Risk of injury due to hollow handle parts and lid knobs. Moisture can penetrate hollow handles and lid knobs of crockery. This can lead to a build-up of pressure, which can cause the hollow parts to crack or shatter with the danger of injury. Do not use crockery with hollow handles or lid knobs, unless the hollow parts are sufficiently vented.

Metal

Metal containers, aluminium foil, metal cutlery, and china with metallic decoration such as gold rims or cobalt blue must not be used with microwave mode. Metal reflects microwaves and obstructs the cooking process.

Do not use containers where the foil lid has not been completely removed as small pieces of foil can cause sparking.

Exceptions:

- Ready-meals in aluminium foil dishes
These can be defrosted and reheated in the microwave oven, if recommended by the manufacturer. Important: Remove the lid and make sure the foil dish is at least 2 cm from the oven walls at all times. However, food is only heated from the top. Transferring the

Suitable containers for microwave use

food from the aluminium foil container to a dish suitable for microwave use will result in a more even heat distribution.

Do not place aluminium foil dishes on the rack, in case the dish sparks or arcs.

- Pieces of aluminium foil
For even defrosting and to avoid overcooking unevenly shaped cuts of meat, poultry or fish, small pieces of aluminium foil may be used to mask wingtips or other thin parts for the last few minutes of the programme.

Make sure that the aluminium foil is at least 2 cm from the oven walls at all times. It must not touch the walls.

- Metal meat skewers or clamps
These should only be used if they are very small in comparison to the size of the cut of meat.

Glazes and colours

Some dishes have glazes and colours containing metallic substances. These dishes are unsuitable for microwave use.

Glassware

Heat-resistant glass or ceramic glass is ideal for use in the microwave oven.

Crystal glass is unsuitable as it usually contains lead which could cause the glass to crack in the microwave.

Porcelain

Porcelain is a suitable material.

However do not use porcelain with gold or silver edging, or items with hollow knobs or handles.

Earthenware

Decorated earthenware is only suitable if the decoration is beneath an all-over glaze.

Earthenware can get very hot and may crack.

Wear oven gloves when removing the dishes from the oven.

Wood

Water contained in wood evaporates during the cooking programme. This causes the wood to dry and crack.

Wooden dishes are therefore not suitable.

Plastics

 Damage caused by heat-sensitive plastics.

Plastics must be heat-resistant to a minimum of 110 °C. Otherwise the plastic may melt and fuse with the food.

Use plastic containers only with Microwave Solo mode.

Special plastic utensils designed for use in microwave ovens are available from retail outlets.

Melamine containers are not suitable. They absorb energy and become hot.

When purchasing plasticware, make sure that it is suitable for use in a microwave oven.

Disposable containers, such as trays made from polystyrene, can only be used for very short, timed warming and reheating of food.

Suitable containers for microwave use

Plastic boiling bags can be used for cooking and reheating. They should be pierced beforehand to allow the steam to escape. This prevents a build-up of pressure from forming and the bag from bursting.

There are also special bags available for steam cooking which do not need to be pierced. Please follow the instructions given on the packet.



Risk of fire due to unsuitable material.

Do not use metal clips, plastic clips containing metal parts, or paper ties containing wire.

There is a danger that they will ignite when heated.

Disposable containers

Disposable plastic containers must have the characteristics listed under "Plastics".



Risk of fire due to unsuitable crockery.



Disposable containers made out of plastic, paper or other inflammable materials can ignite.

Do not leave the appliance unattended when reheating or cooking food in disposable containers made of plastic, paper or other inflammable materials.

To protect the environment we do not recommend the use of single-use containers.

Testing containers

If in doubt as to whether glass, earthenware or porcelain plates or dishes are suitable for use in a microwave oven, a simple test can be performed:

- Place the item you wish to test in the centre of the oven.
- Close the door.
- Touch the  sensor.
- Select the 900 Watt power level.
- Enter 30 seconds using the  and  arrow sensors and confirm the entry with *OK*.
- Touch the start sensor to start the test.

If a crackling noise is heard during the test accompanied by sparks, switch the appliance off immediately (touch  and confirm with *OK*)! Any crockery which causes this reaction is unsuitable for use with microwave power. If any doubt exists about the suitability of containers, please contact the manufacturer or supplier.

This test cannot be used to check whether items with hollow knobs or handles are suitable for microwave use.

Suitable containers for microwave use

A microwave lid or cover

- prevents too much steam escaping, especially when cooking foods which need longer to cook, such as potatoes.
- speeds up the cooking process.
- prevents food from drying out.
- helps keep the oven interior clean.

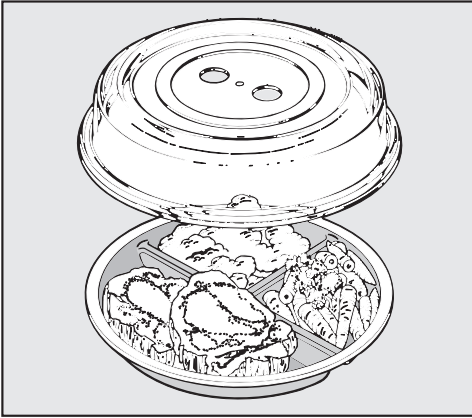

- When using Microwave Solo, always cover food with a microwave-safe lid.

Suitable covers are available from retail outlets.

Alternatively, you can use cling film recommended for use in a microwave oven by the manufacturer. Normal cling film may distort with the heat and fuse with the food.

 Damage caused by heat-sensitive plastics.

The material of the microwave cover must be able to withstand temperatures of up to 110 °C (see manufacturer information). At higher temperatures the plastic may distort and fuse with the food.

Therefore the cover must only be used in microwave ovens and only with Microwave Solo mode without the gourmet plate.

 Damage due to covered openings.

If a lid is used with a container which only has a narrow diameter, the cover could form a seal around the container and there might not be enough room for condensation to escape through any holes in the top. The cover could get too hot and start to melt.

Make sure that the cover does not form a seal.

Do not use a lid or cover when

- cooking food coated with breadcrumbs.
- cooking meals which are to be given a crisp finish, such as toast.
- the gourmet plate is being used.

 Risk of explosion due to pressure build-up.

Pressure can build up when reheating food or drinks in sealed containers, jars or bottles, which can cause them to explode.

Sealed glass containers, such as jars of baby food, must be opened before they are placed in the microwave. Do not attempt to heat them up unopened. With baby bottles, the screw top and teat must be taken off.

Before using for the first time

The appliance must be built in before it can be used.

When the microwave is connected to the mains electricity, it is immediately ready for use.

Welcome screen

The Miele logo appears. You will then be requested to select some basic settings which are needed before the microwave oven can be used.

- Follow the instructions in the display.

Setting the language

- Use the arrow sensors to select the language.
- Confirm with *OK*.

If you have accidentally selected a language that you don't understand, proceed as described in "Settings – Language".

Setting the country

- Use the arrow sensors to select the country.
- Confirm with *OK*.

Setting the time of day

- Use the arrow sensors to set the time of day.
- Confirm with *OK*.

The display message *Clock display off* is marked with a ✓.

- Confirm with *OK*.

The information *Energy consumption* - appears in the display because energy is saved when the time of day display is switched off.

- Touch *OK*.

Set-up finished appears in the display.

- Confirm with *OK*.

Select function appears in the display.

The time of day display is set at the factory to run in the background. The display switches off and goes dark to save energy.

You can change this setting if you want to see the time of day at all times (see "Settings - Changing settings").

When the time of day is visible, all sensor controls immediately react to touch.



When the display is dark, the appliance is switched off. The appliance must be switched on using the On/Off  sensor before it can be used again.

Useful tip: The time of day can be displayed in 12-hour format (see "Settings – Time – Clock Format").

Altering the time of day

- Switch on the appliance with the On/Off  sensor.

Select function appears in the display.

- Touch the  sensor.
- Select the submenu *Settings*  using the arrow sensors and confirm with *OK*.
- Then select the submenu *Time* using the arrow sensors and confirm with *OK*.
- Select *Set* using the arrow sensors and confirm with *OK*.





The current time of day is highlighted in white in the display.

- Change the time of day using the arrow sensors and confirm with *OK*.
- Touch the  sensor repeatedly to return to the first level.

Select function appears in the display.

Settings

Settings overview

Menu option	Available settings
Language 	...deutsch*, english... Country
Time	Display (Clock display off*, Clock display on, Night dimming) Clock format (24 h*, 12 h) Set
Volume	Buzzer tones  Keypad tone 
Display brightness	
Units	Weight (g*, lb, lb/oz)
Keeping warm	On*, Off
Quick MW	Power level (...900 W*, 750 W, ...) Duration (01:00*, customisable)
Popcorn	Duration 03:20*, customisable between 2:30 and 3:50 min
Oven compartment query	On*, Off
Safety	Sensor lock (Off*, On) System lock  (Off*, On)
Software version	
Showroom programme	Demo mode (Off*, On)
Factory default	Do not reset, Reset





* Factory default setting

Changing settings

You can select an alternative for some settings of your appliance.

Please consult the chart for the individual settings that can be changed. The factory settings are marked with an asterisk * in the chart.

To change a setting, proceed as follows:

- Touch the  sensor.
- Select Settings  using the arrow sensors.
- Confirm your selection with *OK*.
- You can now select the options listed in the chart using the arrow sensors. Confirm the desired item with *OK*.
- Depending on the menu option, you can now enter values or select one of the sub-items with the arrow sensors.
- Touch  if you do not want to change a setting and want to switch to another.
- Touch  when you have finished changing settings.



The altered settings are retained after a power cut.

Language

You can set the language and the country.

The country can be selected if there are different countries and language variants available for the selected language.



After selecting and confirming your choice, the language you have selected will appear in the display.

Useful tip: If you have selected the wrong language by mistake, select . Follow the  symbol to get back to the Language  submenu.

Time

Display

Select the time of day display for when the microwave oven is switched off:

-  On
The time always appears in the display. All sensor controls react to touch immediately.
-  Off
The display is dark to save energy. The appliance needs to be switched on before it can be used.
- Night dimming
To save energy, the time is only visible in the display between 5:00 am and 11:00 pm. The display remains dark at the other times. The appliance needs to be switched on before it can be used.

Clock format

The time of day can be displayed in the 24 or 12-hour format.

Set

Set the hours and then the minutes.

If there is a power cut, the current time of day will reappear once power has been restored. The time of day is saved for approx. 150 hours.

Volume

The volume of the signal tones is represented by a segment bar.

-  maximum volume

-  The tone is switched off.

Settings

Buzzer tones

If signal tones are switched on, a tone will sound when the set temperature is reached and at the end of a set time.

Keypad tone

When the keypad tones are switched on, a tone sounds when a sensor is touched.

Display brightness

The display brightness is represented by a segment bar.

- ■■■■■■■■
maximum brightness
- ■■■■■■■
minimum brightness

Units

Weight

For Automatic programmes, you can set the weight of food in grams (g), pounds (lb) or pounds/ounces (lb/oz).

Keeping warm

The keeping warm function Keeping warm will switch on automatically after the end of a cooking programme which has used at least 450 W, providing the door remains closed and no sensors are pressed.

After approx. 2 minutes, the food will be kept warm using 80 W for a maximum period of 15 minutes.

- On
The Keeping warm function is switched on.
- Off
The Keeping warm function is switched off.

Quick MW

Touching the  sensor is sufficient to set the appliance operating at maximum power for 1 minute.

Power and duration can be modified.

This means a frequently used cooking process can be saved in this programme space.

- Power level
All available power levels can be selected.
- Duration
At the maximum power level, a maximum cooking duration of 5 minutes can be programmed; for other levels, a maximum cooking duration of 10 minutes.

Popcorn

This programme is suitable for making microwave popcorn.

The factory setting of 3:20 minutes can be changed.

It can be set between 2:30 and 3:50 minutes.

Oven compartment query

The food prompt is a reminder that the appliance should not be used without food inside it.

Operating the appliance without food can damage the appliance.

If a cooking programme is started without the door having first been opened, the prompt Food in oven? will appear in the display.

It is possible that there is no food inside the appliance because the door has not been opened recently (in the last 20 minutes).

The programme only starts after confirming with *OK* or after the door has been opened.

Safety

System lock

The system lock prevents the appliance being used unintentionally, for example by children.

The minute minder can still be set when the system lock is on.

The system lock will remain switched on even after a power outage.

- On
The system lock is switched on. Before you can use the microwave oven, you need to switch it on and touch *OK* for at least 6 seconds.
- Off
The system lock is deactivated. You can use the microwave oven as normal.

Sensor lock

The sensor lock prevents the microwave being switched off or a cooking programme being altered by accident. Once activated, the sensor lock prevents all sensor controls and fields in the display from working a few seconds after a programme has been started.

- On
The sensor lock is switched on. Before you can use a function, touch *OK* for at least 6 seconds. The sensor lock is then deactivated for a short time.
- Off
The sensor lock is deactivated. All sensor controls react to touch as normal.

Software version

The software version menu option is for use by Miele service technicians. You do not need this information for domestic use.

Showroom programme

This function enables the microwave oven to be demonstrated in showrooms without heating up. Do not activate this setting for domestic use.

Demo mode

If you switch the microwave oven on while demo mode is activated, the message *Demo mode* will appear in the display. The appliance does not heat up.

- On
Touch *OK* for at least 4 seconds to activate demo mode.
- Off
Touch *OK* for at least 4 seconds to deactivate demo mode.
The microwave oven is fully functional again.

Factory default

One setting can be used to reset all the changes made to the initial state of the microwave oven.

- Do not reset
All changes made are retained.
- Reset
All settings are reset to the factory default settings.

Operation

Opening the door

If the microwave oven is being used, opening the door will interrupt the cooking programme.

 Risk of injury from the open door.

The oven door can support a maximum weight of 8 kg. Children could injure themselves on an open door.

Do not let children sit on the door, lean against it or swing on it.

Placing a dish in the oven

Ideally the dish should be placed in the middle of the oven compartment.

Turntable

The turntable helps the food to cook, reheat or defrost evenly.

Do not operate the microwave without the turntable in place.

The turntable starts turning automatically when the appliance is operated.

Do not cook, reheat or defrost food directly on the turntable. Check that the dish is not larger in size than the turntable.

Turn or stir food during cooking, or turn the dish so that it heats up evenly.

Closing the door

If the door has been opened during a cooking process, touch Start to resume cooking.

Starting a programme

The microwave power level is selected by touching the corresponding sensor control.

- Touch the sensor for the required power level.

The sensor on the control panel will light up orange.

- Use the arrow sensors to set the cooking duration you want and confirm your selection with *OK*.

- Touch the Start sensor.

The cooking programme starts.

You can choose between 7 power levels. The higher the power level, the more microwaves reach the food.

When heating up food which cannot be stirred or turned during cooking, as with a plated meal, it is best to use a lower microwave power level.

This ensures the heat is distributed evenly. Heat for long enough to cook the food properly.

The time required depends on:

- the initial temperature of the food.
Food taken straight from the refrigerator takes longer to cook than food which has been kept at room temperature.
- the type and texture of the food. Fresh vegetables contain more water and cook more quickly than stored vegetables.
- the frequency of stirring or turning the food.
Frequent stirring or turning heats the food more evenly, and it is therefore ready in a shorter time.
- the amount of food.
As a general rule, allow approx. time and a half for double the quantity. For a smaller quantity, shorten the duration accordingly.
- the shape and material of the container.

Food in oven?

The message **Food in oven?** is a reminder that the appliance should not be used without food inside it.

Operating the appliance without food can damage the appliance.

If the Start sensor is touched without the door having first been opened, **Food in oven?** will appear in the display. It is possible that there is no food in the appliance because the door has not been opened for quite some time. Start is blocked until the door is opened.

Interrupting or restarting a programme

At any time you can . . .

. . . **interrupt a programme:**

- Open the appliance door.

The time stops counting down.

Close the door appears in the display.

. . . **continue a programme:**

- Close the door and touch the Start sensor.

The programme will continue.

Altering settings

If you discover after starting a programme that . . .

. . . the **microwave power level** is too high or too low, you can

- select a new level.

. . . the **duration** set is too short or too long, you can

- change the time using the arrow sensors and continue the programme (by touching the start sensor).

Cancelling a programme

- Touch the ↶ sensor twice or touch the selected power level.

Cancel process appears in the display.

- Confirm with *OK*.

At the end of a programme

A signal tone will sound when the cooking programme is finished. The oven interior lighting goes out.

The signal tone is repeated several times. **Finished** appears in the display.

- Touch the sensor for the selected power level to confirm.

Operation

Keeping warm

The Keeping warm function switches on automatically at the end of a cooking programme which has used at least 450 W, providing the door remains closed and no sensors are pressed. After approx. 2 minutes, the food will be kept warm using 80 W for a maximum period of 15 minutes.

Keeping warm appears in the display.

Opening the door or operating one of the sensors cancels the function.

The Keeping warm function cannot be selected as a separate function.

You can deselect this function (see "Settings").

Programming cooking durations

Cooking results can be adversely affected if there is a long delay between the food being placed in the oven and the start of cooking. Fresh food can change colour and even spoil. Select as short a time as possible until the start of the cooking process.

You can switch the cooking programme on or off automatically by entering a time for Finish at or Start at.

- Finish at
Specify when you want the cooking programme to end. The microwave oven will then switch off automatically at this time.
- Start at
Specify when you want the programme to start. The microwave oven will then switch on automatically at this time.
- Place the food in the oven.
- Select the function you want.
- Set the cooking duration and confirm with *OK*.

- Touch the  sensor.
- Select Finish at or Start at using the arrow sensors and confirm with *OK*.
- Specify the time that you want the cooking programme to start or end using the arrow sensors and confirm with *OK*.

Start at and the start time appear in the display.

Selecting Quick microwave



Touching the  sensor is sufficient to set the appliance operating at maximum power for one minute.

- Touch the  sensor.

If no further selection is made, the microwave will operate at maximum power for one minute.

Changing the duration and power level

You can change the preset duration and power level and save this as one of your main applications.

- Select .
- Select Settings  and confirm with *OK*.
- Select Quick MW and confirm with *OK*.
- Select Power level.

Power level and the saved power level appear in the display.

- If you want to change the power level, confirm with *OK*.

The saved power level is marked with .

- Change the power level using the arrow sensors and confirm the selection with *OK*.
- Then use the arrow sensors to select Duration and touch *OK*.

- Use the arrow sensors to set the cooking duration you want and confirm with *OK*.

The display will show Duration and the selected time.

- Touch  repeatedly to return to the main menu.



The modified power level and the modified time are now saved and are selected when the  sensor is touched.

The altered cooking durations you have programmed are stored in the event of a power failure and do not have to be re-entered.

System lock

The system lock prevents the appliance being used unintentionally, for example by children.

Activating the system lock

- Select .
- Select Settings  and confirm with *OK*.
- Select Safety and confirm with *OK*.
- Select System lock  and then *OK*.
- Select On and then *OK*.
- Switch the appliance off to activate the system lock.

The appliance functions are now locked and can only be used if the system lock is deactivated.

Only the minute minder can be used when the system lock is activated (see “Using the minute minder”).

The system lock will remain switched on even after a power outage.

Interrupting the system lock

You can deactivate the system lock temporarily.

- Switch on the appliance with the On/Off  sensor.

System lock  appears in the display.

- Confirm with *OK*.

Press OK for 6 seconds appears in the display.

- Follow the prompt in the display.

The time is shown counting down in the display.

The system lock is then suspended.

- Enter the cooking programme you want. All sensors and programmes can be selected freely until the appliance is switched off.

The system lock is only reactivated after the appliance is switched off.

Cancelling the system lock

- Switch on the appliance with the On/Off  sensor.

System lock  appears in the display.

- Confirm with *OK*.

Press OK for 6 seconds appears in the display.

- Follow the prompt in the display.

The time is shown counting down in the display.

The system lock is then deactivated.

- Select .

- Select Settings  and confirm with *OK*.

- Select Safety and confirm with *OK*.

- Select System lock  and then *OK*.

- Select Off and then *OK*.

- Switch off the appliance.

The system lock is now deactivated. The appliance functions are available to use again.

Operation

Using the minute minder

The minute minder can be used to time any activity in the kitchen, e.g. boiling eggs. The set time counts down in seconds.

The minute minder can also be used at the same time as a cooking programme for which automatic switch-on and switch-off times have been set (e.g. as a reminder to season the food part way through cooking).

- Touch .

Min. minder appears in the display.

- Use the arrow sensors to set the required minute minder and confirm with *OK*.

 lights up in the display and the time is counting down.

A signal tone will sound after the set time has elapsed.

 flashes and the time counts up. This enables you to see how long ago the minute minder time elapsed.

- Touch the  sensor to stop the process.

Changing the time set for the minute minder

- Touch the .

Change appears in the display. The current minute minder time is stopped.

- Confirm with *OK*.
- Modify the time using the arrow sensors and confirm with *OK*.

The minute minder time continues to count down.

Cancelling the minute minder

- Touch the .



Change appears in the display. The current minute minder is stopped.

- Select *Delete* using the arrow sensors and confirm with *OK*.

The minute minder is deleted.

Minute minder + cooking process

The minute minder can be used at the same time as a cooking process and counts down in the background.

- Touch  during the cooking programme.
- Select *Min. minder* using the arrow sensors and confirm with *OK*.
- Use the arrow sensors to set the required minute minder and confirm with *OK*.
- Touch .

The cooking duration and the minute minder time are visible counting down next to each other in the display.

The grill has 4 settings: Grill solo and 3 combination settings where the grill is used together with a specific microwave power level.

If the total grilling duration required is less than 15 minutes, the grill should be preheated for approx. 5 minutes.

Thin, flat cuts of fish and meat should usually be turned half way through grilling for even results. Larger, chunkier pieces should be turned several times.

Grilling times depend on the type and thickness of the food and on the user's preference for a rare, medium or well done result.

When grilling directly on the rack, a heat-resistant, microwave-safe container should be placed underneath the rack to catch any fat or juices.

 Risk of damage due to overheating.

The gourmet plate supplied is not suitable for catching fat. It could overheat when empty. This would damage the coating.

Use a heat-resistant, microwave-safe dish instead.

- Place the food in a suitable dish.
- Place the rack and a heat-resistant, microwave-safe dish or the container with the food to be cooked on the turntable.

 Danger of burning due to hot dishes.

The rack and container will become hot during cooking.

Wear oven gloves when removing the dishes from the oven.

The container and grill rack will be easier to clean if washed in soapy water immediately after grilling.

The area on the ceiling around the grill becomes discoloured over time. This is an unavoidable consequence of use, and does not impair the function of the appliance in any way.

Grilling without the Microwave function

Ideal for grilling thin cuts of meat, e.g. steak or sausages.

- Touch the  sensor.

The  sensor on the control panel will light up orange.

Duration and 00:00 min appear in the display.

- Use the arrow sensors to set the cooking duration you want and confirm your selection with *OK*.
- Touch the *start* sensor.

The cooking programme starts. A signal tone will sound when the cooking programme is finished.

Changing the grilling duration

The grilling duration can be changed during operation.

- Touch an arrow sensor.

The programme is interrupted.

- Change the time using the arrow sensors.
- Continue the programme by touching the *start* sensor.

Operation - Grilling

Selecting a start time or end time

The grilling time can be set to start at a certain time and will end after the set duration.

- Touch the  sensor.

The  sensor on the control panel will light up orange.

Duration and 00:00 min appear in the display.

- Use the arrow sensors to set the cooking duration you want and confirm your selection with *OK*.
- Then touch the  sensor.

Duration and the set duration for the grilling programme are shown in the display.

- Choose between the options *Start at* and *Finish at* using the arrow sensors.

With *Start at*, you specify when you want the grilling programme to start.
With *Finish at*, you specify when you want the grilling programme to end.

Alternatively, you can also select *Min. minder* here if you want to start a minute minder for a separate process in addition to the grilling programme.

- Confirm your selection with *OK*.

Start at or *Finish at* appears in the display, depending on which option you have selected.

The time is also highlighted.

- Use the arrow sensors to select the start or end time you want and confirm by touching *OK*.

Start at appears in the display and the  sensor lights up.

The grill programme will start at the selected time.





A signal tone will sound when the cooking programme is finished.





Combining grill and microwave

This function works well for baking and browning. The microwave cooks the food, and the grill browns it.

The grill can be combined with 3 different microwave power levels: 150, 300 and 450 watts.

It is not possible to switch between these 3 power levels during the cooking process without interrupting the programme.

The combinations  and  can be selected directly on the control panel; the combination  can be found under .

- Select the combination you want by touching the ,  or the  sensor if you want to select .

The corresponding sensor on the control panel will light up orange.

Duration and 00:00 min appear in the display.

- Use the arrow sensors to set the cooking duration you want and confirm your selection with *OK*.
- Touch the start sensor.

The cooking programme starts.

A signal tone will sound when the cooking programme is finished.

To change a cooking duration

The duration can be changed during operation.

- Touch an arrow sensor.

The programme is interrupted.

- Change the time using the arrow sensors.
- Continue the programme by touching the start sensor.

Selecting a start time or end time

The cooking time can be set to start at a certain time and will end after the preset duration.

- Select the combination function you want to use.

The corresponding sensor on the control panel will light up orange.

Duration and 00:00 min appear in the display.

- Use the arrow sensors to set the cooking duration you want and confirm your selection with *OK*.

- Then touch the  sensor.

Duration and the set duration for the grilling programme are shown in the display.

- Choose between the options *Start at* and *Finish at* using the arrow sensors.

With *Start at*, you specify when you want a programme to start.
With *Finish at*, you specify when you want a programme to end.

Alternatively, you can also select *Min. minder* at this point if you want to start a minute minder for a separate process in addition to the cooking programme.

- Confirm your selection with *OK*.

Start at or *Finish at* appears in the display, depending on which option you have selected.

The time is also highlighted.

- Use the arrow sensors to select the start or end time you want and confirm by touching *OK*.

Start at appears in the display and the sensor for the selected function lights up.

The cooking programme starts at the preset time.

A signal tone will sound when the cooking programme is finished.

Gourmet plate

Instructions for use

 Danger of burning due to hot dishes.

The gourmet plate gets extremely hot when in use.

Always use oven gloves when handling it to avoid burns. Place it on a suitable heat-resistant mat or pot rest.

Before using for the first time

Before using the gourmet plate for the first time, fill it with 400 ml water and add 2 to 3 tbsp. vinegar or lemon juice. Heat for 5 minutes at 450 W + Grill .

The gourmet plate has an easy-to-clean anti-stick coating so that food can be removed easily.

The coating is susceptible to cuts and scratches.

Metallic or sharp objects can damage the non-stick coating.

Therefore do not cut food up directly on the plate.

Use wooden or plastic utensils to mix or turn food.

Searing/browning food

 Risk of fire from overheating.

Oils and fats can ignite if allowed to overheat.

Never leave the appliance unattended when cooking with oil or fats.

- Only use very little oil when grilling with this dish. The anti-stick coating will prevent food from sticking to it, and this way you can reduce the amount of heated oil used.

- When using the gourmet plate, make sure that the food is ready to transfer to the gourmet plate as soon as the gourmet plate has heated up.

- Place the gourmet plate directly on the turntable.

Sparking can damage the gourmet plate and the oven interior.

Do not place the gourmet plate on the rack. Make sure there is a gap of approx. 2 cm between the gourmet plate and the interior walls of the microwave oven so that sparking cannot occur.

- Heat the plate up at 450 W + Grill  for up to max. 5 minutes.

 Risk of damage due to overheating.

Do not overheat the empty gourmet plate. This would damage the coating.

For this reason do not place the gourmet plate under the rack to catch the fat when grilling.

If using oil for grilling, you can either heat up the oil on the gourmet plate, or you can heat the oil separately and then add it to the plate.

Butter, however, should always be added after heating up the gourmet plate. It has a lower burning point than oil and would get too dark or burn if added too soon.







Always dry meat, poultry, fish and vegetables thoroughly before placing them on the gourmet plate.

Eggs can explode.

Do not use the gourmet plate to cook eggs or reheat cooked eggs.

Examples of use

Pre-heat the gourmet plate directly on the turntable for up to max. 5 minutes at 450 W + Grill .

- Fish fingers (frozen), 150 g + 1½ tbsp. oil , 3 – 4 minutes each side
- Hamburgers, 2 burgers + 1½ tbsp. oil , 3 – 4 minutes each side
- Croquette potatoes (frozen), 10 – 12 pieces + 1½ tbsp. oil , 6 – 8 minutes, turning halfway through
- Fillet steak, approx. 200 g , 5 minutes each side (according to taste)
- Pizza (frozen), 300 g , 7 – 9 minutes
- Pizza (fresh), without pre-heating , 15 minutes approx. (depending on topping)

Recipes

Preparation times given are the total time required for preparation and cooking. Standing time or time for marinating food is quoted in addition to preparation time.

Croque monsieur (serves 3)

Preparation time: 10 – 15 minutes

Ingredients

- 6 slices of white bread
- 30 g soft butter
- 75 g Emmental cheese, grated
- 3 slices of ham

Method

Butter the bread. Add the cheese to three of the bread slices in equal amounts and arrange a slice of ham on top of each. Place the remaining three slices of bread on top of the ham with the buttered side facing down. Pre-heat the gourmet plate using 450 W + Grill for approx. 5 minutes, then place the bread on it. Place on the turntable and cook using 450 W + Grill for approx. 3 minutes each side until golden. Other fillings could include drained tuna with finely sliced onion rings, or pineapple, cheese and ham.

Gourmet plate

Vegetable stir fry (serves 3)

Preparation time: 25 – 35 minutes

Ingredients

2 onions
1½ tbsp. oil
100 g oyster mushrooms or button mushrooms, cleaned
150 g sliced carrots
100 g broccoli florets
1 red capsicum or 100 g frozen sliced capsicums
1 tomato
Salt and pepper
30 g grated Parmesan cheese

Method

Slice the onions into fine rings. Halve, quarter and deseed the capsicum, and then cut into strips. Dice the tomato. Place the gourmet plate on the turntable and pre-heat it using 450 W + Grill for approx. 5 minutes. Add oil and onion rings. Place gourmet plate back on the turntable and cook using 450 W + Grill for approx. 2 minutes. Add the mushrooms, carrots, broccoli, sliced capsicum, diced tomato and seasoning. Mix well. Cook using 450 Watt + Grill for approx. 6 minutes. Turn and sprinkle with Parmesan cheese before serving.

Pork fillets (serves 2)

Preparation time: 15 – 20 minutes

Ingredients

1 pork tenderloin (approx. 400 g)
4 rashers of streaky bacon
Salt and pepper
10 g butter
200 g sliced button mushrooms
200 ml double cream
1½ tbsp. brandy

Method

Cut the pork tenderloin into four pieces. Season each piece with salt and pepper, and wrap in a rasher of streaky bacon. Secure with a cocktail stick if necessary. Place the gourmet plate on the turntable and pre-heat it using 450 W + Grill for approx. 5 minutes. Add the butter to the plate, and place the meat on top. Place on the turntable and cook using 450 W + Grill for approx. 3 minutes each side. Transfer the meat to a serving dish, cover and keep warm. Add the mushrooms, cream and brandy to the meat juices and heat at maximum power for approx. 4 minutes. Serve with the meat.

Pork fillet in a Roquefort sauce

Preparation time: 10 – 12 minutes

Method

Cut 1 pork tenderloin into four thick slices. Place on the pre-heated gourmet plate and cook using 450 W + Grill for approx. 4 minutes. Add 50 ml white wine, 125 ml double cream, 2 tbsp. roux (made from 1 tbsp. each flour and melted butter) and 150 g Roquefort cheese. Stir the sauce until smooth, and cook for a further 3 minutes.

Curried chicken (serves 3)

Preparation time: 25 – 35 minutes

Ingredients

600 g chicken or turkey breast fillets
1¹/₂ tbsp. oil
1¹/₂ tbsp. white wine
1¹/₂ tbsp. apple juice
3³/₄ tbsp. lemon juice
Salt and freshly ground black pepper
1 tsp. curry powder
1 pinch rosemary, ground
1 pinch ginger, ground
1 pinch cayenne pepper
1¹/₂ tsp. Tabasco
20 g butter

Method

Dice the meat into 2 x 2 cm pieces. Combine the rest of the ingredients apart from the butter, and pour over the meat. Mix well, and leave to stand for approx. 30 minutes. Place the gourmet plate on the turntable. Pre-heat it using 450 Watt + Grill for approx. 5 minutes. Add the butter to the pre-heated plate, then add the slightly drained meat. Place the gourmet plate on the turntable and cook using 450 W + Grill for approx. 4 minutes, turn and cook for a further 4 minutes on the same setting. Drain surplus liquid from the meat if necessary so that it browns well.

Fisherman's salmon (serves 2)

Preparation time: 5 – 10 minutes

Ingredients

2 salmon fillets (approx. 150 g each)
3³/₄ tbsp. lemon juice
Salt, white pepper

Method



Drizzle the salmon with the lemon juice, and leave to stand for approx. 10 minutes. Place the gourmet plate on the turntable and pre-heat using 450 W + Grill for approx. 5 minutes. Pat the fish dry with kitchen paper, and place on the gourmet plate, pressing it down slightly. Place on the turntable and cook using 450 W + Grill for approx. 1¹/₂ – 2 minutes each side. Serve with rice, hollandaise sauce or melted butter and a fresh green salad.



Operation - Automatic programmes

All of the Automatic programmes are weight dependent.

You can set the weight of food in grams (g), pounds (lb) or pounds/ounces (lb/oz) (see “Settings - Changing settings”).

There are four different categories of Automatic programmes:

- Cook 
- Defrosting
- Reheating
- Popcorn 

The cooking programmes and the popcorn programme can be selected using the  or  sensor controls. The Automatic programmes for the defrosting and reheating categories can be selected using the  sensor and then the arrow sensors.

Automatic programmes

- Select the required Automatic programme and confirm with *OK*.
- Enter the weight of the food and confirm with *OK*.
- Use the arrow sensors to choose between the options *Start now*, *Start at* and *Finish at*.
- Follow the instructions in the display, for example *Turn food* or *Stir food*.
- After cooking, leave the food to stand at room temperature for the suggested time (standing time) to allow the heat to be distributed evenly through the food.

Cooking

The grill is sometimes activated during some of the following cooking programmes.

 Damage caused by heat-sensitive plastics.

The material of a microwave cover must be able to withstand temperatures of up to 110 °C (see manufacturer information). At higher temperatures the plastic may distort and fuse with the food.

Only use microwave covers with Microwave Solo mode.

On no account may a cover be used if the grill is switched on, i.e. for programmes marked with *.

You can choose between 23 Automatic programmes. The standing time for each of these programmes is approx. 2 minutes.

- Bacon
- Potatoes
- Chicken pieces *
- Chicken in sauce
- Fish fillet
- Fish fillet in sauce
- Frozen chips *
- Soup
- Vegetables
- Frozen bakes *
- Pizza - thin base *
- Pizza - thick base *
- Frozen ready meals
- Frozen vegetables
- Fruit compote
- Bakes *
- Grilled chicken *
- Fish bake *
- Grilled fish *
- Rotisserie *
- Meat in sauce
- Rice
- Casserole
- * Grill activated at times

Defrosting

There are 13 programmes for defrosting different types of food. The standing time for each of these programmes is approx. 10 minutes.

- Bread
- Cakes
- Chicken legs
- Plated meals
- Fish fillet
- Fruit
- Meat pieces
- Minced meat
- Poultry
- Soup
- Sliced meat
- Vegetables
- Fish

Reheating

There are 8 Automatic programmes for reheating different types of food. The standing time for each of these programmes is approx. 2 minutes.

- Bakes
- Chicken in sauce
- Plated meals
- Fish fillet in sauce
- Soup
- Meat in sauce
- Casserole
- Vegetables

Popcorn

This Automatic programme is suitable for making microwave popcorn.

Microwave popcorn is commercially available in packets of various sizes. This programme is designed for a packet size of approx. 100 g. The duration for this programme can be altered within a certain range to suit different packet sizes (see “Settings - Changing settings”). The duration cannot, however, be altered whilst the programme is running.

The programme is not suitable for making popcorn from kernels.

Only use this Automatic programme for popcorn which is specifically labelled as microwave popcorn.

- Place the packet on the turntable according to the instructions on the packaging.

Make sure that the packet has enough room to expand. If it comes into contact with the wall of the oven interior and gets stuck there, a heat build-up may occur.

Ensure that the packet can inflate unhindered.

- Touch .

The programme will start after a short time. It will start immediately if the start sensor is touched.

You will soon hear the first kernels popping.

- Stop the programme before the end if the popping noises become infrequent. Follow the instructions on the packaging.

 Risk of burning on the hot packet. The packet is very hot. Take care when removing it.

Recipes - Automatic programmes

Below are some recipe suggestions for the Automatic programmes from the “Cook **Auto**” category. These can be adapted to suit your requirements.

If the weight guidelines are exceeded, the food will not cook sufficiently.
It is important to follow the weight guidelines given for each programme.

Vegetables

Preparation

Place the prepared vegetables in a container. Add 1 ½-2 tbsp. water, depending on freshness and moisture content, and a little salt or other seasoning. Enter the weight including that of the water, place the covered cooking container on the turntable and cook. About halfway through the cooking duration, a signal tone will sound to prompt you to turn or stir the food.

When cooking vegetables in a sauce, the weight entered must include the sauce. Do not exceed the maximum weight guidelines.

Carrots in a chervil cream sauce (serves 2)

Preparation time: 25–35 minutes

Ingredients

350 g carrots, cleaned
5 g butter
50 ml vegetable stock (instant)
75 ml crème fraîche
½ tbsp. white wine
Salt and pepper
1 pinch of sugar
½ tsp. mustard
1-2 tbsp. chervil, fresh, chopped or
1 tbsp. chervil, dried and ground
Approx. 1 tbsp. cornflour

Preparation

Peel carrots, then cut into batons or slices (approx. 3–4 mm thick). Combine the rest of the ingredients, and pour over the carrots in a bowl. Cover and cook. Stir when the signal tone sounds.

Setting: **Auto** Vegetables

Weight: 525 g

Shelf level: Turntable

Potatoes

This programme can be used to cook boiled, jacket and bouillon potatoes.

Preparation

Enter the weight for the potatoes and the cooking liquid.

For boiled potatoes, peel, wash and drain the potatoes and place them in a cooking container. Season with a little salt, cover and cook.

When boiling potatoes, add approx. ½ tbsp. water per potato. If cooking the potatoes in their skins, pierce the skins several times with a fork or skewer before cooking, then cover the container and cook.

Golden curried potatoes (serves 3)

Preparation time: 25–35 minutes

Ingredients

500 g peeled potatoes
1 onion, finely diced
10 g butter
1 – 2 tbsp. curry powder
250 ml vegetable stock (instant)
50 ml double cream
125 g peas (frozen)
Salt and pepper

Preparation

Coarsely dice the potatoes (approx. 3 x 3 cm) or use small potatoes. Mix together all the ingredients in a suitably large dish. Cover and cook. Stir when the signal tone sounds, then continue cooking.

Setting: Potatoes
Weight: 800 g
Shelf level: Turntable

Rice

Use this programme for cooking rice in the microwave.

Preparation

Enter the weight of the dry rice. Add boiling water to the dry rice in the ratio of 1 part rice to 2 parts water. Cover and cook the rice.

Vegetable gratin (serves 4)

Preparation time: approx. 40 minutes

Ingredients

400 g cauliflower or broccoli
400 g carrots

For the cheese sauce

20 g margarine
20 g flour
300 ml vegetable stock (instant)
200 ml milk
100 g diced Emmental cheese
50 g grated Gouda cheese
Salt, pepper, nutmeg
1 tbsp. chopped parsley

Preparation

Cut the cauliflower or broccoli into small florets, and thinly slice the carrots (approx. 3 mm thick). Place the vegetables in a baking dish (approx. 24 cm in diameter) and mix well. Melt the margarine in a pan on the stove, stir in the flour and then add the stock and milk whilst continuing to stir. Stir in the Emmental cheese, and simmer until the cheese has melted. Season well with nutmeg, salt and pepper and add the parsley. Pour the sauce over the vegetables, and sprinkle over the grated Gouda cheese. Bake in the oven uncovered.

Setting: Bakes
Weight: 1500 g
Shelf level: Turntable

Recipes - Automatic programmes

Potato cheese gratin (serves 4)

Preparation time: 45 minutes

Ingredients

For the gratin

600 g potatoes, floury

75 g Gouda, grated

For the topping

250 g cream

Salt, black pepper, nutmeg

Butter

For sprinkling

75 g Gouda, grated

For the tin

1 clove of garlic

Accessories

Microwave-safe ovenproof dish,

Ø 26 cm

Preparation

Rub the dish with the garlic clove.

To make the cream mixture, mix together the cream, salt, pepper and nutmeg.

Peel the potatoes and cut them into slices 3–4 mm thick. Mix the potatoes with the cheese and the cream mixture, and transfer to the ovenproof dish.

Sprinkle with gouda, then bake uncovered.

Setting: Auto Bakes

Weight: 1000 g

Shelf level: Turntable

Pork kebabs (makes 8 kebabs)

Preparation time: approx. 25–35 minutes + 1 hour standing time

Ingredients

1 fillet of pork (approx. 300 g)

1 red capsicum

2 onions

For the marinade

4 tbsp. oil

Salt, pepper, paprika and chilli powder

8 wooden skewers

Preparation

Cut the pork fillet into 16 cubes. Wash the capsicum and cut into bite-sized pieces. Cut the onions into eight pieces. Place the meat, capsicum and onion pieces alternately on the skewers. Mix together the ingredients for the marinade and brush the kebabs with the mixture. Allow to marinate for approx. one hour. Lay the kebabs on the lightly oiled grill rack, brush with butter and place in the oven together with a heat-resistant, microwave-safe dish. Turn halfway through grilling when the signal tone sounds.

Setting: Auto Rotisserie

Weight: approx. 100 g per kebab

Shelf level: Rack and dish on turntable

Chicken kebabs (makes 8 kebabs)

Preparation time: approx. 25–35 minutes + 1 hour standing time

Ingredients

4 chicken breasts each approx. 120 g
4 tinned pineapple rings
16 tinned apricot halves

For the marinade

2 tbsp. oil
2 tbsp. sesame oil
Salt and pepper
 $\frac{1}{2}$ tsp. paprika
 $\frac{1}{2}$ tsp. curry powder
A little chilli powder
Ground ginger or coriander, if desired
8 wooden skewers

Preparation

Cut each chicken breast into 4 pieces.
Cut the pineapple slices into quarters.
Drain the tinned apricot halves well. Mix all ingredients for the marinade thoroughly.

Arrange the chicken pieces, pineapple and apricots alternately on the wooden skewers, brush with the marinade and set aside for one hour. Lay the kebabs on the lightly oiled grill rack, brush with butter and place in the oven together with a heat-resistant, microwave-safe dish. Turn halfway through grilling when the signal tone sounds.

Setting:  Rotisserie

Weight: approx. 100 g per kebab

Shelf level: Rack and dish on turntable

Chicken thighs

Preparation

Brush the chicken thighs with butter or oil and season. Place on the grill rack in the oven together with a heat-resistant, microwave-safe dish. Halfway through cooking when a signal tone sounds, turn the chicken thighs over and continue to cook.

Setting:  Chicken pieces

Whole chicken

Preparation

Cut the chicken in half. Brush with melted butter or oil, and season. Then place the chicken halves on the grill rack in the oven with the cut side facing upwards together with a heat-resistant, microwave-safe dish. Halfway through cooking when the signal tone sounds, turn the chicken halves over and continue to cook.

Setting:  Grilled chicken

For grilling poultry

Preparation

For a good colour and flavour when grilling chicken, sprinkle with a mixture of paprika and curry powder. The spices will give the skin an appetising golden colour as well as enhance the flavour.

Recipes - Automatic programmes

Fish curry (serves 4)

Preparation time: 35–45 minutes

Ingredients

300 g pineapple chunks
1 red capsicum
1 small banana
500 g firm white fish
1 ½ tbsp. lemon juice
30 g butter
100 ml white wine
100 ml pineapple juice
Salt, sugar and chilli powder
2 tbsp. cornflour

Preparation

Dice the fish and place in a suitable container. Drizzle with lemon juice. Quarter the capsicum, remove the seeds and pith, and cut into narrow strips. Peel and slice the banana. Add to the fish along with the capsicum and pineapple pieces, and mix well. Add the butter. Mix together the wine, juice, seasoning and cornflour to make a smooth sauce and pour over the fish. Mix everything thoroughly, then cover and cook.

Setting:  Fish fillet in sauce

Weight: approx. 1200 g

Shelf level: Turntable

Crispy fish pie (serves 2)

Preparation time: 25–35 minutes

Ingredients

400 g filleted perch or other white fish, e.g. cod
1 ½ tbsp. lemon juice
Salt, white pepper
50 g butter
2 tsp. mustard
1 onion, finely diced
40 g grated Gouda cheese
20 g breadcrumbs
2 tbsp. fresh dill, chopped

Preparation

Drizzle the fish fillet with the lemon juice, and leave to stand for approx. 10 minutes. Grease a flat oven dish with a little butter. Pat the fish dry, season with salt and pepper and place in the dish. Mix the melted butter (450 W, 40–50 sec.) with the mustard, onions, Gouda cheese, breadcrumbs and dill, and brush onto the fish. Bake until golden.

Setting:  Fish bake

Weight: approx. 600 g

Shelf level: Turntable

Perch and tomato gratin (serves 4)

Preparation time: 35–45 minutes

Ingredients

500 g filleted rosefish or other white fish, e.g. cod
1 tbsp. lemon juice
500 g tomatoes
Herb seasoning salt
2 tsp. ground oregano
150 g grated Gouda cheese

Preparation

Cut the fish into pieces, drizzle with lemon juice and leave to stand for approx. 10 minutes. Dice the tomatoes, and place in a baking dish with the fish and half of the cheese. Season generously with herb salt and oregano, and mix well. Sprinkle with the rest of the cheese and bake uncovered.

Setting:  Fish bake

Weight: approx. 1150 g

Shelf level: Turntable

Grilled trout (serves 4)

Preparation time: 25–30 minutes

Ingredients

4 trout, 250 g each
4–8 tbsp. chopped parsley
Salt, pepper, lemon juice
Flakes of butter

Preparation

Clean the trout, season inside and out and stuff with herbs. Lay the trout on the lightly oiled grill rack, brush with butter and place in the oven together with a heat-resistant, microwave-safe dish.

Setting:  Grilled fish

Weight: approx. 1000 g

Shelf level: Rack and dish on turntable

Bacon

Use this programme to make crispy bacon in the microwave.

Preparation

Place a sheet of kitchen paper on a microwave-safe plate.
Place the bacon on top of the paper and cover it with another sheet of kitchen paper.
Select the Bacon programme, enter the number of rashers and start the programme.

Chicken breast in mustard sauce (serves 4)

Preparation time: 30 minutes

Ingredients

250 ml crème fraîche
1 clove of garlic, crushed
4 tbsp. sweet mustard
1½ tsp salt
½ tsp sage
4 chicken breast fillets (200 g each), ready to cook

Accessories

Microwave-safe ovenproof dish

Preparation

To make the sauce, mix together the crème fraîche, garlic, mustard, salt and sage.

Place the chicken breast fillets in the ovenproof dish and spread the sauce over the top. Cover and start the programme.

Turn the chicken breast fillets over and baste them with the sauce when the instruction Turn appears in the display. Cover and continue to cook.

Setting:  Chicken in sauce

Weight: 1100 g

Shelf level: Turntable

Useful tip

As an alternative, try using coarse grain mustard instead.

Recipes - Automatic programmes

Minestrone (serves 4)

Preparation time: 40 minutes

Ingredients

50 g bacon
1 onion
150 g celery
2 tomatoes
150 g carrots
100 g green beans, frozen
100 g peas, frozen
50 g pasta (small shells)
1 tbsp. mixed Italian herbs, frozen
100 ml vegetable stock
100 g hard cheese (Parmesan), whole piece

Accessories

Glass dish with lid, microwave-safe

Preparation

Dice the bacon and onion. Dice the celery and tomatoes. Cut the carrots into slices. Put all of these into the glass dish.

Add the beans, peas, pasta and herbs along with the stock and stir. Cover and start the programme.

Stir the soup occasionally and cover and continue to cook.

Grate the parmesan and sprinkle it over the soup.

Setting:  Soup
Weight: 1000 g
Shelf level: Turntable

Useful tip

Instead of pasta, you could also use 150 g diced potatoes.

White cabbage stew (serves 4)

Preparation time: 45 minutes

Ingredients

200 g beef mince
 $\frac{1}{2}$ tsp salt
 $\frac{1}{2}$ tsp sweet paprika
Pepper
1 onion
250 g potatoes
100 g leeks
250 g white cabbage
250 g beetroot
250 ml beef stock
 $1\frac{1}{2}$ tsp salt
1 tbsp. red wine vinegar
150 g crème fraîche
1 tbsp. chopped parsley

Accessories

Microwave-safe bowl

Preparation

Knead together the mince, paprika, salt and pepper. Form into small minced meat balls and place in the bowl.

Dice the onion and potatoes. Cut the leek into rings. Shred the white cabbage. Grate the beetroot.

Layer the vegetables on top of the meatballs. Add the beef stock and salt. Cover and cook according to the programme.

Stir in the crème fraîche and parsley. Season with the red wine vinegar to taste.

Setting:  Casserole
Weight: 1600 g
Shelf level: Turntable

Meatballs (serves 4)

Preparation time: 30 minutes

For the meatballs

40 g breadcrumbs
110 ml water
1 onion, finely diced
250 g pork mince
250 g beef mince
1 medium egg
1 tsp. salt
Pepper

For the sauce

40 g softened butter
40 g plain white flour
500 ml meat stock, cold
2 tbsp. cream
1 tbsp. capers
1 tsp lemon juice

Accessories

Microwave-safe ovenproof dish

Preparation

Mix together the water and breadcrumbs and leave to soak.

Add the mince and onions to the breadcrumbs. Add the egg, salt and pepper, and knead into a meat dough. Shape into 8 meatballs and place in an ovenproof dish.

Mix together the butter and flour; divide this mixture into small portions and place next to the meatballs. Add the meat stock. Cover and cook according to the programme.

When the signal tone sounds, carefully stir the sauce until smooth. Season with the cream, capers and lemon and continue to cook.

Setting:  Meat in sauce

Weight: 1400 g

Shelf level: Turntable

Frozen pizza

You can use the Pizza - thin base and Pizza - thick base programmes to cook frozen pizza.

The Pizza - thin base programme is suitable for thin, pre-baked pizzas; the Pizza - thick base programme is suitable for thicker pizzas with dough that still needs to rise in the oven.

Select the right programme depending on the pizza.

Fish fillet

Season the ready-to-cook fish fillet according to taste, place in a microwave-safe, ovenproof dish, cover with heat-resistant film or with a microwave-safe cover, enter the weight and cook.

Red berry compote (serves 4)

Preparation time: 15–20 minutes

Ingredients

400 g mixed berries (e.g. strawberries, raspberries), fresh or frozen
50 ml strawberry syrup
1–2 tbsp. cornflour
20 ml crème de cassis

Preparation

Add 100 ml water and the strawberry syrup to the berries in a bowl.

Mix together the cornflour with 1 tbsp. water and the crème de cassis. Add to the berries and cook according to the programme.

Setting:  Fruit compote

Weight: 500 g

Shelf level: Turntable

Useful tip

Serve with vanilla ice cream or custard.

Reheating

Select the following microwave power levels to reheat food:

Drinks	900 W
Food	600 W
Food for babies and children	450 W

 Risk of burning due to hot food. Food for babies and children must not be too hot. Reheat it for only 1/2 to 1 minute at 450 W.

Tips on reheating

Always use a lid or cover for reheating food, except when a crispy finish is required, e.g. crumbed poultry/meat.

 Risk of explosion due to pressure build-up. Pressure can build up when reheating food or drinks in sealed containers, jars or bottles, which can cause them to explode. Sealed glass containers, such as jars of baby food, must be opened before they are placed in the microwave. Do not attempt to heat them up unopened. With baby bottles, the screw top and teat must be taken off.

 Risk of injury from boiling liquids. When heating liquids, milk, sauces etc. using microwave power, the boiling point of the liquid may be reached without the production of the typical bubbles. Liquids do not boil evenly throughout. This so-called 'boiling delay' can cause a sudden build-up of bubbles when the container is removed from the oven or shaken, which can lead to the liquid boiling over suddenly and explosively. The formation of bubbles can be so strong that the pressure forces the oven door open. Flash boiling can be avoided by stirring liquids before heating them. After heating, wait at least 20 seconds before removing the container from the oven. In addition, a glass rod or similar item, if available, can be placed in the container during heating.

Eggs can explode. Never reheat hard boiled eggs in the microwave, even without the shell.

Food taken straight from the refrigerator takes longer to reheat than food which has been kept at room temperature. The reheating time required depends on the nature of the food, its initial temperature and the amount to be cooked.

Always ensure that food is sufficiently cooked or reheated.

If in any doubt that a sufficiently high temperature has been reached, continue reheating for a little longer.

Stir or turn larger amounts of food from time to time during reheating. Stir the food from the outside towards the middle, as food heats more quickly around the outside.

After reheating

Be careful when removing the dish from the oven. It may be hot.

Although heat is not normally produced in the container itself by the microwaves (apart from stoneware), heat transfer from the food to the container may be considerable, making the container itself hot.

Allow food to stand for a few minutes at room temperature at the end of cooking. This enables the heat to spread evenly through the food.

 Risk of burning due to hot food.

The food can be very hot after reheating.

After reheating food, especially food for babies and small children, stir the food or shake the container and check that the temperature does not pose any danger.

Cooking

Place the food in a microwave-proof dish and cover it.

When cooking, it is a good idea to select a power level of 900 W to start with, and when the food is hot reduce the power level to 450 W for more gentle continued cooking.

For dishes such as **rice pudding** or **semolina pudding**, first select a power level of 900 W, and then reduce it to 150 W for simmering.

Tips on cooking

Vegetable cooking durations depend on the texture of the vegetables. Fresh vegetables contain more water than vegetables which have been stored, and usually cook more quickly. Add a little water to vegetables which have been kept stored.

Food taken straight from the refrigerator takes longer to cook than food which has been kept at room temperature.

Stir or turn food from time to time during cooking. This helps it cook more evenly.

 Health risk due to cooking time being too short.

It is very important to make sure that food which goes off easily, such as fish, is cooked for a sufficient time. When cooking these types of food, ensure that the stated cooking durations are observed.

Food with a thick skin or peel, such as tomatoes, sausages, jacket potatoes and aubergines, should be pierced or the skin scored in several places before cooking to allow steam to escape and to prevent the food from bursting.

 Risk of injury from eggs with shells.

Eggs heated in their shells can burst, even after they have been taken out of the oven.

Eggs can only be cooked in their shells in the microwave oven in a specially designed egg-boiling device available from specialist shops.

 Risk of burning from eggs without shells.

If you cook eggs without their shells using microwave power, the yolks could explode due to the resulting pressure.

Eggs can be cooked without their shells in the microwave oven only if the yolk membrane has been punctured several times first.

After cooking

Be careful when removing the dish from the oven. It may be hot.

Although heat is not normally produced in the container itself by the microwaves (apart from stoneware), heat transfer from the food to the container may be considerable, making the container itself hot.

Allow food to stand for a few minutes at room temperature at the end of cooking. This enables the heat to spread evenly through the food.

Defrosting

 Health risk due to refreezing.

Thawed or defrosted food loses nutritional value through refreezing and can go off.

Do not refreeze food once it has thawed. Use it as quickly as possible. Defrosted food may only be refrozen after it has been cooked.

Select the following microwave power settings to defrost food:

- 80 W
for defrosting very delicate food, e.g. cream, butter, gâteau and cheese.
- 150 W
for defrosting other types of food.

Remove the food from its packaging and place in a microwave-proof container. Defrost uncovered. Turn, stir or separate the food about halfway through the defrosting time.

To defrost meat, unpack the frozen meat and place it on an upturned plate in a glass or porcelain container so that the meat juice can run off and be collected. Turn halfway through defrosting.

 Health risk due to risk of salmonella.

It is particularly important to observe food hygiene rules when defrosting poultry.

Do not use the liquid produced during defrosting.

Meat and poultry need to be fully defrosted before cooking.

Fish, on the other hand, can be partially defrosted before cooking. Defrost so that the surface is sufficiently soft to take herbs and seasoning.

Defrosting and cooking

Deep-frozen food can be defrosted and immediately heated or cooked.

First select 900 W followed by 450 W.

Remove the food from its packaging and place in a covered microwave-proof dish for defrosting and reheating or cooking. Exception: Minced meat should be left uncovered while cooking.

Food with a high water content such as soup, stew and vegetables should be stirred several times during the process. Carefully separate and turn slices of meat halfway through the programme. Turn pieces of fish at the halfway stage.

After defrosting and reheating or cooking allow the food to stand at room temperature for a few minutes to enable the heat to spread evenly through the food.

You can preserve small portions of fruit, vegetables and meat in microwave-safe jars that are available from specialist retailers. Prepare the jars in the usual way.

Fill the jars no more than up to 2 cm below the rim.

Seal the microwave-safe preserving jars with clear adhesive tape or clips suitable for microwave use.

Never use metal clips, jars with screw-on lids or cans in order to prevent sparking.

For best results do not use more than four 1/2-litre jars at a time when bottling.

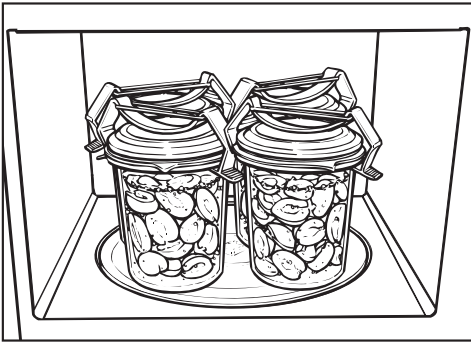

- Place the jars on the turntable.
- Set to 900 W and bring the jar contents to the boil.

The time required depends on:

- the initial temperature of the contents.
- the number of jars.

The amount of time required for the contents in all jars to start bubbling evenly is as follows:

1 jar	approx. 3 minutes
2 jars	approx. 6 minutes
3 jars	approx. 9 minutes
4 jars	approx. 12 minutes

This is sufficient time for bottling fruit and cucumbers.

For vegetables, reduce the power to 450 W once the produce starts boiling. Cook

- carrots for approx. 15 minutes
- peas for approx. 25 minutes.

After bottling

Remove jars from the oven, cover with a towel and leave to stand in a draught-free location for approx. 24 hours.

Remove the clips or the adhesive tape and make sure that all jars are sealed properly.

Examples of use

Food	Quantity	MW power level (Watt)	Duration (in minutes)	Notes
Melting butter/margarine	100 g	450	1:00–1:10	Do not cover
Melting chocolate	100 g	450	3:00–3:30	Do not cover, stir halfway through melting
Dissolving gelatine	1 packet + 3 tbsp. water	450	0:10–0:30	Do not cover, stir halfway through dissolving
Preparing flan topping/jelly glaze	1 packet + 250 ml liquid	450	4–5	Do not cover, stir halfway through heating
Yeast dough	Starter dough made with 100 g flour	80	3–5	Cover and leave to prove
Chocolate marshmallows	20 g	600	0:10–0:20	Place on a plate, do not cover
Steeping oil for salad dressing	125 ml	150	1–2	Heat uncovered on gentle heat
Tempering citrus fruits	150 g	150	1–2	Place on a plate, do not cover
Softening ice cream	500 g	150	1–3	Place open container in the appliance
Skinning tomatoes	3 pieces	450	6–7	Cut a cross into the top of each tomato, cover, and heat in a little water. The skins will slip off easily. Take care, as the tomatoes can get very hot.
Making strawberry jam	300 g strawberries, 300 g jam sugar	900	7–9	Mix the fruit and sugar in a deep container, cover and cook.
Defrosting and baking part-baked bread rolls	2 rolls	150 + Grill Grill	1–2 4–6	Place uncovered on the rack, turning halfway through.

The information given in this chart is intended only as a guide.

Disconnect the microwave oven from the power supply before cleaning.

Under no circumstances should a steam cleaner be used to clean the microwave oven. The steam could reach live electrical components and cause a short circuit.

Oven interior and inside of the door

 Risk of burning due to hot oven compartment.

The oven compartment may be too hot to clean immediately after use. Clean the oven interior once it has cooled down.

 Fire hazard due to excessive soiling.

Excessive soiling could damage the appliance in certain circumstances and could even be dangerous due to the fire risk.

Do not wait too long to clean the appliance as this will make cleaning unnecessarily difficult and in extreme cases, impossible.

The microwave oven interior and door interior can be cleaned using a damp cloth with a little washing-up liquid or a mild detergent and water. Wipe dry with a soft cloth.

For more heavy soiling, heat a glass of water for 2 to 3 minutes until the water begins to boil. The steam will collect on the walls and soften the soiling. The oven interior can now be wiped clean using a little washing-up liquid if necessary.

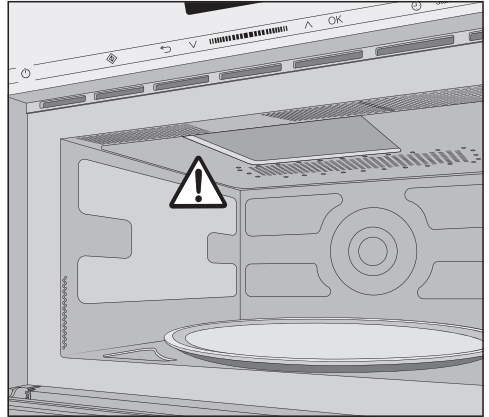

Do not remove the cover from the microwave outlet inside the oven.

Do not let water or any object find its way into or block the air vents of the appliance.

Do not use too much water on the cloth or sponge, otherwise water may get into openings.

Do not use scouring agents. These will scratch.

To neutralise odours in the microwave oven, put a cup of water with some lemon juice in the appliance and simmer for a few minutes.

Cleaning and care

 Danger to health due to a defective device.

If any damage to the door or the door seals is noticed, the appliance must not be used until the fault has been repaired by a Miele authorised service technician. Operating a damaged appliance can result in microwave leakage and present a hazard to the user.

The door should be kept clean at all times and checked at regular intervals for any signs of damage. Do not use the appliance if

- the appliance door is warped.
- the door hinges are loose.
- holes or cracks are visible in the casing, the door or the oven interior walls.

To clean the interior:



- Remove the turntable, and wash in the dishwasher or by hand.

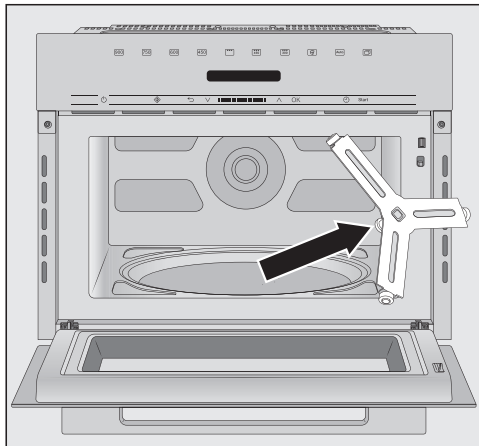

- Always keep the roller ring underneath it and the oven floor clean. Otherwise the turntable will not turn smoothly.
- Clean the area between the turntable and the roller ring.

Do not turn the turntable and/or carrier manually, as this could damage the drive motor.

Appliance front

Do not let water or any small particles penetrate the vents in the appliance.

Soiling that is left too long might become impossible to remove and could cause external surfaces to alter or discolour.

Remove any soiling on the front of the appliance straight away.

Clean the front with a soft sponge and a solution of warm water and a little washing-up liquid. Wipe dry using a soft cloth.

A clean, damp microfibre cloth without cleaning agent can also be used.

All surfaces of this appliance are susceptible to scratching. Scratches on glass surfaces could cause a breakage in certain circumstances. Contact with unsuitable cleaning agents can alter or discolour all surfaces.

Please observe the following cleaning instructions.

To avoid damaging the surfaces of the appliance, do not use:

- cleaning agents containing soda, ammonia, acids or chlorides
- cleaning agents containing descaling agents
- abrasive cleaning agents, e.g. powder cleaners and cream cleaners
- solvent-based cleaning agents
- stainless steel cleaning agents
- dishwasher cleaner
- oven sprays
- glass cleaning agents

- hard, abrasive sponges and brushes, e.g. pot scourers
- dirt erasers
- sharp metal scrapers.

Accessories supplied

Rack

Wash and dry the rack after each use. It is dishwasher-proof. Remove stubborn soiling with a stainless steel cleaner.

Gourmet plate

Clean the gourmet plate with hot water and a cloth with a little washing-up liquid to remove any grease.

Do not use steel wool, abrasive sponges, or aggressive cleaning agents.

Do not clean the gourmet plate in the dishwasher.

If the gourmet plate has been used to cook food with a strong aroma, you can neutralise any odours by adding some water and lemon juice to the gourmet plate and heating it in the microwave oven at maximum power for 2-3 minutes. Rinse the gourmet plate afterwards with clean water.

Problem solving guide

Many malfunctions and minor faults that can occur in daily operation can be corrected without contacting Miele. This will save you time and money because you will not need a service call.

You can find information on how to remedy faults yourself at www.miele.com.au/service or www.miele.co.nz/service and on the Miele website. Please note, however, that a call-out charge will be applied to unnecessary service visits where the problem could have been rectified as described in these operating instructions.

Problem	Possible cause and remedy
A programme will not start.	Check whether <ul style="list-style-type: none"> ■ the appliance door is closed properly. ■ the system lock has been activated (see “System lock”). ■ Food in oven? has appeared in the display. The door has not been opened recently (in the last 20 minutes) (see “Operation - Food in oven?”). ■ the appliance is plugged into the mains supply and switched on at the socket. ■ the mains circuit breaker has tripped. If it has, there could be a fault with the appliance, the household electricity supply or another appliance (disconnect the appliance from the electricity supply and contact a qualified electrician or Miele, see “After sales service”).
A noise can be heard after a cooking process.	This is not a fault. The cooling fan will continue to run for a while after a cooking programme to prevent any humidity building up in the oven, on the control panel or the oven housing unit. It will switch off automatically.
The display is dark.	The time of day display has been switched off. <ul style="list-style-type: none"> ■ Switch on the appliance using the On/Off  sensor .
The turntable does not turn smoothly.	The area underneath the turntable could be dirty. <ul style="list-style-type: none"> ■ Check whether the oven floor underneath the turntable is clean. ■ Check whether the surfaces between the turntable and the roller ring are clean. ■ Clean the area underneath the turntable.
Food is not adequately defrosted, heated or cooked at the end of the selected cooking duration.	The duration or power level were insufficient to cook the food. <ul style="list-style-type: none"> ■ Check whether the correct power level was selected for the duration set. The lower the power level, the longer the duration required. ■ Check whether the programme has been interrupted and not restarted.

Problem solving guide

Problem	Possible cause and remedy
The microwave operation works but not the lighting.	<p>The lamp needs to be replaced. You can operate the appliance as normal, but without the lighting.</p> <ul style="list-style-type: none"> ■ Contact Miele if you need to replace the lamp.
Strange noises are heard when the microwave oven is being used.	<p>The food is covered with aluminium foil.</p> <ul style="list-style-type: none"> ■ Remove the aluminium foil.
	<p>Sparks are being created by the use of crockery with a metallic finish.</p> <ul style="list-style-type: none"> ■ Please observe the information on suitable containers for microwave use.
The time of day in the display is not accurate.	<p>The time of day must be reset following an interruption to the power supply.</p> <ul style="list-style-type: none"> ■ Set the correct time of day.
Food cools down too quickly.	<p>In a microwave oven, food begins to cook from the outside first, the inside of the food relying on the slower conduction of heat.</p> <p>If food is cooked at a high power level, it is possible that the heat may not have reached the centre of the food, so it is hot on the outside but cold in the centre. During standing time heat is transferred to the centre of the food.</p> <ul style="list-style-type: none"> ■ This may leave the food warm in the middle but cool on the outside. When reheating food with different densities, such as plated meals, it is therefore recommended to select a lower power level and lengthen the duration.
The microwave oven switches itself off during a cooking, reheating or defrosting programme.	<p>There may be insufficient air circulation.</p> <ul style="list-style-type: none"> ■ Check whether the air inlet or outlet is blocked. Remove any obstruction.
	<p>The appliance switches off automatically in cases of overheating.</p> <ul style="list-style-type: none"> ■ Cooking can be continued after a cooling-down period.
	<p>If the appliance keeps switching itself off</p> <ul style="list-style-type: none"> ■ Contact Miele.

Service

You can find information on how to remedy faults yourself at www.miele.com.au/support/customer-assistance or www.miele.co.nz/support/customer-assistance and about Miele spare parts at www.miele.com.au/service or www.miele.co.nz/service.

Contact in case of fault

In the event of any faults which you cannot remedy yourself, please contact Miele.

You can book a Miele customer service call-out online at www.miele.com.au/service or www.miele.co.nz/service.
Contact information for Miele can be found at the end of this booklet.

Please quote the model and serial number of your appliance when contacting Miele. This information can be found on the data plate.

Warranty

The manufacturer's warranty for this appliance is 2 years.

For further information, please refer to your warranty booklet.

Miele Australia Pty. Ltd.

ACN 005 635 398

ABN 96 005 635 398

Level 4, 141 Camberwell Road
Hawthorn East, VIC 3123

1300 464 353 (1300 4 MIELE)

info@miele.com.au

www.miele.com.au

Miele New Zealand Limited

IRD 98 463 631

8 College Hill
Freemans Bay, Auckland 1011

0800 464 353 (0800 4 MIELE)

customercare@miele.co.nz

www.miele.co.nz

Miele Global Headquarters

Germany

Miele & Cie. KG

Carl-Miele-Straße 29

33332 Gütersloh

Federal Republic of Germany

M 7244 TC

en-AU, NZ

M.-Nr. 11 195 170 / 11