

















## Operating and installation instructions Refrigerator



It is **essential** to read these operating and installation instructions before installing and using the appliance. This prevents both personal injury and damage to the appliance.

# Contents

---

<b>Warning and Safety instructions ..</b>	<b>4</b>	<b>Operation.....</b>	<b>32</b>
<b>Sustainability and environmental protection .....</b>	<b>13</b>	The correct temperature .....	32
How to save energy .....	14	Temperature display.....	32
<b>Installation.....</b>	<b>15</b>	Setting the temperature .....	32
Installation site .....	15	Using SuperCool and DynaCool .....	33
Ventilation requirements .....	16	Storing food in the refrigerator section .....	34
Installing several refrigeration appliances next to one another .....	16	Different storage zones .....	34
Side-by-side installation .....	17	Should food be stored loose or in packaging? .....	35
Door hinging change .....	17	Storing food in the DailyFresh drawer.....	35
Ordering printed installation instructions.....	17	<b>Selecting further settings .....</b>	<b>37</b>
Installing the refrigeration appliance .....	17	Explanation of the different settings .....	37
Aligning the appliance.....	18	Party mode  .....	37
Integrating the refrigeration appliance in a run of kitchen units ..	19	Holiday mode  .....	37
Appliance dimensions.....	21	Switching the lock function  /  on .....	37
Electrical connection .....	24	Sabbath mode  .....	38
<b>Guide to the appliance.....</b>	<b>25</b>	Information on Sabbath mode  .....	39
Appliance overview .....	25	Changing the time before the door alarm  is triggered .....	39
Control panel with display.....	27	Changing the volume of the alarms and buzzers  /  .....	39
Settings mode  .....	27	Adjusting the display brightness  .....	39
Adjusting the interior fittings .....	29	Switching off Demo mode  .....	40
Moving the door/bottle shelf .....	29	Resetting the settings to their factory default settings  .....	40
Moving the adjustable shelves ..	29	Information  .....	40
Space for a baking tray.....	29	Charcoal filter change indicator  .....	40
Moving the Active AirClean filters.....	29	Cleaning mode  .....	40
Accessories supplied .....	30	<b>Cleaning and care .....</b>	<b>41</b>
Optional accessories .....	30	Defrosting.....	41
<b>Switching on and off.....</b>	<b>31</b>	Cleaning agents.....	41
Before using for the first time .....	31	Preparing the refrigeration appliance for cleaning.....	41
Connecting the appliance.....	31	Cleaning the interior of the appliance .....	41
Switching on the appliance.....	31	Cleaning accessories by hand or in the dishwasher .....	42
Switching off the appliance .....	31		
Switching off for longer periods of time .....	31		

Removing and dismantling accessories for cleaning .....	42
Cleaning the front of the appliance and the side panels .....	44
Cleaning the door seal .....	45
Cleaning the ventilation openings... After cleaning .....	45
<b>Problem solving guide</b> .....	<b>46</b>
Interior lighting.....	51
Noises .....	51
<b>Service</b> .....	<b>54</b>
Contact in case of fault.....	54
Warranty .....	54

## Warning and Safety instructions

---

This refrigeration appliance complies with current local and national safety requirements. However, inappropriate use can lead to personal injury and damage to property.

Please read the operating and installation instructions carefully before using the refrigeration appliance for the first time. They contain important information on installation, safety, use and maintenance. This will prevent both personal injury and damage to the refrigeration appliance.

In accordance with standard IEC 60335-1, Miele expressly and strongly advises that you read and follow all information provided concerning the installation of the refrigeration appliance, as well as safety notes and warnings.

Miele cannot be held liable for injury or damage caused by non-compliance with these instructions.

Keep these operating and installation instructions in a safe place and pass them on to any future owner.

### Correct application

► This appliance is designed for domestic use and for use in similar environments by guests in hotel or motel rooms, bed & breakfasts and other typical living quarters. This does not include common/shared facilities or commercial facilities within hotels, motels or bed & breakfasts.

► The refrigeration appliance is intended exclusively for domestic use for cooling and storing food and drink. The refrigeration appliance is not suitable for freezing food. Any other usage is not permitted.

► This appliance is not suitable for storing and keeping cool medicines, blood plasma, laboratory preparations or similar substances or products. Incorrect use of the appliance for such purposes may cause deterioration of the items stored. The appliance is also not suitable for use in areas where there is a risk of explosion.

Miele cannot be held liable for damage resulting from incorrect or improper use or operation of the appliance.

# Warning and Safety instructions

---

▶ This appliance is not intended for use by persons (including children) with reduced physical, sensory or mental capabilities or lack of experience and knowledge, unless they have been given supervision and instruction concerning its use by a person responsible for their safety.

They may only use the appliance unsupervised if its operation has been clearly explained to them and they are able to use it safely and are able to understand and recognise the possible dangers caused by incorrect operation.

## Safety with children

▶ Younger children must be kept away from the refrigeration appliance unless they are constantly supervised.

▶ Older children may only use the appliance when its operation has been clearly explained to them and they are able to use it safely, recognising the dangers of misuse.

▶ Cleaning work may only be carried out by older children under the supervision of an adult.

▶ Please supervise children in the vicinity of the appliance and do not let them play with it.

▶ Danger of suffocation. Whilst playing, children may become entangled in packaging material (such as plastic wrapping) or pull the packaging material over their head, presenting the risk of suffocation. Keep packaging material away from children.

## Technical safety

▶ The refrigerant circuit has been checked for leaks. The refrigeration appliance complies with all current local and national safety requirements.



If the cooling circuit is damaged, refrigerant and oil can escape and ignite.

▶ Warning: fire hazard/flammable materials. This symbol is on the compressor and indicates flammable materials. Do not remove this sticker.

## Warning and Safety instructions

---

The refrigerant inside the appliance (details on the data plate) is environmentally friendly but flammable.

The use of this refrigerant does, however, sometimes lead to a slight increase in the noise level of the appliance. In addition to the noise of the compressor, you might be able to hear the refrigerant flowing around the cooling circuit. Unfortunately, these effects cannot be avoided, but they do not affect the performance of the refrigeration appliance.

When transporting and installing the refrigeration appliance, ensure that no parts of the cooling circuit are damaged. Splashes of refrigerant can damage the eyes and leaking refrigerant can ignite. In the event of any damage:

- Avoid naked flames or anything which creates a spark.
- Disconnect the refrigeration appliance from the mains electricity supply.
- Ventilate the room in which the refrigeration appliance is located for several minutes.
- Call Customer Service.

► The more refrigerant there is in a refrigeration appliance, the larger the room should be in which it is installed. In the event of a leakage, if the appliance is in a small room, there is the danger of a combustible gas/air mixture building up. For every 8 g of refrigerant, at least 1 m<sup>3</sup> of room space is required. The amount of refrigerant in the refrigeration appliance is stated on the data plate inside the appliance.

► If the ventilation openings are covered or blocked, a combustible gas/air mixture can form if the cooling circuit is damaged. It is essential to observe the required ventilation openings. The ventilation openings must not be covered or blocked in any way.

► To avoid the risk of damage to the appliance, make sure that the connection data (fuse rating, frequency and voltage) on the data plate corresponds to the household supply. Check that this is the case before connecting the appliance.

Consult a qualified electrician if in any doubt.

► The electrical safety of this appliance can only be guaranteed when correctly earthed. It is essential that this standard safety requirement is met. If in any doubt please have the electrical installation tested by a qualified electrician.

## Warning and Safety instructions

---

- ▶ Temporary or permanent operation with a self-sufficient or non-mains synchronous energy supply system (e.g. isolated networks, back-up systems) is possible. A requirement for the operation is that the energy supply system complies with all current local and national requirements that apply to stand-alone, solar and/or battery systems. The protective measures provided in the installation and in this Miele product must also be assured in their function and operation in isolated operation or in non-mains synchronous operation, or replaced with equivalent measures in the installation.
- ▶ The socket must not be concealed behind the appliance and must be easily accessible so that the appliance can be quickly disconnected from the electricity supply in case of an emergency.
- ▶ If the power supply cord is damaged, disconnect the refrigeration appliance from the mains power supply immediately. Call Customer Service.
- ▶ If the power supply cord is damaged, it must only be replaced with a specific power supply cord of the same type (available in the Miele online shop or from Miele Customer Service). For safety reasons, replacement may only be carried out by a suitably qualified specialist or Miele Customer Service.
- ▶ Do not connect the appliance to the mains electricity supply by a multi-socket unit or an extension lead. These do not guarantee the required safety of the appliance (e.g. danger of overheating).
- ▶ If moisture gets into electrical components or into the mains connection cable, it could cause a short circuit. Therefore, do not operate this refrigeration appliance in areas which are exposed to moisture (e.g. in a garage or laundry).
- ▶ This appliance must not be installed and operated in mobile installations (e.g. on a ship).
- ▶ Do not use a damaged appliance. It could be dangerous. Check the appliance for visible signs of damage.
- ▶ This refrigeration appliance is not intended for use as a built-in appliance.
- ▶ During installation, maintenance and repair work, the appliance must be disconnected from the mains electricity supply. It is only completely isolated from the electricity supply when:

## Warning and Safety instructions

---

- the mains circuit breaker has been switched off, or
- the screw-out fuse is removed (in countries where this is applicable), or
- it is switched off at the wall socket and the plug is withdrawn from the socket. Do not pull the mains connection cable but the mains plug to disconnect your appliance from the mains electricity supply.

▶ Installation, repairs, and other work by unqualified persons could be extremely dangerous. The manufacturer cannot accept liability for unauthorised work.

Installation, maintenance and repairs must only be carried out by a qualified specialist or Miele Customer Service.

▶ The manufacturer's warranty will be invalidated if the refrigeration appliance is not repaired by a qualified specialist or Miele Customer Service.

▶ We recommend replacing faulty components with original Miele parts. If original Miele parts are installed correctly, Miele ensures full compliance with safety requirements and the warranty remains valid.

▶ This refrigeration appliance is supplied with a special lamp to cope with particular conditions (e.g. temperature, moisture, chemical resistance, abrasion resistance and vibration). This lamp must only be used for the purpose for which it is intended. The lamp is not suitable for room lighting. Replacement lamps may only be installed by a qualified specialist or Miele Customer Service. This refrigeration appliance contains several light sources with at least energy efficiency class F.

▶ In areas which may be subject to infestation by cockroaches or other vermin, pay particular attention to keeping the appliance and its surroundings clean at all times. Any damage caused by cockroaches or other vermin will not be covered by the warranty.

### Correct installation

▶ When installing the refrigeration appliance, it is a mandatory requirement to follow the operating instructions.

▶ Change the door hinging (if necessary) as described in the installation instructions.

▶ Refrigeration appliances with an "S" in the model identifier can be installed next to each other as a side-by-side combination:

## Warning and Safety instructions

---

- Carry out installation as described in the installation instructions.
- Do not change the door hinging as the arrangement of the refrigeration appliances is predefined.
- ▶ Always wear protective gloves when transporting and setting up the refrigeration appliance and when changing the door hinging.
- ▶ The refrigeration appliance is heavy and can tip forwards when the appliance door(s) is (are) open:
  - At least 2 people are required to transport or move the refrigeration appliance.
  - At least 2 people are required to change the door hinging of the refrigeration appliance.
  - At least 2 people are required to install the refrigeration appliance.
  - Never leave the refrigeration appliance unattended while it is being installed.

### Correct use

- ▶ This refrigeration appliance is designed for use within specific ambient temperatures (climate range). Do not use it in ambient temperatures for which it is not designed. The climate class is stated on the data plate inside the refrigeration appliance. A lower ambient temperature will cause the compressor to switch off for longer periods, meaning that the refrigeration appliance is unable to maintain the required temperature.
- ▶ The ventilation cross-sections must not be covered or blocked in any way. This can impair the proper ventilation of the appliance, increase the energy consumption and cause damage to the components.
- ▶ Risk of damage due to greasy or oily foods. If the refrigeration appliance or the appliance door is used for storing food which contains fat or oil, make sure that it does not come into contact with plastic components. Any spillages of oil or fat could cause stress cracks to the plastic and cause it to break or split.

## Warning and Safety instructions

---

- ▶ Risk of fire and explosion due to flammable mixtures of gases. Do not store any explosive materials or products containing flammable propellants (e.g. spray cans) in the refrigeration appliance. Electrical components can cause flammable mixtures of gases to ignite. The spray cans in question can be identified by the contents printed on the can or by a flame symbol. Electrical components can cause escaping gases to ignite.
- ▶ Danger of explosion. Do not operate any electrical equipment (e.g. an electric ice cream maker) inside the refrigeration appliance. This can cause sparking and explosion.
- ▶ Food stored for too long may present a risk of food poisoning. Storage times will depend on several factors, including the freshness and quality of the food, as well as the temperature at which it is stored. Follow the instructions given on the food manufacturer's packaging regarding storage conditions and use-by dates.

### **Stainless steel appliances**

- ▶ The coated stainless steel surface can be damaged by adhesives and will lose its dirt-repelling properties. Do not adhere sticky notes, transparent tape, masking tape or other adhesives onto the stainless steel surface.
- ▶ The surface is susceptible to scratching. Even magnets can cause scratches.

### **Accessories and spare parts**

- ▶ We recommend using original Miele accessories. Using spare parts or accessories from other manufacturers will invalidate the warranty and Miele cannot accept liability.
- ▶ Miele original spare parts are kept in stock for at least 10 years and up to 15 years after discontinuation of your refrigeration appliance.

### **Cleaning and care**

- ▶ Do not use any oils or grease on the door seals, as these will cause the seals to deteriorate and become porous with time.
- ▶ Do not use a steam cleaning appliance to clean this appliance. Steam could reach the electrical components and cause a short circuit.

## Warning and Safety instructions

---

- ▶ **Warning:** Do not use any mechanical tools or other types of aid which are not recommended by the manufacturer to accelerate the defrosting process.
- ▶ Sharp edged or pointed objects will damage the evaporator, causing irreversible damage to the appliance. Do not use sharp edged or pointed objects to
  - remove frost and ice, or accelerate the defrosting process,
  - separate frozen foods and remove ice trays.
- ▶ Never place electric heaters or candles in the appliance to defrost it. These can damage the plastic parts.
- ▶ Do not use defrosting sprays or de-icers. Defrosting sprays and de-icers can contain substances which could damage the plastic parts or which might cause a build-up of explosive gases and pose a danger to health.

### Transport

- ▶ To avoid damage to the refrigeration appliance, always transport it upright and in its packaging.
- ▶ Risk of injury and damage! The refrigeration appliance is very heavy and must be transported by two people.

### Disposal of your old appliance

- ▶ Children playing could become trapped in the refrigeration appliance and could suffocate.
  - Remove the appliance door(s).
  - Remove the drawers.
  - Leave the adjustable shelves in the refrigeration appliance so children cannot climb inside.
  - If your old refrigeration appliance has a door lock, destroy it. This way you will prevent the risk of playing children accidentally locking themselves in and endangering their lives.
- ▶ Risk of electric shock!
  - Cut the electrical plug off the power supply cord.
  - Cut the power supply cord off the old appliance.

Dispose of the electrical plug and power supply cord separately from the old appliance.

## Warning and Safety instructions

---

▶ During and after disposal, make sure that the refrigeration appliance is not placed near petrol or other flammable gases and liquids.

▶ Risk of fire due to escaping oil or refrigerant.

The refrigerant and oil inside the appliance are flammable. In high enough concentrations, escaping refrigerant or oil can ignite if they come into contact with an external heat source.

During disposal, make sure that the cooling circuit is not damaged. This prevents refrigerant and oil escaping in an uncontrolled manner (see the data plate for details of the refrigerant).

▶ Splashes of coolant can damage the eyes. Be careful not to damage any part of the pipework whilst awaiting disposal, e.g. by

- puncturing the refrigerant channels in the condenser,
- bending any pipework, or
- scratching the surface coating.

### Symbol on the compressor (depending on model)

This information is only relevant for recycling. There is no risk during normal operation.



▶ The oil in the compressor can be fatal if swallowed or if it penetrates the airways.

## Disposal of the packing material

The transport and protective packaging has been selected from materials which are environmentally friendly for disposal, and can normally be recycled.

Recycling the packaging reduces the use of raw materials in the manufacturing process and also reduces the amount of waste in landfill sites.

Ensure that any plastic wrappings, bags etc. are disposed of safely and kept out of the reach of babies and young children. Danger of suffocation.

**Only for Australia:** Note for installer: Expanded polystyrene (EPS) packaging included. Please retain and dispose of EPS packaging responsibly. For further information, please contact Miele.

## Disposing of your old appliance

Electrical and electronic appliances contain many valuable materials. They also contain certain materials, compounds, and components which were essential for their correct functioning and safety. These could be hazardous to human health and to the environment if disposed of with general waste or if handled incorrectly. Please do not, therefore, dispose of your old appliance with your household waste.



Take care not to damage your refrigeration appliance before or during disposal in an authorised, environmentally friendly manner.

This is to ensure that refrigerant in the cooling circuit and oil in the compressor is contained, and will not leak into the environment.

Please dispose of it at your local community waste collection/recycling centre for electrical and electronic appliances, or contact Miele. You are also responsible for deleting any personal data that may be stored on the appliance prior to disposal. You should remove any old batteries which are not securely enclosed by the appliance and remove any lamps without destroying them, where this is possible. These must be taken to a suitable collection point where they can be handed in free of charge. Please ensure that your old appliance presents no danger to children while being stored awaiting disposal.

# Sustainability and environmental protection

---

## How to save energy ...

- Installation site** The refrigeration appliance has to cool more often at higher ambient temperatures and consumes more energy in the process. Therefore:
- Install the refrigeration appliance in a well-ventilated room.
  - Do not install the refrigeration appliance near to a heat source (heater, cooker).
  - Protect the refrigeration appliance from direct sunlight.
  - Ensure an ideal ambient temperature of 20 °C.
  - Clean the ventilation openings on a regular basis to remove any dust.
- Temperature setting** The colder the temperature, the higher the energy consumption. The following settings are recommended:
- 4 to 5 °C in the refrigerator section.
- Use** Energy consumption is increased by heat input and impeded air circulation. Therefore:
- Only open the appliance door/appliance doors when necessary and for as short a time as possible. Arrange the food in such a way that makes it easy to find in the appliance.
  - Always close the appliance door/appliance doors properly after opening it/them.
  - Allow hot food and drinks to cool down before placing them in the refrigeration appliance.
  - Store food well packaged or covered.
  - Do not overfill the compartments to allow air to circulate.
  - Keep drawers and shelves arranged as they were when the appliance was delivered.
  - Place frozen food in the refrigerator section to defrost.
  - Maintain a distance of 25 mm between the back of the appliance and the wall.

## Installation site

 Fire hazard and risk of damage from appliances that give off heat. Appliances that give off heat can catch fire and set fire to the refrigeration appliance. The power supply cord must not come into contact with heat sources. Do not place appliances which give off heat, such as mini-ovens, double burner cooktops or toasters on the refrigeration appliance.

 Fire risk and danger of damage from open flames! Open flames can set fire to the refrigeration appliance. Keep open flames (e.g. a candle) away from the refrigeration appliance.

 Risk of fire and damage due to improper installation. If the mains plug and power supply cords touch the back of the refrigeration appliance, they may be damaged by vibrations and cause a short circuit. Mains plugs or power supply cords must not touch the refrigeration appliance. Power supply cords must not be trapped or damaged. Do not connect any other appliances to sockets located directly behind this refrigeration appliance. Do not place or operate multi-socket adapters, distributor strips or other electronic devices (such as halogen transformers) behind the appliance.

This appliance should be installed in a dry, well-ventilated room.

The floor at the installation site must be horizontal and level and must be as high as the surrounding floor.

 Risk of damage due to high humidity.

In environments with high humidity, condensation can build up on external refrigeration appliance panels.

This condensate can cause corrosion on external appliance panels.

Install the refrigeration appliance in a dry and/or air-conditioned room with sufficient ventilation.

After installation, please make sure that the appliance door/appliance doors closes/close properly and the refrigeration appliance is installed in accordance with these installation instructions. It is essential to comply with the specified ventilation cross-section requirements.

When deciding on the installation site, please bear in mind that your refrigeration appliance will consume more energy if installed near to a heater, a cooker or another appliance that gives off heat. Avoid direct sunlight. Higher ambient temperatures increase energy consumption as the compressor runs for longer.

### Climate range

This refrigeration appliance is designed for use within specific ambient temperatures (climate range). Do not use it in ambient temperatures for which it is not designed. The climate class is stated on the data plate inside the refrigeration appliance.

# Installation

Climate range	Ambient temperature
SN	10 to 32 °C
N	16 to 32 °C
ST	16 to 38 °C
T	16 to 43 °C
SN-ST	10 to 38 °C
SN-T	10 to 43 °C

A lower ambient temperature leads to the compressor switching off for longer periods. This can cause the internal temperature in the appliance to rise with the risk of food deteriorating and going off.

## Ventilation requirements

**⚠** Risk of fire and damage due to inadequate ventilation.

If the refrigeration appliance is not ventilated sufficiently, the compressor will run more frequently and for longer periods. This causes increased energy consumption and an increased compressor operating temperature, which can result in damage to the refrigeration appliance.

Please ensure that there is adequate ventilation around the refrigeration appliance.

It is essential to observe the required ventilation openings.

The ventilation openings must not be covered or blocked in any way.

Clean the ventilation areas regularly to remove dust and dirt.

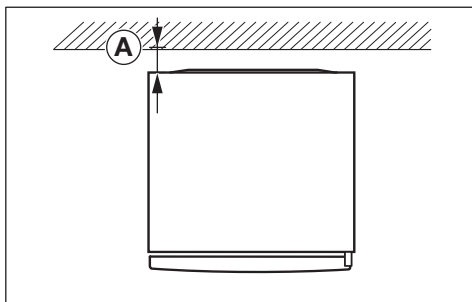

The energy consumption was calculated with a distance **A** = 25 mm between the back of the appliance and the wall. If the distance to the wall is less than 25 mm, the functionality of the refrigeration appliance is maintained, but energy consumption increases slightly.

Air at the back of the refrigeration appliance gets warm. Sufficient space for proper ventilation must therefore be ensured (see “Appliance dimensions”).

## Installing several refrigeration appliances next to one another

**⚠** Risk of damage due to condensation on the external appliance panels.

In environments with high humidity, condensation can build up between the external refrigeration appliance panels, which can cause corrosion.

Do **not** place different refrigeration appliances **directly** next to one another.

A distance of at least 70 mm must be maintained between the refrigeration appliances.

## Side-by-side installation

Your refrigerator can be installed to the right of a freezer as it is equipped with an integrated heater in the left-hand side panel (see “Appliance dimensions”).

The freezer must also be equipped with an integrated heater in the right-hand side panel.

Depending on the model, the appropriate side-by-side installation kit will be provided with the freezer. The installation instructions describe how to install the refrigeration appliances next to each other.

**Useful tip:** Please contact Miele for information on which combinations are suitable for your appliance.

## Door hinging change

 Danger of injury and damage to the appliance due to heavy door. There is an increased danger of injury and damage if the door hinging is installed by a single person. Always change the door hinging with the help of a second person.

 Risk of damaging the electrical components. There are live components on the door hinge (depending on the model). Switch off the appliance at the wall socket and withdraw the mains plug before changing the hinging.

 Carry out the door hinging change in accordance with the installation instructions (see QR code).



M.-Nr. 12083770

## Ordering printed installation instructions

You can order printed installation instructions free of charge from Miele. All the contact information you need for Miele can be found at the end of this document. Quote the model identifier and the serial number from the data plate when placing your order.

## Installing the refrigeration appliance

 Risk of injury and damage due to the refrigeration appliance tipping over.

There is an increased risk of injury and damage if the refrigeration appliance is installed by a single person.

Two people are required for installing the refrigeration appliance.

 Risk of damage to the appliance door caused by impact.

The appliance door could hit the wall of the room resulting in damage to the door.

Protect the appliance door by fitting a felt stopper, for example, to the wall of the room.

## Installation

**⚠ Risk of damaging the floor.**  
Moving the refrigeration appliance can cause damage to the floor.  
Move the appliance carefully on floors that are sensitive to scratching.

For easier installation, there are transport handles on the back at the top and transport wheels underneath the refrigeration appliance (depending on the model).

The refrigeration appliance must be empty when it is installed.

- Connect the refrigeration appliance to the mains power supply as described in “Electrical connection”.
- Move the refrigeration appliance carefully to its intended installation site.
- Position the refrigeration appliance with its back facing the wall, taking the necessary distance into account.

### Aligning the appliance

**⚠ Risk of damage and danger of injury due to the appliance door swinging open or the refrigeration appliance tipping over.**

If the additional adjustable foot on the hinge plate at the bottom is not resting firmly on the floor, the appliance door may swing open or the refrigeration appliance can tip over.

Use the open spanner supplied with the appliance to unscrew the adjustable foot until it is resting on the floor.

Then unscrew it by a further quarter turn.

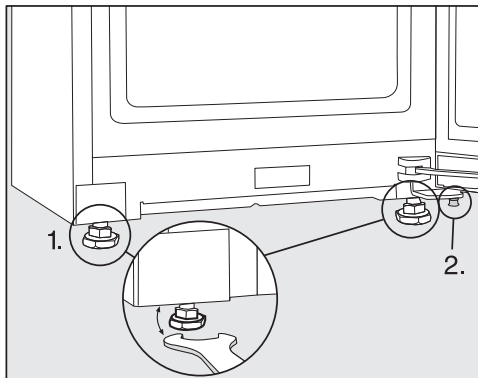

- Use a spirit level and the open spanner supplied to align the refrigeration appliance and support the appliance door.
  1. Adjust the front adjustable feet.
  2. Unscrew the additional adjustable foot until it is touching the floor. Then unscrew it by a further quarter turn.

## Integrating the refrigeration appliance in a run of kitchen units

The refrigeration appliance can be surrounded by kitchen units.

The energy consumption was calculated with a distance of 25 mm between the back of the appliance and the wall. If the distance to the wall is less than 25 mm, the functionality of the refrigeration appliance is maintained, but energy consumption increases slightly.

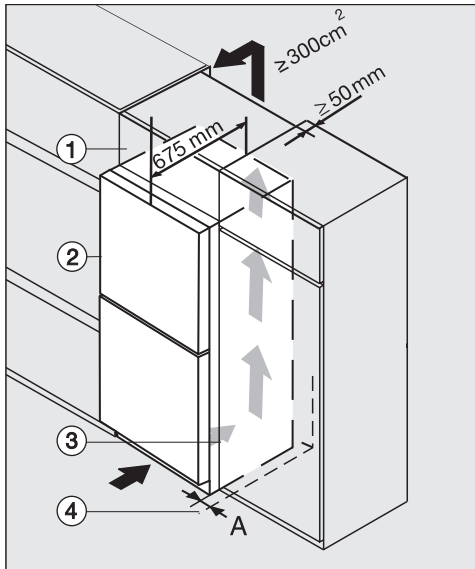

K(S)/FN(S)/KFN 4xxx X **edst/cs, bst**

- ① Top box
- ② Refrigeration appliance, door depth = 75 mm
- ③ Kitchen unit
- ④ Wall
- A** = 25 mm (with recessed grip)/60 mm (with handle)

 Risk of fire and damage due to inadequate ventilation.

If the refrigeration appliance is not ventilated sufficiently, the compressor will run more frequently and for longer periods. This causes increased energy consumption and an increased compressor operating temperature, which can result in damage to the refrigeration appliance.

Please ensure that there is adequate ventilation around the refrigeration appliance.

It is essential to observe the required ventilation openings.

The ventilation openings must not be covered or blocked in any way.

Clean the ventilation areas regularly to remove dust and dirt.

The larger the ventilation openings, the less energy the compressor will use.

- Install the refrigeration appliance next to the kitchen unit.

# Installation

---

- The appliance front must protrude in front of furniture fronts by at least the door depth. This enables the appliance door to be opened and shut without being obstructed.
- When installed next to a wall ④, a distance (**A**) must be maintained on the hinge side between the wall ④ and the refrigeration appliance ②.
- To match the height of the rest of the kitchen units, the refrigeration appliance can be fitted with a suitable top box ①.

An air outlet of 50 mm depth must be provided across the whole width of the top box.

The ventilation cross-section under the ceiling must be at least 300 cm<sup>2</sup> to ensure that warm air can escape without obstruction.

## Appliance dimensions

### Installation dimensions/View from above

KS 4383 ... edt/cs

All dimensions are given in mm.

The refrigeration appliance will function correctly if the specified ventilation cross-sections are kept clear.

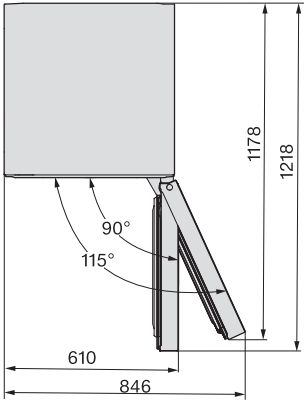
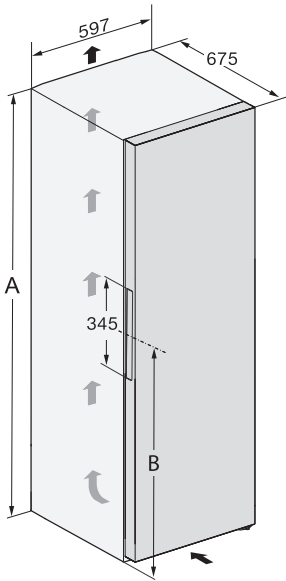

	<b>A</b>	<b>B</b>
KS 4383 ED edt/cs	1850	1061

# Installation

---

## Connections

KS 4383 ... edt/cs

All dimensions are given in mm.

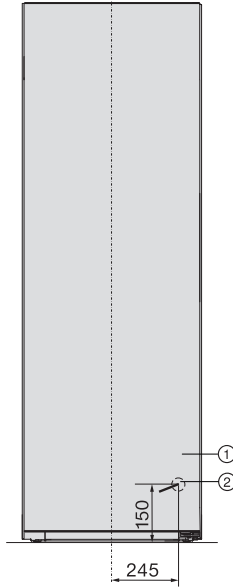

- ① Front view
- ② Mains connection cable, length = 2,000 mm  
A longer mains connection cable is available from Miele.

## Installation dimensions/View from above

FNS 4382 ... edt/cs + KS 4383 ... edt/cs

For more information, see “Installing multiple refrigeration appliances – Side-by-side installation” and the installation instructions supplied with the side-by-side installation kit.

All dimensions are given in mm.

The refrigeration appliances will function correctly if the specified ventilation cross-sections are kept clear.

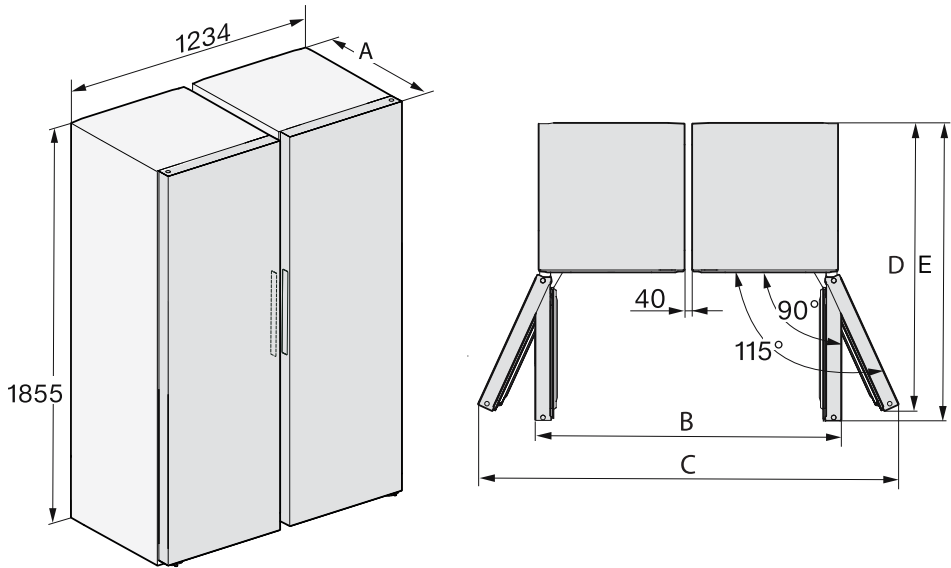

	<b>A</b>	<b>B</b>	<b>C</b>	<b>D</b>	<b>E</b>
FNS 4382 ... + KS 4383 ...	675	1260	1732	1178	1218

# Installation

## Electrical connection

The refrigeration appliance must only be connected to an earthed socket using the connection cable supplied.

The socket should be easily accessible after the refrigeration appliance has been installed. If the socket is not easily accessible, ensure that a suitable means of disconnection is provided on the installation side for each pole.

**⚠ Risk of fire from overheating.**

Connecting the appliance to a multi-socket plug adapter or to an extension lead can overload the cable.

For safety reasons, do not use an extension cable or multi-socket adapter.

All electrical work must be carried out by a suitably qualified and competent person in strict accordance with national and local safety regulations.

For safety reasons, we recommend using a suitable residual current device (RCD) in the relevant electrical installation for connecting the refrigeration appliance.

If the mains connection cable is damaged, it must only be replaced with a specific mains connection cable of the same type (available from Miele).

The data plate indicates the nominal power consumption and the connection data. Compare this information with the data of the on-site electrical connection. If in any doubt, consult a qualified electrician.

Temporary or permanent operation with a self-sufficient or non-mains synchronous energy supply system (e.g. isolated networks, back-up systems) is possible. A requirement for the

operation is that the energy supply system complies with all current local and national requirements that apply to stand-alone, solar and/or battery systems.

The protective measures provided in the domestic installation and in this Miele product must also be assured in their function and operation in isolated operation or in non-mains synchronous operation, or replaced with equivalent measures in the installation.

## Connecting the appliance

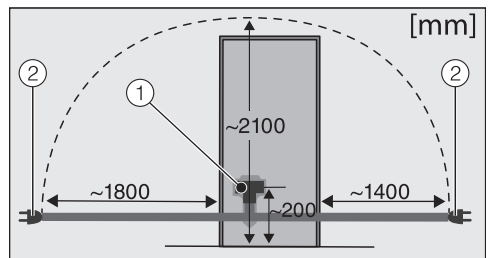

Back of the refrigeration appliance

- ① Appliance plug connector
- ② Mains plug

■ Plug the appliance plug connector into the appliance socket.

Make sure that the plug connector has locked into position correctly.

■ Insert the mains plug of the appliance into the socket and switch it on.

The appliance is now connected to the electricity supply.

## Appliance overview

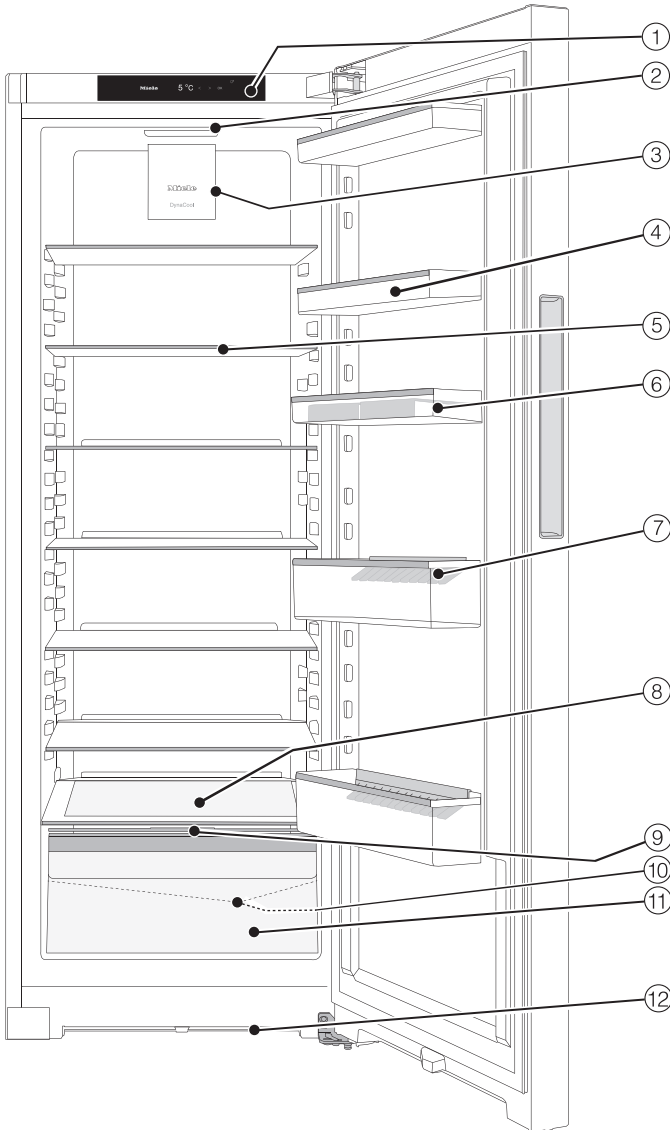

Picture shows an example of an appliance model.

# Guide to the appliance

---

- ① Display
- ② Interior lighting
- ③ Fan
- ④ Door shelves
- ⑤ Adjustable shelf
- ⑥ Egg tray  
Clip the egg tray onto the rear edge of the door shelf.
- ⑦ Bottle shelf with bottle holder:  
You can move the bottle holder to the right or left to create space for drinks cartons.
- ⑧ Space for a baking tray (XL interior)
- ⑨ Compartment cover for setting the humidity level in the DailyFresh drawer
- ⑩ Condensate channel and condensate drain hole:  
Precipitated condensate runs off and evaporates automatically.
- ⑪ DailyFresh drawer for fruit and vegetables (with moisture adjustment)
- ⑫ Ventilation gap



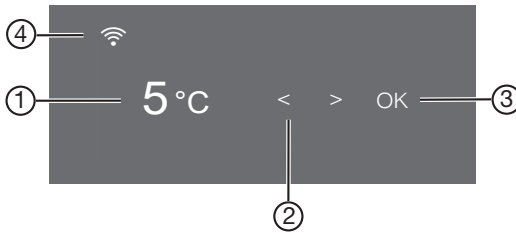



## Control panel with display



- ① Temperature display for the refrigerator section
- ② Sensors for selecting a setting
- ③ *OK* sensor for confirming a selection and accessing Settings mode ⚙️
- ④ Display for connection status (depending on model) (only visible if networking has been set up)











### Settings mode ⚙️

In Settings mode, you can select the following appliance functions and alter their settings to some extent:

Symbol	Function	Factory default setting
	Switching the Party mode function on or off (see “Selecting further settings”)	Off
	Switching the Holiday mode function on or off (see “Selecting further settings”)	Off
	Switching the lock function on or off (see “Selecting further settings”)	 (Off)
	Switching off the refrigeration appliance	—
	Switching the Sabbath mode function on or off (see “Selecting further settings”)	Off

## Guide to the appliance

---

	Calling up the Sabbath mode version	—
	Changing the time before the door alarm is triggered (see “Selecting further settings”)	1:00
	Switching the keypad tone on or off	On
	Changing the volume of the alarms and buzzers or switching them off entirely (see “Selecting further settings”)	On /Level 5
	Changing the display brightness (see “Selecting further settings”)	Level 4
	Changing the temperature unit (°Celsius or °Fahrenheit)	°C
	Switching the Demo mode function off (only visible when switched on) (see “Selecting further settings”)	Off
	Resetting to default settings (see “Selecting further settings”)	—
	Call up information (model identifier and serial number) about your refrigeration appliance (see “Selecting further settings”)	—
	Switching on the reminder to change the charcoal filters (see “Optional accessories”) (see “Selecting further settings”)	Off
	Switching Cleaning mode on or off (see “Cleaning and care” and “Selecting further settings”)	Off

## Adjusting the interior fittings

### Moving the door/bottle shelf

Only move the door/bottle shelves in the appliance door when they are empty.

- Push the door/bottle shelf upwards, then remove it by pulling it forwards.
- Refit the door/bottle shelf at the required height.

### Moving the adjustable shelves

The shelves can be adjusted according to the height of the food.

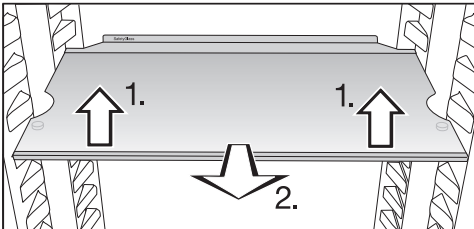

- Raise the shelf slightly at the front and pull it forwards a little.
- Lift it until the notches at the side are in line with the shelf supports. The shelf can then be raised or lowered to the required level.
- Push the shelf in.

Stoppers prevent the shelves from being dislodged by mistake.

The raised edge on the protective strip at the back must face upwards to prevent food from touching the back wall of the appliance and freezing to it.

### Space for a baking tray

A baking tray can be placed above the drawers. The baking tray can be no more than 466 mm wide, 386 mm deep and 50 mm high.

- Open the appliance door as far as it will go.

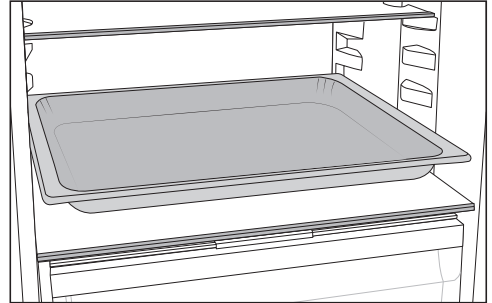

- Place the baking tray on the dividing plate.

**Useful tip:** Let the baking tray cool down to room temperature before putting it in the refrigerator section.

### Moving the Active AirClean filters

The holder for the Active AirClean filters sits on a protective strip at the back of the shelf.

- To move an Active AirClean filter, pull it upwards to remove it from the protective strip.

# Guide to the appliance

---

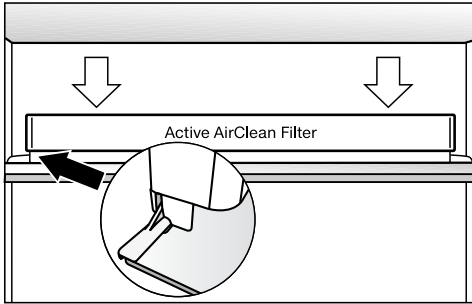

- Refit the Active AirClean filter on the protective strip of the shelf you wish to use it on.

## Accessories supplied

### Egg tray

### Bottle holder

## Optional accessories

A range of useful Miele accessories and care products is available for your appliance.

Products specially tailored to your refrigeration appliance – such as appliance care products and accessories – are available from the Miele online shop and Miele Customer Service.

You can access the Miele online shop via the following QR code:



## Before using for the first time

- Remove all packaging material and protective film.
- Clean the inside of the appliance and the accessories.

## Connecting the appliance

- Connect the appliance to the electricity supply as described in "Electrical connection".

Miele will then appear in the appliance display, followed by .

## Switching on the appliance

- Open the appliance door.
- Touch the *OK* sensor on the control panel.

The appliance will start to cool and the interior lighting will come on when the door is opened.

The refrigeration appliance will adjust to the preset temperature.

To enable the temperature to get sufficiently cold inside the refrigeration appliance, allow the appliance to run for a few hours. Do not place food in the refrigeration appliance until it has reached the preset temperature.

## Switching off the appliance

- Touch the *OK* sensor on the control panel.

 appears in the display.

- Touch *OK*.
- Use the *<* sensor to scroll to the  symbol.
- Touch *OK*.

 appears in the display.

The cooling and interior lighting are switched off.

Please note: The refrigeration appliance is not disconnected from the mains power supply when it is switched off.

## Switching off for longer periods of time

If, during a long absence, the refrigeration appliance is switched off but not cleaned and the door is left shut, there is a danger of mould building up inside the appliance. It is essential to clean the refrigeration appliance if it is not going to be used for a long time.

If the appliance is not going to be used for a longer period of time, observe the following:

- Switch the appliance off.
- Switch off at the wall and withdraw the plug from the socket, or switch off the mains circuit breaker.
- Clean the refrigeration appliance and leave the door ajar to air the appliance and avoid odours building up inside.

# Operation

## The correct temperature

It is very important to set the correct temperature to ensure the shelf life of food. Reducing the temperature reduces the growth rate of microorganisms. Food does not spoil as quickly.

The temperature in the appliance will rise:

- the more often the door is opened and the longer it is kept open.
- the more food is stored in it.
- the warmer the food is which is being put into it.
- the higher the ambient temperature surrounding the refrigeration appliance. This refrigeration appliance is designed for use within specific ambient temperatures (climate range). Do not use it in ambient temperatures for which it is not designed.

### ... in the refrigerator section

We recommend a temperature of **4 °C** in the refrigerator section.

### Temperature display

In normal operation, the temperature display shows the **current mean temperature** in the refrigerator.

Depending on the ambient temperature and the temperature setting, it can take the appliance a few hours to reach the temperature required and for this temperature to then be shown constantly in the display.

### Setting the temperature

- Touch the *OK* sensor on the control panel.

🌡️ appears in the display.

- Touch *OK*.

- Use the < and > sensors to change the temperature.
- Touch *OK*.

The temperature display will then change back to the current temperature in the refrigeration appliance.

### Possible temperature settings

- Refrigerator section: 2 to 9 °C

### Door alarm

The refrigeration appliance is fitted with a door alarm to avoid increased energy consumption and food becoming warm if the appliance door is left open.

If the appliance door is left open for a longer period of time, 🚪🔺 will appear in the temperature display. An alarm will also sound and the interior lighting will flash.

The time before the door alarm is triggered can be changed (see “Selecting further settings”).

The door alarm’s audible signal can be switched off (see “Selecting further settings”).

The alarm will stop and 🚪🔺 will go out in the display as soon as the appliance door is closed.

### Switching the door alarm off early

- Tap *OK*.

🚪🔺 goes out and the alarm will stop. The interior lighting will light up constantly.

If the appliance door is not closed, the door alarm will sound again after around 1 minute.

## Using SuperCool and DynaCool

### SuperCool ❄️

When switched on, the SuperCool ❄️ function can be used to rapidly reduce the temperature in the **refrigerator section** to its lowest setting (depending on the ambient temperature). The refrigeration appliance will work at full power and lower the temperature. Select this function for the rapid chilling of large amounts of fresh food or drink.

When the SuperCool ❄️ function is switched on, the appliance may make more noise than usual.

The SuperCool ❄️ function should be switched on immediately before placing food or drinks in the refrigerator section.

The SuperCool ❄️ function will switch itself off automatically after approx. 12 hours. The appliance will then run at normal power again.

**Useful tip:** To save energy, you can switch off the SuperCool ❄️ function yourself once food and drinks are sufficiently chilled.

### Switching SuperCool ❄️ on and off

■ Touch the *OK* sensor on the control panel.

🌡️ appears in the display.

■ Touch *OK*.

■ Use the < sensor to scroll to the ❄️ symbol.

■ Touch *OK*.

When the SuperCool function ❄️ is **switched on**, a dot appears in the upper corner of the display °.

### DynaCool 🌀

When the DynaCool function 🌀 is not switched on, the natural circulation of air in the appliance will cause different temperature zones in the fridge, as the cold, heavy air will sink to the lowest section of the appliance. Make use of the different temperature zones when placing food in the refrigerator (see "Storing food in the refrigerator section").

However, if you are storing a large amount of similar food in the refrigerator at any one time, e.g. after your weekly shop, it is a good idea to switch on DynaCool. This way you can distribute the temperature on all the adjustable shelves inside the appliance more evenly so that all the food in the refrigerator section will be chilled to about the same degree.



The temperature can be set as usual with the temperature control.

Also switch on the DynaCool function 🌀 when:

- the ambient temperature is high (above approx. 35 °C)
- the humidity levels are high (e.g. in the summer)

The fan will always switch on automatically when the compressor switches on.

# Operation

**Useful tip:** As the energy consumption increases when DynaCool  is switched on, you should switch the DynaCool function  off again under normal conditions.

To save energy, the fan switches off automatically when the door is open.

## Switching DynaCool on and off

■ Touch the *OK* sensor on the control panel.

 appears in the display.

■ Touch *OK*.

■ Use the < sensor to scroll to the  symbol.

■ Touch *OK*.

When the DynaCool function  is **switched on**, a dot appears in the upper corner of the display •.

## Storing food in the refrigerator section

### Different storage zones

Due to the natural air circulation, there are different temperature zones in the refrigerator section.

Cold, heavy air sinks to the lowest section of the refrigerator section. Make use of the different zones when placing food in the appliance.

This is a refrigeration appliance with dynamic cooling. When the fan is running, the cold is evenly distributed in the refrigerator section. The difference between the various temperature zones is less pronounced.

### Warmest area

The warmest area is located in the top section of the main storage area and the door. Use this for storing butter so that it remains spreadable and for cheese so that it retains its flavour.

### Coldest area

The coldest area in the refrigerator section is directly above the DailyFresh drawer and at the back of the appliance.

A temperature setting of 4 °C combined with appropriate hygiene measures delays the propagation of bacteria, e.g. salmonella and listeria, which can lead to serious food poisoning.

Therefore, you should use these areas to store all delicate and highly perishable food, including:

- fish, meat, poultry
- sausage products, ready meals

- dishes or baked goods containing eggs or cream
- fresh dough, cake mixtures, pizza or quiche dough
- soft cheese and other dairy products
- hummus, vegetable spreads, plant-based cream cheese substitutes
- pre-packed vegetables
- other fresh food (with a label stating it should be kept at a temperature of approx. 4 °C)

**Useful tip:** Store food in such a way that it does not touch the rear panel of the refrigerator section. Otherwise it could freeze to the rear panel.

### **Should food be stored loose or in packaging?**

Ensure that food stored in the refrigerator section is in packaging or covered properly (some exceptions apply in the DailyFresh drawer). This will prevent food odours from affecting other food, stop food from drying out, and also prevent any cross-contamination of germs. This is particularly important when storing meat products. Make sure that food such as raw meat and fish in particular does not come into contact with other food.

By ensuring that the temperature settings are correct and by taking appropriate hygiene measures, you can prolong the storage life of your food considerably. This prevents food waste.

### **Protein rich food**

Please note that foods rich in protein deteriorate faster than others. Shellfish, for example, deteriorates faster than fish, and fish deteriorates faster than meat.

### **Storing food in the DailyFresh drawer**

The DailyFresh drawer provides good storage conditions for fruit and vegetables.

The humidity level in the DailyFresh drawer can be regulated to suit the food being stored. Food retains its own moisture if stored at a higher humidity and does not dry out as quickly. The temperature is approximately equivalent to the temperature in the refrigerator section.

Remember that the freshness of the food when first placed in the appliance is the most important factor in determining how long it will stay fresh.

### **Adjusting the humidity level in the DailyFresh drawer for fruit and vegetables**

The moisture level greatly depends on the type and quantity of food being stored, if stored unwrapped. If the quantity of food being stored in this compartment is small, the humidity level may be too low.

**Useful tip:** If you are only storing a small amount of food, wrap it in airtight packaging.

# Operation

---

## Selecting low humidity $\Delta$

The appliance is delivered with increased humidity and the compartment cover pushed backwards  $\Delta\Delta\Delta$ .

Only change this default setting if the humidity level in the DailyFresh drawer is too high.

- Open the DailyFresh drawer.

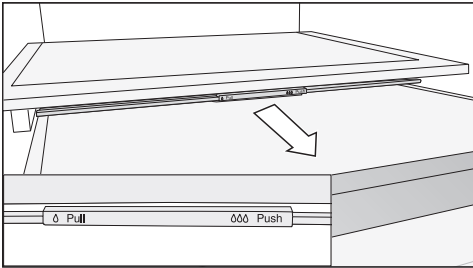

- Pull the compartment cover forwards as far as it will go.

The compartment cover is open and the humidity decreases  $\Delta$ .

## Selecting increased humidity $\Delta\Delta\Delta$

- Open the DailyFresh drawer.

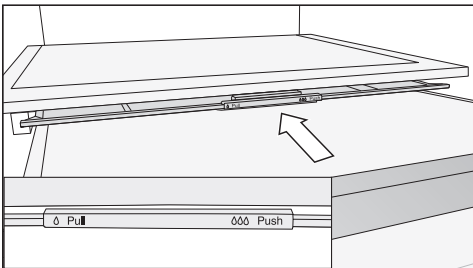

- Slide the compartment cover backwards as far as it will go.

The compartment cover is closed and the humidity remains in the compartment  $\Delta\Delta\Delta$ .

## Selecting further settings





### Explanation of the different settings



Only the settings that require further explanation are described below.



The door alarm and other warnings are automatically suppressed when you are in Settings mode .

### Party mode

The Party mode function  is particularly recommended for the rapid chilling of large amounts of fresh food or drink.

**Useful tip:** Switch on the Party mode function  approx. 4 hours before placing food and drinks in the appliance. When Party mode  is switched on, the DynaCool  and SuperCool  functions are switched on automatically.

Party mode  cannot be switched on if Holiday mode  is switched on.

The Party mode function  will switch itself off automatically after approx. 24 hours. However, you can switch the Party mode function  off early at any time.

### Holiday mode

The Holiday mode function  is useful when you go on holiday, for example, if you do not wish to switch off the refrigerator section completely or do not need a high degree of cooling.

If Holiday mode  is switched on, this will be indicated in the start display.

The refrigerator section is regulated to a temperature of 15 °C. In this way, the refrigerator section remains in operation whilst saving energy.

Food which does not go off quickly can be stored in the refrigeration appliance for some time at this moderate refrigerator temperature. Energy consumption is lower than in normal operation.

This also prevents the build-up of odours and mould, which can occur if the refrigerator section is switched off and the appliance door is closed.

 Health risk due to consumption of spoiled food.

The shelf life and quality of food in the refrigerator section may deteriorate if the temperature remains above 4 °C for an extended period.



Only ever switch on the Holiday mode function  for a limited period.



Do not store any temperature-sensitive food which goes off easily such as fruit, vegetables, fish, meat and dairy products during this time.

### Switching the lock function / on

When the lock function is switched on, it protects the refrigeration appliance from being switched off unintentionally and being adjusted unintentionally by unauthorised persons, e.g. children.

## Selecting further settings

- In Settings mode , use the < or > sensor to scroll to the  symbol.
- Touch *OK*.

When the safety lock function  is switched on, a dot appears in the upper corner of the display .

- Close the appliance door. The safety lock function  will now be activated.

### Deactivating the lock function / temporarily

If you want to adjust the temperature, for example, you can deactivate the safety lock function temporarily:



- Touch *OK*.
-  will appear in the display.
- Touch the *OK* sensor for approx. 6 seconds.

 will appear in the display.

- Touch *OK*.
- Now select the required settings.
- Touch *OK*.

Closing the appliance door will reactivate the safety lock function .

### Switching the lock function / off completely

- Touch *OK*.
-  will appear in the display.
- Touch the *OK* sensor for approx. 6 seconds.
-  will appear in the display.
- Use the < or > sensor to scroll to the  symbol.
- Touch *OK*.

- Use the < or > sensor to scroll to the  symbol.
- Touch *OK*.

When the safety lock function is switched off,  appears in the display.

### Sabbath mode

The appliance offers a Sabbath mode for the purpose of religious observance. If Sabbath mode  is switched on, this will be indicated in the start display.

The display switches off after 3 seconds.

When Sabbath mode  is switched on, you cannot adjust any settings on your refrigeration appliance.

Ensure that the door is properly closed, as visual and audible alarms are switched off.

The Sabbath mode function  will switch off automatically after approx. 120 hours.

When Sabbath mode  is switched on, the following are deactivated:

- The interior lighting when the door is opened.
- All audible and visual signals.
- The temperature display.



All other functions switched on previously remain activated.



 Health risk due to consumption of spoiled food.

As power failures are not indicated while Sabbath mode  is active, food may be exposed to increased temperatures for a certain period of time. This shortens the shelf life of the food.

If there is a power failure during Sabbath mode , check the quality of the food.

### Switching Sabbath mode on

- In Settings mode , use the < or > sensor to scroll to the  symbol.
- Touch *OK*.



When the Sabbath mode function  is switched on, a dot appears in the upper corner of the display .

The display switches off after 3 seconds.

- Close the appliance door.

### Switching Sabbath mode off

- Touch the *OK* sensor.  
 will appear in the display.
- Touch *OK*.

When the Sabbath mode function  is switched on, a dot appears in the upper corner of the display .

- Touch *OK*.



When the Sabbath mode function  is switched off, the dot in the upper corner of the display goes out.

### Information on Sabbath mode

You can call up the Sabbath mode version here.



### Changing the time before the door alarm is triggered

You can set how quickly the door alarm should sound after an appliance door has been opened.

- In Settings mode , use the < or > sensor to scroll to the  symbol.
- Touch *OK*.
- Use the < and > sensors to set the time you want between 30 seconds and 3 minutes: 30 seconds.
- Touch *OK*.

### Changing the volume of the alarms and buzzers /



You can change the volume of the alarms and buzzers (e.g. in the event of a door alarm or a fault message). Alternatively, you can switch the alarms and buzzers off if you find them annoying.

- In Settings mode , use the < or > sensor to scroll to the  symbol.
- Touch *OK*.
- Use the < and > sensors to select the volume you want for alarms and buzzers.
- Touch *OK*.

When the alarms and buzzers are switched off,  will appear.

### Adjusting the display brightness

You can adjust the display brightness to the lighting conditions in the room.

- In Settings mode , use the < or > sensor to scroll to the  symbol.
- Touch *OK*.
- Use the < and > sensors to select the display brightness you want.
- Touch *OK*.

# Selecting further settings

## Switching off Demo mode



Demo mode  allows the refrigeration appliance to be presented in the showroom without the cooling system being switched on. Do not activate this setting for domestic use.

If Demo mode has been switched on as a default setting,  will appear in the display when the refrigeration appliance is switched on.

■ Touch the *OK* sensor on the control panel.

Miele will appear initially in the display, followed by the start screen.

■ Touch *OK*.

■ In Settings mode , use the < or > sensor to scroll to the  symbol.

■ Touch *OK*.

After Demo mode  has been switched off, the refrigeration appliance shuts down and must be switched on again.

## Resetting the settings to their factory default settings

All settings made on the refrigeration appliance will be reset to the factory default settings (for settings, see “Guide to the appliance”).

■ In Settings mode , use the < or > sensor to scroll to the  symbol.

■ Touch *OK*.

■ Use the > sensor to scroll to the  symbol.

■ Touch *OK*.



The refrigeration appliance shuts down and must be switched on again.

## Information

Appliance data (model identifier and serial number) is shown in the display.

Keep this appliance data to hand when reporting an appliance fault to Miele Customer Service (see “Service”)

## Charcoal filter change indicator



After inserting the charcoal filters (optional accessory), you must activate the charcoal filter change indicator  in Settings mode .

The charcoal filter change indicator  in the start display will remind you to replace the charcoal filters approx. every 6 months (see “Cleaning and care – Replacing the charcoal filters”).

## Cleaning mode

Cleaning mode  makes it easier to clean the refrigerator section (see “Cleaning and care”). The interior lighting remains switched on, even though the refrigerator section is switched off. The buzzer will stop and the symbols in the display will also go out.

If Cleaning mode  is switched on, this will be indicated in the start display.

After cleaning, Cleaning mode  must be switched off. If the appliance door is closed for more than 10 minutes, Cleaning mode  switches itself off automatically.

The data plate located inside the refrigeration appliance must not be removed. It contains information which is required in the event of a fault.

Do not let water get into the electronic unit or the lighting.

 Risk of damage due to moisture ingress.

The steam from a steam cleaning appliance can damage plastic parts and electrical components.

Do not use a steam cleaner to clean the refrigeration appliance.

## Defrosting

### Refrigerator section and DailyFresh drawer

The refrigerator section and the DailyFresh drawer defrost automatically.

## Cleaning agents

Cleaning and conditioning agents used in the interior of the refrigeration appliance must be food safe.

To avoid damaging the surfaces of your appliance, **do not use:**



- cleaning agents containing soda, ammonia, acid or chloride
- cleaning agents containing descaling agents
- abrasive cleaning agents, e.g. powder cleaners and cream cleaners
- solvent-based cleaning agents
- stainless steel cleaning agents
- dishwasher cleaners
- oven sprays

- glass-cleaning agents
- hard, abrasive sponges and brushes, e.g. pot scourers
- dirt eraser sponges
- sharp metal scrapers



We recommend using lukewarm water with a little washing-up liquid to clean the appliance.

## Preparing the refrigeration appliance for cleaning

**Useful tip:** Switch Cleaning mode  on. The cooling system in the refrigerator section is switched off, but the interior lighting remains switched on.

■ In Settings mode , use the < or > sensor to scroll to the  symbol.

■ Touch OK.

When Cleaning mode  is switched on, a dot appears in the upper corner of the display .

If Cleaning mode  is switched on, this will be indicated in the start display.

The cooling system in the refrigerator section is switched off, but the interior lighting remains switched on.

- Take any food out of the refrigeration appliance and store it in a cool place.
- Take out any removable accessories for cleaning (see “Removing and dismantling accessories for cleaning”).

## Cleaning the interior of the appliance

Clean the appliance regularly, or at least once a month.

## Cleaning and care

If soiling is left on for any length of time, it may become impossible to remove under certain circumstances. Surfaces may suffer discolouration or damage.

Remove any soiling immediately.

- Clean the **interior** with a clean sponge, lukewarm water and a little washing-up liquid.
- After cleaning, wipe with clean water and dry with a cleaning cloth.
- Clean the condensate channel and drain hole using a cotton swab or similar item.
- Leave the door open to air the refrigeration appliance sufficiently for a short while and to prevent odour build-up.

### Cleaning accessories by hand or in the dishwasher

The following components must be cleaned **by hand** only:

- the stainless steel-look trim
- the protective strips at the back of the adjustable shelves
- Adjustable shelf with printing
- All drawers and compartment covers (these vary depending on model)
- the flexible bottle rack (available as an optional accessory).
- Organisation box (available as an optional accessory)

The following components are **dishwasher-safe**:

 Risk of damage due to high dishwasher temperatures.

Parts of the refrigeration appliance may become unusable, e.g. deform, if they are washed in the dishwasher at more than 55 °C.

For dishwasher-safe components, always select dishwasher programmes with a maximum temperature of 55 °C.

Contact with natural dyes from carrots, tomatoes, and ketchup, etc. may discolour the plastic parts in the dishwasher. This discolouration does not affect the stability of the parts.

- Bottle holder, egg tray.
- the door and bottle shelves in the appliance door (without stainless steel-look trim)
- The adjustable shelves (with the trim removed and without the printing)
- The holder for the charcoal filters (optional accessory)

### Removing and dismantling accessories for cleaning

#### Dismantling the door shelf/bottle shelf

Remove the trim in stainless steel-look before cleaning the door shelf/bottle shelf in the dishwasher.

To remove the trim, proceed as follows:

- Place the door shelf/bottle shelf on the worktop.
- Pull the trim off the shelf, beginning at one side.
- After cleaning the door shelf/bottle shelf, reattach the trim.

## Dismantling an adjustable shelf

Remove the trim and the rear protective strip before cleaning the shelf. Proceed as follows:

- Place the shelf on a worktop covered with a soft material (e.g. a tea towel).

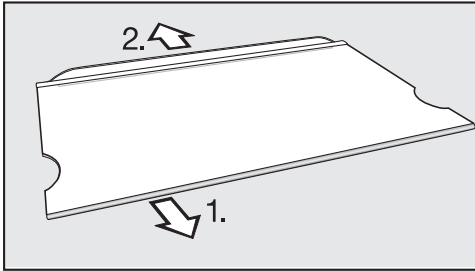

- Pull the trim off the shelf, beginning at one side.
- Pull the protective strip off.
- After cleaning the shelf, reattach the trim and the protective strip.

## Removing a drawer from the refrigerator section

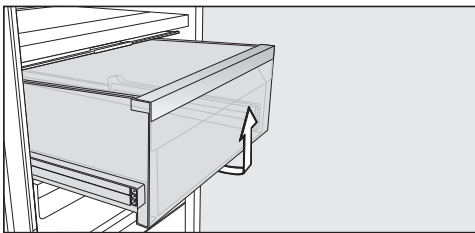

- Lift the drawer at the front and pull it out.
- After cleaning, slide the drawer back in again.

## Removing the dividing plate

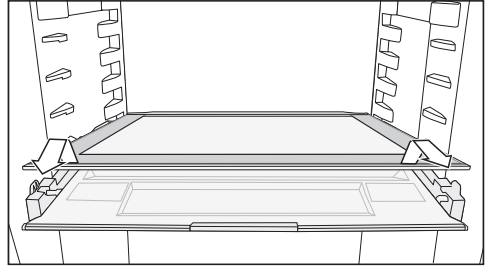

- Remove the dividing plate.
- After cleaning, slide the dividing plate back in again.

## Removing the compartment cover

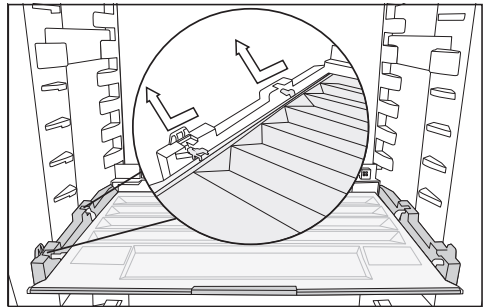

- Lift the cover at the front and pull it out.
- After cleaning, slide the compartment cover back in again.

## Replacing an Active AirClean filter (charcoal filter)

New Active AirClean filters are available from Miele Customer Service or on the Miele website.

- Pull the charcoal filter holder upwards to remove it from the shelf.

## Cleaning and care

When in position, the charcoal filters must not touch the back wall of the appliance as the moisture could cause them to stick to the back wall. Insert the new charcoal filters into the holder far enough so that they do not protrude over the edge of the holder.

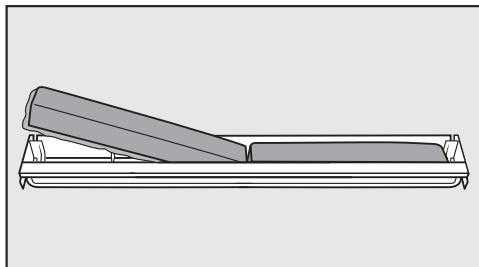

- Remove both charcoal filters and place the new filters with the surrounding edge pointing downwards in the holder.

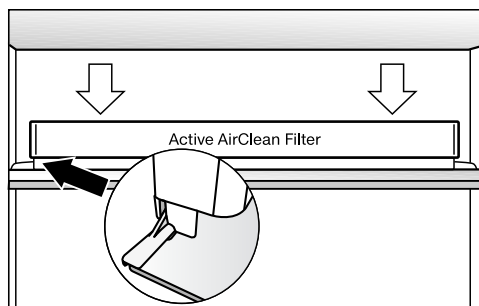

- Place the holder in the middle of the protective strip at the back of any adjustable shelf so that it clicks into position.

### Confirming that the Active AirClean filters have been changed

- Tap *OK*.

The  symbol will go out and the counter will be reset.

### Cleaning the front of the appliance and the side panels

If soiling is left on for any length of time, it may become impossible to remove. Surfaces may suffer discolouration or damage.

Therefore it is best to remove soiling from the appliance doors and side panels immediately.

All surfaces are susceptible to scratching. Contact with unsuitable cleaning agents can alter or discolour the surfaces.

See the information on “Cleaning agents” at the beginning of this section.

- Clean the surfaces with a clean sponge and a solution of warm water and washing-up liquid. A clean, damp microfibre cloth without cleaning agent can also be used.
- After cleaning, wipe with clean water and dry with a soft cloth.

### CleanSteel (edt/cs) – appliance front

 Risk of damage due to incorrect cleaning.  
The surface coating will be damaged.  
**Do not use a stainless steel cleaning agent** on this surface.

The appliance front has a high quality, special finish. It is resistant to soiling and easy to clean.

## Cleaning the door seal

 Risk of damage due to incorrect cleaning.

If you treat the door seal with oils or grease, it can become porous.



Do not use any oils or grease on the door seals.

- The door seal should be cleaned regularly with clean water, and then wiped dry with a soft cloth.

## Cleaning the ventilation openings

- The ventilation openings should be cleaned on a regular basis with a feather duster or vacuum cleaner (you could use a Miele vacuum cleaner dusting brush, for example).

## After cleaning

- Refit all removable parts and accessories in the refrigeration appliance.
- Switch the refrigeration appliance back on, if necessary.
- Switch the refrigerator section cleaning mode  off again, if necessary.
- Switch the SuperCool  function on for a while so that the refrigerator section can cool down quickly.
- Place food in the refrigerator section.
- Switch the SuperCool  function off once food and drinks are sufficiently chilled.
- Close the appliance door(s).

## Problem solving guide

Many malfunctions and faults can be easily remedied. You can save time and money in many cases, as you do not need to contact Customer Service.

More information to help you remedy faults yourself can be found at [www.miele.com.au/support/customer-assistance](http://www.miele.com.au/support/customer-assistance) or [www.miele.co.nz/support/customer-assistance](http://www.miele.co.nz/support/customer-assistance).



To prevent cold from escaping, avoid opening the appliance door until the fault has been corrected.

### Other problems

Problem	Possible cause and remedy
<b>The refrigeration appliance is not cooling.</b>	The refrigeration appliance is not switched on. ■ Switch the refrigeration appliance on.
	The mains plug is not inserted in the socket correctly or not switched on, or the plug connector is not inserted into the socket at the back of the appliance correctly. ■ Insert the mains plug into the mains socket and the plug connector into the appliance socket and switch on.
	The mains circuit breaker has tripped. There could be a fault with the refrigeration appliance, the household electrical wiring or another electrical appliance. ■ Contact a qualified electrician or Customer Service.
<b>The compressor runs continuously.</b>	This is not a fault. To save energy, the compressor runs at a lower speed when less cooling is required. This increases the running time of the compressor.
<b>The compressor is switching on more frequently and for longer periods of time. The temperature in the refrigeration appliance is too low.</b>	The appliance door has been opened too frequently. Or large amounts of fresh food have been placed in the appliance. ■ Only open the appliance door when necessary and for as short a time as possible.
	The appliance door is not closing fully. The temperature in the refrigeration appliance is dropping.

## Problem solving guide

Problem	Possible cause and remedy
	<ul style="list-style-type: none"> <li>■ Check that the appliance door is seated correctly and use the screws in the hinges to adjust it if necessary.</li> </ul>
	<p>The appliance door is not closed properly. If a thick layer of ice has already formed, this will affect cooling and increase energy consumption.</p> <ul style="list-style-type: none"> <li>■ Always close the appliance door fully.</li> <li>■ Defrost the refrigeration appliance if necessary and clean it.</li> </ul>
	<p>The ambient temperature is too high. The higher the ambient temperature, the longer the compressor runs.</p> <ul style="list-style-type: none"> <li>■ See the information in “Installation – Installation site”.</li> </ul>
	<p>The ventilation openings are covered or have become too dusty.</p> <ul style="list-style-type: none"> <li>■ Do not block the ventilation openings.</li> <li>■ Clean the dust from the ventilation openings on a regular basis.</li> </ul>
	<p>Built-in appliances: the refrigeration appliance was not properly installed in the niche.</p> <ul style="list-style-type: none"> <li>■ Install the refrigeration appliance in the niche as described in the installation instructions.</li> </ul>
<p><b>The temperature in the refrigeration appliance is too low.</b></p>	<p>The temperature setting in the refrigeration appliance is too low.</p> <ul style="list-style-type: none"> <li>■ Correct the temperature setting.</li> </ul>
	<p>The SuperCool ❄️ function is still switched on.</p> <ul style="list-style-type: none"> <li>■ You can switch off the SuperCool ❄️ function earlier to save energy.</li> </ul>
<p><b>The temperature in the refrigeration appliance is too high. The frozen food (depending on the model) could defrost.</b></p>	<p>This is not a fault. The temperature setting is too high.</p> <ul style="list-style-type: none"> <li>■ Correct the temperature setting.</li> <li>■ Check the temperature again after 24 hours.</li> </ul>
	<p>The ambient temperature is too low for this refrigeration appliance. If the ambient temperature is too low, the compressor will run less frequently. The temperature in the refrigeration appliance is rising.</p> <ul style="list-style-type: none"> <li>■ See the information in “Installation – Installation site”.</li> <li>■ Increase the ambient temperature.</li> </ul>













## Problem solving guide

Problem	Possible cause and remedy
Ice or condensation has built up inside the refrigeration appliance. The appliance door may not close correctly.	The door seal has come out of its groove. <ul style="list-style-type: none"> <li>■ Check that the door seal is correctly seated in the groove.</li> </ul>
	The door seal is damaged. <ul style="list-style-type: none"> <li>■ Check if the door seal is damaged.</li> </ul>
The door seal is damaged and needs to be replaced.	No tools are required to change the door seal. <ul style="list-style-type: none"> <li>■ Change the door seal. A replacement is available from Miele.</li> </ul>
There is no audible alarm even though the appliance door has been open for a long time.	This is not a fault. The alarm has been switched off in Settings mode. If you want to switch the audible alarm back on again: <ul style="list-style-type: none"> <li>■ Tap <i>OK</i>.</li> <li>🔊 appears in the display.</li> <li>■ Use the &lt; or &gt; sensor to scroll to the ⚙️ symbol.</li> <li>■ Tap <i>OK</i>.</li> <li>■ Use the &lt; or &gt; sensor to scroll to the 🔊 symbol.</li> <li>■ Tap <i>OK</i>.</li> <li>■ Use the &lt; and &gt; sensors to select the volume you want for alarms and buzzers.</li> <li>■ Tap <i>OK</i>.</li> </ul> <p>When the alarms and buzzers are switched on, 🔊 will appear.</p>







## Messages in the display

Message	Possible cause and remedy
■ lights up in the display, the refrigeration appliance does not get cold even though the controls and the interior lighting are working.	Demo mode has been activated. <ul style="list-style-type: none"> <li>■ Touch <i>OK</i>.</li> </ul> <p>Miele will appear initially in the display, followed by the start screen.</p> <ul style="list-style-type: none"> <li>■ Touch <i>OK</i>.</li> <li>■ In Settings mode ⚙️, use the &lt; or &gt; sensor to scroll to the ■ symbol.</li> <li>■ Touch <i>OK</i>.</li> </ul> <p>After Demo mode ■ has been switched off, the refrigeration appliance shuts down and must be switched on again.</p>

## Problem solving guide

Message	Possible cause and remedy
<p> is lit up in the display and the refrigeration appliance cannot be used.</p>	<p>The Cleaning mode function is still switched on.</p> <ul style="list-style-type: none"> <li>■ Touch the <i>OK</i> sensor on the control panel to switch off Cleaning mode.</li> </ul> <p> will appear in the display.</p> <ul style="list-style-type: none"> <li>■ Touch <i>OK</i>.</li> </ul> <p>When Cleaning mode  is switched off, the dot in the upper corner of the display goes out.</p> <ul style="list-style-type: none"> <li>■ Use the &lt; or &gt; sensor to scroll to the  symbol and touch <i>OK</i>.</li> </ul> <p>The refrigeration appliance will start cooling again.</p>
<p>Nothing is visible in the display. The display is dark.</p>	<p>Sabbath mode  is switched on: the interior lighting is switched off and the refrigeration appliance is cooling down.</p> <ul style="list-style-type: none"> <li>■ Touch <i>OK</i>.</li> </ul> <p> will appear in the display.</p> <ul style="list-style-type: none"> <li>■ Touch <i>OK</i>.</li> </ul> <p>When the Sabbath mode function  is switched on, a dot appears in the upper corner of the display •.</p> <ul style="list-style-type: none"> <li>■ Touch <i>OK</i>.</li> </ul> <p>When the Sabbath mode function  is switched off, the dot in the upper corner of the display goes out.</p>
<p>The  symbol is lit up in the display and the refrigeration appliance cannot be used.</p>	<p>The lock function has been activated.</p> <ul style="list-style-type: none"> <li>■ Unlock the refrigeration appliance temporarily or switch the lock function off completely.</li> </ul>
<p>The  symbol lights up in the start display and a buzzer also sounds.</p>	<p>The charcoal filters change indicator  in the start display reminds you that the charcoal filters need to be changed.</p> <ul style="list-style-type: none"> <li>■ Replace the charcoal filters in the holder (see “Cleaning and care – Replacing the charcoal filters (optional accessories)”) and confirm that the charcoal filters have been replaced by touching the <i>OK</i> sensor.</li> </ul> <p>The  symbol will go out in the start display.</p>





## Problem solving guide

Message	Possible cause and remedy
<p> lights up in the display; an alarm will also sound and the interior lighting will flash.</p>	<p>The <b>door alarm</b> has been activated.</p> <ul style="list-style-type: none"> <li>■ Tap <i>OK</i>.</li> </ul> <p>The alarm stops, the  symbol goes out and the interior lighting lights up constantly again.</p> <ul style="list-style-type: none"> <li>■ Close the appliance door.</li> </ul>
<p> lights up in the display and a fault code <b>F</b> with numbers may appear. An alarm also sounds.</p>	<p>There is a fault.</p> <ul style="list-style-type: none"> <li>■ Switch the alarm off by touching <i>OK</i>.</li> <li>■ Contact Customer Service.</li> </ul> <p>To report the fault, you need the fault code and also the model identifier and serial number of your refrigeration appliance. You can access this information  in the display:</p> <ul style="list-style-type: none"> <li>■ Tap <i>OK</i>.</li> </ul> <p>The appliance data required will be shown in the display.</p> <ul style="list-style-type: none"> <li>■ Tap <i>OK</i>.</li> <li>■ To switch off the refrigeration appliance, use the &lt; or &gt; sensor to scroll to the  symbol.</li> <li>■ To exit the information display, use the &lt; or &gt; sensor to scroll to the  symbol.</li> <li>■ Tap <i>OK</i>.</li> </ul> <p>There is an appliance fault: this display always has priority over any settings which have just been selected.</p> <p>An appliance fault has priority over any current door and/or temperature alarms in the display.</p>

## Interior lighting

 Risk of electric shock due to exposed, live electrical components!  
 When removing the lighting cover, there is a risk of coming into contact with live electrical components.  
 Do not remove the lighting cover. The LED lighting must only be repaired or replaced by a qualified technician.

 Danger of injury from LED lighting.  
 This lighting corresponds to risk group RG 2. If the cover is defective, there is a risk of eye injury.  
 Do not look from a close range directly into the lighting with optical instruments (e.g. magnifying glass or similar).

Problem	Possible cause and remedy
<b>The interior lighting is not working.</b>	The refrigeration appliance is not switched on. ■ Switch the appliance on.
	Sabbath mode  is switched on: the display is black and the refrigeration appliance is cooling. ■ Touch <i>OK</i> .  will appear in the display. ■ Touch <i>OK</i> .
	When the Sabbath mode function  is switched on, a dot appears in the upper corner of the display •. ■ Touch <i>OK</i> .
	When the Sabbath mode function  is switched off, the dot in the upper corner of the display goes out. To avoid overheating, the interior lighting switches itself off automatically after approx. 15 minutes if the door is left open. If this is not the case, there is a fault. ■ Call Miele.
<b>The interior lighting is pulsating.</b>	This is not a fault. The door alarm has been activated.

## Noises

The refrigeration appliance is producing various noises during operation.  
 If the cooling demand is low, the refrigeration appliance will conserve energy but operate for longer. The volume will be lower.  
 Food will be chilled faster if the cooling demand is high.  
 The volume will be higher.

## Problem solving guide

---

Normal noises	What is causing the noises?
<b>Hissing</b>	Refrigerant is being injected into the cooling circuit.
<b>Bubbling, gurgling, splashing</b>	Refrigerant is circulating through the pipes.
<b>Humming</b>	The refrigeration appliance is cooling.
<b>Clicking</b>	The thermostat is switching the compressor on or off.
<b>Humming, whirring</b>	The fan is running. The automatic door opener (depending on the model) is opening or closing the appliance door.
<b>Cracking</b>	Material in the refrigeration appliance is expanding.
<b>Rattling</b>	Valves or flaps are active.
<b>Buzzing (refrigeration appliances with water container)</b>	Water is being pumped out of the water container.
<b>Slurping (refrigeration appliances with soft-close mechanism)</b>	The appliance door with soft-close mechanism is being opened or closed.
Please bear in mind that a certain amount of noise is unavoidable (from the compressor and the refrigerant circulating through the cooling circuit).	

## Problem solving guide

Noises	Possible cause and remedy
<b>Vibrating, rattling, clinking</b>	The refrigeration appliance is uneven. Use a level to check and adjust the alignment of the refrigeration appliance. The refrigeration appliance is aligned by raising or lowering the adjustable feet (depending on the model) underneath it. <b>For built-in appliances:</b> For niches of 140 cm or more: place the stabilising rods supplied underneath the appliance base.
	The refrigeration appliance is touching another appliance or piece of furniture. Move it away.
	Drawers, baskets or shelves are jiggling or are stuck. Check all removable items and refit them correctly.
	Bottles or containers are touching. Separate bottles or containers slightly.
	The transport cable clips (depending on the model) are hanging loose at the back of the appliance. Remove the transport cable clips.

# Service

---

You can find information on how to remedy faults yourself at [www.miele.com.au/support/customer-assistance](http://www.miele.com.au/support/customer-assistance) or [www.miele.co.nz/support/customer-assistance](http://www.miele.co.nz/support/customer-assistance) and about Miele spare parts at [www.miele.com.au/service](http://www.miele.com.au/service) or [www.miele.co.nz/service](http://www.miele.co.nz/service).

## Contact in case of fault

In the event of a fault which you cannot remedy yourself, please contact Miele.

You can book a Miele customer service call-out online at [www.miele.com.au/service](http://www.miele.com.au/service) or [www.miele.co.nz/service](http://www.miele.co.nz/service).

Contact information for Miele can be found at the end of this booklet.

Please quote the model and serial number of your appliance when contacting Miele. Both of these can be found on the data plate inside the refrigeration appliance or, depending on the model, in the settings mode under information **i**.

## Warranty

The manufacturer's warranty for this appliance is 2 years.

For further information, please refer to your warranty booklet.

**Miele Australia Pty. Ltd.**

ACN 005 635 398, ABN 96 005 635 398

Miele Head Office Melbourne:

Level 4, 141 Camberwell Road

Hawthorn East, VIC 3123

**1300 464 353 (1300 4 MIELE)**

**info@miele.com.au**

**www.miele.com.au**

**Hong Kong, China**

Miele (Hong Kong) Ltd.

41/F - 4101, Manhattan Place

23 Wang Tai Road, Kowloon Bay

Hong Kong

Tel.: (852) 2610 1025

Fax: (852) 3579 1404

E-mail: customerservices@miele.com.hk

Website: www.miele.hk

**India**

Miele India Pvt. Ltd.

1st Floor, Copia Corporate Suites,

Commercial Plot 9,

Mathura Road, Jasola,

New Delhi - 110025

E-mail: customercare@miele.in

Website: www.miele.in

**Malaysia**

Miele Sdn Bhd

Suite 12-2, Level 12

Menara Sapura Kencana Petroleum

Solaris Dutamas No. 1, Jalan Dutamas 1

50480 Kuala Lumpur, Malaysia

Phone: +603-6209-0288

Fax: +603-6205-3768

**Miele Global Headquarters Germany**

Miele & Cie. KG, Carl-Miele-Straße 29, 33332 Gütersloh, Federal Republic of Germany

**Miele New Zealand Ltd.**

IRD 98 463 631

Head Office:

8 College Hill

Freemans Bay, Auckland 1011

**0800 464 353 (0800 4 MIELE)**

**customercare@miele.co.nz**

**www.miele.co.nz**

**Singapore**

Miele Pte. Ltd.

29 Media Circle

#11-04 ALICE@Mediapolis

Singapore 138565

Tel: +65 6735 1191

Fax: +65 6735 1161

E-mail: info@miele.com.sg

Internet: www.miele.sg

**South Africa**

Miele (Pty) Ltd

63 Peter Place, Bryanston 2194

P.O. Box 69434, Bryanston 2021

Tel.: (011) 875 9000

Fax: (011) 875 9035

E-mail: info@miele.co.za

Internet: www.miele.co.za

**Thailand**

Miele Appliances Ltd.

BHIRAJ TOWER at EmQuartier

43rd Floor Unit 4301-4303

689 Sukhumvit Road

North Klongton Sub-District

Vadhana District

Bangkok 10110, Thailand

KS 4383 ED edt/cs

en - AU, NZ

M.-Nr. 12 124 620 / 02 / 002