

Operating and installation Instructions Washing machine



It is **essential** to read these operating instructions before installing and using the appliance. This prevents both personal injury and damage to the appliance.

Contents

Caring for the environment	4	Cleaning and care	35
Warning and Safety instructions ..	5	Cleaning the external casing and fascia panel	35
Operating the washing machine ...	11	Cleaning the detergent dispenser drawer	35
Control panel.....	11	Cleaning the drum, suds container and drainage system.....	37
How the control panel works.....	12	Cleaning the sealing ring.....	37
Using for the first time	14	Cleaning the filters in the water inlet.....	38
Networking.....	15	Problem solving guide	39
Requirements for networking	15	The programme does not start	39
Washing environmentally and economically	18	Programme cancellations and fault messages	39
1. Preparing the laundry	19	Symbols in the time display	40
2. Loading the washing machine ..	20	Fault indicator light at the end of a programme.....	41
3. Selecting the programme and settings	21	An unsatisfactory wash result.....	42
4. Adding detergent	23	General problems with the washing machine.....	42
5. Starting the programme - the end of the programme	25	The door will not open.....	44
◆ Delay start/SmartStart	26	Opening the door in the event of a blocked drain outlet and/or power cut.....	45
Programme chart	28	After sales service	47
Extras	31	Contact in case of fault	47
Pre-wash.....	31	Optional accessories	47
Water+ 	31	Maintenance	47
Rinse+ 	31	Installation	48
Special features in the programme sequence	32	Front view.....	48
Spinning.....	32	Rear view	49
Anti-crease	32	Installation locations	50
Changing the programme sequence	33	Installation notes.....	50
Changing a programme	33	Transporting the washing machine to its installation site	51
Cancelling a programme.....	33	Installation surface	52
Adding or removing laundry	33	Removing the transit bars.....	52
Detergent	34	Fitting the transit bars	54
The correct detergent	34	Aligning the washing machine.....	55
		Installing under a continuous worktop	55
		Fixing bracket for plinth	56

Water connection	58
Drainage.....	59
Drain pump	59
Electrical connection	60
Technical data	61
Programmable functions	62
Choosing and selecting programmable functions	62
Editing and saving the programmable function	63
Exiting the programming level	63
<i>P11</i> Buzzer duration.....	63
<i>P12</i> Buzzer	63
<i>P13</i> Keypad tone	64
<i>P14</i> PIN code	64
<i>P22</i> Control panel switch-off status	64
<i>P24</i> Memory.....	65
<i>P26</i> Longer pre-wash Cottons.....	65
<i>P28</i> Gentle action.....	65
<i>P29</i> Temperature reduction.....	65
<i>P32</i> Maximum rinse level.....	65
<i>P33</i> Suds cooling.....	66
<i>P34</i> Anti-crease.....	66
<i>P49</i> Low water pressure	66
<i>P62</i> Backlight brightness dimmed ..	66
<i>P63</i> Welcome tone	67
<i>P90</i> Operating hours	67
<i>P00</i> Factory default setting	67
Networking.....	67
Resetting the network configuration.....	67
<i>P97</i> Remote control.....	68
<i>P98</i> SmartGrid (only functional in selected countries).....	68
<i>P99</i> RemoteUpdate.....	69
Copyright and licences for the communication module.....	70

Caring for the environment

Disposal of the packing material

The transport and protective packaging has been selected from materials which are environmentally friendly for disposal, and can normally be recycled.

Recycling the packaging reduces the use of raw materials in the manufacturing process and also reduces the amount of waste in landfill sites.

Ensure that any plastic wrappings, bags etc. are disposed of safely and kept out of the reach of babies and young children. Danger of suffocation.

Only for Australia: Note for installer: Expanded polystyrene (EPS) packaging included. Please retain and dispose of EPS packaging responsibly. For further information, please contact Miele.

Note for installer:

Expanded polystyrene (EPS) packaging included. Please retain and dispose of EPS packaging responsibly. For further information, please contact Miele.

Disposing of your old appliance

Electrical and electronic appliances often contain valuable materials. They also contain specific materials, compounds and components, which were essential for their correct function and safety. These could be hazardous to human health and to the environment if disposed of with your domestic waste or if handled incorrectly. Please do not, therefore, dispose of your old appliance with your household waste.



Please dispose of it at your local community waste collection / recycling centre for electrical and electronic appliances. You are also responsible for deleting any personal data that may be stored on the appliance prior to disposal. Please ensure that your old appliance poses no risk to children while being stored prior to disposal.

Warning and Safety instructions

This washing machine complies with all current local and national safety requirements. However, inappropriate use can lead to personal injury and damage to property.

Read the operating instructions carefully before using the washing machine. They contain important information on safety, installation, use and maintenance of the appliance. This prevents both personal injury and damage to the washing machine.

In accordance with standard IEC 60335-1, Miele expressly and strongly advises that you read and follow the instructions in "Installation", as well as in the "Warning and Safety instructions".

Miele cannot be held liable for injury or damage caused by non-compliance with these instructions.

Keep these operating instructions in a safe place and pass them on to any future owner.

When instructing other people how to use the washing machine, they must be made aware of these Warning and Safety instructions.

Correct application

- ▶ The washing machine is only suitable for washing fabrics with a care label stating that they are suitable for machine washing. Any other applications may be dangerous. The manufacturer cannot be held liable for damage resulting from incorrect or improper use or operation of the machine.
- ▶ This washing machine must be used as described in the operating instructions and must be checked on a regular basis to make sure it is functioning correctly. Maintenance must be carried out when necessary.
- ▶ The washing machine is not suitable for outdoor use.
- ▶ This washing machine is intended for commercial use in small businesses, care homes, sports clubs, hospitals and other similar commercial environments. This machine may also be operated by lay persons in public areas such as laundrettes, communal laundry rooms or similar commercial environment.
- ▶ This washing machine is also intended for use in domestic households and in similar residential environments, for example by customers in hotels, motels, bed and breakfasts and other related establishments.

Warning and Safety instructions

- ▶ This washing machine is not intended for use by persons (including children) with reduced physical, sensory or mental capabilities, or lack of experience and knowledge, unless they have been given supervision or instruction concerning its use by a person responsible for their safety.
- ▶ Young children must not be allowed to use this appliance.
- ▶ Older children may only use the appliance when its operation has been clearly explained to them and they are able to use it safely. They must be able to understand and recognise the possible dangers caused by incorrect operation.
- ▶ Cleaning or maintenance on the washing machine may only be carried out by older children under the supervision of an adult.
- ▶ Always supervise any children in the vicinity of the washing machine. Never allow children to play with the washing machine.

Technical safety

- ▶ Before installing and operating the washing machine, check it for any visible exterior damage. Do not set up or use a damaged washing machine.
- ▶ The electrical safety of this washing machine can only be guaranteed when continuity is complete between it and an effective earthing system which complies with current local and national safety regulations.
It is most important that this basic safety requirement is present and regularly tested and, when there is any doubt, the on-site wiring system should be inspected by a qualified electrician.
Miele cannot be held liable for the consequences of an inadequate earthing system (e.g. electric shock).
- ▶ Unauthorised repairs could result in unforeseen dangers for the user, for which the manufacturer cannot accept liability. Repairs must only be carried out by a Miele authorised service technician, otherwise any subsequent damage will not be covered by the warranty.
- ▶ Do not make any alterations to the machine, unless authorised to do so by Miele.
- ▶ In the event of a fault or for cleaning purposes, the washing machine must be isolated from the electricity supply. It is only completely isolated if:

Warning and Safety instructions

- it is switched off at the wall socket and the plug is withdrawn, or
- the mains fuse is disconnected, or
- it is switched off at the mains circuit breaker.

For further information see “Installation - Electrical connection”.

▶ If the electrical connection cable is faulty, it must only be replaced by a Miele authorised service technician to protect the user from danger.

▶ The washing machine must be connected to the water supply using the new hose set supplied with the appliance. Old hose sets should not be re-used. Check the hose regularly for signs of wear. Replace it in good time to avoid the risk of leaks and water damage.

▶ Faulty components must only be replaced by genuine Miele original spare parts. Miele can only guarantee the safety standards of the machine when Miele replacement parts are used.

▶ Do not connect the machine to the mains electricity supply by a multi-socket adapter, extension lead or similar. These do not guarantee the required safety of the machine (fire hazard due to the risk of overheating).

▶ The machine must not be installed and operated in mobile locations (e.g. on a ship).

▶ Please observe the instructions in “Installation” and “Technical data”.

▶ If the washing machine is equipped with a mains plug, it must be easily accessible after installation so that the machine can be disconnected from the electricity supply if necessary.

▶ If the appliance is hard wired, an on-site dual circuit breaker must be accessible at all times in order to disconnect the washing machine from the mains supply. The means of disconnection must be incorporated in the fixed wiring in accordance with the wiring rules.

▶ Temporary or permanent operation with a self-sufficient or non-mains synchronous energy supply system (e.g. isolated networks, back-up systems) is possible. A requirement for the operation is that the energy supply system complies with all current local and national requirements that apply to stand-alone, solar and/or battery systems. The protective measures provided in the building installation and in this Miele product must also be assured in their function and operation in isolated operation or in non-mains synchronous operation, or replaced with equivalent measures in the installation.

Warning and Safety instructions

▶ The manufacturer's warranty will be invalidated if the appliance is not repaired by a Miele approved service technician.

Correct use

▶ The maximum load is 8.0 kg (dry laundry). See the “Programme chart” for the maximum recommended loads for individual programmes.

▶ Do not install your washing machine in a room where there is a risk of frost. Frozen hoses may burst or split, and the reliability of the electronic control unit may be impaired at temperatures below freezing point.

▶ Before using the machine for the first time, check that the transit bars at the rear of the washing machine have been removed (see “Installation and connection – Removing the transit bars”). During spinning, transit bars which are still in place can cause damage to both the machine and adjacent furniture or appliances.

▶ Turn off the tap if the machine is to be left for any length of time (e.g. while on holiday), especially if there is no floor drain (gully) in the immediate vicinity.

▶ If the ventilation openings are in the base of the washing machine, ensure that they are not obstructed by deep-pile carpet or similar.

▶ Danger of flooding! If hooking the drain hose into a laundry washtub, check that the water can drain away fast enough to prevent the laundry tub from overflowing. Secure the drain hose against slipping. The force of the water flowing out of the hose can dislodge it.

▶ Make sure that no foreign objects (e.g. nails, pins, coins, paper clips) find their way into the machine with the laundry. Foreign objects can damage components of the machine (e.g. suds container, drum). Damaged components can, in turn, result in damage to the laundry.

▶ If the correct amount of detergent is dispensed, the machine should not need to be descaled. If, however, you do wish to descale it, only use special non-corrosive descaling agents and strictly observe the instructions on the packaging. Special descaling agent is available from your Miele dealer or from Miele. Strictly observe the instructions for the packaging.

Warning and Safety instructions

- ▶ For textiles that have been treated with solvent-based cleaning agents, always check whether they can be washed in a washing machine. To check whether this is possible, refer to safety notes, information concerning the product's environmental compatibility, and other information.
- ▶ Never use solvent-based detergents, e.g. those containing benzene, in this washing machine. This may result in damage to component parts and create toxic fumes. Risk of fire and explosion!
- ▶ Gasoline, petroleum, kerosene, paraffin, or any easily flammable liquid must not be stored or used near the washing machine. Risk of fire and explosion!
- ▶ Only use dyes suitable for use in a washing machine. Always observe the manufacturer's instructions carefully.
- ▶ Dye removers contain sulphur compounds which can cause damage such as corrosion. Dye removers must not be used in the washing machine.
- ▶ Avoid contact between stainless steel surfaces (front, lid, casing) and liquid detergents or disinfecting agents which contain chlorine or sodium hypochlorite. These agents can cause corrosion on stainless steel. Aggressive vapours containing chlorine can also be corrosive. Do not store open containers of these agents near the machine.
- ▶ Do not use a high-pressure cleaner or water jet to clean the washing machine.
- ▶ It is particularly important to observe the manufacturer's instructions when using a combination of cleaning agents and special application products. Products must only be used for applications approved by the manufacturer to avoid any material damage or the occurrence of strong chemical reactions.
- ▶ If detergent has come into contact with the eyes, rinse out immediately with plenty of lukewarm water. If detergent has accidentally been ingested, seek medical advice immediately. People with damaged or sensitive skin should avoid contact with detergent.
- ▶ When adding or removing laundry during the main wash, your skin may come into contact with detergent, particularly if the detergent is dispensed externally. Take care when placing your hands inside the drum. If suds have come into contact with the skin, rinse off immediately with lukewarm water.

Warning and Safety instructions

Accessories







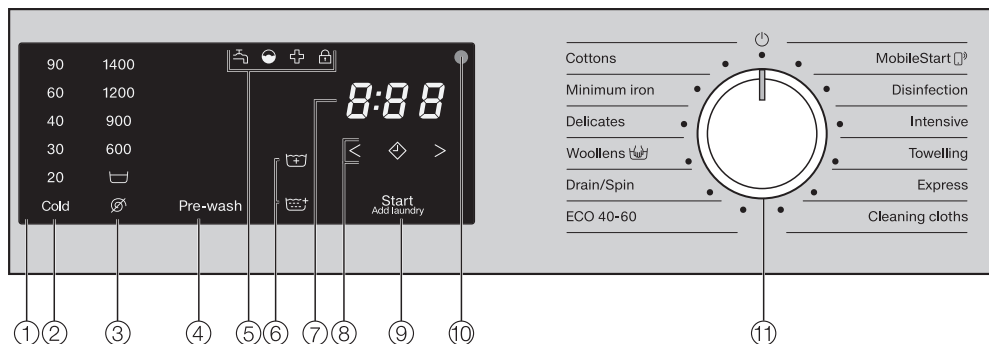

- ▶ Only use original Miele accessories. If other parts are used, warranty, performance and product liability claims will be invalidated.
- ▶ Miele tumble dryers and Miele washing machines can be installed as a washer-dryer stack. This requires a Miele washer-dryer stacking kit which can be purchased separately. Please ensure that the washer-dryer stacking kit is suitable for your Miele tumble dryer and your Miele washing machine.
- ▶ If installing the machine on a Miele plinth (available as an optional accessory), please make sure you order the correct one for this washing machine.
- ▶ Miele will guarantee to supply functional spare parts for a minimum of 10 years and up to 15 years following the discontinuation of your washing machine.

Miele cannot be held liable for damage caused by non-compliance with these Warning and Safety instructions.

Operating the washing machine

Control panel



- ① **Control panel**
- ② **Temperature sensors**
For selecting the temperature
- ③ **Spin speed sensors**
For selecting the spin speed
- ④ **Pre-wash sensor**
For selecting the *Pre-wash Extra*
- ⑤ **Indicator lights**    
light up when necessary
- ⑥ **Extras sensors**
For selecting the *Water+*  and *Rinse+*  Extras
- ⑦ **Time display**
For the programme running time
- ⑧ **<   > Sensors**
For the Delay start function
- ⑨ ***Start/Add laundry* sensor**
starts the selected programme and allows you to add laundry
- ⑩ **Optical interface**
For service technicians
- ⑪ **Programme selector**
For selecting programmes and for switching off the appliance
The washing machine is switched on when you select a programme and switched off by turning the programme selector to the  position.

Operating the washing machine

How the control panel works

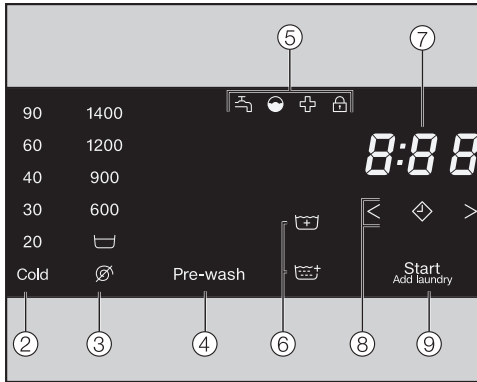

The ②, ③, ④, ⑥, ⑧ and ⑨ sensors react to fingertip contact. Selection is possible as long as the respective sensor is illuminated.

If a sensor is brightly lit, this means it is currently selected.

If a sensor is dimly lit, this means it can be selected.

② and ③ sensors for temperature and spin speed

After selecting a wash programme with the programme selector, the recommended temperature (in °C) and spin speed (in rpm) light up brightly.

Selectable temperatures and spin speeds light up dimly.

④ Pre-wash sensor

You can supplement certain wash programmes with the *Pre-wash Extra*.

If an Extra can be selected for the wash programme, the sensor for the Extra lights up dimly.

⑤ Indicator lights

- lights up if there are faults with the water inlet and drainage.
- lights up if excess detergent was used.
- lights up as a reminder about hygiene information.
- lights up if the door of the washing machine is locked

⑥ Extras sensors

You can select the *Water+* and *Rinse+* Extras to augment some wash programmes.

If an Extra can be selected for the wash programme, the sensor for the Extra lights up dimly.

⑦ Time display

After the programme has started, the programme duration will appear in the display in hours and minutes.

When Delay start is being used, the programme duration will appear after the Delay start time has elapsed.

⑧ < ◊ > sensors

- ◊
After touching the ◊ sensor, a later start time for the programme (Delay start) can be selected. Once selected, ◊ lights up brightly.

- < >
The duration of the Delay start period is selected by touching the < or > sensor.

The Delay start time selected will appear in the time display.

After the programme has started, the Delay start time will begin to count down.

Once the Delay start time has elapsed, the programme begins. The estimated programme duration appears in the time display.

Start/Add laundry ⑨ sensor

- The programme can be started as soon as the sensor is flashing on and off. Touching the *Start/Add laundry* sensor starts the selected programme. The sensor lights up constantly.
- Once the programme has been started, touching the *Start/Add laundry* sensor allows you to add laundry.

Using for the first time

 Damage resulting from incorrect installation and connection. Installing and connecting the washing machine incorrectly will cause serious damage to property. Please observe the instructions in “Installation and connection”.

Removing the protective foil and stickers

■ Remove:

- the protective foil from the door
- any stickers from the front and the lid

Please do not remove any labels (e.g. the data plate) which are visible when you open the door.

Emptying the drum

A swivel elbow for the drain hose and/or assembly material may be stored in the drum.

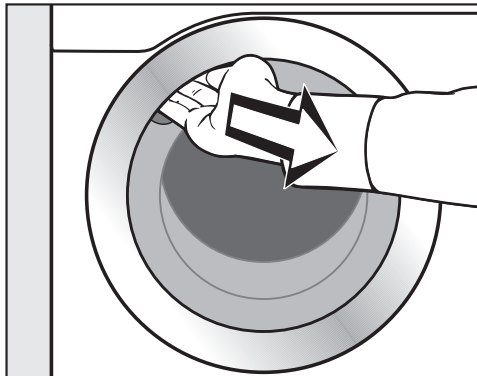

- Pull open the door.
- Remove the swivel elbow and assembly material.
- Shut the door with a gentle swing.

This washing machine has undergone a complete functional test at the factory. Some residual water will therefore remain in the drum from this process.

Networking

Your washing machine is equipped with an integrated Wi-Fi module. The Wi-Fi module makes it possible to connect to your home network and to use the Miele App on a mobile device.

Once your washing machine has been connected via Wi-Fi, the connection is automatically re-established every time it is switched on.

Make sure that your Wi-Fi network signal is strong enough in the place where you intend to install your washing machine.

Connecting your washing machine to your Wi-Fi network will increase energy consumption, even when the washing machine is switched off.

Smart Extras via the Miele App*

Networking via the Miele App gives you access to numerous Smart Extras, including:

- Accessing status information.
- Using additional helpful functions.
- Keep your washing machine up to date with the latest Miele developments via software updates.

You can find more detailed information about Smart Extras on the Miele website, in the Apple App Store® or in the Google Play Store™.

*This is a separate digital offer from Miele & Cie. KG. The range of functions can vary depending on the model and the country. Acceptance of the General Terms and Conditions and Privacy Policy for Miele digital products and services in the Miele App is required. Miele reserves the right to change or discontinue the digital offers at any time.

Miele App

You can download the Miele App from the Apple App Store® or the Google Play Store™ free of charge (only functional in selected countries).



Requirements for networking

Note the following requirements for networking:

1. A home network is available at the installation site.
Have the Wi-Fi password ready.
2. The Miele App is available on a mobile device.
3. You have a user account in the Miele App.

Using for the first time

Setting up Miele@home

There are 2 ways of connecting:

1. Via the Miele App (default)
2. Via WPS

Signing on via the Miele App

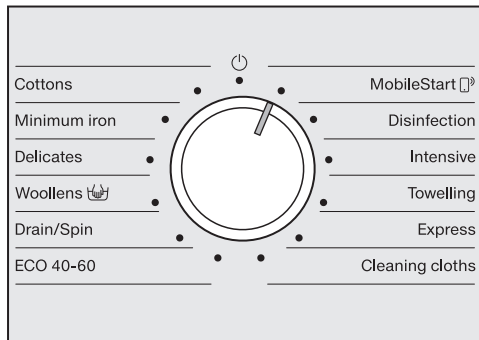



- Turn the programme selector to the *MobileStart*  programme.

APP appears in the time display and the timeout starts to count down from 10 minutes. The Miele App will guide you through the remaining steps.

When you have successfully connected, *Con* will appear in the time display.

Signing on via WPS

- Turn the programme selector to the *MobileStart*  programme.
- Touch the  sensor repeatedly until *WPS* appears in the time display.

The timeout time then starts to count down from 2 minutes in the time display.

- Activate the WPS function on your router within 2 minutes.

When you have successfully connected, *Con* will appear in the time display.

Useful tip: If the connection has not been set up when the timeout has finished counting down, repeat the process.

Running the first wash programme

For safety reasons, spinning is not possible until the machine has been prepared for use for the first time. To activate the spinning function, you must run a wash programme without laundry and without detergent.

Using detergent could result in an excessive build-up of foam.

- Turn on the tap.
- Turn the programme selector to *Cottons*.

The washing machine is switched on.

- Touch the *Start/Add laundry* sensor.

If the *Start/Add laundry* sensor is not touched within 60 seconds, the display goes dark and the *Start/Add laundry* sensor control no longer flashes green. To switch the display back on, touch the  sensor control. You then have another 60 seconds in which to start the wash programme.

The wash programme will start.

After 10 minutes, the indicators dim and the *Start/Add laundry* sensor starts flashing.

Opening the door at the end of the programme

The door remains locked during the Anti-crease phase. The control panel lights up for the first 10 minutes. The control panel then goes out and the *Start/Add laundry* sensor flashes.

- Turn the programme selector to the  position.

The door will unlock.

Useful tip: After the Anti-crease phase, the washing machine will have switched off and the door unlocked automatically. The control panel is completely dark.

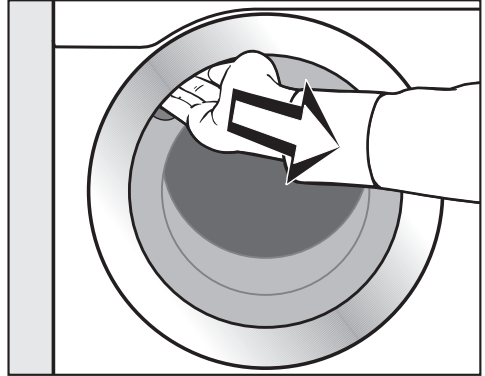

- Reach under the door grip and pull the door open.

Useful tip: For safety reasons, close the door when the machine is not in use. Otherwise there is a danger of objects being placed inadvertently in the drum. If these remain unnoticed and were washed in the next load, they could damage the laundry. An open door is also a danger to pets and children.

The appliance is now ready for use.

Washing environmentally and economically

Energy and water consumption

- Use the maximum load size for the current programme. The energy and water consumption will then be the lowest in relation to the size of the load.
- Programmes that are more efficient with regard to energy and water consumption generally have a longer programme running time. By extending the programme running time, the wash temperature that is actually reached can be reduced while still providing the same wash results.

For example, the *ECO 40-60* programme has a longer running time than the *Cottons 40°C* or *60°C* programme. The *ECO 40-60* programme, however, is more efficient in terms of energy and water consumption.

- Use the *Express* programme for small, lightly soiled loads.
- Modern detergents make it possible to wash at lower temperatures (e.g. 20°C). Using lower temperature settings will save energy.
- To maintain the hygiene of the machine, carry out a hot wash (above 60°C) at regular intervals. The  indicator will come on to remind you to carry out a hot wash.

Detergent consumption

- Do not exceed the amounts of detergent recommended by the manufacturer on the packaging.
- Adjust the dosage to the degree of soiling of the laundry.
- Reduce the amount of detergent with smaller loads (e.g. reduce the amount of detergent by $\frac{1}{3}$ when washing a half load).

Information about subsequent tumble drying

The spin speed selected affects the residual moisture in the laundry and the sound emissions of the washing machine.

The higher the spin speed, the lower the residual moisture in the laundry. However, the sound emissions of the washing machine will increase.

Select the highest possible spin speed for the wash programme to save energy in the subsequent tumble dryer cycle.

1. Preparing the laundry

Emptying all pockets



- Empty all pockets.

⚠ Damage due to foreign objects.

Foreign objects (e.g. nails, coins, paper clips etc.) can cause damage to garments and to components in the machine.

Check the laundry before washing and remove any foreign objects.

Sorting the laundry

- Sort the laundry by colour and by care label. Most garments have a textile care label in the collar or side seam.

Pre-treating stains

- Clean badly soiled areas and stains on the textiles before washing. Spillages should be carefully dabbed off using a soft, colourfast cloth.

⚠ Damage due to solvent-based cleaning agents.

Cleaning agents containing benzene, stain remover, etc., can damage plastic parts.

When pre-treating garments, make sure that any plastic parts (e.g. buttons) do not come into contact with cleaning agent.

⚠ Risk of explosion due to solvent-based cleaning agents.

If solvent-based cleaning agents are used, an explosive mixture can form. Never use solvent-based cleaning agents in the washing machine.

General tips

- Do not wash any items in this machine which are specified by the manufacturer as **not washable** on the care label (☒ symbol).
- Curtains: Remove lead weights first or place in a laundry bag.
- Remove or sew in any loose underwiring in bras or shirt collar stiffeners.
- Turn garments inside out, if recommended by the manufacturer.
- Close any zips and Velcro fasteners before washing.
- Fasten duvet covers and pillow cases to prevent small items from being rolled up inside them.
- Please refer to the Programme chart for more tips.

2. Loading the washing machine

Opening the door

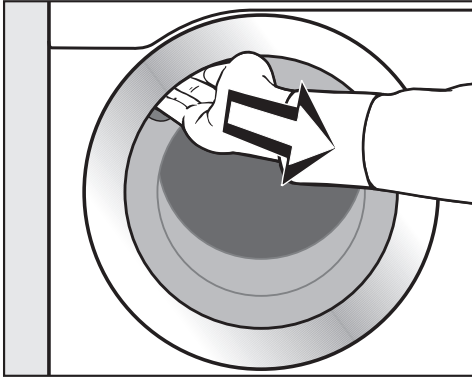

- Reach under the door grip and pull the door open.

Check the drum for pets or foreign objects before loading it with laundry.

- Unfold the laundry and load loosely in the drum.

Mixing both large and small items gives better wash results and helps distribute the load evenly during spinning.

The most efficient use of energy and water is achieved when a full load is washed. However, do not overload as this reduces cleaning efficiency and causes creasing.

Closing the door

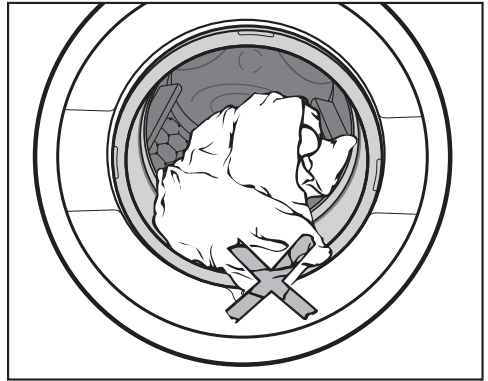

- Make sure that no items are caught between the door and the seal.

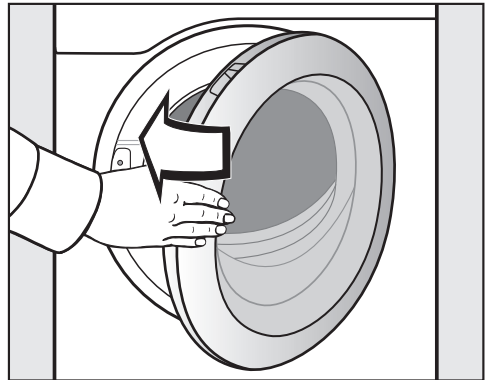

- Shut the door with a gentle swing.

3. Selecting the programme and settings

1. Selecting wash programmes using the programme selector

The washing machine is switched on by turning the programme selector to a wash programme.

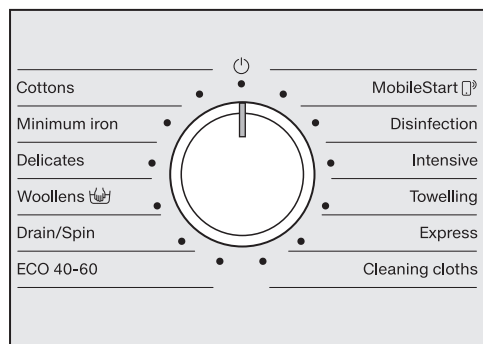



- Turn the programme selector to the required programme.

The likely wash time is shown in the time display and the preset temperature and spin speed light up on the control panel.

2. Selecting programmes using the MobileStart programme selector position and Miele App

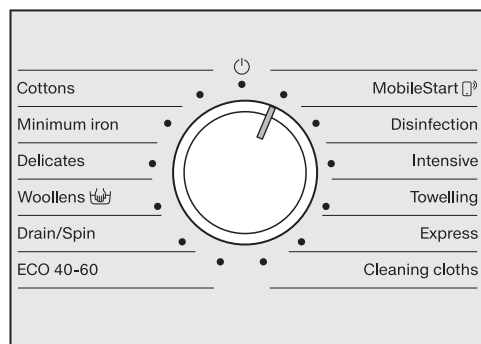
Useful tip: To use MobileStart , the washing machine must be logged on to the Wi-Fi network and *Remote control* must be switched on.



- Turn the programme selector to the MobileStart  position.

On appears in the time display.



Once the programme has started, the washing machine can be operated with the Miele App.

You must touch the *Start/Add laundry* sensor to enable operation via the Miele App.

3. Selecting the programme and settings

Selecting the temperature and spin speed

The wash programme's pre-set temperature and spin speed light up brightly. The choice of temperatures and spin speeds selectable for the wash programme light up dimly.

90	1400
60	1200
40	900
30	600
20	
Cold	

- Touch the sensor for the temperature you want.

The sensor lights up brightly.

- Touch the sensor for the spin speed you want.

The sensor lights up brightly.

Selecting Extras

If an Extra can be selected for the wash programme, the sensor for the Extra lights up dimly.

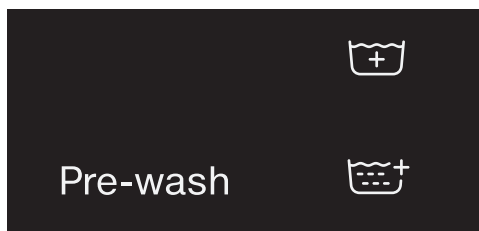

- Touch the sensor for the Extra you want.

The sensor lights up brightly.

You can select multiple Extras for a wash programme.

Please refer to “Extras” for more information.

4. Adding detergent

Detergent dispenser drawer

Any detergent suitable for automatic front loading washing machines can be used with this appliance.

Detergent dispensing

Please follow the detergent manufacturer's instructions in relation to dosage.

Adding too much detergent will lead to excessive foaming.
Avoid adding excess detergent.

The amount to dispense will depend on:

- the amount of laundry
- the degree of soiling of the laundry
- the water hardness

Water hardness range	Hardness in mmol/l	German scale °dH
soft (I)	0-1.5	0-8.4
medium (II)	1.5-2.5	8.4-14
hard (III)	above 2.5	above 14

Check with your local water supplier if you do not know the water hardness in your area.

Adding detergent

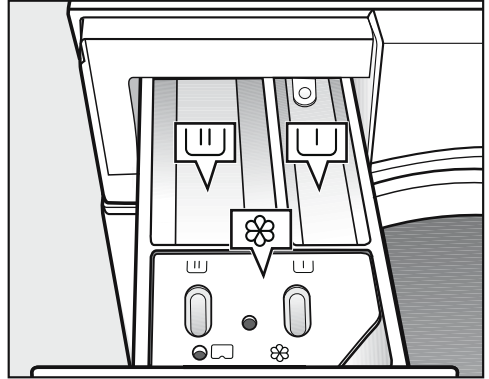



- Pull out the detergent dispenser drawer and add detergent to the compartments.

- U Detergent for the pre-wash (divide the total recommended amount as follows: $\frac{1}{3}$ to compartment U and $\frac{2}{3}$ to compartment U)
- U Detergent for the main wash
- ⊗ Fabric softener or liquid starch

4. Adding detergent

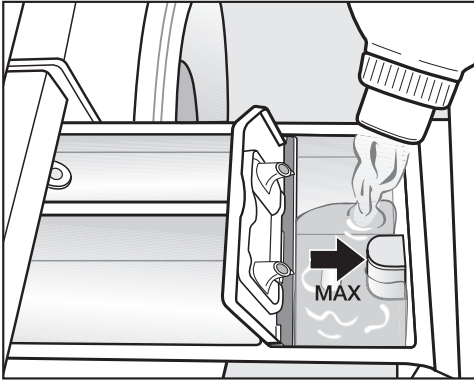
Automatic dispensing of fabric softener or liquid starch



- Add the fabric softener or the liquid starch to the  compartment. **Do not exceed the maximum level mark.**

This will be automatically dispensed in the final rinse. At the end of the wash programme a small amount of water remains in the  compartment.

Useful tip: If starching frequently, thoroughly clean the dispenser compartment, especially the siphon tube, regularly.

Dye removers and dyes

 Damage due to colour run/dye removers.

Colour run and dye removers can cause corrosion in the washing machine.

Do not use colour run or dye removers in this washing machine.

Only use dyes suitable for use in a washing machine. The manufacturer's instructions on the packaging must be observed.

5. Starting the programme - the end of the programme

Starting a programme

Automatic safety lock

The washing machine has an automatic safety lock. The washing machine can only be started within 60 seconds of the last operational step on the control panel.

If the 60 seconds are exceeded, or if the door is opened and re-closed, the display goes dark and the *Start/Add laundry* sensor control no longer flashes green. To switch the display back on, touch the  sensor control.

You then have another 60 seconds in which to start the wash programme.

- Touch the flashing *Start/Add laundry* sensor.

The door will lock and the programme will start.

- When the  symbol lights up constantly, the door is locked until the end of the programme.

If a Delay start time has been selected, this counts down in the time display. At the end of the Delay start period or immediately after the programme has started, the programme running time will appear in the time display.

Energy savings

After 10 minutes, the indicators will dim. The *Start/Add laundry* sensor flashes slowly.

You can reactivate the indicators:

- Touch the *Start/Add laundry* sensor (this does not have any effect on a programme that is running).

At the end of the programme

The door remains locked during the Anti-crease phase. The control panel lights up for the first 10 minutes. The control panel then goes out and the *Start/Add laundry* sensor flashes.

- Turn the programme selector to the  position.

The door will unlock.

Useful tip: After the Anti-crease phase, the door will unlock automatically.

- Pull open the door.
- Remove the laundry.

Items left in the drum could discolour other items in the next wash or become discoloured themselves. Remove all items from the drum.

- Check the door sealing ring for any foreign objects.

Useful tip: For safety reasons, close the door when the machine is not in use. Otherwise there is a danger of objects being placed inadvertently in the drum. If these remain unnoticed and were washed in the next load, they could damage the laundry. An open door is also a danger to pets and children.

Useful tip: Leave the detergent dispenser drawer slightly open to allow it to dry.

Delay start/SmartStart

Selecting Delay start

Delay start cannot be selected in the *Drain/Spin* programme.

- Select the required programme.
- Touch the  sensor.

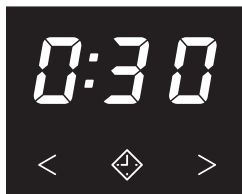

The  sensor lights up brightly.

- Touch the < or > sensor repeatedly until the required Delay start time appears in the time display.
- For less than 10 hours, the Delay start time changes in increments of 30 minutes.
- For more than 10 hours, the Delay start time changes in increments of 1 hour.

Starting Delay start

- Touch the flashing *Start/Add laundry* sensor.

The Delay start process starts and counts down in the time display.

The  symbol will flash.

Altering Delay start

- Touch the *Start/Add laundry* sensor until the door unlocks and the  symbol goes out.

The Delay start process stops.

- Touch the < or > sensor repeatedly until the required Delay start time appears in the time display.
- Touch the flashing *Start/Add laundry* sensor.

Cancelling Delay start

- Touch the *Start/Add laundry* sensor until the door unlocks and the  symbol goes out.

The Delay start process stops.

- Touch the brightly lit  sensor.

The Delay start time is deleted. The programme duration appears in the time display.

- Touch the flashing *Start/Add laundry* sensor in order to start the wash programme.

SmartStart (only functional in selected countries)

You can set your washing machine to start automatically based on an external signal within a certain time period.

This function is active when the *P98* SmartGrid programmable function is switched on.

The timeframe can be defined between 30 minutes and 24 hours. The washing machine will then start within the time period specified by you when it receives an external signal. If it has not received an external signal by the latest start time set, the washing machine will start automatically.

Setting the timeframe











If the *P98* SmartGrid programmable function is activated, the function of the  sensor changes. The time display no longer shows the Delay start period, and instead shows the time period in which your washing machine can be started automatically (see “Programmable functions - *P98* SmartGrid”).

The procedure for setting this is the same as for setting the time for Delay start.









- Touch the  sensor.
- Set the time period you want using the < or > sensor.
- Touch the *Start/Add laundry* sensor.

€€r appears in the time display.

Programme chart

Cottons		Cold to 90°C	Max. load 8.0 kg
Items	Cotton, linen, and mixed fibre textiles		
Tip	<ul style="list-style-type: none"> - Select the temperature according to the instructions on the care label, the detergent, the type of soiling and the hygiene requirements. - Use the 20°C programme for lightly soiled cotton garments. 		
1400 rpm	Extras: Pre-wash  , Water+  , Rinse+ 	Rinse cycles: 2	
Minimum iron		Cold to 60°C	Max. load 4,0 kg
Items	Synthetic, mixed fibre and easy-care cotton		
Tip	- Reduce the final spin speed for fabrics which crease easily.		
1200 rpm	Extras: Pre-wash  , Water+  , Rinse+ 	Rinse cycles: 2	
Delicates		Cold to 40°C	Max. load 3,0 kg
Items	Delicate garments made from synthetic fibre, mixed fibre, rayon and viscose.		
Tip	- Deselect the final spin speed for fabrics which crease easily.		
600 rpm	Extras: Pre-wash  , Water+  , Rinse+ 	Rinse cycles: 2	
Woollens		Cold to 30°C	Max. load 3,0 kg
Items	Machine-washable woollens and woollen blends		
Tip	- Use detergent formulated for woollens.		
1200 rpm		Rinse cycles: 2	
Drain/Spin		Max. load 8.0 kg	
Tip	<ul style="list-style-type: none"> - Select the Rinse+ Extra for an additional rinse cycle. - Make sure you select the appropriate spin speed. - Drain only: Set spin speed to . 		
1400 rpm	Extras: Rinse+ 		

Programme chart

ECO 40-60		Max. load 8.0 kg
Items	Normally soiled cotton garments	
Tip	<ul style="list-style-type: none"> - A laundry load consisting of mixed cottons that are intended for washing at 40°C or 60°C can be washed in the same wash cycle. - This programme is the most efficient in terms of energy and water consumption for washing cottons. - Using the ECO 40-60 programme is recommended for a mixed cotton load. It is the programme used in the energy consumption tests according to AS/NZS 2040. 	
1400 rpm	Extras: Pre-wash 	Rinse cycles: 2
MobileStart 		
Tip	The Miele App is used to select programmes and operate the appliance.	
Disinfection		60°C
Max. load 5.5 kg		
Items	Cotton or mixed fibre textiles, sorted by colour, provided they are suitable for disinfection	
Tip	<ul style="list-style-type: none"> - Chemo-thermal disinfection with a 30-minute holding time at 60°C. - Use specialist detergents. 	
1400 rpm	Extras: Pre-wash  , Rinse+ 	Rinse cycles: 2
Intensive		40°C to 90°C
Max. load 8.0 kg		
Items	Heavily soiled workwear made from cotton, linen, and mixed fibres	
Tip	- A particularly good wash and rinse result is achieved by a high water level.	
1400 rpm	Extras: Pre-wash  , Rinse+ 	Rinse cycles: 2
Bedding and towelling		40°C to 60°C
Max. load 6,0 kg		
Items	Towels and bathrobes made from terrycloth	
Tip	- Use a colour detergent for dark textiles.	
1400 rpm	Extras: Pre-wash  , Water+  , Rinse+ 	Rinse cycles: 2

Programme chart

Express		Cold to 40°C	Max. load 3,5 kg
Items	Cotton garments that have hardly been worn or are only very lightly soiled.		
1400 rpm			Rinse cycles: 1
Mops & cloths		40°C to 90°C	Max. load 4,0 kg
Items	Mops or cloths made from cotton, mixed fibre or microfibre		
Tip	<ul style="list-style-type: none"> - The programme is designed for washing mops and cleaning cloths. - Use specialist detergents. - A pre-spin and a pre-rinse cycle are carried out before the main wash. 		
1400 rpm			Rinse cycles: 2

You can supplement the wash programmes with Extras.

Selecting Extras

Extras are selected and deselected using the sensors on the control panel.

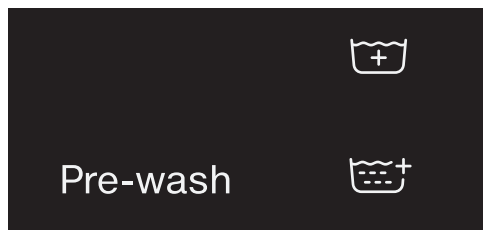

- Touch the sensor for the Extra you want.

The relevant sensor will light up brightly.

Not all Extras can be selected with every programme.

If the sensor lighting is switched off, this means the Extra cannot be selected.

The Extra cannot be activated by touch.

Pre-wash

A pre-wash can be added for heavily soiled laundry. Coarse soiling is loosened and removed before the main wash.

Water+

The water level in the main wash and the rinse cycles is increased.

Rinse+

An extra rinse can be activated to achieve a better wash result.

Special features in the programme sequence

Spinning

Final spin speed

When a programme is selected, the maximum spin speed for this wash programme is shown in the display. You can reduce the final spin speed. However, you cannot select a final spin speed higher than that shown in the chart.

Interim spin

There is a spin cycle after the main wash and between the rinses. A reduction in the final spin speed will also reduce the interim spin speed accordingly.

Deselecting the interim spin and the final spin

- Touch the  sensor.

After the last rinse cycle, the water will be pumped away and the anti-crease phase will switch on.

Omitting the final spin (Rinse hold)

- Touch the  sensor (Rinse hold).

The laundry is not spun after the final rinse and remains in the rinse water. This helps prevent creasing if the laundry is not going to be removed from the drum immediately after the end of the programme.

Starting the final spin after Rinse hold.

The sensor for the optimum spin speed lights up on the control panel. You can change the spin speed. The *Start/Add laundry* sensor flashes slowly.

- Touch the flashing *Start/Add laundry* sensor.

The final spin is carried out.

Ending the programme after Rinse hold

- Reduce the spin speed to .
- Touch the *Start/Add laundry* sensor.

The suds will be pumped away. The programme is finished.

Anti-crease

At the end of the programme, the drum continues to turn at intervals for up to 30 minutes to help prevent creasing. The door can be opened at any time during the anti-crease phase.

There is no anti-crease phase at the end of some programmes.

Changing the programme sequence

Changing a programme

After the start of a programme, it is no longer possible to select a different programme.

You will need to cancel the current programme before you can select a different one.

If the programme selector is moved, **-0-** will appear in the display. Turn the programme selector back to the original position.

If the washing machine is switched off during active programme operation, the standby function does not switch the washing machine off completely after 15 minutes. Safety functions continue to be active because there may still be water inside the drum.

Cancelling a programme

You can cancel a programme at any time after it has started.

- Turn the programme selector to the  position.
- Turn the programme selector to any position.

Rotating bars **L** ... **C** ... **C** or **-0-** are shown in the time display.

The water is pumped away and the door lock is released.

Selecting a new programme

- Turn the programme selector to the required programme.
- Check that there is still detergent in the dispenser drawer. Add more detergent if necessary.
- Touch the *Start/Add laundry* sensor.

Adding or removing laundry

Laundry can be added or removed at any time, provided that the  symbol is not illuminated in the control panel.

- Touch the *Start/Add laundry* sensor.

Rotating bars **L** ... **C** ... **C** are shown in the time display.

If the word *Add* appears in the time display, the door can be opened.

- Open the door.
- Add or remove laundry.
- Close the door.
- Follow the process for starting a programme again.

The wash programme will continue.

Detergent

The correct detergent

Any detergent suitable for automatic front loading washing machines can be used with this appliance. Follow the manufacturer's instructions and dosage recommendations on the packaging.

The recommendations apply to the temperature ranges given in the Programme chart.

	Universal	Colour	Delicates and woollens	Special
	Detergent			
Cottons	✓	✓	–	–
Minimum iron	–	✓	–	–
Delicates	–	–	✓	–
Woollens 	–	–	✓	✓
ECO 40-60	✓	✓	–	–
Mops & cloths	–	–	–	✓
Intensive	✓	–	–	✓
Bedding and towelling	✓	✓ ¹	–	–
Express	–	✓ ¹	–	–
Mops & cloths	–	–	–	✓

- ✓ Recommended
- not recommended
- ¹ Liquid detergent

⚠ Risk of electric shock!
Only ever perform cleaning and maintenance work when the appliance is disconnected from the power.
Disconnect the washing machine from the mains electricity supply.

Cleaning the external casing and fascia panel

⚠ Damage caused by cleaning agents.
Solvent based cleaning agents, abrasive cleaners, glass cleaners or multi-purpose cleaning agents can cause damage to plastic surfaces and other parts.
Do not use any of these cleaning agents.

⚠ Risk of damage due to ingress of water.
The pressure of a water jet can cause water to get into the washing machine, resulting in damage to components.
Do not spray the washing machine with a water jet.

- Clean the casing and control panel with a mild cleaning agent or soap and water and dry both with a soft cloth.
- The drum and other stainless steel parts can be cleaned using a suitable stainless steel cleaning agent.

Cleaning the detergent dispenser drawer

Washing at low temperatures and the use of liquid detergent can lead to a build-up of mould and bacteria in the detergent dispenser drawer.

- For hygiene reasons, clean the entire drawer at regular intervals.

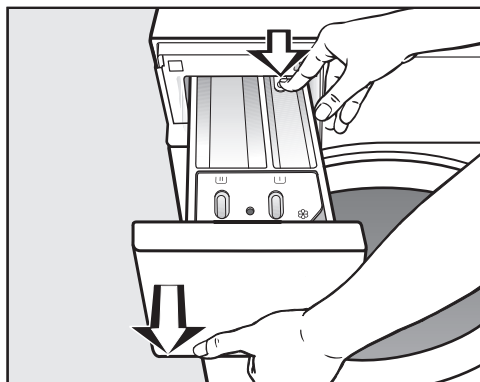

- Pull out the detergent dispenser drawer until a resistance is felt. Press down the release button and at the same time pull the drawer right out of the machine.
- Clean the detergent dispenser drawer with warm water.

Cleaning and care

Cleaning the siphon and the channel

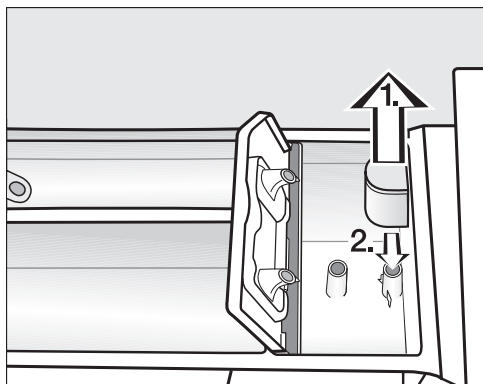

- Pull the siphon out of the  compartment. Clean the siphon under warm running water. Clean the siphon tube in the same way.
- Refit the siphon.

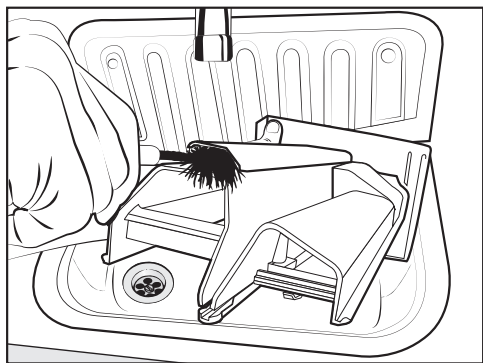

- Clean the fabric softener channel using a brush and warm water.

Cleaning the detergent dispenser drawer housing

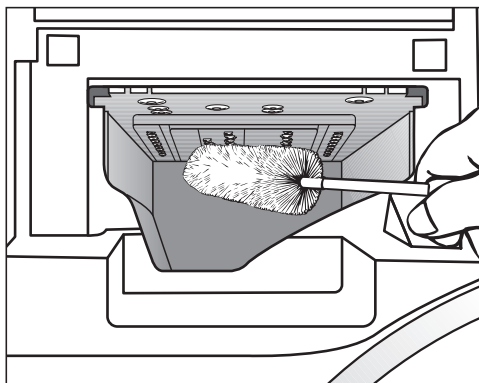

- Use a bottle brush to remove detergent residues and limescale from the jets inside the detergent dispenser drawer housing.
- Replace the detergent dispenser drawer.

Useful tip: Leave the detergent dispenser drawer slightly open to allow it to dry.

Cleaning the drum, suds container and drainage system

By using wash programmes of 60°C or more on a regular basis and using a multi-purpose detergent, you can avoid the build-up of bacteria in the washing machine.

The drum, suds container, and drainage system can be cleaned whenever the  indicator light lights up or when required.

Optimum results can be achieved by using a machine cleaner. Alternatively, a multi-purpose powder detergent can be used.

- Start the *Cottons 90°C* programme without a load.
- Dispense the machine cleaner or multi-purpose detergent directly into the drum.
- Do **not** load any laundry. The drum must be empty for the cleaning process.
- At the end of the programme, check the inner drum and remove any coarse residues.

Cleaning the sealing ring

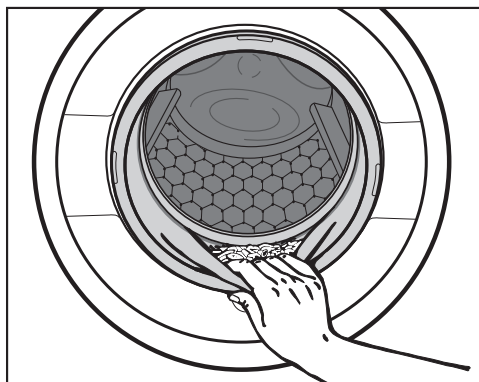

- Check the fold in the sealing ring for foreign objects.
- Clean the sealing ring and the inner fold of the sealing ring with a damp cloth.

Useful tip: For safety reasons, close the door when the machine is not in use. Otherwise there is a danger of objects being placed inadvertently in the drum. If these remain unnoticed and were washed in the next load, they could damage the laundry. An open door is also a danger to pets and children.

Cleaning and care

Cleaning the filters in the water inlet

The washing machine has filters to protect the water inlet valves. Check these filters about every 6 months. Perform this check more often if there are frequent interruptions to the external water supply.

Cleaning the filter in the inlet hose

- First turn off the tap.
- Unscrew the inlet hose.
- Remove the rubber seal from the recess.
- Using combination or pointed pliers, take hold of the plastic filter bar and remove it.
- Clean the plastic filter.
- Reassemble in reverse order.

Make sure there is no water leaking from the threaded union.
Tighten the threaded union.

Cleaning the filter in the inlet valve

- Using pliers, carefully loosen the ribbed plastic nut on the inlet valve and unscrew.

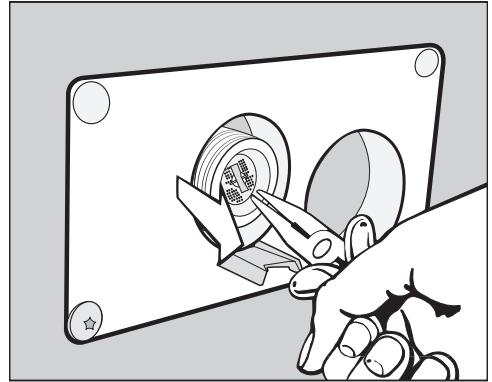

- Use pointed pliers to withdraw the plastic filter by the bar.
- Clean the filter.
- Reassemble in reverse order.

The filters protect the water inlet valve.
Replace the filters after cleaning.

With the help of the following guide, minor faults in the performance of the appliance, some of which may result from incorrect operation, can be remedied without contacting Miele. This will save you time and money because you will not need a service call.

Please note, however, that a call-out charge will be applied to unnecessary service visits where the problem could have been rectified as described in these operating instructions.



The programme does not start

Problem	Possible cause and remedy
The control panel remains dark.	The washing machine has an automatic safety lock. The washing machine can only be started within 60 seconds of the last operational step. <ul style="list-style-type: none"> ■ Touch the  sensor control. You then have another 60 seconds in which to start the wash programme.
	There is no power to the machine. <ul style="list-style-type: none"> ■ Check whether the mains plug is plugged in and switched on. ■ Check whether the circuit breaker has tripped.
	The washing machine has switched off automatically to save energy. <ul style="list-style-type: none"> ■ Switch the washing machine back on by turning the programme selector.
F and 34 alternately appear in the time display.	The door is not closed properly. The door lock could not engage. <ul style="list-style-type: none"> ■ Close the door again. ■ Restart the programme. If the fault message appears again, contact Miele.

Programme cancellations and fault messages

Problem	Possible cause and remedy
The fault indicator light  lights up, F and 10 appear alternately in the time display and the buzzer sounds.	The water inlet is blocked or restricted. <ul style="list-style-type: none"> ■ Check whether the tap is turned on properly. ■ Check whether the inlet hose is kinked. ■ Check whether there is sufficient water pressure.
	The filter in the water inlet is blocked. <ul style="list-style-type: none"> ■ Clean the filter.



Problem solving guide

Problem	Possible cause and remedy
The fault indicator light  lights up. <i>F</i> and <i>//</i> alternately appear in the time display and the buzzer sounds.	<p>The water outlet is blocked or restricted.</p> <p>The drain hose has been fixed too high.</p> <ul style="list-style-type: none"> ■ Clean the drain filter and the drain pump. ■ The maximum drain height is 1 m.
<i>F</i> and <i>XXX</i> alternately appear in the time display and the buzzer sounds.	<p>There is a fault.</p> <ul style="list-style-type: none"> ■ Disconnect the washing machine from the mains electricity supply, either by switching it off at the wall socket and withdrawing the plug, or by disconnecting it at the circuit breaker. ■ Wait at least 2 minutes before reconnecting the washing machine to the electricity supply. ■ Then switch the washing machine back on. ■ Restart the programme. <p>If the fault message appears again, contact Miele.</p>
The fault indicator light  lights up, <i>F</i> and <i>138</i> appear alternately in the time display and the buzzer sounds.	<p>The water protection system has reacted.</p> <ul style="list-style-type: none"> ■ Turn off the tap. ■ Call Miele.



Symbols in the time display

Message	Possible cause and remedy
<i>-0-</i> is lit up in the time display.	<p>The programme selector was moved to a different position after the programme had started.</p> <ul style="list-style-type: none"> ■ Turn the programme selector back to the original position.
<i>UP</i> lights up when the washing machine is switched on.	<p>An update is available for the washing machine. See “Programmable functions – <i>P99</i> RemoteUpdate” for more information.</p>
<i>℄r</i> lights up briefly in the time display when a programme is selected.	<p><i>℄r</i> indicates that the washing machine is networked.</p>
<i>OFF</i> lights up when the <i>MobileStart</i>  programme is selected.	<p>The remote control function is switched off.</p> <ul style="list-style-type: none"> ■ Activate the remote control programmable function <i>P97</i> to operate the washing machine via the App.

Problem solving guide

Message	Possible cause and remedy
On lights up when the MobileStart  programme is selected.	The washing machine is networked and can be operated via the App.
no lights up when the MobileStart  programme is selected.	Miele@home is not set up. <ul style="list-style-type: none"> ■ Network the washing machine (see “Before using for the first time – Setting up Miele@home”).
On lights up when the washing machine is switched on.	Miele@home is not available. <ul style="list-style-type: none"> ■ Switch off the washing machine. ■ Then switch the washing machine on again. ■ If On appears again, contact Miele. <p>The washing machine can continue to be used.</p> <ul style="list-style-type: none"> ■ Touch the illuminated  sensor.

Fault indicator light at the end of a programme

Problem	Possible cause and remedy
The indicator light  lights up.	A wash programme using a temperature above 60°C has not been run for a long time. <ul style="list-style-type: none"> ■ In order to prevent bacteria and unpleasant odours building up in the machine, run the <i>Cottons 90°C</i> programme using the Miele washing machine cleaner or a universal powder detergent.
The indicator light  lights up.	Excessive foam has built up during washing. <ul style="list-style-type: none"> ■ Use less detergent next time and follow the manufacturer's instructions on dosage given on the packaging.

Problem solving guide

An unsatisfactory wash result

Problem	Possible cause and remedy
Liquid detergent does not give the required result.	Liquid detergents usually contain no bleaching agents. They do not remove fruit, coffee and tea stains. <ul style="list-style-type: none">■ Use a general purpose powder detergent containing a bleaching agent.■ Add stain removers to compartment  of the detergent dispenser drawer and fill liquid detergent into a dispenser ball.■ Never put stain removers and liquid detergent together in the dispenser drawer.
White residues which look like powder detergent are seen on dark textiles after washing.	The detergent contains compounds (zeolites) to aid water softening which are not soluble in water. These have ended up on the laundry. <ul style="list-style-type: none">■ Try to brush off the residues with a soft brush once the laundry is dry.■ Wash dark textiles using a detergent which contains no zeolites. Liquid detergents do not usually contain zeolites.
Textiles that were very greasy are not properly clean.	<ul style="list-style-type: none">■ Select a programme with pre-wash. Use liquid detergent for the pre-wash.■ Continue to use universal powder detergent for the main wash.
	The use of heavy-duty detergent is recommended in the main wash for very heavily soiled work clothing. Please seek advice from the detergent manufacturer.
Grey, greasy particles cling to washed laundry.	Insufficient amounts of detergent were used. The laundry was heavily soiled with grease (oils, ointments). <ul style="list-style-type: none">■ Use more detergent or liquid detergent with this type of soiled laundry.■ Before washing the next load, run a 60°C programme with liquid detergent but without a load.

General problems with the washing machine

Problem	Possible cause and remedy
The machine shakes during the spin cycle.	The machine feet are not level. <ul style="list-style-type: none">■ Level the machine and adjust the feet correctly.

Problem solving guide

Problem	Possible cause and remedy
The pump makes strange noises.	This is not a fault. Slurping noises occur at the end of the pump sequence as a normal part of operation.
Large amounts of detergent residue remain in the detergent dispenser drawer.	<p>The water pressure is too low.</p> <ul style="list-style-type: none"> ■ Clean the filters in the water inlet. <p>Powder detergent used in conjunction with water softeners tends to become sticky.</p> <ul style="list-style-type: none"> ■ Clean the detergent dispenser drawer and, in the future, add washing powder to the dispensing drawer first, and then add the water softener.
Fabric softener is not completely dispensed or too much water remains in the  compartment.	<p>The siphon tube is not correctly positioned or clogged.</p> <ul style="list-style-type: none"> ■ Clean the siphon (see “Cleaning and care - Cleaning the detergent dispenser drawer”).
The washing machine did not spin the laundry as usual. The laundry is still wet.	<p>The machine detected an imbalance during the final spin and reduced the spin speed automatically.</p> <ul style="list-style-type: none"> ■ Include both large and small items in the load as this will give better distribution.

Problem solving guide

The door will not open

Problem	Possible cause and remedy
The door cannot be pulled open during a programme.	<p>The door is locked during the washing process.</p> <ul style="list-style-type: none">■ Touch the <i>Start/Add laundry</i> sensor to cancel the programme. <p>The programme is cancelled, the door unlocks and you can pull it open.</p> <hr/> <p>There is still water in the drum and the machine is unable to drain.</p> <ul style="list-style-type: none">■ Clean the drain filter and drain pump as described in “Problem solving guide – Opening the door in the event of a blocked drain outlet and/or power failure”.
After the programme is cancelled, flashing bars <i>l j j...l j j...l j j...</i> appear in the time display.	<p>For safety reasons, the door cannot be opened if the suds temperature is higher than 55°C.</p> <ul style="list-style-type: none">■ Wait until the temperature in the drum has decreased and the bars have stopped flashing in the display.
<i>F</i> and <i>35</i> alternately appear in the time display.	<p>The door lock has jammed.</p> <ul style="list-style-type: none">■ Call Miele.

Opening the door in the event of a blocked drain outlet and/or power cut

⚠ Risk of electric shock!
Only ever perform cleaning and maintenance work when the appliance is disconnected from the power.
Disconnect the washing machine from the mains electricity supply.

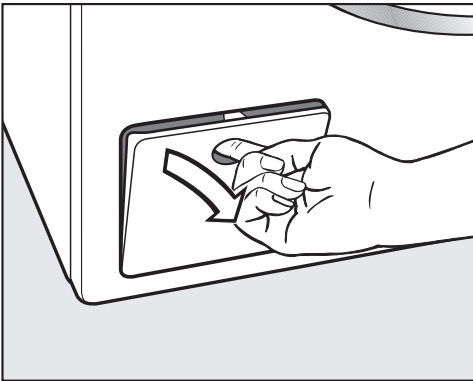

- Open the access panel to the drain system.

Blocked drain outlet

If the drain outlet is blocked, a larger quantity of water (max. 30 l) can remain in the washing machine.

⚠ Risk of scalding due to hot suds.
Escaping suds will be hot if laundry has been washed at high temperatures shortly before.
Drain the suds carefully.

Emptying the drum

....in machines with a drain pump

- Place a suitable container under the access flap.

Remove the drain filter, though not completely.

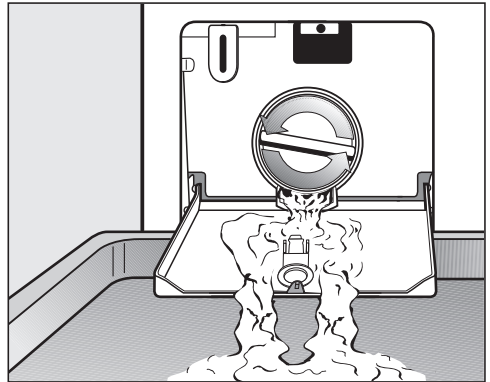

- Slowly and carefully unscrew the filter to let the water out. Be careful not to release too much water at once. If the flow of water is too strong, some water can seep into the washing machine base and activate the water protection float switch. This will prevent the washing machine from functioning.
- Tighten the drain filter back up again if you need to interrupt the flow of water.

Problem solving guide

Cleaning the drain filter

Once the flow of water ceases:

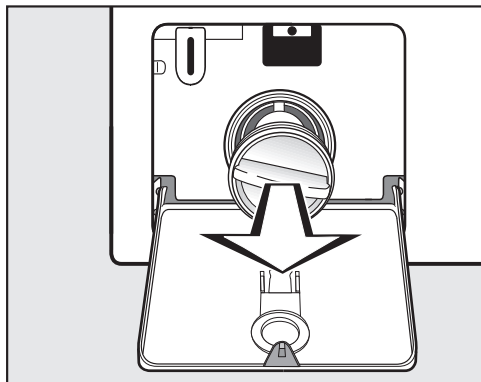

- Remove the drain filter completely.
- Clean the drain filter thoroughly.

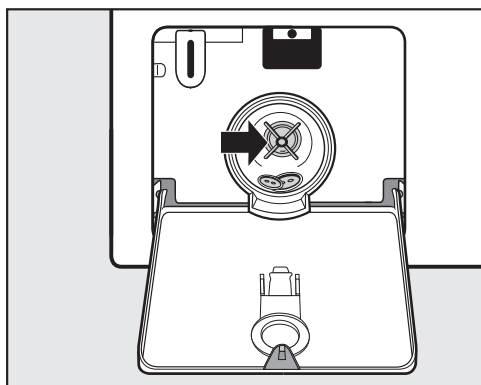

- Check the drain pump impellers to make sure they can rotate freely.
- Remove any foreign objects (e.g., buttons, coins etc.) and clean the interior.
- Put the drain filter back in place and secure it.

 Risk of water damage.

Make sure the drain filter is securely tightened. Otherwise there is a risk of water leakage during use.

Replace the drain filter correctly and tighten it securely.

Opening the door

 Danger of injury due to rotating drum!

Reaching into a moving drum is extremely dangerous. Danger of injury!

Always make sure that the drum is stationary before reaching in to remove laundry.

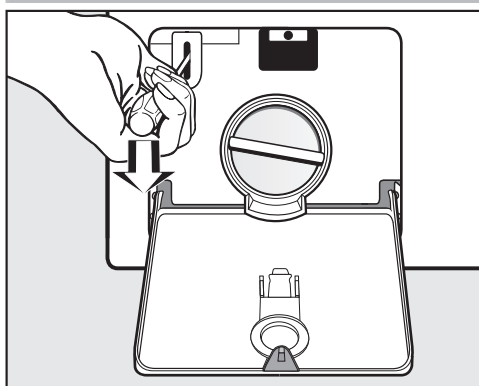

- Use a screwdriver to unlock the door of the washing machine as shown.
- Pull open the door.

Contact in case of fault

In the event of any faults which you cannot remedy yourself, please contact Miele.

Contact information for Miele can be found at the end of this booklet.

Please quote the model and serial number of your appliance when contacting Miele. This information can be found on the data plate.

The data plate is found above the porthole glass when the washing machine door is opened:

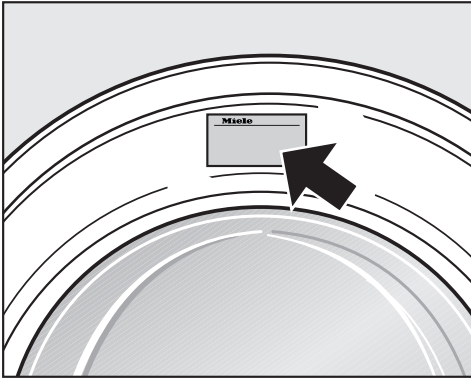

Optional accessories

Optional spare parts and accessories for this washing machine are available from Miele.

Maintenance

Preventive maintenance supports fault-free operation and prevents unnecessary repairs.

Miele recommends regular maintenance by Miele Customer Service.

Installation

Front view

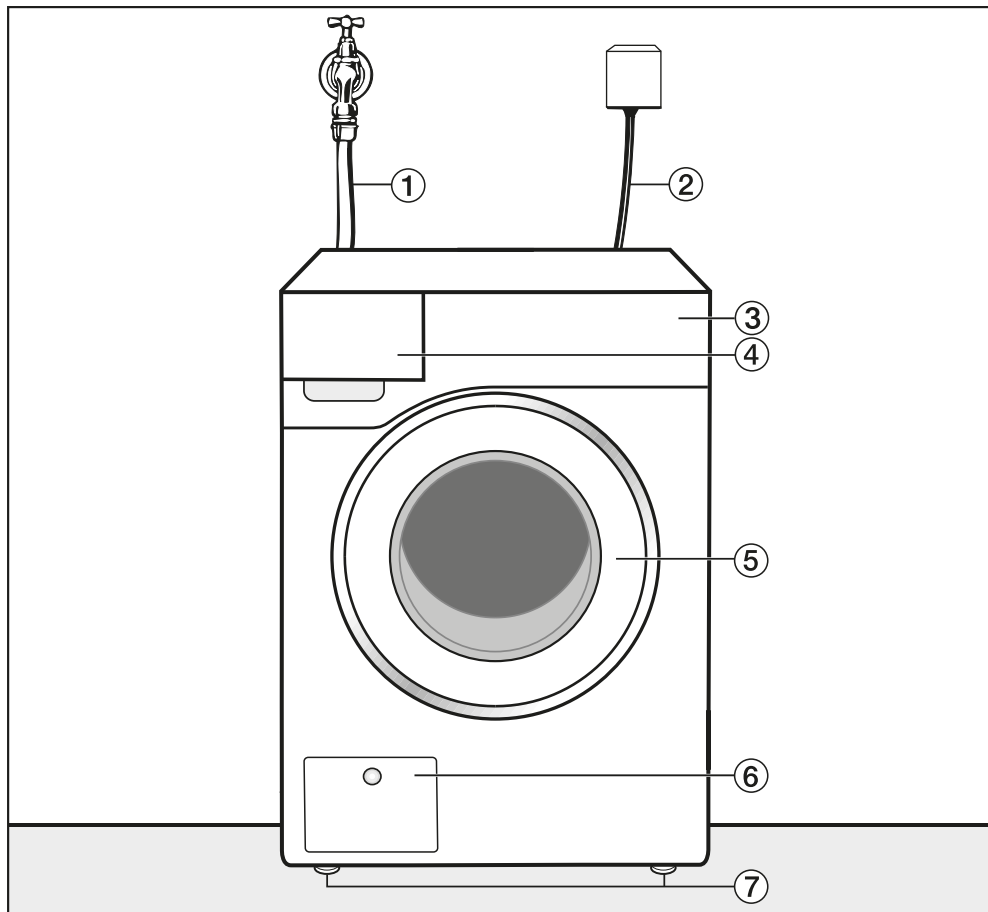

① Cold water inlet hose

② Electrical connection

③ Control panel

④ Detergent dispenser drawer

⑤ Door

⑥ Flap for the drain filter and the drain pump

⑦ Height-adjustable feet

Rear view

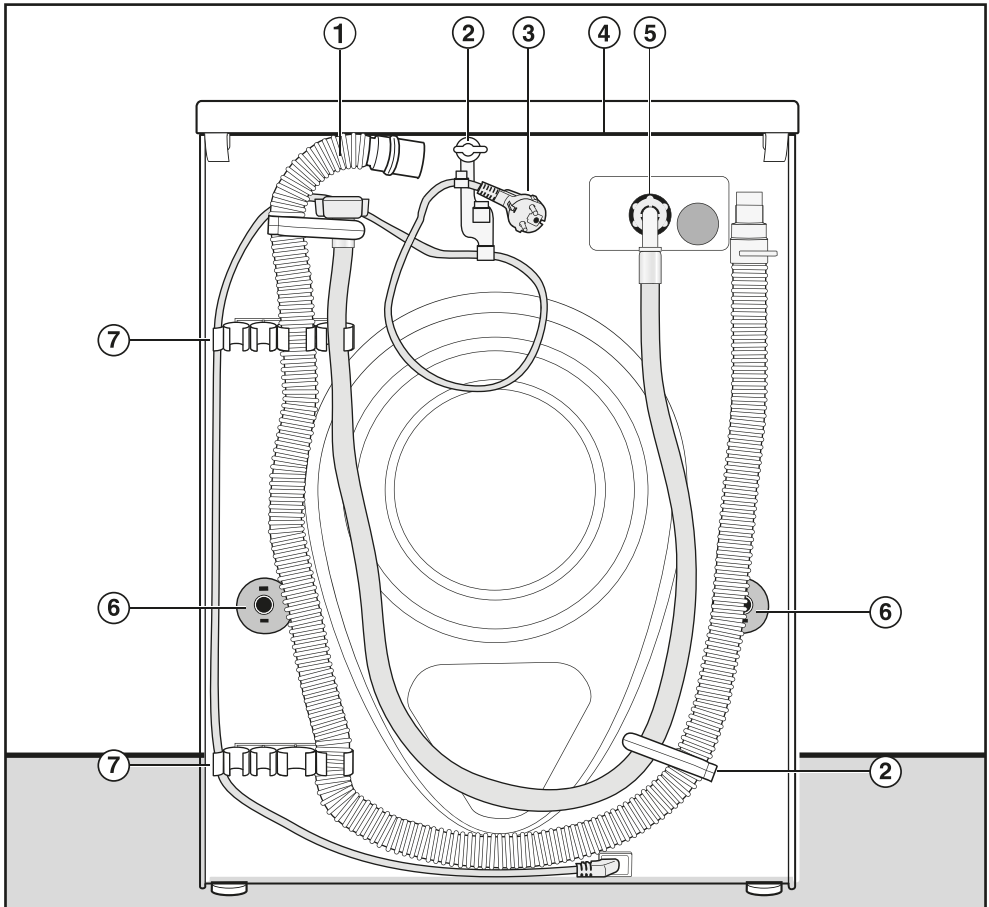

- ① Drain hose
- ② Transport clips for inlet and drain hoses
- ③ Electrical connection
- ④ Protruding lid for holding when moving the machine
- ⑤ Cold water inlet hose
- ⑥ Safety caps for transit bars
- ⑦ Transport clips for inlet and drain hoses and for storing transit bars when not in use

Installation

Installation locations

Side view

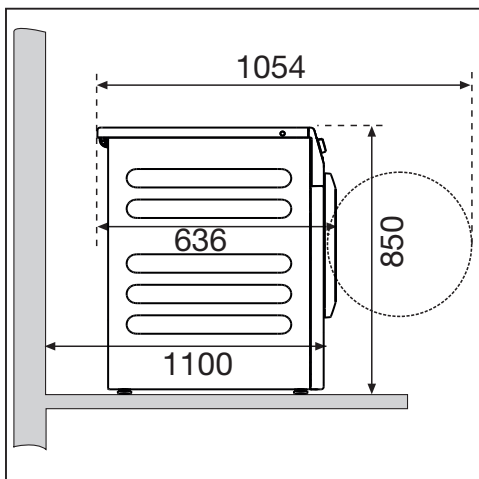

Washer-dryer stack

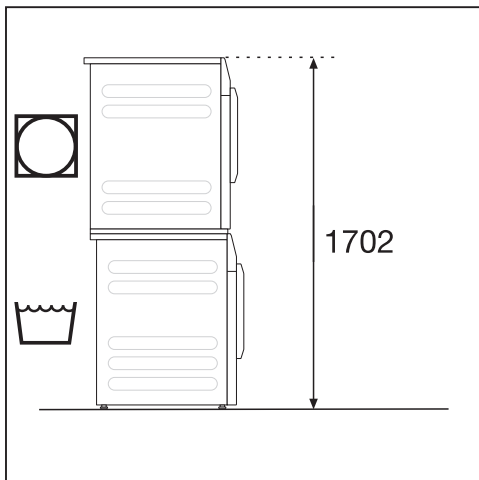

This washing machine can be installed with a Miele tumble dryer on top of it. This requires a Miele washer-dryer stacking kit which can be purchased separately.

Installation on a raised plinth

The washing machine can be installed on a steel plinth (open or closed, available as an optional Miele accessory) or on a concrete plinth.

 Injury can occur if the washing machine has not been adequately secured.

When installed on a plinth, there is a risk that the washing machine will move and fall from the plinth during spinning.

Secure the washing machine using the clamps supplied.

Installation notes

 Risk of damage due to moisture ingress.

Moisture can damage electrical components.

Do not install the machine near or directly above an open gully or floor drain.

Note for installer:

Expanded polystyrene (EPS) packaging included. Please retain and dispose of EPS packaging responsibly. For further information, please contact Miele.

Transporting the washing machine to its installation site

⚠ Danger of injury from incorrect transport.

If the washing machine tips over, there is a danger of injury to people and damage to property.

When transporting the machine, make sure that it is stable.

Transporting the washing machine with a hand trolley

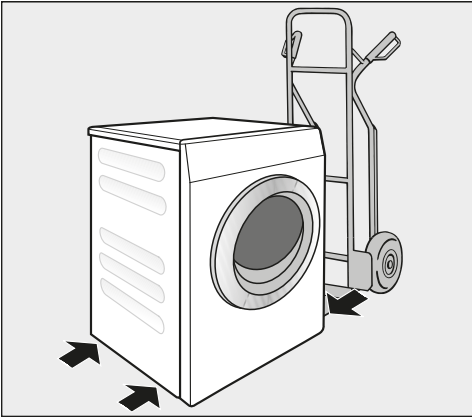

- If transporting the washing machine with a hand trolley, make sure only its left or right side is resting on the trolley.

⚠ Risk of damage from incorrect transport.

The front or back of the washing machine may be damaged if the machine is transported on a hand trolley.

Always transport the washing machine on its side on a hand trolley.

Transporting the washing machine to its installation site

The protruding lid can be used for holding the machine during transport.

⚠ Danger of injury due to unsecured lid.

Make sure the fixings at the back of the lid are secure. They may become brittle due to external circumstances. There is a danger of the lid being pulled off when carrying the appliance.

Before carrying the appliance, check that the lid is secure where it protrudes at the back.

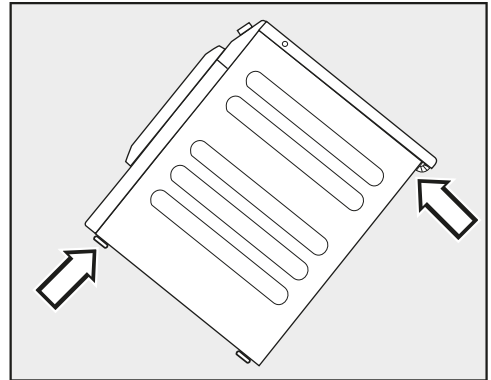

- Carry the washing machine by the front feet and by the lid where it protrudes at the back of the appliance.

Installation

Installation surface

A concrete floor is the most suitable installation surface. It is far less prone to vibration during the spin cycle than wooden floorboards or a carpeted surface.

- The machine must be level and securely positioned.
- To avoid vibrations during spinning, the machine should not be installed on soft floor coverings.

If installing on a wooden joist floor:

- Install the machine on a plywood base (at least 70 x 60 x 3 cm). The base should span several joists and be bolted to the joists and not only to the floorboards.

Useful tip: If possible, install the machine in a corner of the room. This is usually the most stable part of the floor.

Removing the transit bars

Removing the left transit bar

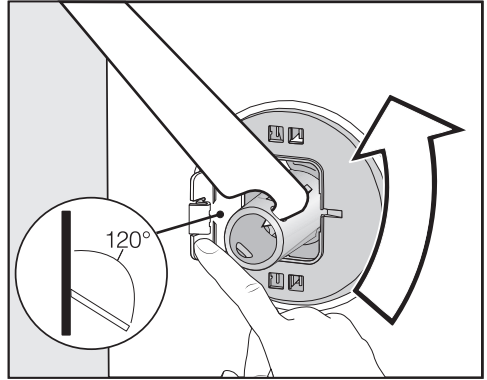

- Push the flap outwards and turn the transit bar 90° using the enclosed spanner.

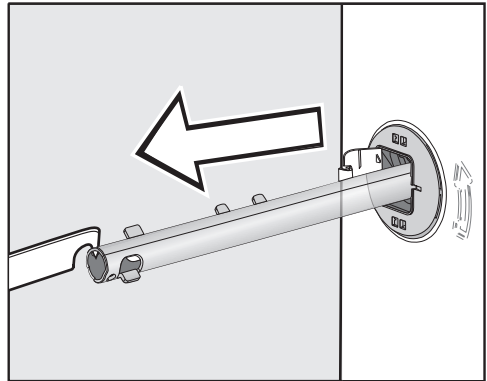

- Then pull the transit bar out.

Removing the right transit bar

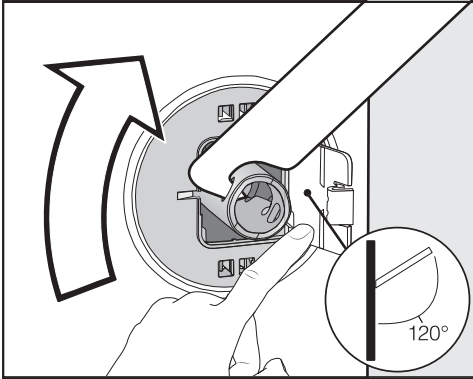

- Push the flap outwards and turn the transit bar 90° using the enclosed spanner.

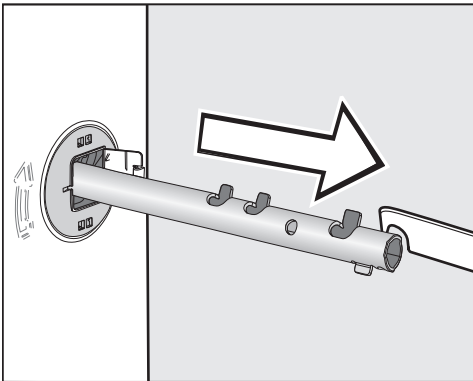

- Then pull the transit bar out.

Covering the holes

⚠ Risk of injury from sharp edges!
There is a risk of injury from reaching into holes that are not covered.
To avoid the risk of injury, the holes for the transit bars must be covered after the transit bars have been removed.

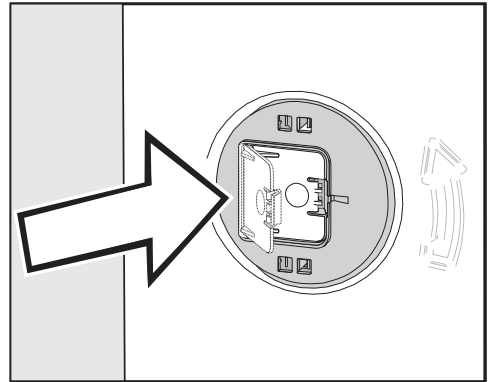

- Press the flaps firmly shut until they click into place.

Installation

Securing the transit bars

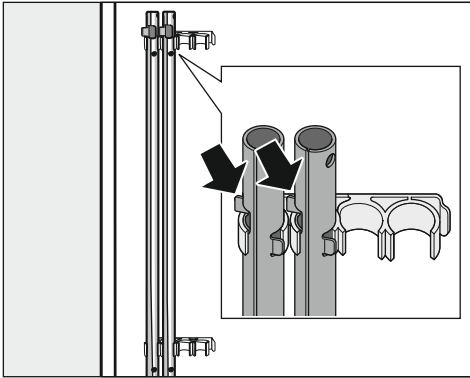

- Secure the transit bars to the back of the washing machine. Make sure that the top catch is located above the holder.

 Risk of damage from incorrect transport.

The washing machine may become damaged if moved without the transit bars in place.

Keep the transit bars in a safe place. Fit them again if the machine is to be moved (e.g. when moving house).

Fitting the transit bars

Opening the flaps

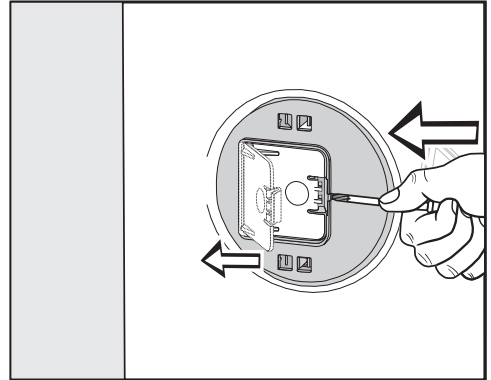

- Push against the catch with a pointed object, e.g. a narrow screwdriver.

The flap will open.

Fitting the transit bars

- Install the transit bars in reverse order to their removal.

Useful tip: If you lift the drum slightly, the transit bars can be pushed in more easily.

Aligning the washing machine

The washing machine must stand perfectly level on all four feet to ensure safe and proper operation.

Incorrect installation may increase electricity and water consumption and may cause the machine to move about.

Screwing out and adjusting the feet

The four adjustable screw feet are used for levelling the washing machine. All four feet are screwed in when the appliance is delivered.

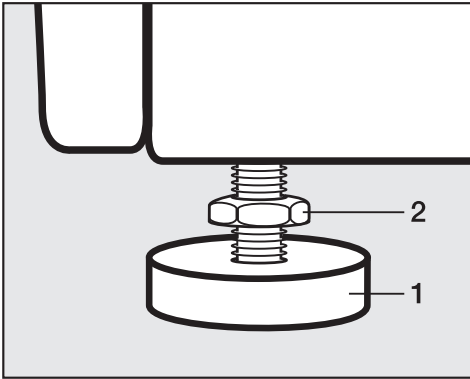

- Using the spanner supplied, turn counter nut **2** in a clockwise direction. Then turn counter nut **2** together with foot **1** to unscrew.

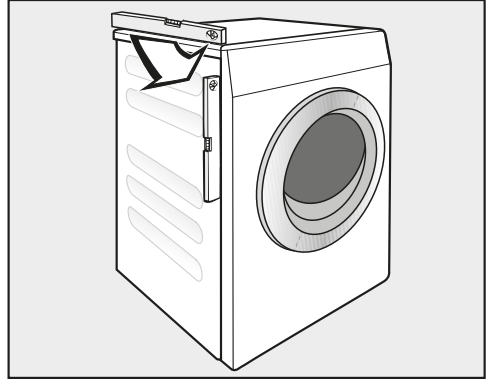

- Use a spirit level to check that the washing machine is standing level.
- Hold foot **1** securely with a pipe wrench. Turn counter nut **2** again using the spanner supplied until it sits firmly up against the housing.

 Risk of damage due to incorrectly aligned washing machine.

There is a danger of the washing machine moving about if the feet are not secured.

Turn all four counter nuts for the feet until they sit firmly up against the housing. Please also check this for the feet which did not need adjustment.

Installing under a continuous worktop

 Risk of electric shock due to exposed cables.

There is a risk of coming into contact with live parts while the lid is removed.

Do not remove the washing machine lid.

This washing machine (with lid intact) can be pushed under a worktop if there is space to do so.

Installation

Fixing bracket for plinth

The fixing bracket prevents the washing machine from falling off a plinth during operation.

Fastening with the fixing bracket is only intended for plinths made from concrete. The plinth must be flat and level. The surface below the plinth must be able to withstand the physical loads. Prior to installation, ensure the plinth complies with the minimum dimensions.

Height: 6 cm

Width: 60 cm

Depth: 65 cm

Positioning the fixing bracket



Risk of injury from sharp edges!

The fixing bracket has sharp edges. You could cut yourself on the edges. Take care when handling the fixing bracket.

Wear gloves while installing the fixing bracket.

The front appliance feet must protrude by at least 3 mm from the bottom of the locknut. The washing machine must already be aligned (see "Installation – Aligning the washing machine").

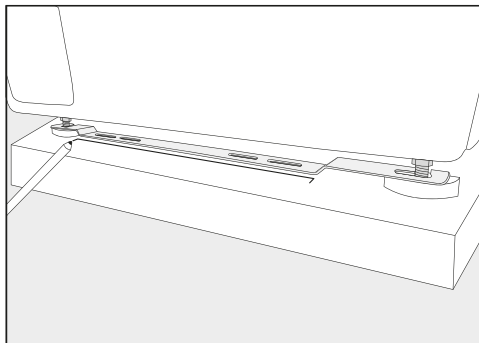

- Place the fixing bracket on the front appliance feet.
- Mark the position of the front edge of the fixing bracket with a pencil.
- Remove the fixing bracket from the feet.
- Carefully move the washing machine until you have enough space to install the fixing bracket.

Installing the fixing bracket

- Place the fixing bracket on the marking on the plinth.
- In the middle of the two outer slotted holes, mark a point for each drill hole.
- Drill 2 holes (8 mm) with a depth of approx. 55 mm.
- Insert the plugs in the holes.

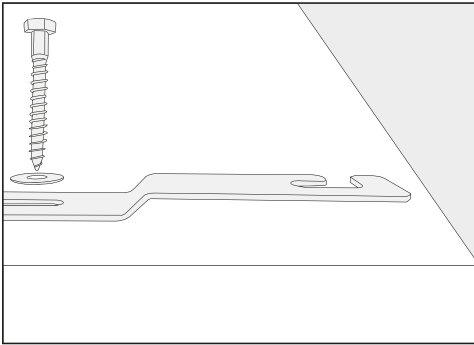

- Install the fixing bracket with the hexagonal screws and the washers.

Do not tighten the screws yet – this will allow the fixing bracket to be moved sideways.

Securing the washing machine with the fixing bracket

- Push the washing machine back on to the installed fixing bracket.

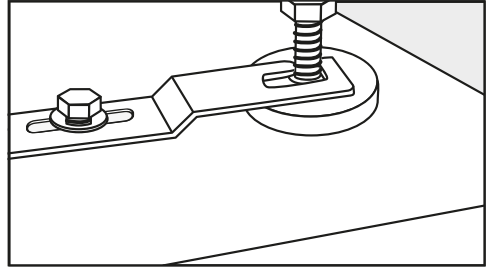

- Insert the appliance feet (the part between the foot and the locknut) into the openings in the fixing bracket.
- Push the fixing bracket to the right as far as it will go.
- Tighten the hexagonal screws using a spanner.

The washing machine is secured in the fixing bracket.

Installation

Water connection

Cold water connection

The washing machine must be connected to a mains water supply in accordance with current local and national safety regulations.

The flow pressure must amount to a minimum of 100 kPa (1 bar) and must not exceed an overpressure of 1000 kPa (10 bar). If the pressure exceeds 1000 kPa, a pressure reducing valve must be installed.

Connection to the mains water supply should incorporate a water tap with a $\frac{3}{4}$ " threaded union. If this is not available, only a qualified plumber may connect the washing machine to the mains water supply.

The connection point is subject to mains water pressure.

Check that the connection is leakproof. Slowly turn on the tap. Correct the position of the seal and union if necessary.

The water inlet hose for cold water is not intended to be used with a hot water connection.

Maintenance

Only use a genuine Miele hose should you ever need a replacement.

A filter is located in the open end of the inlet hose and another in the intake point to protect the inlet valve. Neither filter may be removed.

Hose extension

Longer hoses 2.5 m or 4.0 m in length are available from Miele as optional accessories (depending on country).

IMPORTANT Australia and New Zealand

This appliance must be connected to the water supply in strict accordance with local and national requirements (e.g. Plumbing Code of Australia (PCA)).

This appliance must be installed according to AS/NZS 3500.1 and AS/NZS 3500.2. This washing machine has been supplied with a separate backflow prevention device (non-return valve).

- Disconnect mains power (switch off or unplug the plug).
- Turn off the water tap.
- Place the seals on both side of the non-return valve.
- Connect the female end of the non-return valve to the water tap.
- Connect the hose to the male end of the non-return valve.
- Turn on the tap gradually to test for leaks.

If there is a leak, the connection might not be on securely, or it may have been screwed on at an angle. Unscrew and reconnect the water correctly before tightening it.

Drainage

Drain pump

The suds are drained through a drain pump with a 1 m delivery head. For the water to drain freely, the hose must be free of kinks. An elbow piece (accessory) can be hooked onto the end of the hose.

Drain hose connection options

1. Connected securely to a trapped waste pipe.
2. Connected over the rim of the laundry trough or into the sud-saver pipe of the laundry trough.
3. Connected securely to a floor drain (gully).

If required, the hose can be extended to a length of up to 5 m. The necessary parts can be ordered from Miele (depending on country).

For a delivery head of more than 1 m (up to a max. of 1.6 m) a replacement drain pump will need to be fitted. Please contact Miele for advice.

Waste water discharge from commercial clothes washing machines may require pre-treatment as determined by the utility operator.

Installation

Electrical connection

This description applies to washing machines both with and without a mains plug.

The following applies to washing machines with a mains plug:

- The washing machine is ready to be connected.
- The electrical socket must be easily accessible after installation so that the machine can be disconnected from the electricity supply if necessary.

 Damage caused by incorrect supply voltage.

The data plate indicates the nominal power consumption and the appropriate fuse rating.

Compare the specifications on the data plate with those of the mains electricity supply.

The washing machine may only be connected to a permanent electrical system that conforms to the national and local codes and regulations.

Do not connect the machine to an extension lead or multi-socket adapter as they do not guarantee the required safety of the appliance (e.g. danger of overheating).

If the appliance is hard wired, a dual circuit breaker must be provided on site. When switched off, there must be an all-pole contact gap of at least 3 mm in the isolator switch (including circuit breakers, fuses, and relays according to AS/NZS 3000). This connection must be carried out by a qualified and competent electrician.

The plug connector or isolator switch should be easily accessible at all times.

 Risk of electric shock!

If the washing machine is disconnected from the power supply, protective measures must be taken to ensure that the point of disconnection cannot accidentally be switched on again.

Make sure the isolator is lockable or the point of disconnection is monitored at all times.

New connections, modifications to the system, or servicing of the protective earthing conductor, including determining the correct fuse rating, must be carried out by a qualified and competent electrician, as they are familiar with the pertinent regulations and the specific requirements of the electric utility company.

Technical data

Height	850 mm
Width	596 mm
Width (machines with a stainless steel lid)	605 mm
Depth	636 mm
Depth with door open	1054 mm
Weight	Approx. 100 kg
Maximum floor load in operation	3000 Newton
Capacity	8.0 kg dry laundry
Supply voltage	See data plate on back of machine
Rated load	See data plate on back of machine
Fuse rating	See data plate on back of machine
A-rated sound emissions L_{pA} in accordance with EN ISO 11204/11203	< 70 dB re 20 μ Pa
Minimum water flow pressure	100 kPa (1 bar)
Maximum water flow pressure	1000 kPa (10 bar)
Water inlet hose length	1.55 m
Drain hose length	1.50 m
Mains connection cable length	2.00 m
Product safety standard	EN 50571, AS/NZS 60335
Test certifications awarded	see data plate
Off mode	0.17 W

Programmable functions

The programmable functions are used to alter the machine's electronics to suit changing requirements. Programmable functions can be altered at any time.

Programming is carried out in 9 steps (1, 2, 3 ... 9) using the sensors.

Opening the programming level

Before you begin, ensure the following:

- The washing machine is switched on (the programme selector is pointing to a wash programme).

- The washing machine door is open.

1 Touch the *Start/Add laundry* sensor and hold it down whilst carrying out steps 2–3.

2 Close the washing machine door.

3 Wait until the *Start/Add laundry* sensor lights up constantly ...

4 ... and then release the *Start/Add laundry* sensor.

After a few seconds, *P11* will light up in the time display.

Choosing and selecting programmable functions

The number of the programmable function will appear in the display as *P* and a number: e.g. *P11*.

5 Touch the > or < sensor to scroll to the next or previous programmable function:

Programmable functions	
<i>P11</i>	Buzzer duration
<i>P12</i>	Buzzer
<i>P13</i>	Keypad tone
<i>P14</i>	PIN code
<i>P22</i>	Display switch-off status
<i>P24</i>	Memory
<i>P26</i>	Additional pre-wash time
<i>P28</i>	Gentle action
<i>P29</i>	Temperature reduction
<i>P32</i>	Maximum rinse level
<i>P33</i>	Suds cooling
<i>P34</i>	Anti-crease
<i>P49</i>	Low water pressure
<i>P62</i>	Backlight brightness dimmed
<i>P63</i>	Welcome tone
<i>P90</i>	Operating hours
<i>P97*</i>	Remote control
<i>P98*</i>	SmartGrid
<i>P99*</i>	RemoteUpdate
<i>P00</i>	Factory default setting

* only visible after networking

6 Confirm the selected programmable function by touching the *Start/Add laundry* sensor.

Editing and saving the programmable function

You can switch a programmable function on/off or select different options.

- Touch the > or < sensor to switch a programmable function on/off or to select an option.

Programmable function	Available options				
	-00	-01	-02	-03	-04 to -07
P11		•	•		
P12	•	•	•		
P13	•	•	•		
P14	•	•			
P22	•	•			
P24	•	•			
P26	•	•	•	•	
P28	•	•			
P29	•	•			
P32	•	•			
P33	•	•			
P34	•	•			
P49	•	•			
P62		•	•	•	•
P63	•	•			
P97	•	•			
P98	•	•			
P99	•	•			
P00	•	•			

- Confirm the chosen selection with the *Start/Stop* sensor.

The number of the programmable function, e.g. *P11*, will light up again.

Exiting the programming level

- Turn the programme selector to the  position.

The settings have been changed. You can alter the settings again at any time.

P11 Buzzer duration

The buzzer sounds to let you know the programme has finished. You can decide how long the buzzer should sound for.

Options

- 01 = The buzzer sounds 3 times at the end of the programme.
- 02 = The buzzer sounds until the washing machine switches off automatically (max. 1 hour).

P12 Buzzer

The buzzer sounds to let you know the programme has finished.

Options

- 00 = Buzzer is deactivated.
- 01 = Buzzer volume is set to normal.
- 02 = Buzzer volume is set to loud.

Programmable functions

P13 Keypad tone

Each touch of a sensor is confirmed with an audible tone.

Options

- 00 = Keypad tone is switched off
- 01 = Keypad tone is set to loud volume
- 02 = Keypad tone is set to loud volume

P14 PIN code

The PIN code prevents the washing machine being used without your knowledge.

When the code has been activated, you have to enter a code after switching the washing machine on. Otherwise the washing machine cannot be operated.

Options

- 00 = PIN code is switched off
- 01 = PIN code is switched on

Using the washing machine with a PIN code

The code is **125** and cannot be altered.

- Switch on the washing machine.

0 __ appears in the time display and the > and < sensors light up.

- Touch the > sensor once.

! __ appears in the time display.

- Confirm the number with the *Start/Add laundry* sensor.

The first number was saved and you can now enter the second number using the > and < sensors.

- Enter the second and third numbers and confirm the numbers with the *Start/Add laundry* sensor.

The lock is released and a wash programme can now be selected and started.

P22 Control panel switch-off status

To save energy, the time display and sensors will go out after 10 minutes, and only the *Start/Add laundry* sensor will flash slowly.

Options

- 00 = Off
The time display and sensors will remain lit up while the washing machine is switched on

- 01 = On
The time display and sensors will switch off after 10 minutes if a programme has started.

However, the time display and sensors will remain lit up for 10 minutes after a Delay start time has elapsed, after the end of a programme, or at the end of the Anti-crease phase.

P24 Memory

The washing machine will save the last settings (temperature, spin speed and some of the Extras) selected for a programme after the programme has started.

When the programme is selected again, the saved settings will appear in the display.

Options

- 00 = Memory is switched off
- 01 = Memory is switched on

P26 Longer pre-wash Cottons

If you require a longer pre-wash, you can extend the pre-wash time.

Options

- 00 = no increase in the pre-wash time
- 01 = + 6 minutes increase in the pre-wash time
- 02 = + 9 minutes increase in the pre-wash time
- 03 = + 12 minutes increase in the pre-wash time

P28 Gentle action

With Gentle action activated, drum agitation is reduced. In this way, lightly soiled items can be washed more gently.

Gentle action can be activated for the *Cottons* and the *Minimum iron* programmes.

Options

- 00 = Gentle action is switched off
- 01 = Gentle action is switched on

P29 Temperature reduction

At high altitudes water has a lower boiling point. Miele recommends activating the Temperature reduction setting at high altitudes to prevent water from boiling.

Options

- 00 = The Temperature reduction setting is switched off
- 01 = The Temperature reduction setting is switched on

P32 Maximum rinse level

The water level in the rinse can be permanently set to the highest value.

This function is important for allergy sufferers as it achieves excellent rinse results. The water consumption will be increased.

Options

- 00 = Maximum rinse level is switched off
- 01 = Maximum rinse level is switched on

Programmable functions

P33 Suds cooling

Additional water flows into the drum at the end of the main wash to cool the suds down. Hot suds can damage plastic drainage pipes.

Suds cooling takes place when a Cottons programme with a temperature of 70°C or higher is selected.

Suds cooling should be activated:

- to prevent the danger of scalding if the drain hose is hooked over the edge of a sink or basin.
- where the drainage pipes are rated less than 70°C.

Options

- 00 = Suds cooling is switched off
- 01 = Suds cooling is switched on

P34 Anti-crease

The Anti-crease function helps prevent creasing if laundry is not going to be removed immediately after the end of the programme.

The drum continues to turn at intervals for up to 30 minutes at the end of the programme. The door can be opened at any time during the Anti-crease phase.

Options

- 00 = The Anti-crease function is switched off
- 01 = The Anti-crease function is switched on

P49 Low water pressure

If the water pressure is below 100 kPa (1 bar), the washing machine cancels the programme and the  fault message appears.

If the water pressure cannot be increased, activating this function will prevent the programme from being cancelled.

Options

- 00 = Low water pressure is switched off
- 01 = Low water pressure is switched on

P62 Backlight brightness dimmed

The brightness of the dimmed sensors in the control panel can be set to one of 7 different levels.

The brightness will change as soon as a different setting is chosen.

Options

- 01 = Darkest level
- ↓
- 07 = Brightest level

P63 Welcome tone

The welcome tone sounds whenever the washing machine is switched on.

You can switch the welcome tone on or off.

Options

- 00 = Welcome tone is switched off
- 01 = Welcome tone is switched on at **normal** volume
- 02 = Welcome tone is switched on at **loud** volume

P90 Operating hours

You can read off how many hours the washing machine has been in operation for.

The total washing time is shown in the time display in single digits. The washing machine has been in operation for 1234 hours, for example. The figure shown in the time display will start with an *H* followed by a 1, then a 2 and after this a 3 and a 4. The letter *H* is displayed again after this.

P00 Factory default setting

All programmable functions except P90 Operating hours are reset to the factory default settings.

Options



- 00 = Go back (without reset to factory default settings)
- 01 = Reset programmable functions to the factory default settings.

Networking

The P97, P98 and P99 programmable functions are only displayed if the requirements for using Miele@home have been met (see “Before using for the first time - Miele@home”).

Resetting the network configuration

The network configuration should be reset whenever a washing machine is being disposed of or sold, or if a used washing machine is being put into operation. This is the only way to ensure that you have removed all personal data and, in the case of the latter, the previous owner can no longer access the washing machine.

- Turn the programme selector to the *MobileStart* programme.
Con appears in the time display.
 - Touch  and hold the  sensor until the countdown in the time display has finished.
- appears in the time display.

The network configuration has been deleted.

A new connection set-up has to be carried out in order to use Miele@home again.

Programmable functions

***P97* Remote control**

You can use the Miele App to check the status of your washing machine from anywhere and start it remotely. You can also control it remotely via the *MobileStart* programme.

You can switch off the *P97* programmable function if you do not want to operate the washing machine with your mobile device.

If the *P97* programmable function is not switched on, the App can still be used to cancel the programme.

Use the  sensor to set a time period within which you want to start the washing machine and start the Delay start function (see “Delay start/ SmartStart”). The washing machine will then start within the time period specified when it receives your signal. If it has not received a start signal by the latest start time set, the washing machine will start automatically.

Options

- 00 = Remote control function is switched off
- 01 = The remote control function is switched on

***P98* SmartGrid (only functional in selected countries)**

You can set your washing machine to start automatically based on an external signal within a certain time period.

If you have activated SmartGrid, the  sensor will have the new “SmartStart” function instead of the “Delay start” function.

Use the  sensor to set a SmartStart time period. The washing machine will then start within the time period specified by you when it receives an external signal. If an external signal has not been received by the latest start time set, the washing machine will start automatically (see “Delay start”).

Options

- 00 = SmartGrid is switched off
- 01 = SmartGrid is switched on

PPP RemoteUpdate

The RemoteUpdate function is used for updating the software in your washing machine. If an update is available for your washing machine, it will automatically download it. Updates will not be installed automatically. They must be initiated manually.

If you do not install an update, you can continue to use your washing machine in the usual way. However, Miele recommends installing updates.

Running a RemoteUpdate

Information about the content and scope of an update is provided in the Miele App.

The message *UP* will appear in the time display if an update is available.

You can install the update immediately or postpone this until later. When the washing machine is switched on again, you will be reminded about the update.

Switch off RemoteUpdate if you do not want to install any updates.

The update may take several minutes.



Please note the following information about the RemoteUpdate function:

- You will only receive a message when an update is available.
- Once an update has been installed, it cannot be undone.
- Do not switch off the washing machine during an update. Otherwise, the update will be aborted and will not be installed.
- Some software updates can only be carried out by a Miele service technician.

Activating/Deactivating

The RemoteUpdate function is activated as standard. Available updates will be downloaded automatically but will only be installed if you initiate the installation manually. Deactivate RemoteUpdate if you do not want any updates to be downloaded automatically.

Options

-  = RemoteUpdate is deactivated
-  = RemoteUpdate is activated
(factory default setting)

Starting the update

After the washing machine is switched on, *UP* appears in the time display.

- Touch the *Start/Add laundry* sensor.

UP starts to flash in the time display. The update starts.

Bars in the time display show the progress of the update:

| = 0 %

|||||| = 100 %

Postponing the update

After the washing machine is switched on, *UP* appears in the time display.

- Touch the  sensor.

The running time of the selected programme appears in the time display.

The next time you switch on the appliance, you will be prompted to start the update again.

Programmable functions

Copyright and licences for the communication module

For the purpose of operating and controlling the communication module, Miele uses proprietary or third-party software that is not covered by open source licensing terms. These items of software/software components are protected by copyright. The copyright powers of Miele and third parties must be respected.

In addition, the communication module contains software components which are distributed under open source licensing terms. The open source components contained in the appliance along with the corresponding copyright notices, copies of the licensing terms valid at the time, and any further information can be accessed locally via IP using a web browser (*http://<IP address>/Licenses*), where <IP address> is the IP address of the appliance. The liability and warranty arrangements for the open source licences displayed in this location only apply in relation to the respective rights holders.

Miele Australia Pty. Ltd.

ACN 005 635 398

ABN 96 005 635 398

Melbourne:

Level 4, 141 Camberwell Road

Hawthorn East, VIC 3123

Telephone: 1300 731 411

professional.service@miele.com.au

www.miele.com.au/professional

professional.sales@miele.com.au

Miele New Zealand Limited

IRD 98 463 631

8 College Hill

Freemans Bay

Auckland 1011

New Zealand

Telephone: 0800 4 MIELE

(0800 464 353)

www.miele.com.au/professional

professional.sales@miele.com.au



Miele Global Headquarters: Miele & Cie. KG
Carl-Miele-Straße 29, 33332 Gütersloh, Germany

PWM 1108

en-AU, NZ

M.-Nr. 12 549 791 / 01 / 002