





Operating and installation instructions Washing machine



Always read the operating instructions before setting up, installing and commissioning the machine. This prevents both personal injury and damage to the machine.

Contents

Caring for the environment	6
Warning and safety instructions	7
Operating the washing machine	13
Control panel.....	13
Symbols on the control panel.....	14
Symbols on the display	15
Sensor controls and touch display with sensor controls.....	16
Main menu	16
Examples of how to operate the appliance	17
Before using for the first time	18
Washing environmentally and economically	22
1. Preparing the laundry	23
2. Loading the washing machine	24
3. Selecting a programme	25
4. Selecting programme settings	26
5. Adding detergent	27
Adding fabric conditioner or liquid starch separately	28
Adding starch separately	28
6. Starting the programme – the end of the programme	29
Delay start	30
Programme chart	31
Special programmes	33
Programme packages	35
Extras	42
Pre-wash 	42
Pre-rinse 	42
Pre-ironing 	42
Rinse plus 	42
Special features in the programme sequence	43
Spinning	43
Anti-crease	43
Changing the programme sequence	44
Changing a programme	44
Cancelling a programme.....	44
Switching on the washing machine after an interruption to the power supply.....	44
Adding or removing laundry	45

Detergent	46
The correct detergent	46
Recommended detergents in accordance with Directive (EU) No. 1015/2010	46
Cleaning and care	47
Cleaning the casing and fascia panel	47
Cleaning the detergent drawer	47
Cleaning the drum, suds container and drainage system	48
Cleaning the sealing ring	49
Cleaning the water inlet filters	49
Problem solving guide	50
The wash programme does not start	50
Programme cancellation and error message	51
A fault message appears in the display	52
An unsatisfactory wash result	53
General problems	54
The door will not open	55
Opening the door in the event of a blocked drain outlet and/or power cut	56
Miele Service	59
Contact in case of malfunction	59
EPREL database	59
Optional accessories	59
Installation	60
Front view	60
Rear view	61
Installation locations	62
Installation notes	62
Transporting the washing machine to its installation site	63
Installation surface	64
Removal of transit bars	64
Fitting the transit bars	66
Levelling the washing machine	66
Holding bracket for plinth	67
External control equipment	69
Payment system	69
Water connection	70
Cold water connection	70
Hot water connection*	71
Drainage	71
Drain valve	71
Drain pump	71

Contents

Electrical connection	72
Technical data	73
EU Conformity declaration.....	74
UK Conformity declaration	74
Consumption data	75
Supervisor level	77
Code-based access	77
Changing the code	77
Opening the Supervisor level.....	77
Exiting the Supervisor level.....	77
Language.....	77
Brightness.....	77
Clock display	78
Finish tone volume	78
Keypad tone volume.....	78
Welcome tone volume.....	78
Fault alarm	78
Memory	78
Anti-crease	78
Suds cooling.....	78
"Display" switch-off status	79
Delay start	79
Programme name	80
Visibility parameters	80
Pre-wash water.....	80
Main wash water	80
First rinse water	80
Final rinse water.....	80
Low water pressure	81
Empty sensor.....	81
Early warning counter	81
Water level Cottons	81
Water level Minimum iron.....	81
Cottons Pre-wash temp	81
Wash time Pre-wash.....	81
Wash time Cottons	82
Wash time Minimum iron.....	82
Pre-rinse Cottons	82
Pre-rinse Minimum iron.....	82
Pre-wash Cottons/Min. iron	82
Cottons rinses.....	82
Min. iron rinses	82

Disinfection rinse.....	82
Programme packages	83
Disinfection prog. code.....	83
Temp reduction	83
Auto load control	83
CapDosing.....	83
Pre-ironing.....	83
Hygiene	84
Automatic dispensing	84
Adjustment value dosage 1–6	84
COM module selection	85
Availability of Miele digital products.....	85
WiFi/LAN	85
Network time	86
Peak load signal	87
Peak load prevention.....	87
Remote.....	87
RemoteUpdate	87
SmartGrid.....	88
Clean the drain pump	88
Legal information	88
Copyrights and licences for operator and control software	88
Payment system.....	89
Settings for payment systems	89
Feedback signal to pay system.....	89
Payment system lock	89
FOC programmes	90
Delete paid signal	90
Debounce time.....	90

Caring for the environment

Disposing of the packaging material

The packaging material is used for handling and protects the appliance from transport damage. The packaging material used is selected from materials which are environmentally friendly for disposal and can generally be recycled.

Recycling the packaging material reduces the use of raw materials. Use material-specific collection points for valuable materials and take advantage of return options. Your Miele dealer will take the packaging material away.

Disposing of your old appliance

Electrical and electronic appliances contain many valuable materials. They also contain certain materials, compounds and components which were essential for their correct functioning and safety. These could be hazardous to human health and to the environment if disposed of with household waste or if handled incorrectly. Please do not, therefore, dispose of your old appliance with household waste.



Instead, please make use of officially designated collection and disposal points to dispose of and recycle electrical and electronic appliances in your local community, with your dealer or with Miele, free of charge. By law, you are solely responsible for deleting any personal data from the old appliance prior to disposal. You are legally obliged to remove any old batteries which are not securely enclosed by the appliance and to remove any lamps without destroying them, where this is possible. These must be taken to a suitable collection point where they can be handed in free of charge. Please ensure that your old appliance poses no risk to children while being stored for disposal.

Warning and safety instructions

This washing machine complies with all current local and national safety requirements. However, inappropriate use can lead to personal injury and damage to property.

Read the operating instructions carefully before using the washing machine. They contain important information on safety, installation, use and maintenance. This prevents both personal injury and damage to the washing machine.

In accordance with standard IEC 60335-1, Miele expressly and strongly advises that you read and follow the instructions in the chapter on installing the washing machine as well as the safety instructions and warnings.

Miele cannot be held liable for damage caused by non-compliance with these instructions.

Keep these operating instructions in a safe place and pass them on to any future owner.

When instructing other people how to use the washing machine, they must be made aware of these safety and warning instructions.

Appropriate use

- ▶ The washing machine is only suitable for washing fabrics with a care label stating that they are suitable for machine washing. Any other applications may be dangerous. The manufacturer cannot be held liable for damage resulting from incorrect or improper use or operation of the machine.
- ▶ This washing machine must be used as described in the operating instructions and must be checked on a regular basis to make sure it is functioning correctly. Maintenance must be carried out when necessary.
- ▶ The washing machine is not suitable for outdoor use.
- ▶ This washing machine may also be operated in public areas.
- ▶ This washing machine can only be used by people with reduced physical, sensory or mental capabilities, or lack of experience or knowledge, if they are supervised whilst using it or have been shown how to use it in a safe way and understand and recognise the consequences of incorrect operation.
- ▶ Children under the age of 8 must not be allowed near the washing machine unless they are constantly supervised.

Warning and safety instructions

- ▶ Children over the age of 8 may only use the washing machine without supervision if its operation has been clearly explained to them and they are able to use it safely. Children must be able to understand and recognise the possible dangers caused by incorrect operation.
- ▶ Children may not carry out cleaning or maintenance on the washing machine unsupervised.
- ▶ Always supervise any children in the vicinity of the washing machine. Never allow children to play with the washing machine.
- ▶ Disinfection programmes must not be interrupted, as this can have a limiting effect on the disinfection result. It is the operator's responsibility to ensure that the standard of disinfection in thermal as well as chemo thermal procedures is maintained by carrying out suitable validation tests.

Technical safety

- ▶ Before setting up the washing machine, check it for any externally visible damage. Do not set up or use a damaged washing machine.
- ▶ The electrical safety of the washing machine can only be guaranteed when correctly earthed.

It is most important that this basic safety requirement is tested and in case of any doubt the on-site wiring system should be inspected by a qualified electrician.

Miele cannot be held liable for the consequences of an inadequate earthing system.

- ▶ Unauthorised repairs could result in unforeseen dangers for the user, for which the manufacturer cannot accept liability. Repairs should only be undertaken by a Miele approved service technician, otherwise any subsequent damage will not be covered by the warranty.
- ▶ Do not make any alterations to the machine, unless authorised to do so by Miele.
- ▶ The machine must be isolated from the electricity supply when cleaning and maintaining the machine and in the event of a fault:
 - switch off at the wall and disconnect the plug from the socket, or
 - disconnect the fuse at the mains circuit board, or
 - unscrew the on-site screw-in fuse.

See “Installation – Electrical connection”.

Warning and safety instructions

- ▶ If the electrical connection cable is faulty it must only be replaced by a Miele authorised service technician to protect the user from danger.
- ▶ The washing machine must only be connected to the on-site water supply using a new hose kit. Old hoses must not be re-used. Check the hose regularly for signs of wear. Replace it in good time to avoid the risk of leaks and subsequent damage.
- ▶ Faulty components must only be replaced by genuine Miele original spare parts. Miele can only guarantee the safety standards of the machine when Miele replacement parts are used.
- ▶ For reasons of safety, do not connect the machine to the mains electricity supply by an extension lead, multi-socket adapter, or similar. These can overheat and are a fire hazard.
- ▶ In the case of commercial use, all relevant national provisions and regulations (DGUV in Germany) relating to accident insurance are applicable to this machine. It is recommended to carry out testing in accordance with national regulations (e.g. the regulatory framework described in DGUV100-500/Chapter 2.6/Section 4). The test book required for the documentation is available from Miele.
- ▶ The machine must not be used in a non-stationary location (e.g. on a ship).
- ▶ Please observe the instructions in “Installation” and “Technical data”.
- ▶ If the washing machine is equipped with an electrical plug connection, it must be easily accessible after installation so that the machine can be disconnected from the electricity supply if necessary.
- ▶ If the appliance is hard wired, an on-site all pole circuit breaker must always be accessible to disconnect the washing machine from the mains.
- ▶ This washing machine is supplied with a special lamp to cope with particular conditions (e.g. temperature, moisture, chemical resistance, abrasion resistance and vibration). This lamp must only be used for the purpose for which it is intended. The lamp is not suitable for room lighting. Replacement lamps may only be fitted by a Miele authorised technician or by the Miele Customer Service Department. This washing machine contains 1 light source corresponding to energy efficiency class G.

Warning and safety instructions

▶ Temporary or permanent operation on an autonomous power supply system or a power supply system that is not synchronised with the mains power supply (e.g. island networks, backup systems) is possible. A prerequisite for operation is that the power supply system complies with the specifications of EN 50160 or an equivalent standard.

The function and operation of the protective measures provided in the building's electrical installation and in this Miele product must also be maintained in isolated operation or in operation that is not synchronised with the mains power supply, or these measures must be replaced by equivalent measures in the installation. As described, for example, in the current version of VDE-AR-E 2510-2.

▶ While the washing machine is under warranty, repairs should only be undertaken by a Miele authorised service technician. Otherwise the warranty will be invalidated.

Correct use

▶ The maximum dry laundry weight is 7.0 kg. The maximum recommended loads for individual programmes are given in the Programme chart.

▶ Do not install your washing machine in a room where temperatures below freezing may occur. Frozen hoses may burst or split. The reliability of the electronic control unit may be impaired at temperatures below freezing point.

▶ Before using the machine for the first time, check that the transit bars at the rear of the washing machine have been removed (see "Installation – Removing transit bars"). During spinning, transit bars which are still in place may result in damage to both the machine and adjacent furniture or appliances.

▶ Close the stopcock if the machine is to be left for any length of time (e.g. while on holiday), especially if there is no floor drain (gully) in the immediate vicinity.

▶ Danger of flooding! If hooking the drain hose into a wash basin, check that the water can drain off quickly enough to prevent the sink from overflowing. Hook the hose over the edge and secure. If the hose is unsecured, the force of the water flowing out of it can dislodge it from the basin.

Warning and safety instructions

- ▶ Take care to ensure that foreign objects (e.g. nails, pins, coins, paper clips) do not find their way into the machine with the laundry. These may damage components of the machine (e.g. suds container, drum). Damaged components can damage the laundry.
- ▶ If the correct amount of detergent is dispensed, the machine should not need to be descaled. If, however, you do wish to descale it, only use special non-corrosive descaling agents and strictly observe the instructions on the packaging. Special descaling agent is available from your Miele dealer or from Miele Service. Strictly observe the instructions for the descaling agent.
- ▶ For textiles that have been treated with solvent-based detergents, always check whether they can be washed in a washing machine. To check whether this is possible, refer to safety notes, information concerning the product's environmental properties, and other information.
- ▶ Never use solvent based detergents, e.g. those containing benzene, in this machine. Doing so may result in damage to component parts and create toxic fumes. Risk of fire and explosion.
- ▶ Benzene, petrol, paraffin, or any easily flammable liquid must not be stored or used near the machine. Risk of fire and explosion
- ▶ Only use dyes suitable for use in a washing machine. Always observe the manufacturer's instructions carefully.
- ▶ Colour run and dye removers contain sulphur compounds which can cause damage such as corrosion. Do not use these products in this washing machine.
- ▶ Avoid contact between stainless steel surfaces (front, lid, casing) and liquid detergents or disinfecting agents which contain chlorine or sodium hypochlorite. These agents can have a corrosive effect on stainless steel. Aggressive vapours containing chlorine can also be corrosive. Do not store open containers of these agents near the machine.
- ▶ Do not use a pressure washer or hose to clean the washing machine.
- ▶ It is particularly important to observe manufacturer's instructions when using a combination of cleaning agents and special application products. Products must only be used for applications approved by the manufacturer to avoid any material damage or the occurrence of strong chemical reactions.

Warning and safety instructions

- ▶ If detergent has come into contact with the eyes, rinse out immediately with plenty of lukewarm water. If detergent has accidentally been ingested, seek medical advice immediately. People with damaged or sensitive skin should avoid contact with detergent.
- ▶ When adding or removing laundry during the main wash, your skin may come into contact with detergent, particularly if the detergent is dispensed externally. Take care when placing your hands inside the drum. If suds have come into contact with the skin, rinse off immediately with lukewarm water.



Accessories

- ▶ Only use original Miele accessories. If other parts are used, warranty, performance and product liability claims will be invalidated.
- ▶ Miele tumble dryers and Miele washing machines can be installed as a washer-dryer stack. This requires a Miele washer-dryer stacking kit which can be purchased separately. Please ensure that the washer-dryer connection kit is suitable for the Miele tumble dryer and the Miele washing machine.
- ▶ If installing the machine on a Miele plinth (available as an optional accessory), please make sure you order the correct one for this washing machine.
- ▶ Miele will guarantee to supply functional spare parts for a minimum of 10 years and up to 15 years following the discontinuation of your washing machine.

Miele cannot be held liable for damage caused by non-compliance with these warning and safety instructions.

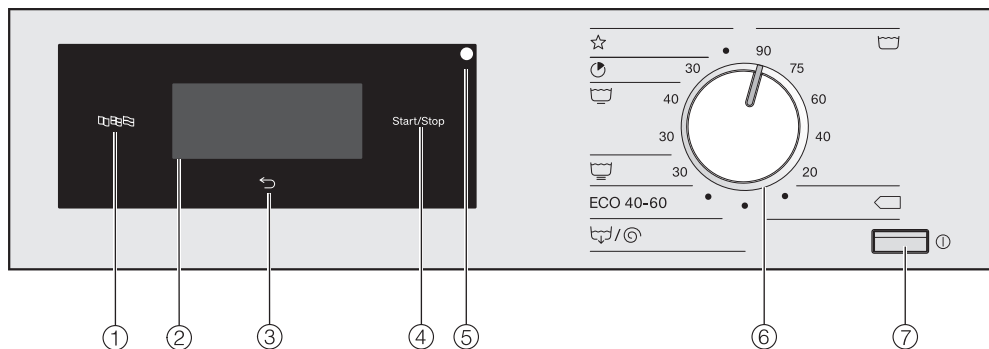
Control panel



- ① **Language sensor control** 
For selecting the current user language. The system language is displayed again at the end of the programme.
- ② **Touch display with sensor controls**
Displays the selected programme. The programme settings are selected using the sensor controls in the touch display.
- ③ **Back sensor control** 
Takes you back one level in a menu.
- ④ **Start/Stop sensor control**
Starts the selected programme and cancels a programme once it has started.
- ⑤ **Optical interface**
For the Customer Service Department.
- ⑥ **Programme selector**
For selecting the wash programme. The programme selector can be turned clockwise or anticlockwise.
- ⑦ **Button** 
For switching the washing machine on and off. The washing machine switches itself off automatically to save energy. It is switched off 15 minutes after the end of the programme/Anti-crease phase, or after being switched on if no further selection is made.

Operating the washing machine

Symbols on the control panel

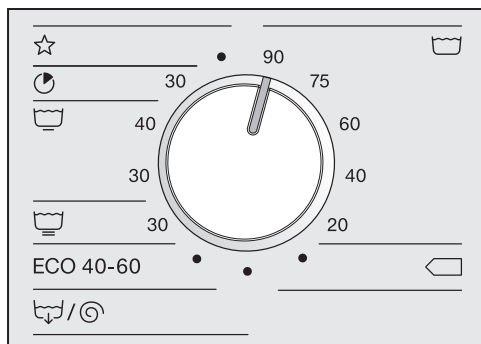

Cottons



Cottons <40°C> / <60°C>



Special programmes



Express



Minimum iron



Delicates

ECO 40-60

Cottons ECO 40-60



Drain/Spin

Symbols on the display



Temperature: use the *Temperature* sensor to set the temperature of the wash programme.



Spin speed: use the *Spin speed* sensor to set the spin speed of the wash programme.



Extras: use the *Extras* sensor to add Extras to a wash programme.



Pre-wash: use the *Pre-wash* sensor to select the *Pre-wash* Extra for a wash programme.



Pre-ironing: use the *Pre-ironing* sensor to select the *Pre-ironing* Extra for a wash programme.



Soak: use the *Soak* sensor to can select the *Soak* Extra for a wash programme.



Rinse plus: use the *Rinse plus* sensor to add an additional rinse cycle to a wash programme.



Further choices: use the *Further choices* sensor to set further options.



Supervisor level: use the *Supervisor level* sensor to alter the washing machine's settings.



Delay start: use the *Delay start* sensor to set the starting time of a wash programme ...





... or the finish time



... or the time until the programme starts.

Operating the washing machine

Sensor controls and touch display with sensor controls

The sensor controls ,  and *Start/Stop* and the sensor controls in the display respond to finger tip contact. Every touch of a sensor is confirmed with an audible tone. You can adjust the volume of the keypad tone or switch it off (see information on “Supervisor level”).

The control panel with sensor controls and the touch display can be scratched by pointed or sharp objects, e.g. pens.
Only touch the display with your fingers.

Main menu

The main menu displays different values depending on the programme.

For programmes with a fixed temperature setting:

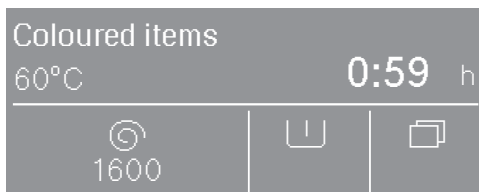

- Selected programme with the set temperature
- Programme duration
- Spin speed set
- Selectable Extras
- Further available options and the settings on the Supervisor level

For programmes with a variable temperature setting:

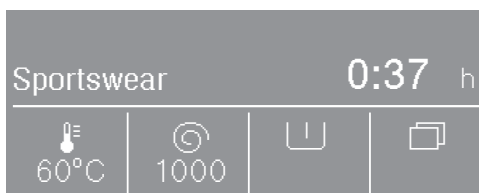

- Selected programme
- Programme duration
- Temperature set
- Spin speed set
- Selectable Extras
- Further available options and the settings on the Supervisor level

Operating the washing machine

Examples of how to operate the appliance

Option lists

The \wedge and \vee arrows on the right of the display indicate that choices are available.

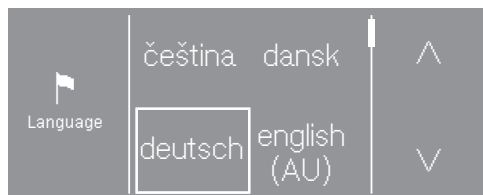

The list scrolls down when the \vee sensor is touched. The list scrolls up when the \wedge sensor is touched.

The scroll bar indicates that further options follow.

The currently selected value is marked with a frame.

Touch the required value to select it.

Easy selection

If there are no arrows, the selection is limited to the displayed values.

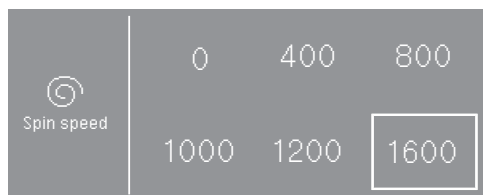

The currently selected value is marked with a frame.

Touch the required value to select it.

Setting numerical values

To change a numerical value, use the \wedge and \vee arrows above or below the numbers you want to change.

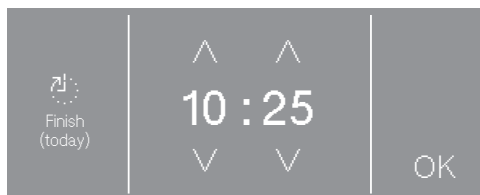

Touch the \wedge and \vee arrows and confirm with the *OK* sensor.

Exiting a sub-menu

Select the Back \leftarrow sensor to exit a sub-menu.

If you select a value in a sub-menu, but do not confirm with *OK*, you can discard this value by touching the \leftarrow sensor.

Before using for the first time

 Damage resulting from incorrect installation and connection. Installing and connecting the washing machine incorrectly will cause serious property damage. See “Installation”.

Emptying the drum

A swivel elbow for the drain hose and/or assembly material may be stored in the drum.

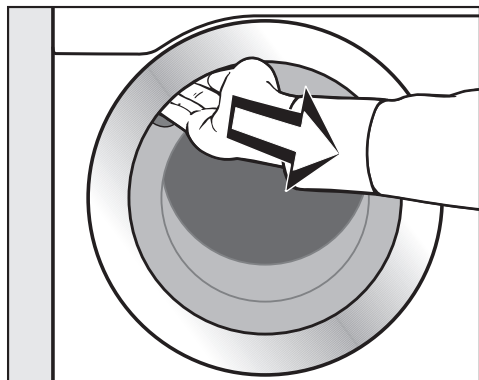

- Pull open the door.
- Remove the swivel elbow and assembly material.
- Shut the door with a gentle swing.

Switching on the washing machine

- Press the  control.

The welcome screen will light up.

When commissioning the washing machine for the first time, you will have to define settings for daily use of the appliance. Some settings can only be configured during the initial commissioning process. After that, they must be changed by Miele Service.

Complete the initial commissioning process.

These settings are also described under “Supervisor level”.



Tip: During initial commissioning, you can go back to the previous screen if you need to correct an entry you have already made.

- Touch the  sensor control to return to the previous screen.

Setting the language

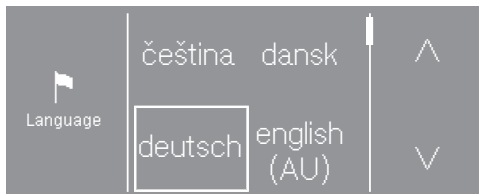
You will be asked to select the language you require for the display. You can change the language at any time (see “Language” under “Supervisor level”).



- Touch the  or  sensor until the language you want appears in the display.
- Touch the sensor for the language you want.

The selected language is marked with a frame and the display will change to next setting.

Before using for the first time

Reference to external appliances

A reference to external hardware appears.

- Confirm with the OK sensor control.

Before initial commissioning, connect the XCI box or adapter or slide a communication module into the slot on the back of the machine. The washing machine must be disconnected from the mains. Then start the commissioning process.

Setting the display brightness

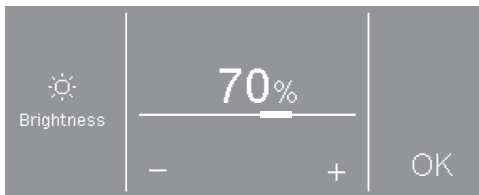

- Set the brightness you want with the – and + sensors and confirm your selection with the OK sensor.

The display will change to the next setting.

Confirm time request



- Touch the yes or no sensor.

If you select yes, the system will skip the Clock display setting.

If you select no, the display will switch to the Clock display setting.

Setting the time of day

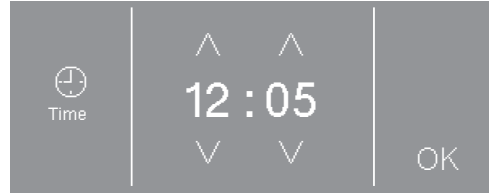

- Use the V and ^ sensors to enter the time and confirm your entry with the OK sensor.

The display will change to the next setting.

Selecting programme packages



- Touch the ^ or V sensor until the programme package you want appears in the display.
- Touch the programme package sensor.

The display shows the associated programmes.

The activated programmes are marked with a frame.

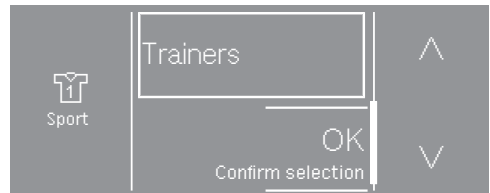

- Touch the sensor for the programmes. The programmes are activated (framed) or deactivated (no frame).
- Confirm with the OK sensor.

Before using for the first time

The display switches back to the programme packages.



- Select other programme packages or confirm your selection with the Continue sensor.

The display will change to the next setting.

Switching on automatic dispensing

Automatic dispensing can be activated via the XCI box or the COM module.

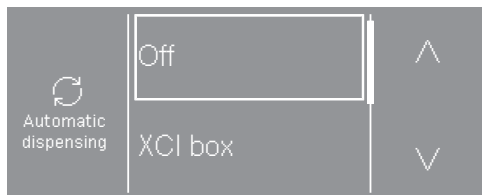

- Touch the \wedge or \vee sensor control until the option you want appears in the display.
- Touch the sensor control for the option.
- If you do not want to switch on automatic dispensing, touch the Off sensor control.

The display will change to the next setting.

Setting up a payment system

If you wish to set up a payment system, read “Payment system” under “Supervisor level”.

If you do not wish to set up a payment system, you can skip this stage.

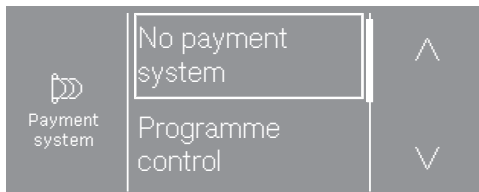

- Touch the No payment system sensor.

The display will change to the next setting.

Select pre-wash water

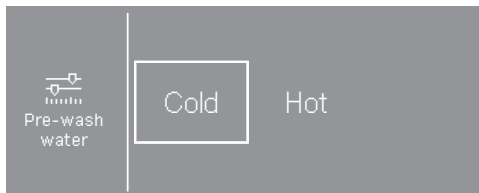

- Touch the cold sensor if the washing machine is only connected to a cold water supply, or touch hot if the washing machine is connected to cold and hot water.

The display will change to the next setting.

Select main wash water

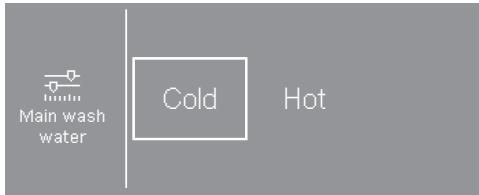

- Touch the **cold** sensor if the washing machine is only connected to a cold water supply, or touch **hot** if the washing machine is connected to cold and hot water.

Further information will appear on the display.

Removing the transport safety device

The display will remind you to remove the transport safety device.

 **Damage resulting from failure to remove the transport safety device.**
Failure to remove the transport safety device can result in damage to the washing machine and to adjacent furniture or appliances.
Remove the transport safety device as described in "Installation".

- Confirm that the transport safety device has been removed with the **OK** sensor control.

To complete the commissioning, start the "Commissioning" programme without laundry appears in the display.

- Confirm the message with the **OK** sensor control.

Completing the commissioning process

To complete commissioning, the commissioning programme must be run without laundry and without detergent.

If the power is interrupted (e.g. if the machine is switched off with the  sensor control), the initial commissioning process can be completed again.

If the commissioning programme has run through to the end, the initial commissioning process does not have to be performed again.

- Open the stopcocks.
- Touch the flashing **Start/Stop** sensor control.
- Once the programme has finished, switch the washing machine off briefly and then switch it back on again.

Initial commissioning is now complete.

Washing environmentally and economically

Energy and water consumption

- To get the most out of your machine, load the maximum dry load size for the wash programme you are using. This will keep the energy and water consumption to a minimum in relation to the size of the load.
- Programmes that are more efficient with regard to energy and water consumption generally have a longer programme running time. By extending the programme running time, the wash temperature that is actually reached can be reduced while still providing the same wash results.

For example, the *ECO 40-60* programme has a longer running time than the *Cottons 40 °C* or *60 °C* programme. The *ECO 40-60* programme is more efficient in terms of energy and water consumption.

- Use the *Express* programme for small, lightly soiled loads.
- Modern detergents make it possible to wash laundry at lower temperatures (e.g. 20 °C). Using lower temperature settings will save energy.
- Washing at low temperatures and/or using liquid detergents can cause bacteria and odours to build up in the washing machine. To maintain the hygiene of the washing machine, carry out a hot wash above 60 °C at regular intervals.

Detergent consumption

- Do not exceed the amounts of detergent recommended by the manufacturer on the packaging.
- Adjust the dispensing to the degree of soiling of the laundry.
- Reduce the amount of detergent with smaller load sizes (approx. 1/3 less detergent than the amount recommended can be used when washing a half load).

Information about subsequent tumble drying

The spin speed selected affects the residual moisture in the laundry and the sound emissions of the washing machine.

The higher the spin speed, the lower the residual moisture in the laundry. However, the sound emissions of the washing machine will increase.

Select the highest possible spin speed for the wash programme to save energy in the subsequent tumble dryer cycle.

1. Preparing the laundry

Emptying pockets

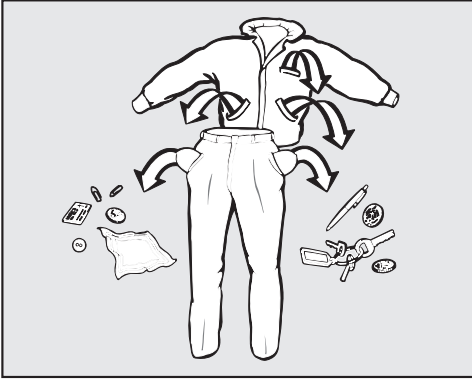

- Empty all pockets.

⚠ Risk of damage due to foreign objects. Nails, coins, paper clips, and so on can cause damage to garments and components in the machine. Check the laundry before washing and remove any foreign objects.

Sorting the laundry

- Sort the laundry according to colour and the garment care label.

Pre-treating stains

- Badly soiled areas and stains should be cleaned as soon as possible. Spillages should be carefully dabbed off using a soft, colourfast cloth.

⚠ Risk of damage due to solvent-based detergents. Detergents containing benzene, stain remover, etc., can damage plastic parts. When pre-treating textiles, make sure that any plastic parts do not come into contact with the detergent.

⚠ Risk of explosion due to solvent-based detergents.

When using solvent-based detergents, an explosive mixture may develop.

Never use solvent-based detergents in the washing machine.

General tips

- Do not machine wash items which are specified by the manufacturer as **not washable** on the care label (☒).
- Curtains: remove rollers and lead weights or place in a laundry bag.
- Sew in or remove any loose underwiring in bras.
- Turn garments inside out, if recommended by the manufacturer.
- Zip up or close any jackets with Velcro or hook and eye fastenings before washing.
- Fasten duvet covers and pillow cases to prevent small items from becoming rolled up inside them.
- Please refer to the Programme chart for more tips and tricks.

2. Loading the washing machine

Opening the door

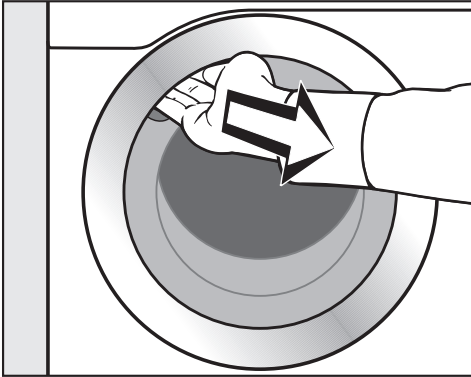

- Reach under the door grip and pull the door open.

Check the drum for foreign objects before loading it with laundry.

- Unfold the laundry and load loosely into the drum.

Mixing both large and small items gives better wash results and also helps to distribute the load evenly during spinning.

The most efficient use of energy and water is achieved when a full load is washed. However, do not overload as this reduces cleaning efficiency and causes creasing.

Closing the door

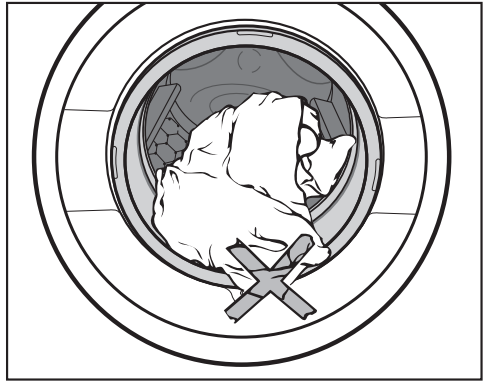

- Make sure that no items are caught between the door and the seal.

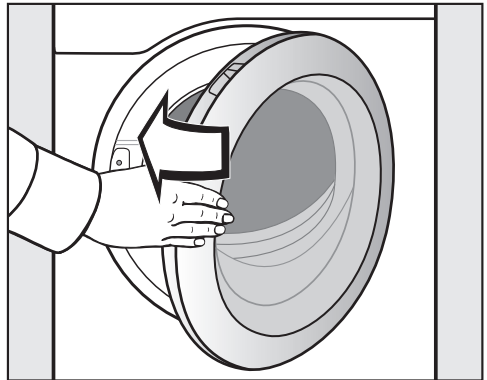

- Shut the door with a gentle swing.

3. Selecting a programme

Switching on the washing machine

- Press the  control.

The drum lighting will come on.

The drum lighting will go out automatically after 5 minutes or when the programme starts.

Selecting a programme

Selecting standard programmes with the programme selector

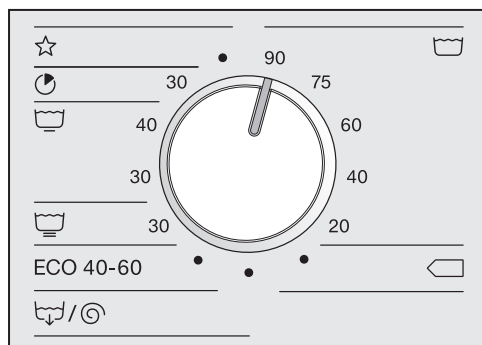

- Turn the programme selector to the required programme.

The selected programme will be shown in the display. The display will then change to the standard menu for that programme.

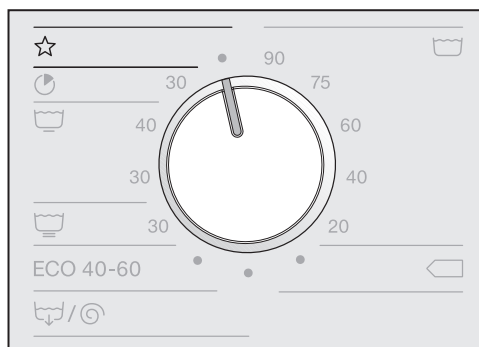

Selecting special programmes via the programme selector position

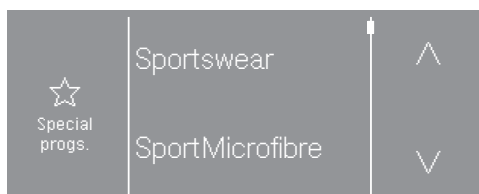

- Turn the programme selector to the  position.

You can select the required programme via the display.



- Touch the  or  sensor control until the programme you want appears in the display.
- Touch the sensor control for that programme.

The display will change to the standard menu for that programme.

4. Selecting programme settings

Selecting the temperature

You can alter the preset temperature of certain programmes.

- Touch the *Temperature*  sensor.

The following will appear in the display:

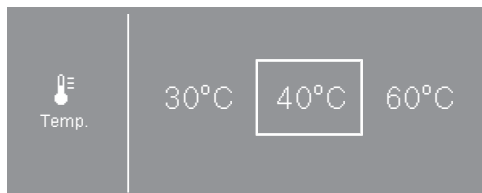

- Select the desired temperature.

The selected temperature is marked with a frame.

Selecting the spin speed

You can alter the preset spin speed.

- Touch the *Spin speed*  sensor.

The following will appear in the display:

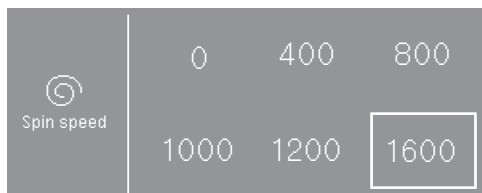

- Select the spin speed you want.

The selected spin speed is marked with a frame.

Selecting extra options

You can select Extras for a wash programme.

For some programmes, an Extra is offered directly in the main menu.

- Touch the sensor of the Extra to activate it.

For some programmes, you select Extras in the *Extras* sub-menu.

- Touch the *Extras*  sensor.

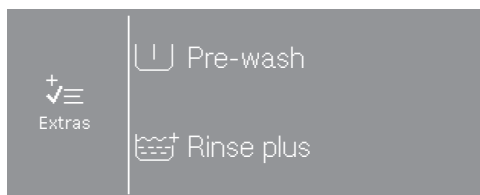

- Select one or two of the available Extras in succession.

Not all extras options can be selected with every programme. If an Extra is not listed, it is not permitted for use with the wash programme in question.

Selecting further options

You can select a delay start period or change the settings of the washing machine.

- Touch the *Further choices*  sensor control.

The following will appear in the display:

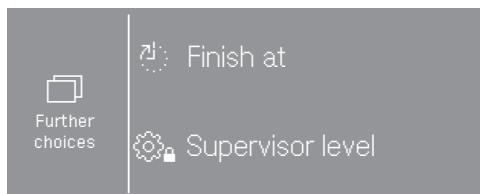

- Select the option you want.

The display will change to the sub-menu for that option.

Delay start is not possible for some programmes.

5. Adding detergent

There are several options for adding detergent to the washing machine.

Detergent drawer

You can use any detergent that is suitable for washing machines.

Detergent dispensing

Please follow the detergent manufacturer's instructions in relation to dosage.

Adding too much detergent will lead to excessive foaming.
Avoid adding excess detergent.

The amount to dispense will depend on:

- the amount of laundry
- the amount of soiling in the laundry
- the water hardness

Hardness range	Hardness in mmol/l	Degree of German hardness °dH
I (soft)	0-1.5	0-8.4
II (medium)	1.5-2.5	8.4-14
III (hard)	above 2.5	above 14

Check with your local water supplier if you do not know the water hardness in your area.

Adding detergent

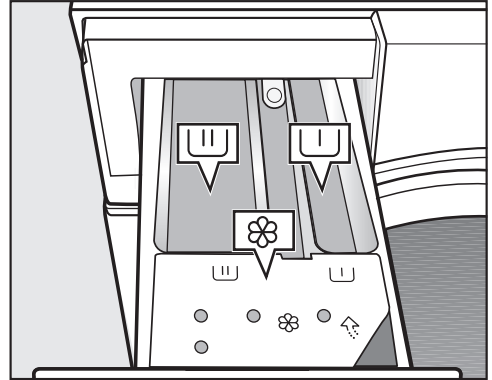

- Pull out the detergent drawer and add detergent to the compartments.

- U Detergent for the pre-wash (divide the total recommended amount as follows: $\frac{1}{3}$ to compartment U and $\frac{2}{3}$ to compartment U)
- U Detergent for the main wash
- ⊗ Fabric conditioner or liquid starch

For disinfection programmes, the U and U compartments can be filled with detergent for the main wash if you have not selected pre-wash.

5. Adding detergent

Adding fabric conditioner or liquid starch separately

- Select the *Separate rinse* programme.
- Change the spin speed if necessary.

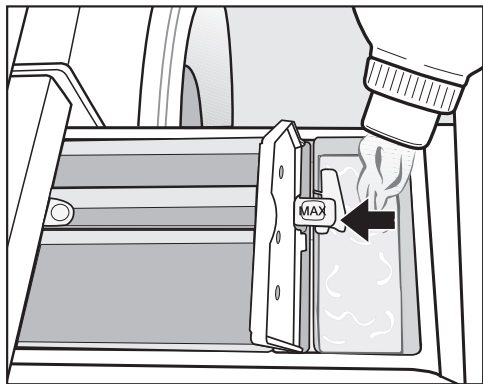

- Add fabric conditioner or liquid starch to the ☼ compartment. **Do not exceed the maximum level mark.**
- Touch the *Start/Stop* sensor.

It will be automatically dispensed in the final rinse. At the end of the wash programme a small amount of water remains in the ☼ compartment.

Adding starch separately

- Prepare the starch solution in accordance with the manufacturer's instructions on the packaging.
- Select the *Starch* programme.
- Add the prepared starch to compartment ☼.
- Touch the *Start/Stop* sensor.

Tip: If starching separately or automatically, thoroughly clean the dispenser compartment, especially the siphon tube, regularly.

Dye removers and dyes

⚠ Damage due to colour run/dye removers.

Colour run and dye removers can cause corrosion in the washing machine.

Do not use colour run or dye removers in this washing machine.

Only use dyes suitable for use in a washing machine. The manufacturer's instructions on the packaging must be observed.

External dispensing

The washing machine is pre-equipped for connecting to external detergent dispensing systems. A separate conversion kit for external dispensing systems is required. This must be fitted by Miele Service or by a Miele Service dealer.

6. Starting the programme – the end of the programme

Payment system

If your machine is connected to a payment system, the amount of payment required will appear in the display.

Do not cancel the programme once it has started. Depending on the settings, money may be lost in the payment system.

Starting the programme

The programme can be started as soon as the *Start/Stop* sensor is flashing on and off.

- Touch the *Start/Stop* sensor.

The door will lock (🔒 symbol) and the programme will start.

If a delay start period has been selected, this will appear in the display.

Once the delay start period has elapsed (if applied), the programme duration will appear in the display; otherwise, the duration will appear straight away. The programme sequence is also shown in the display.

Tip: Touch the **i** sensor to display the set temperature, spin speed and any set Extras.

End of programme

The door remains locked during the anti-crease phase. However, the washing machine door can be unlocked at any time by touching the *Start/Stop* sensor.

Unloading the drum

- Pull open the door.
- Remove the laundry.

Items left in the drum could discolour other items in the next wash or become discoloured themselves. Remove all items from the drum.

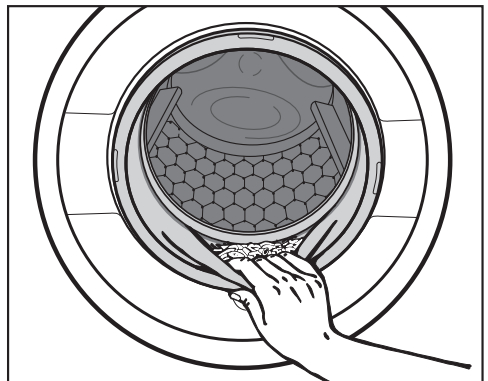

- Check the door seal for any foreign objects.

Tip: Leave the door slightly open to allow the drum to dry.





- Switch the washing machine off with the **⏻** button.

Tip: Leave the detergent drawer slightly open to allow it to dry.

Delay start

The Delay start function can be used to set the time until the programme starts or the programme finish time (see “Delay start” under “Supervisor level”).

Selecting the Delay start function

- Touch the *Further choices*  sensor control.
- Select the Finish at , Start at  or Start in  option.
- Use the \wedge and \vee sensors to enter the hours and minutes and confirm your entry with the *OK* sensor.

The minutes entry moves to the next “full quarter of an hour” and can then be adjusted in 15-minute increments.

Starting Delay start

- Touch the *Start/Stop* sensor.

The door will lock and the time until the programme starts will appear in the display.

Cancelling or changing Delay start

- Touch the *Start/Stop* sensor.

The following will appear in the display:

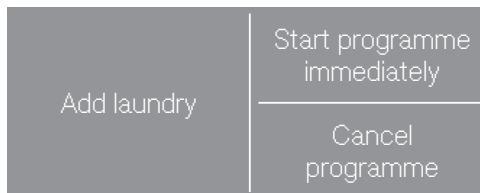

- Touch the Start programme immediately sensor.













The wash programmes starts immediately.

or

- Touch the Cancel programme sensor.





The programme start is cancelled and the *Start/Stop* button flashes on and off.

Standard programmes



 Cottons		20 °C to 90 °C	Max. load 7.0 kg
Use for	Cotton, linen and mixed fibre textiles		
Tip	<ul style="list-style-type: none"> - Select the temperature according to the instructions on the care label, the detergent, the type of soiling and the hygiene requirements. - 20 °C programme for lightly soiled cotton garments. 		
1600 rpm	Extras: Pre-wash 	Rinses: 1–5*	
 Cottons		 / 	Max. load 7.0 kg
Items	Normally soiled cotton garments		
Tip	<ul style="list-style-type: none"> - These settings are the most efficient in terms of energy and water consumption for washing cottons. - With , the wash temperature reached is below 60 °C. 		
1600 rpm	Extras: Pre-wash 	Rinses: 2	
The test programme conforms to EN 60456 and energy labelling to Directive 1061/2010.			
 Express		30 °C	Max. load 3.5 kg
Use for	Cotton garments that have hardly been worn or are only very lightly soiled		
1400 rpm	Extras: Rinse plus 	Rinses: 1	
 Minimum iron		30 °C to 40 °C	Max. load 3.5 kg
Use for	Synthetic and mixed fibre textiles and easy care cotton		
Tip	- Reduce the spin speed for fabric that creases easily.		
1200 rpm	Extras: Pre-wash  , Pre-ironing 	Rinses: 2–4*	

* You can alter the number of rinses carried out via the Supervisor level.





Programme chart

 Delicates		30 °C	Max. load 2.5 kg
Use for	Delicate garments made from synthetic fibre, mixed fibre and viscose		
Tip	- Deselect the spin speed for fabric that creases easily.		
600 rpm	Extras: Pre-wash  , Pre-ironing 	Rinses: 2	
ECO 40-60		Max. load 7.0 kg	
Items	Normally soiled cotton garments		
Tip	<ul style="list-style-type: none"> - A laundry load consisting of mixed cottons that are intended for washing at 40 °C or 60 °C can be washed in the same wash cycle. - This programme is the most efficient in terms of energy and water consumption for washing cottons. 		
1600 rpm		Rinses: 2	
 Drain/Spin		Max. load 7.0 kg	
Tip	<ul style="list-style-type: none"> - Make sure you select the appropriate spin speed. - Select the <i>Rinse plus</i> Extra for an additional rinse. - Drain only: select 0 rpm for the spin speed. 		
1600 rpm	Extras: Rinse plus 		

Special programmes

Towelling		40 °C to 60 °C	Max. load 7.0 kg
Use for	Towels and bathrobes made from terrycloth		
Tip	- Use a colour detergent for dark textiles.		
1400 rpm	Extras: Pre-wash 	Rinses: 2	
Shirts		20 °C to 60 °C	Max. load 2.5 kg
Use for	Shirts and blouses		
Tip	<ul style="list-style-type: none"> - Pre-treat collars and cuffs depending on the level of soiling. - Wash silk shirts and blouses in the <i>Silks</i> programme. - Reduce the maximum load quantity by half if you have selected the <i>Pre-ironing Extra</i>. 		
800 rpm	Extras: Pre-ironing 	Rinses: 2	
Dark garments		30 °C to 60 °C	Max. load 3.5 kg
Use for	Black and dark items made of cotton or mixed fibres		
Tip	- Wash inside out.		
1000 rpm		Rinses: 3	
Denim		30 °C to 60 °C	Max. load 3.5 kg
Use for	Denim shirts, blouses, trousers and jackets		
Tip	<ul style="list-style-type: none"> - Wash denim inside-out. - Denim often contains excess dye and may run during the first few washes. Wash light and dark coloured items separately. 		
1000 rpm		Rinses: 3	
Woollens		Cold to 30 °C	Max. load 2.5 kg
Use for	Machine-washable woollens and woollen blends		
Tip	- Use detergent formulated for woollens.		
1200 rpm		Rinses: 2	
Cottons PRO		60 °C	Max. load 7.0 kg
Use for	Mixed fibre textiles (50 % cotton and 50 % polyester)		
Tip	- Extra energy-efficient wash programme for commercial cotton or cotton/synthetic blend textiles with normal levels of soiling, e.g. workwear.		
1400 rpm	Extras: Pre-wash 	Rinses: 2	





Programme chart

Silks		Cold to 30 °C	Max. load 2.5 kg
Use for	Silks and all hand-washable textiles which do not contain wool		
Tip	<ul style="list-style-type: none"> - Follow the instructions on the care label. - Place tights, bras etc. in a laundry bag. 		
600 rpm	Extras: Rinse plus 	Rinses: 2	
Separate rinse		Max. load 7.0 kg	
Use for	Items which only need to be rinsed and spun		
Tip	- Observe the spin speed for items which crease easily.		
1400 rpm	Extras: Rinse plus 	Rinses: 2	
Starch		Cold to 40 °C	Max. load 3.5 kg
Use for	Table cloths, serviettes and workwear that need starching		
Tip	<ul style="list-style-type: none"> - Laundry that is to be starched should be washed but not treated with fabric conditioner. - Observe the spin speed for items which crease easily. 		
1400 rpm		Rinses: 1	
Clean machine 70 °C		No load	
	For cleaning the suds container and the drainage system. <ul style="list-style-type: none"> - Add universal detergent to the  compartment. - Use the <i>Clean machine</i> programme regularly if you frequently use disinfection programmes. 		
Maintenance wash hygiene		No load	
	For cleaning the suds container and the drainage system. <ul style="list-style-type: none"> - If a programme at a temperature below 60 °C has been used, a request to start the <i>Maintenance wash hygiene</i> programme appears in the display. The <i>Hygiene</i> setting must be switched on for this purpose (see “Supervisor level”). - Add universal detergent to the  compartment. 		

Programme packages





You can select various programmes packages. The programmes selected from the programme packages are displayed under the *Special programmes* list.

Sport

Sportswear		30 °C to 60 °C	Max. load 3.0 kg
Use for	Sports and leisure wear, such as shirts and trousers made from synthetic fibres or mixed blends		
Tip	<ul style="list-style-type: none"> - Do not use fabric conditioner. - Observe the instructions on the care label. 		
1000 rpm	Extras: Pre-wash 	Rinses: 2	
SportMicrofibre		30 °C to 60 °C	Max. load 3.0 kg
Use for	Clothing for sports and fitness such as tops, trousers and base layers made from microfibre		
Tip	<ul style="list-style-type: none"> - Do not use fabric conditioner. - Observe the instructions on the care label. 		
800 rpm	Extras: Rinse plus 	Rinses: 2	
Trainers		30 °C to 60 °C	Max. 2 pairs
Use for	Trainers (no leather shoes), shin pads, elbow protectors and similar items		
Tip	<ul style="list-style-type: none"> - Do not use fabric conditioner. - Coarse soiling should be brushed off first. - Observe the instructions on the care label. - Use the dryer basket for tumble drying. - Close Velcro fasteners. 		
400 rpm	Extras: Pre-wash  , Pre-rinse 	Rinses: 3	



Programme chart

Outerwear

Down-filled items		30 °C to 60 °C	Maximum of 1 article
Use for	Outdoor jackets, sleeping bags, pillows and other down-filled items		
Tip	<ul style="list-style-type: none"> - Do not use fabric conditioner. - Remove any air before washing. To do this, either push the items into a narrow laundry bag to compress them or tie the items together with a washable strap. - Observe the instructions on the care label. - The items are spun after wetting to remove any air. 		
1400 rpm	Extra options: Pre-wash  , Rinse plus 	Rinses: 2	
Outerwear		Cold to 40 °C	Max. load 3.0 kg
Use for	Performance outerwear (e.g. outdoor jackets and trousers) made from membrane fabrics such as Gore-Tex®, SYMPATEX®, WIND-STOPPER® etc.		
Tip	<ul style="list-style-type: none"> - Zip up or close any Velcro fasteners before washing. - Do not use fabric conditioner. - To maintain the water repellency of the textiles, it may be necessary to proof them again after washing. Select the <i>Proofing</i> programme for this purpose. - Wash down-filled items with the <i>Down filled items</i> programme. 		
1000 rpm	Extra options: Pre-wash  , Rinse plus 	Rinses: 2	
Proofing		30 °C to 40 °C	Max. load 3.0 kg
Use for	To refresh the proofing of water-repellent textiles, e.g. rainwear, ski wear or other textiles.		
Tip	<ul style="list-style-type: none"> - Add proofing agent to the  compartment. - The items should be freshly laundered and spun or dried before proofing. - To achieve an optimum effect, apply a thermal treatment to the articles by drying in a tumble dryer or ironing. 		
800 rpm		Rinses: 1	





Programme chart

Wellness/Hair salons

Towels		40 °C	Max. load 5.5 kg
Use for	Lightly soiled cotton towelling		
Tip	- Use a colour detergent for dark textiles.		
1400 rpm		Rinses: 2	
Towels plus		40 °C to 80 °C	Max. load 5.5 kg
Use for	Heavily soiled cotton towelling		
Tip	- Use a colour detergent for dark textiles.		
1400 rpm	Extras: Pre-wash 	Rinses: 2	
Capes		Cold to 30 °C	Max. load 2.0 kg
Use for	Lightly soiled hairdressers' capes made from synthetic fibres		
Tip	- Select the <i>Rinse plus</i> extra option for extra good wash results		
600 rpm	Extras: Rinse plus 	Rinses: 2	





Programme chart

Hotels

Bed linen		40 °C to 90 °C	Max. load 7.0 kg
Use for	Cotton or mixed fibre bed linen		
Tip	<ul style="list-style-type: none"> - The items are always soaked after the start. - Use a colour detergent for coloured textiles. 		
1200 rpm	Extras: Pre-wash  , Pre-ironing 	Rinses: 2	
Table linen		40 °C to 75 °C	Max. load 3.5 kg
Use for	Tablecloths and serviettes made from cotton, linen and mixed fibres		
Tip	<ul style="list-style-type: none"> - Select Pre-wash for stubborn stains. Use detergent with enzymes for the pre-wash. - The items are always soaked after the start. 		
1200 rpm	Extras: Pre-wash  , Pre-ironing 	Rinses: 2	
Kitchen linen		60 °C to 85 °C	Max. load 7.0 kg
Use for	Cotton or linen kitchen linen, e.g. chef's jackets and trousers, chef's hats, cleaning cloths		
Tip	<ul style="list-style-type: none"> - Select Pre-wash for stubborn stains. Use detergent with enzymes for the pre-wash. - The pre-wash cycle removes any coarse soiling. 		
1400 rpm	Extras: Pre-wash 	Rinses: 3	

Programme chart





Home textiles

Lightweight curtains		Cold to 40 °C	Max. load 3.5 kg
Use for	Curtains specified as machine-washable by the manufacturer		
Tip	- For curtains which crease easily, deselect the spin function.		
600 rpm	Extras: Pre-wash  , Rinse plus 	Rinses: 2	
Down bedding		40 °C to 75 °C	1 duvet or 1–2 pillows*
Use for	Down-filled pillows and duvets		
Tip	<ul style="list-style-type: none"> - Remove any air before washing. To do this, either push the items into a narrow laundry bag to compress them or tie the items together with a washable strap. - Follow the instructions on the care label. - The items are spun after wetting to remove any air. 		
1400 rpm	Extra options: Rinse plus 	Rinses: 2	
Synthetic bedding		40 °C to 75 °C	Max. 7.0 kg or 1 duvet or 1–2 pillows*
Use for	Bed linen made from microfibre, pillows and duvets with a synthetic filling		
Tip	<ul style="list-style-type: none"> - Follow the instructions on the care label. - Use liquid detergent. 		
800 rpm	Extras: Pre-wash  , Rinse plus 	Rinses: 2	

* 1 pillow (80 x 80 cm) or 2 pillows (40 x 80 cm)









Programme chart

Workwear

Oil/fat special		60 °C to 90 °C	Max. load 7.0 kg
Use for	Work coats, jackets, hats, cleaning cloths made from cotton or mixed fibres		
Tip	<ul style="list-style-type: none"> - Activate Pre-wash for heavy contamination. - Use liquid detergent. 		
1400 rpm	Extras: Pre-wash 	Rinses: 3	
Dust/Flour special		40 °C to 90 °C	Max. load 7.0 kg
Use for	Cotton or mixed fibre workwear, table cloths or cleaning cloths soiled with dust or flour		
Tip	<ul style="list-style-type: none"> - The automatic pre-rinse removes any coarse soiling. Add a second pre-rinse for very heavy levels of soiling. - Select Pre-wash for stubborn stains. 		
1400 rpm	Extras: Pre-wash  , Pre-rinse 	Rinses: 3	
Intensive wash		40 °C to 90 °C	Max. load 7.0 kg
Use for	Heavily soiled workwear made from cotton, linen and mixed fibres		
Tip	- You can achieve particularly good wash and rinse results with a high water level.		
1400 rpm	Extras: Pre-wash 	Rinses: 2	

Programme chart

Disinfection I

 Disinfection		85 °C / 15 min	Max. load 7.0 kg
Items	Cotton or mixed fibre textiles		
Tip	<ul style="list-style-type: none"> - Thermal disinfection with a 15-minute holding time at 85 °C. - A second disinfection rinse can be activated via the Supervisor level. - No water inlet via the fabric conditioner compartment 		
1400 rpm	Extras: Pre-wash  , Rinse plus 	Rinse cycles: 2	
 Disinfection		60 °C/20 min	Max. load 7.0 kg
Use for	Workwear or disinfection clothing, sorted by colour, provided the items are suitable for disinfection.		
Tip	<ul style="list-style-type: none"> - Chemo-thermal disinfection with a 20-minute holding time at 60 °C. - A second disinfection rinse can be activated via the Supervisor level. - No water inlet via the fabric conditioner compartment. 		
1400 rpm	Extras: Pre-wash  , Rinse plus 	Rinses: 2	
 Disinfection		40 °C/20 min	Max. load 7.0 kg
Use for	Workwear or disinfection clothing, sorted by colour, provided the items are suitable for disinfection.		
Tip	<ul style="list-style-type: none"> - Chemo-thermal disinfection with a 20-minute holding time at 40 °C. - No water inlet via the fabric conditioner compartment. - An extra gentle wash rhythm allows you to wash even more sensitive textiles. 		
1400 rpm	Extras: Pre-wash  , Rinse plus 	Rinses: 2	

Extras

You can add Extras to the wash programmes.

Not all Extras can be selected with every programme. If an Extra is not listed, it is not permitted for use with the wash programme in question.

Selecting Extras

For some programmes, an Extra is offered directly in the main menu.

- Touch the sensor of the Extra to activate it.

For some programmes, you select Extras in the *Extras* sub-menu.

- Touch the *Extras*  sensor.
- Select one or two of the Extras available.

Pre-wash





A Pre-wash can be added for heavily soiled laundry. Coarse soiling is loosened and removed before the main wash.

Pre-rinse

The laundry is rinsed before the main wash to remove larger quantities of soiling, e.g. dust, sand.

Pre-ironing

In order to reduce creasing, the laundry undergoes a smoothing process at the end of the programme. Reducing the maximum load by 50 % will achieve a better result. Small loads achieve a better result.

The textiles must be suitable for drying in a tumble dryer   and suitable for ironing  .

Rinse plus

An extra rinse can be activated to achieve a better wash result.

Special features in the programme sequence

Spinning

Final spin speed

When a programme is selected, the maximum spin speed for this wash programme is shown in the display.

You can reduce the final spin speed.

However, you cannot select a final spin speed higher than that shown in the chart.

Interim spin

There is a spin cycle after the main wash and between the rinses. A reduction in the final spin speed will also reduce the interim spin speed as appropriate.

Omitting the interim spin and the final spin

- Select the programme setting *Spin speed 0*.

After the last rinse, the water will be pumped away and the anti-crease phase will switch on.

Anti-crease

At the end of the programme, the drum continues to turn at intervals for up to 30 minutes to help prevent creasing. The washing machine can be opened at any time.

There is no anti-crease phase at the end of some programmes.
--

Changing the programme sequence

A programme cannot be cancelled or changed when operating a payment system.

If the washing machine is switched off during active programme operation, the standby function does not switch the washing machine off completely after 15 minutes. Safety functions continue to be active because there may still be water inside the drum.

Changing a programme

After the start of a programme, it is no longer possible to select a different programme.

You will need to cancel the current programme before you can select a new one.

Programme cannot be changed appears in the display if the programme selector has been moved. The text disappears when the programme selector is set to the original programme.

Cancelling a programme

You can cancel a wash programme at any time after it has started.

Disinfection programmes can only be cancelled with a PIN code.

- Touch the *Start/Stop* sensor.
- Select *Cancel programme*.

The suds will be pumped away. The programme is cancelled. The door lock is released.

- Pull open the door.
- Remove the laundry.

If you want to select a different programme:

- Close the door.
- Select the programme you want.
- Add detergent to the detergent dispenser drawer, if necessary.
- Touch the *Start/Stop* sensor.

The new programme will begin.

Switching on the washing machine after an interruption to the power supply

If the washing machine is switched off with the ① button during a wash programme, the programme will be interrupted.

- Switch the washing machine back on with the ① button.
- Note the message in the display.
- Touch the *Start/Stop* sensor.

The programme will also be interrupted if power is interrupted by a power cut.

- When power is resumed, confirm the message in the display with *OK*.
- Touch the *Start/Stop* sensor.

The programme continues.

Changing the programme sequence

Adding or removing laundry

You can add or remove items during the first few minutes after the programme has started.

- Touch the *Start/Stop* sensor.

The following will appear in the display:

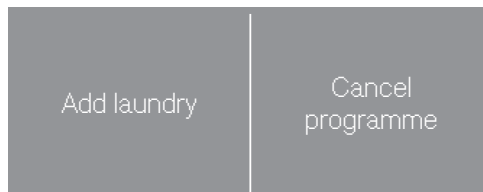

- Touch the *Add laundry* sensor.

The programme will stop and the door will unlock.

 Risk of chemical burns from detergent.

When adding or removing laundry, your skin may come into contact with detergent, particularly if the detergent is dispensed externally.

Take care when placing your hands inside the drum.

If suds have come into contact with the skin, rinse off immediately with plenty of lukewarm water.

- Pull open the door.
- Add laundry or remove individual items.
- Close the door.
- Touch the *Start/Stop* sensor.

The programme will continue.

Once a programme has started successfully, the washing machine cannot recognise any adjustment to the load.

For this reason, if laundry is added or removed after the start of a programme, the machine will always complete the programme cycle assuming a full load.

The door cannot be opened, if:

- The suds temperature is above 55 °C.

The safety lock will remain activated if the temperature in the drum is above 55 °C. The lock will not deactivate until the temperature has dropped to below 55 °C.



Detergent

The correct detergent

You can use any detergent that is suitable for washing machines. Instructions for use and recommended amounts are given on the detergent packaging.

Recommended detergents in accordance with Directive (EU) No. 1015/2010

The recommendations apply to the temperature ranges given in the section “Programme chart”.

	Universal	Colour	Delicates and woollens	Special
	detergent			
Cottons	✓	✓	–	–
Express	–	✓ ¹	–	–
Minimum iron	–	✓	–	–
Delicates	–	–	✓	–
ECO 40-60	✓	✓	–	–
Towelling	✓	✓ ¹	–	–
Shirts	✓	✓	–	–
Dark garments	–	✓ ¹	–	–
Denim	–	✓ ¹	–	–
Intensive wash	✓	✓	–	✓
Woollens 	–	–	✓	✓
Silks 	–	–	–	✓
Pillows	–	–	✓ ¹	✓

✓ Recommended

– Not recommended

¹ Liquid detergent

⚠ Risk of electric shock.

Only ever perform cleaning and maintenance work when the appliance is disconnected from the power.

Disconnect the washing machine from the mains electricity supply.

Cleaning the casing and fascia panel

⚠ Damage caused by detergents.

Solvent-based cleaning agents, abrasive cleaners, glass cleaners or multi-purpose cleaning agents can cause damage to plastic surfaces and other parts.

Do not use any of these cleaning agents.

⚠ Risk of damage due to ingress of water.

The pressure of a water jet can cause water to get into the washing machine, resulting in damage to components.

Do not spray the washing machine with a water jet.

- Clean the casing and fascia panel with a mild cleaning agent or soap and water and dry both with a soft cloth.
- The drum and any other stainless steel components can be cleaned using a suitable stainless-steel cleaning agent.

Cleaning the detergent drawer

Washing at low temperatures and the use of liquid detergent can lead to a build-up of mould and bacteria in the detergent drawer.

- For hygiene reasons, clean the entire detergent drawer at regular intervals.

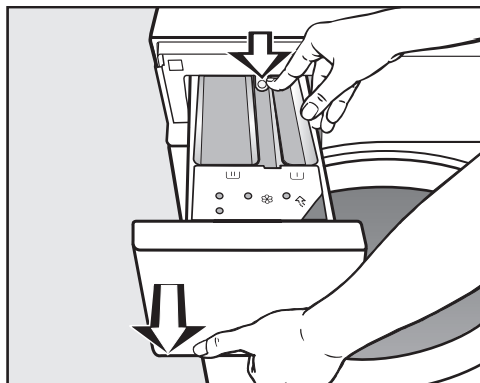

- Pull out the detergent drawer until resistance is felt. Press down the release button and at the same time pull the drawer right out of the machine.
- Clean the detergent drawer with warm water.

Cleaning and care

Cleaning the siphon and the channel

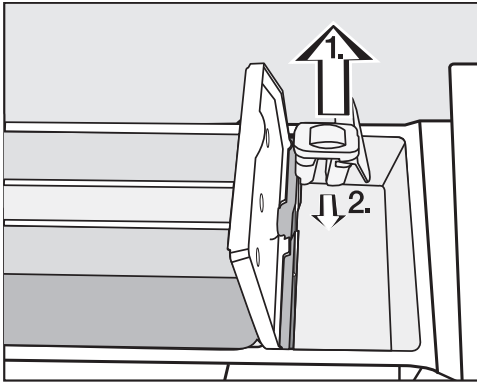

- Pull the siphon out of the  compartment .
Clean the siphon under warm running water.
- Refit the siphon.
- Clean the fabric conditioner channel using a brush and warm water.

Cleaning the detergent dispenser drawer compartment

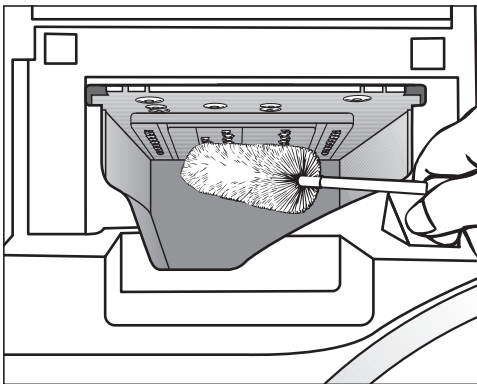

- Use a bottle brush to remove detergent residues and limescale from the jets inside the detergent drawer.
- Replace the detergent drawer.

Tip: Leave the detergent drawer slightly open to allow it to dry.

Cleaning the drum, suds container and drainage system

By using wash programmes with temperatures of 60 °C or higher on a regular basis and using a multi-purpose detergent, you can avoid a build-up of bacteria in the washing machine.

Use the *Maintenance wash* programme regularly, especially if you frequently use wash programmes with low temperatures.

Optimum results can be achieved by using a machine cleaner. Alternatively, a multi-purpose powder detergent can be used.

- Start the *Maintenance wash* programme.
- Dispense the machine cleaner or multi-purpose detergent directly into the drum.
- Do **not** load any laundry. The drum must be empty for the maintenance wash programme.
- At the end of the programme, check the inner drum and remove any coarse residues.

Use the *Maintenance wash* programme regularly if you frequently use disinfection programmes.

Cleaning the sealing ring

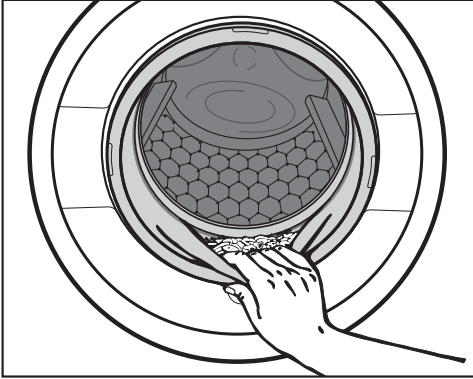

- Check the fold in the sealing ring for foreign objects.
- Clean the sealing ring and the inner fold of the sealing ring with a damp cloth.

Tip: Leave the door slightly open to allow the drum to dry.

Cleaning the water inlet filters

The washing machine has filters to protect the water intake valves. Check these filters every 6 months or so. Perform this check more often if there are frequent interruptions to the external water supply.

Cleaning the filters in the water inlet valves

- Using pliers, carefully loosen the nut on the intake valve and unscrew.

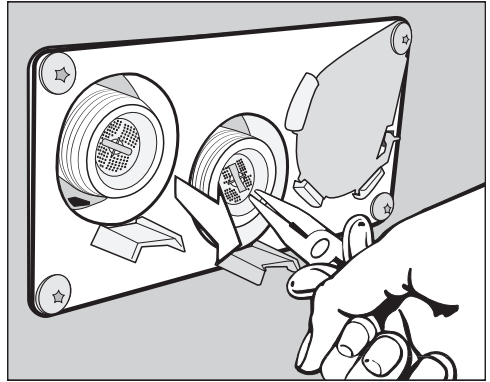

- Use pointed pliers to grip the bar and pull out the filter; then clean the filter. Reassemble in reverse order.

The filters must be put back in place after cleaning.

Problem solving guide





You are able to correct the majority of faults and problems that arise during day-to-day use without external assistance. You can save time and money in many cases, as you do not need to call Miele Service.

The following tables are designed to help you to find the cause of a malfunction or a fault and to resolve it.

The wash programme does not start

Problem	Cause and remedy
The display remains dark, and the <i>Start/Stop</i> sensor control does not light up or flash.	There is no power to the machine. <ul style="list-style-type: none">■ Check whether the washing machine is switched on.■ Check whether the washing machine is connected to the power supply.■ Check whether the main fuse or circuit breaker has tripped.
	The washing machine has switched off automatically to save energy. <ul style="list-style-type: none">■ Switch the washing machine back on with the ① button.
The following appears in the display: i Door will not lock. Call Service.	The door is not closed properly. The door lock could not engage. <ul style="list-style-type: none">■ Close the door again.■ Start the programme again. If the fault message appears again, contact Miele Service.
The programme does not start when <i>Spin</i> has been selected.	You have not yet completed the initial commissioning process. <ul style="list-style-type: none">■ Perform the <i>Initial commissioning process</i> as described in these instructions.
The display is dark and the <i>Start/Stop</i> sensor control is flashing slowly.	The display has switched off automatically to save energy. <ul style="list-style-type: none">■ Touch any of the controls. The display switches back on.

Programme cancellation and error message

Problem	Cause and remedy
 Drainage fault. Clean drain filter and pump. Check the drain hose.	The drain is blocked or restricted. The drain hose has been fixed too high. <ul style="list-style-type: none"> ■ Clean the drain filter and the drain pump. ■ The maximum drain height is 1 m.
 Water intake fault. Open stopcock.	The water inlet is blocked or restricted. <ul style="list-style-type: none"> ■ Check whether the stopcock has been properly opened. ■ Check whether the inlet hose is kinked.
	The water pressure is too low. <ul style="list-style-type: none"> ■ Switch on the Low water pressure setting (see “Low water pressure” under “Supervisor level”).
	The filters in the water inlet are blocked. <ul style="list-style-type: none"> ■ Clean the filters (see “Cleaning the filters” under “Cleaning and care”).
 Waterproof system activated	The water protection system has reacted. <ul style="list-style-type: none"> ■ Close the stopcock. ■ Call Miele Service.
 Disinfection temperature not reached	The required temperature was not reached during the disinfection programme. <ul style="list-style-type: none"> ■ The washing machine has not carried out the disinfection cycle correctly. ■ Start the programme again.
 Fault F . If restart fails, call Service	There is a fault. <ul style="list-style-type: none"> ■ Disconnect the washing machine from the electricity supply. ■ Wait at least 2 minutes before reconnecting the washing machine to the electricity supply. ■ Switch the washing machine on again. ■ Start the programme again. If the fault message appears again, contact Miele Service.

Problem solving guide

A fault message appears in the display¹⁾

Problem	Cause and remedy
i Container empty	One of the external detergent containers is empty. ■ Refill the detergent container.
i Container 1 empty	External detergent container 1 is almost empty. The message can refer to containers 1 to 6. ■ Refill the detergent container. ■ Reset the container's early-warning counter (see “Early-warning counter” under “Supervisor level”)
i Check hot water inlet	The hot water supply is blocked or restricted. ■ Check whether the hot water stopcock has been properly opened. ■ Check whether the inlet hose is kinked.
i Align machine. Laundry not properly spun	The selected spin speed was not reached during the final spin due to excessive imbalance. ■ Check that the washing machine is level. ■ Start the spin cycle again.
i Machine is leaking	The washing machine or drain valve is leaking. ■ Close the stopcock. ■ Call Miele Service.
i Machine can no longer be networked. Please call customer service.	Miele@home is not available. ■ Switch off the washing machine. ■ Switch the washing machine on again. ■ If the message appears again, contact the Miele Customer Service Department. The washing machine can continue to be used. ■ Touch the <i>OK</i> sensor control.



¹ The messages will appear at the end of the programme and when the washing machine is switched on and must be acknowledged with the *OK* sensor control.

An unsatisfactory wash result



Problem	Cause and remedy
<p>Liquid detergent does not give the required result.</p>	<p>Liquid detergents usually contain no bleaching agents. They do not remove fruit, coffee, and tea stains.</p> <ul style="list-style-type: none"> ■ Use a general purpose powder detergent containing a bleaching agent. ■ Pour stain removers into the  drawer in the dispenser compartment and liquid detergent into a dispenser ball. ■ Never put stain removers and liquid detergent together in the dispenser drawer.
<p>White residues which look like powder detergent are seen on dark textiles after washing.</p>	<p>The detergent contained compounds (zeolites) to aid water softening which are not soluble in water. These have ended up on the laundry.</p> <ul style="list-style-type: none"> ■ Try to brush off the residues with a soft brush once the laundry is dry. ■ In future, wash dark textiles using a detergent which contains no zeolites. Liquid detergents usually contain no zeolites.
<p>Textiles with particularly greasy soiling are not properly clean.</p>	<ul style="list-style-type: none"> ■ Select a programme with pre-wash. Use liquid detergent for the pre-wash. ■ Continue to use universal powder detergent for the main wash. <p>The use of heavy-duty detergent is recommended in the main wash for very heavily soiled work clothing. Please seek advice from the detergent manufacturer.</p>
<p>Grey, greasy particles cling to washed laundry.</p>	<p>Insufficient amounts of detergent were used. The laundry was heavily soiled with grease (oils, ointments).</p> <ul style="list-style-type: none"> ■ Use more detergent or use liquid detergent with this type of soiled laundry. ■ Before washing the next load, run a 60 °C programme with liquid detergent but without a load.

Problem solving guide

General problems

Problem	Cause and remedy
The machine shakes during the spin cycle.	The machine feet are not level and not secured. <ul style="list-style-type: none"> ■ Level the machine and adjust the feet correctly.
Strange pump noises can be heard.	This is not a fault. These slurping noises occur at the start and end of a pump sequence as a normal part of the operation.
Large amounts of detergent residue remain in the detergent dispenser drawer.	The water pressure is too low. <ul style="list-style-type: none"> ■ Clean the filters in the water inlet.
	Powder detergent used in conjunction with water softeners tends to become sticky. <ul style="list-style-type: none"> ■ Clean the detergent dispenser drawer and, in future, add detergent into the drawer first, and then add the water softener.
Fabric softener is not completely dispensed or too much water remains in the  compartment.	The siphon tube is not correctly positioned or is clogged. <ul style="list-style-type: none"> ■ Clean the siphon, see “Cleaning and care – Cleaning the detergent dispenser compartment”.
The display is in a different language.	A different language has been selected. <ul style="list-style-type: none"> ■ Switch the washing machine off and on again. <p>The selected operator language appears in the display.</p>
	The operator language has been changed. <ul style="list-style-type: none"> ■ Select the language you require (see “Language” under “Supervisor level”).
The laundry has not been spun properly. The laundry is still wet.	The machine detected a high level of imbalance during the final spin and reduced the spin speed automatically. <ul style="list-style-type: none"> ■ Include both large and small items in the load as this will achieve better distribution.
The drum remains stationary but the programme keeps running.	<ul style="list-style-type: none"> ■ Switch the washing machine off and then back on with the  button. ■ Note the message in the display. ■ Touch the <i>Start/Stop</i> sensor control. <p>The drum continues to spin and the programme continues.</p>

The door will not open

Problem	Cause and remedy
<p>The door cannot be pulled open during a programme.</p>	<p>The door is locked during the wash programme.</p> <ul style="list-style-type: none"> ■ Touch the <i>Start/Stop</i> sensor control. ■ Select Cancel programme or Add laundry. <p>The door will unlock and you will be able to pull it open.</p> <hr/> <p>There is still water in the drum and the machine is unable to drain.</p> <ul style="list-style-type: none"> ■ Clean the drainage system as described under “Opening the door in the event of a blocked drain outlet and/or power cut”.
<p> Programme cancelled appears in the display at the end of a programme or after a programme has been cancelled.</p>	<p>To protect the user against scalding, the door cannot be opened if the suds temperature is higher than 55 °C.</p> <ul style="list-style-type: none"> ■ Wait until the temperature in the drum has decreased and the message has gone out in the display.
<p>The following appears in the display:  Door lock jammed. Call Service.</p>	<p>The door lock has jammed.</p> <ul style="list-style-type: none"> ■ Call Miele Service.

Problem solving guide

Opening the door in the event of a blocked drain outlet and/or power cut



Risk of electric shock.

Only ever perform cleaning and maintenance work when the appliance is disconnected from the power.

Disconnect the washing machine from the mains electricity supply.

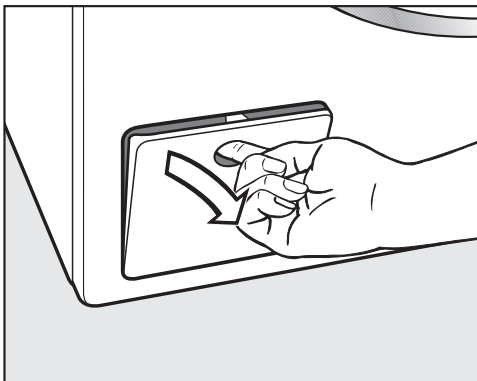

- Open the access panel to the drain system.

Blocked drain outlet

If the drain outlet is blocked, there may be a large quantity of water (max. 30 l) left behind in the washing machine.



Risk of scalding due to hot suds.

Escaping suds will be hot if laundry has been washed at high temperatures.

Carefully allow all suds to drain off.

Emptying the drum

....For machines with a drain pump

- Place a suitable container under the access flap.

Remove the drain filter, though not completely.

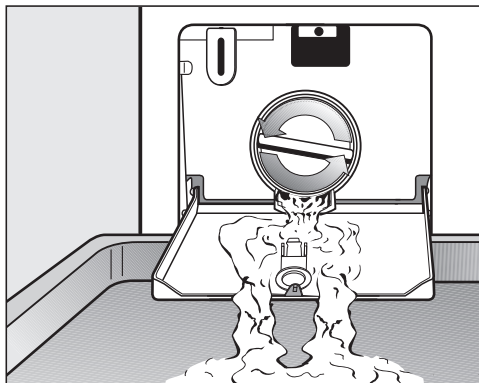

- Slowly unscrew the drain filter to let the water out.
- Tighten the drain filter back up again if you need to interrupt the flow of water.

Cleaning the drain filter

Once the flow of water ceases:

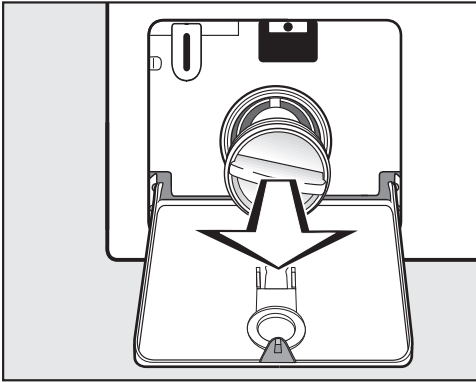

- Remove the drain filter completely.
- Clean the drain filter thoroughly.

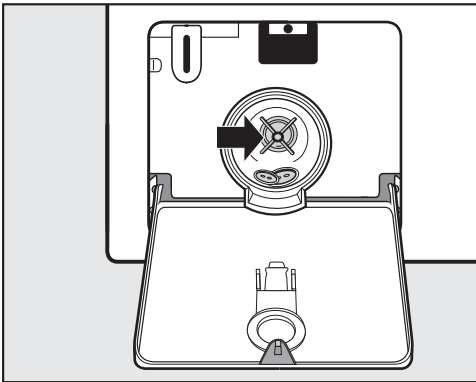

- Check the drain pump impellers to make sure they can rotate freely.
- Remove any foreign objects (e.g. buttons, coins, etc.) and clean the interior.
- Put the drain filter back in place and secure it.

⚠ Water damage.

Water will escape from the machine if you forget to replace the drain filter. Replace the drain filter correctly and tighten it securely.

Opening the door

⚠ Danger of injury due to rotating drum.

Reaching into a moving drum is extremely dangerous.

Always make sure that the drum is stationary before reaching in to remove laundry.

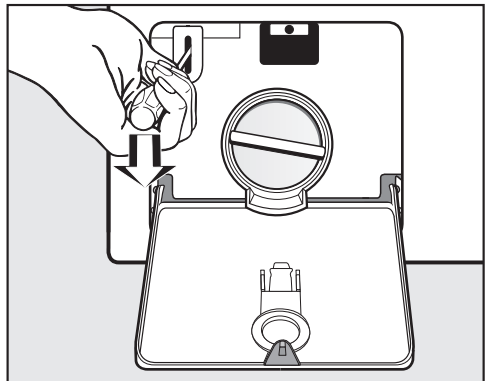

- Use a screwdriver to unlock the door.
- Pull open the door.

Problem solving guide

Emptying the drum

...In machines with a drain valve

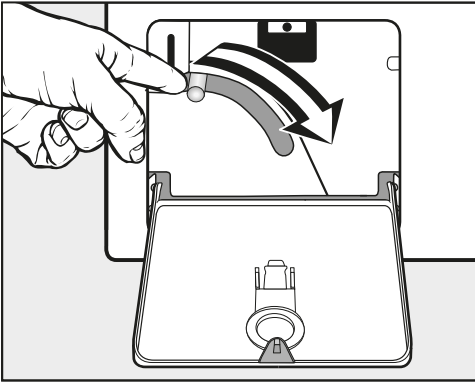

- Push the emergency drain lever downwards and hold until no more water runs out.

Opening the door

 Danger of injury due to rotating drum.

Reaching into a moving drum is extremely dangerous.

Always make sure that the drum is stationary before reaching in to remove laundry.

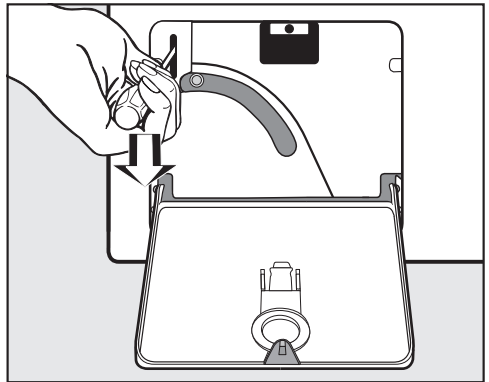

- Use a screwdriver to unlock the door.
- Pull open the door.

Contact in case of malfunction

In the event of any faults which you cannot remedy yourself, please contact your Miele Dealer or Miele Service.

Contact information for Miele Service can be found at the end of this document.

Please quote the model and serial number of your appliance when contacting Miele Service. This information can be found on the data plate.

The data plate is found above the porthole glass when the washing machine door is opened:

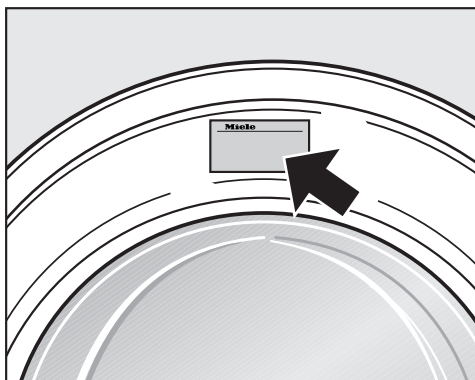

EPREL database

From 1 March 2021, information on energy labelling and ecodesign requirements will be available in the European Product Database (EPREL). You can find the product database at the following link <https://eprel.ec.europa.eu/>. You will be asked to enter the model identifier.

The model identifier can be found on the data plate.

Miele Made in xxx
Mod.: **XXXxxx**
M-Nr.: xxxxxxxx Type: XXxx-X
Nr.:/ xxxxxxxx
Miele Service
www.miele.com/service

Optional accessories

Optional spare parts and accessories for this washing machine are available from Miele.

Installation

Front view

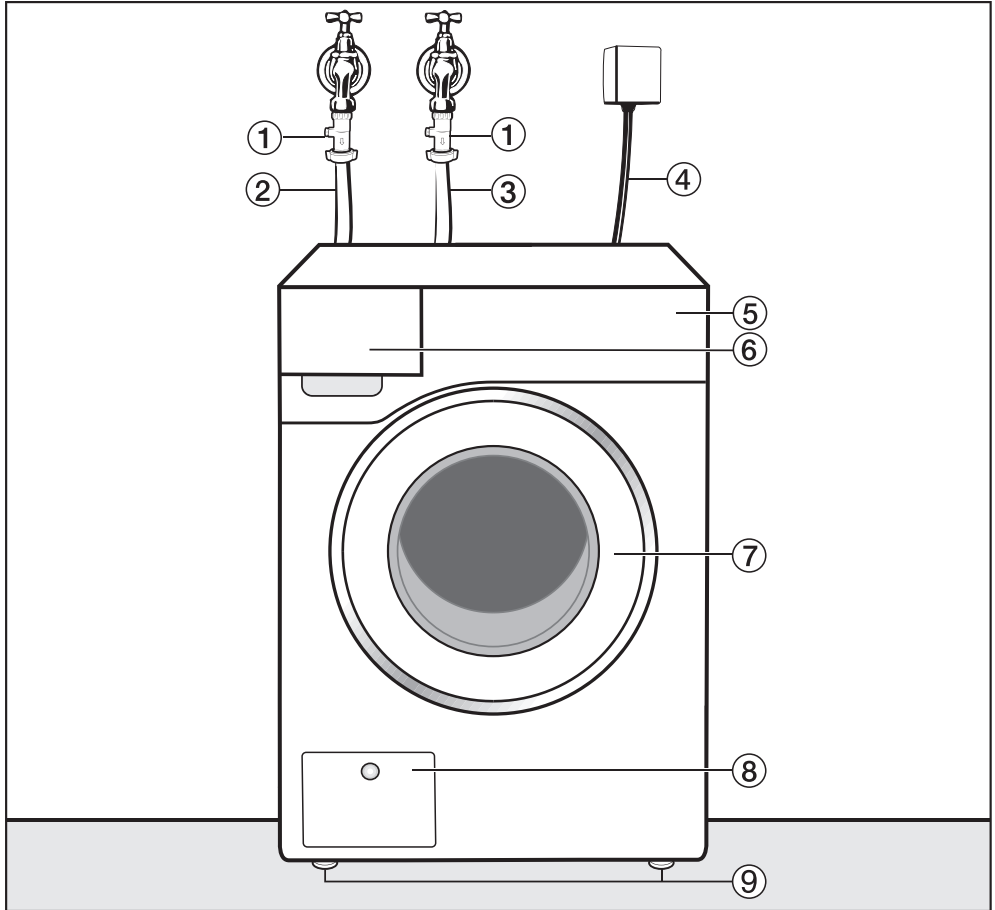

- ① Double check valves (for UK only)
- ② Inlet hose (cold water)
- ③ Inlet hose (hot water)
- ④ Electrical connection
- ⑤ Fascia panel
- ⑥ Detergent drawer
- ⑦ Door
- ⑧ Access to drain filter and drain pump and emergency release
- ⑨ Height-adjustable feet

Rear view

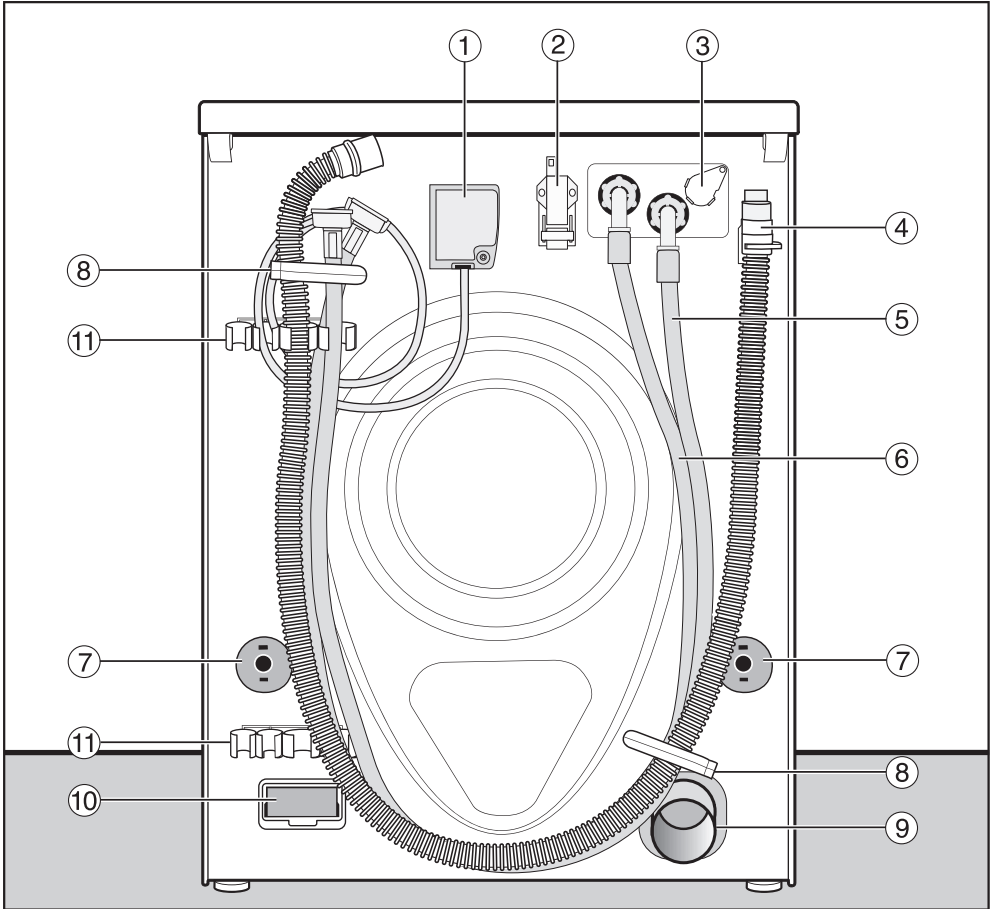

- | | |
|---|---|
| ① Electrical connection | ⑦ Safety caps for transit bars |
| ② Interface for communicating with external devices | ⑧ Transport clips for hoses |
| ③ Socket for external dispensing system | ⑨ Drain pipe (AV version) |
| ④ Drain hose (LP version) | ⑩ Module slot (for external communication module) |
| ⑤ Inlet hose (cold water) | ⑪ Holder for removed transit bars |
| ⑥ Inlet hose (hot water), if fitted | |

Installation

Installation locations

Side view

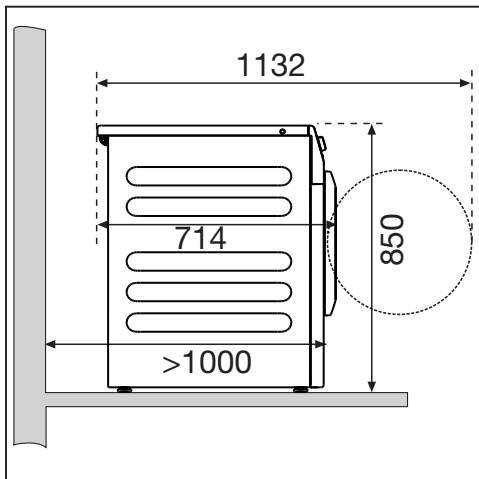

⚠ Installing the washer-dryer stack on a Miele plinth is not permitted.

Installation on a plinth

The washing machine can be installed on a steel plinth (open or closed, available as an optional Miele accessory) or on a concrete plinth.

⚠ Injury can occur if the washing machine has not been adequately secured.

When installing the machine on a plinth, there is the danger of the washing machine falling off the plinth during spinning.

Secure the washing machine using the clamps supplied.

Washer-dryer stack

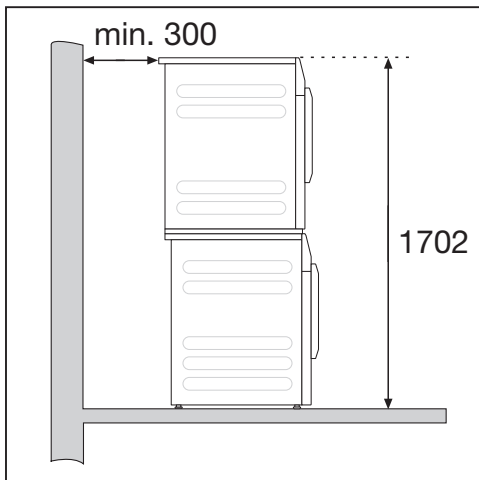

Installation notes

The distances between the machine and the wall are recommendations to help make it easier to carry out service work. If installation space is limited, the machine can also be pushed up against the wall.

This washing machine is not suitable for building under.

⚠ Risk of damage due to moisture ingress.

Moisture can damage electrical components.

Do not install the machine near or directly above an open gully or floor drain.

The washing machine can be installed as a washer-dryer stack together with a Miele tumble dryer. This requires a Miele washer-dryer stacking kit which can be purchased separately.

Transporting the washing machine to its installation site

⚠ Danger of injury from incorrect transport.

If the washing machine tips up there is a danger of injury to people and damage to property.

Make sure the washing machine is stable during transportation.

Transporting the washing machine with a sack truck

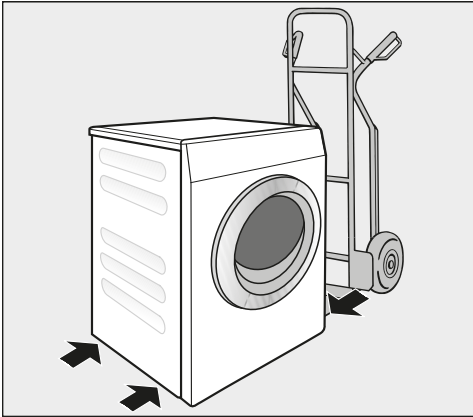

- If transporting the washing machine with a sack truck, make sure its left or right side is resting on the truck.

⚠ Risk of damage from incorrect transport.

The front or back of the washing machine may be damaged if the machine is transported with a sack truck.

Always insert the sack truck under one of the sides of the washing machine.

Transporting the washing machine to its installation site

The protruding lid at the back can be used to hold the machine when transporting.

⚠ Danger of injury due to unsecure lid.

The fixings at the back of the lid could break as a result of external forces. There is a danger of the lid being pulled off when carrying the machine.

Before carrying the machine, check that the lid is secure where it protrudes at the back of the machine.

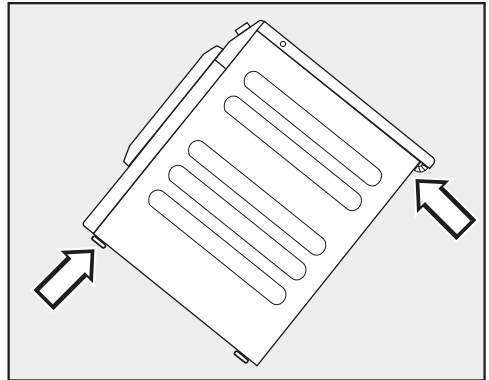

- Carry the washing machine by the front feet and by the lid where it protrudes at the back of the appliance.

Installation

Installation surface

A concrete floor is the most suitable installation surface, being far less prone to vibration during the spin cycle than wooden floorboards or a carpeted surface.

- The machine must be level and securely positioned.
- To avoid vibrations during spinning, the machine should not be installed on soft floor coverings.

If installing on a wooden joist floor:

- Install the machine on a plywood base (at least 70 x 60 x 3 cm). The base should span several joists and be bolted to the joists and not only to the floorboards.

Tip: If possible, install the machine in a corner of the room. This is usually the most stable part of the floor.

Removal of transit bars

Removing the left-hand transit bar

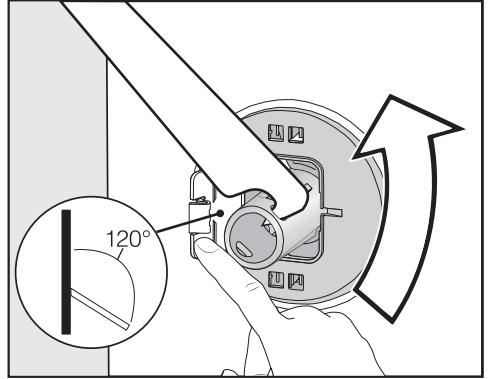

- Push the cover out and turn the transit bar 90° using the open spanner supplied.

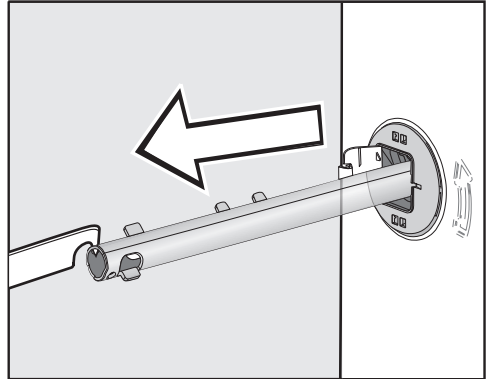

- Pull out the transit bar.

Removing the right-hand transit bar

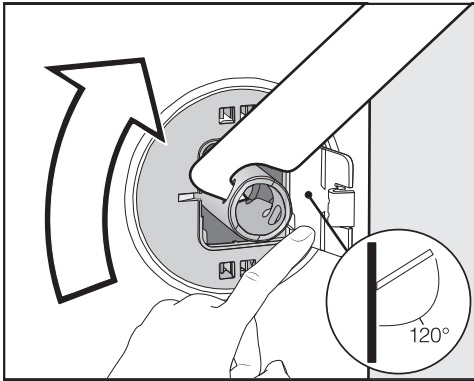

- Push the cover out and turn the transit bar 90° using the open spanner supplied.

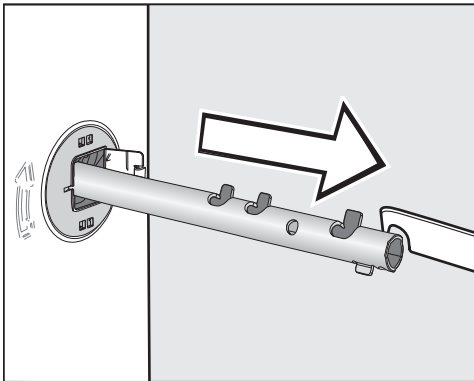

- Pull out the transit bar.

Covering holes

⚠ Danger of injury from sharp edges.

There is a danger of injury from reaching into holes that are not covered.

Cover the holes for the transit bars after they have been removed.

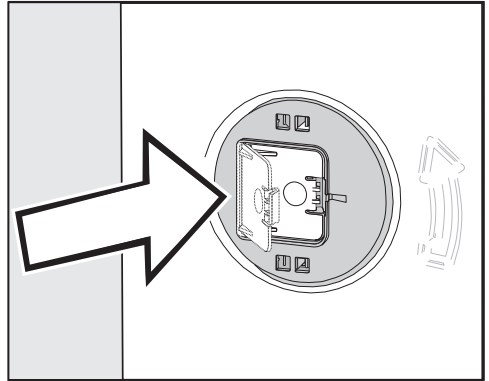

- Push the covers in firmly until they engage in position.

Securing the transit bars

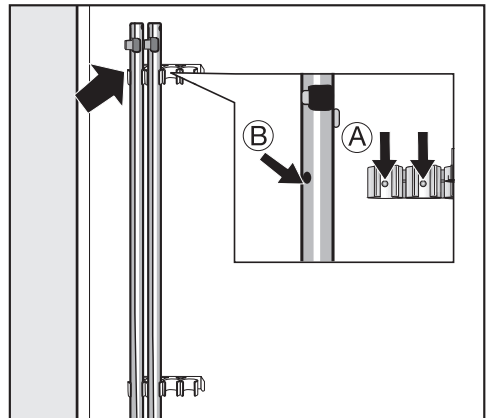

- Secure the transit bars to the back of the washing machine.

Tip: Make sure that the holes **Ⓑ** are fitted over the retainers **Ⓐ**.

Installation

 Risk of damage from incorrect transport.
The washing machine may become damaged if moved without the transit bars in place.
Keep the transit bars in a safe place.
Fit them again if the washing machine is to be moved (e.g. when moving house).

Fitting the transit bars

Opening the covers

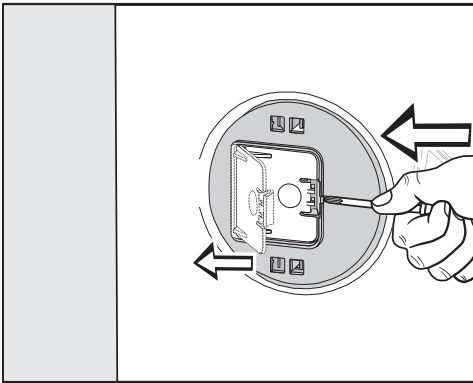

- Press against the retainer with a sharp object (a narrow screwdriver, for example).

The cover opens.

Fitting the transit bars

- To fit the bars, follow the instructions for removing them in reverse order.

Tip: The bars will slide in more easily if you lift the drum slightly.

Levelling the washing machine

The washing machine must stand perfectly level on all four feet to ensure safe and proper operation.

Incorrect installation may increase electric and water consumption and may cause the machine to move about.

Screwing out and adjusting the feet

The 4 adjustable screw feet are used for levelling the washing machine. The machine is supplied with all four feet screwed in.

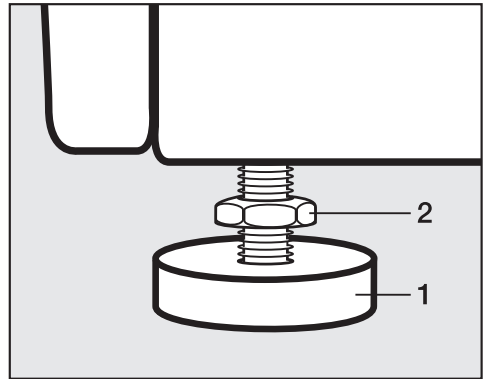

- Using the spanner supplied, turn counter nut **2** in a clockwise direction. Then turn counter nut **2** together with foot **1** to unscrew.

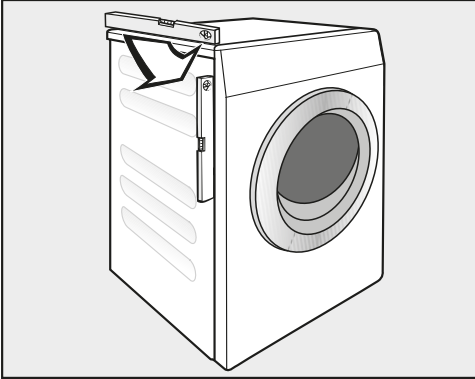

Holding bracket for plinth

The holding bracket prevents the washing machine from falling off the plinth during operation.

Fastening with the holding bracket is only intended for plinths made from concrete. The plinth must be flat and level. The surface below the plinth must be able to withstand the physical loads. Prior to installation, check whether the plinth complies with the minimum dimensions.

Height 6 cm

:

Width: 60 cm

Depth: 65 cm

Positioning the holding bracket

 Risk of injury from sharp edges.

The holding bracket has sharp edges. You could cut yourself on the edges. Take care when handling the holding bracket.

Wear gloves while installing the holding bracket.

The front appliance feet must protrude by at least 3 mm. The washing machine must already be aligned (see “Installation – Aligning the washing machine”)

- Use a level to check that the washing machine is standing level.
- Hold foot **1** securely with a pipe wrench. Turn counter nut **2** again using the spanner supplied until it sits firmly up against the housing.

 Risk of damage due to incorrectly aligned washing machine.

There is a danger of the washing machine moving about if the feet are not secured.

Turn all 4 counter nuts for the feet until they sit firmly up against the housing. Please also check this for the feet which did not need adjustment.

Installation

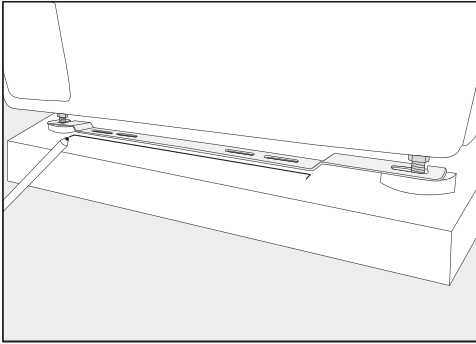

- Place the holding bracket on the front appliance feet.
- Mark the position of the front edge of the holding bracket with a pencil.
- Remove the holding bracket from the feet.
- Carefully move the washing machine until you have enough space to install the holding bracket.

Installing the holding bracket

- Place the holding bracket on the marking on the plinth.
- In the middle of the two outer slotted holes, mark a point for each drill hole.
- Drill 2 holes (8 mm) with a depth of approx. 55 mm.
- Insert the plugs in the holes.

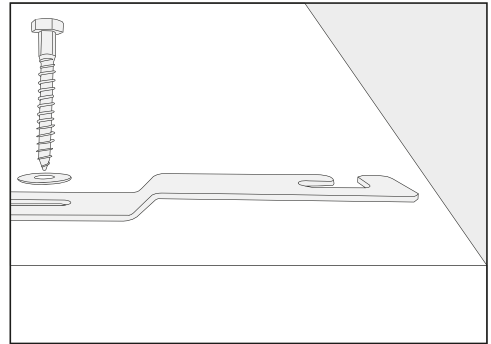

- Install the holding bracket with the hexagon screws and the washers.

Do not tighten the screws yet – this will allow the holding bracket to be moved sideways.

Securing the washing machine with the holding bracket

- Push the washing machine back on to the installed holding bracket.

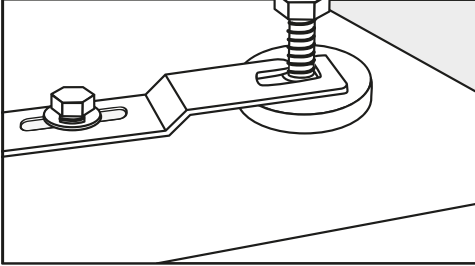

- Insert the appliance feet (the part between the foot and the locknut) into the openings in the holding bracket.
- Push the holding bracket to the right as far as it will go.
- Tighten the hexagon screws using a spanner.

The washing machine is secured in the holding bracket.

External control equipment

The XCI box accessory is needed to connect external control equipment, such as payment systems, dispensing systems or peak load control units.

Payment system

This washing machine can be fitted with a payment system (optional accessory).

The necessary reprogramming must always be carried out by Miele Service or a Miele Service Dealer.

Coins/tokens must be removed from the coin box regularly. Otherwise, the payment system will become blocked.

Installation

Water connection

Cold water connection

The washing machine should be connected to a mains water supply in accordance with current local and national safety regulations. The German authorities do not require it to have a non-return valve as the washing machine has been designed to comply with DIN regulations.

In the U.K. both the hot and cold water supplies must be connected to the mains water connection with the provided double check valve. Hot water temperature must not exceed 60 °C.

The flow pressure must amount to a minimum of 100 kPa and must not exceed 1000 kPa. If the pressure exceeds 1000 kPa, a pressure reducing valve must be installed.

For the connection, a stopcock with a $\frac{3}{4}$ " screw thread is required. If this type of stopcock is not available, only a qualified installer may connect the washing machine to the mains water supply.

The connection point is subject to mains water pressure. Turn on the stopcock slowly and check for leaks. Correct the position of the washer and screw thread if appropriate.

Switching to cold water operation

If the washing machine is not connected to a hot water point, you will have to configure the settings *Main wash water*, *Pre-wash water* and *Rinse water* to cold (see "Supervisor level").

- Unscrew the hot water hose.
- Screw on the stopper provided.

Maintenance

Only use genuine Miele hoses that have been tested to withstand pressure of at least 7000 kPa should you ever need a replacement.

A filter is located in the intake point to protect the water inlet valve. Neither filter may be removed.

Hose extension

Longer hoses are available from Miele or from your Miele dealer as accessories.

Hot water connection*

The hot water temperature must not exceed 70 °C (60 °C in the UK).

To minimise energy consumption during operation with hot water, the washing machine should be connected to a suitable hot water ring circuit. So-called “transmission pipes” (single pipes to hot water generators) can result in any water remaining in the pipes cooling down if not in constant use. More energy would then be consumed to heat the liquid up again.

The same connection requirements as for cold water also apply to hot water.

The inlet hose is connected to the stopcock.

The washing machine cannot only be connected to a hot water connection.

* Some machine versions do not come with a hot water hose.

Switching to hot water operation

If the washing machine is due to be connected to a hot water point, you can configure the settings *Main wash water*, *Pre-wash water* and *Rinse water* to hot (see “Supervisor level”).

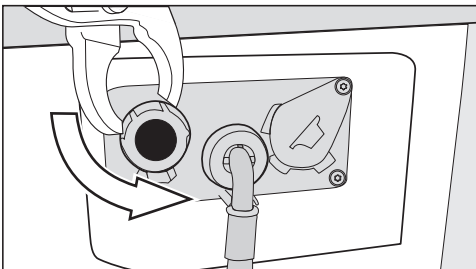

- Unscrew the stopper from the hot water valve.
- Screw on the hot water hose.

Drainage

Drain valve

The machine is drained using a motorised drain valve. A DN 70 angle connector can be used for draining the machine via an on-site floor drain (gully with odour trap).

Drain pump

The suds are drained through a drain pump with a 1 m delivery head. For the water to drain freely, the hose must be free of kinks. The elbow piece (accessory) can be hooked onto the end of the hose.

Drainage options

1. Connected securely to a plastic drain pipe with a rubber nipple (there is no need to use a siphon).
2. Connected securely to a washbasin with a plastic nipple.
3. Connected securely to a floor drain (gully).

If required, the hose can be extended to a length of up to 5 m. Accessories are available from Miele or from your Miele dealer.

For a drain height of more than 1 m (up to a max. of 1.6 m), a replacement drain pump is available from Miele or from your Miele dealer.

Installation

Electrical connection

This description applies to washing machines both with and without a mains plug.

The following applies to washing machines with a mains plug:

- The washing machine is ready to be connected.
- The electrical socket must be easily accessible after installation so that the machine can be disconnected from the electricity supply if necessary. It is always recommended to connect the washing machine to the electrical supply with a suitably rated plug and protected socket as per local and national regulations.

 **Damage caused by incorrect supply voltage.**

The data plate indicates the nominal power consumption and the appropriate fuse rating.

Compare the specifications on the data plate with those of the mains electricity supply and make sure that they match.

The washing machine may only be connected to a permanent electrical system that conforms to the national and local codes and regulations.

Do not connect the machine to an extension lead or multi-socket adapter as they do not guarantee the required safety of the appliance (e.g. danger of overheating).

If the machine is hard wired, an all pole circuit breaker must be provided on-site. When switched off there must be an all-pole contact gap of at least 3 mm in the isolator switch (including miniature circuit breaker, switch, fuses and relays ac-

ording to IEC/EN 60947). This connection process must be performed by a qualified electrician.

The plug connector or isolator switch should be easily accessible at all times.

 **Risk of electric shock.**

If the washing machine is disconnected from the mains, protective measures must be taken to ensure that the point of disconnection cannot accidentally be switched on again.

Make sure the isolator is lockable or the point of disconnection is monitored at all times.

New connections, modifications to the system, or servicing of the earthing conductor, including determining the correct fuse amperage, must be carried out by a qualified electrician, as they are familiar with the pertinent regulations and the specific requirements of the electric utility company.

If converting the washing machine to an alternative voltage, observe the instructions in the wiring diagram. Conversion must be performed by Miele Service or by an authorised Miele dealer.

Single phase AC 230 V – country variant 230V 25A

This device is intended for connection to a power supply system where the maximum value of external phase neutral loop impedance Z_{max} of 0.38 Ohms at the point of distributor supply connection is not exceeded.

The user has to ensure that this device is connected only to a power supply system which fulfils the requirement above. If in doubt, please ask your electrical distributor for actual impedance value.

Technical data

Height	850 mm
Width	596 mm
Width (for appliances with a stainless steel lid)	605 mm
Depth	714 mm
Depth with door open	1132 mm
Weight	Approx. 100 kg
Maximum floor load in operation	3000 newtons
Capacity	7.0 kg dry laundry
Supply voltage	See data plate on back of appliance
Rated load	See data plate on back of appliance
Fuse rating	See data plate on back of appliance
A-rated sound emissions L_{pA} in accordance with EN ISO 11204/11203	< 70 dB re 20 μ Pa
Minimum water flow pressure	100 kPa (1 bar)
Maximum water flow pressure	1000 kPa (10 bar)
Water inlet hose length	1.55 m
Connection cable length	1.80 m
Maximum delivery head (drain pump)	1.00 m
LEDs	Class 1
Product safety standard	EN 50571, EN 60335
Test certifications awarded	See data plate
Power rating in off mode	0.40 W
Networked standby	0.80 W
Frequency band of the WiFi module	2.4000 GHz – 2.4835 GHz
Maximum transmission power of the WiFi module	< 100 mW

Technical data

EU Conformity declaration

Miele hereby declares that this washing machine complies with Directive 2014/53/EU.

The complete text of the EU declaration of conformity is available from one of the following internet addresses:

- Products, Download from www.miele.ie
- For service, information, operating instructions etc: go to <https://miele.co.uk/> manuals and enter the name of the product or the serial number

UK Conformity declaration

Miele hereby declares that this washing machine complies with UK Radio Equipment Regulations 2017, as amended.

The complete text of the UK declaration of conformity is available from one of the following internet addresses:

- Products, Download from www.miele.co.uk
- For service, information, operating instructions etc: go to <https://miele.co.uk/> manuals and enter the name of the product or the serial number

This **Statement of Compliance** confirms this Miele product fully complies with the **Product Security and Telecommunications Infrastructure (Security Requirements for Relevant Connectable Products) Regulations 2023**.

- 1) Household Appliance – *Professional Washing Machine GW06, GW08*
- 2) Manufactured by: Miele & Cie KG,
Carl Miele Street 29, 33332 Gutersloh Germany
Imported by and contact point: Miele Company Ltd, Fairacres, Marcham Road,
Abingdon, Oxon, OX14 ITW Great Britain
- 3) The defined support period at the time of first supply is 10 years
- 4) To report vulnerabilities and cybersecurity issues please contact: psirt@miele.com
- 5) Signature 

Name: **Paul Wright**

Company Position: **Head of Technical Management**

Date of signature: **19th March 2024**

Place of signature: **Abingdon, Oxfordshire**

Programme	Load kg	Energy kWh	Water Litres	Programme running time h:min	Temperature ¹ °C	Residual mois- ture %	Speed rpm
ECO 40-60*	7.0	0.60	45	3:19	34	44	1600
	3.5	0.45	38	2:39	31	44	1600
	2.0	0.23	26	2:39	24	44	1600
Cottons	7.0	0.98	49	0:59	48	48	1600
	20 ²	0.20	49	0:59	20	48	1600
Minimum iron	3.5	0.30	50	0:45	28	38	1200
Express	3.5	0.30	30	0:20	30	60	1400

* Test programme for compliance with EU legislation regarding ecodesign 2019/2023 and energy labelling in accordance with Regulation No. 2019/2014

¹ Maximum laundry temperature reached in main wash.

² 20 °C programme for lightly soiled cotton garments.

Consumption data can vary from the nominal values given depending on water pressure, water hardness, water inlet temperature, room temperature, type and volume of load, fluctuations in the mains voltage and any extra options selected.

Consumption data

13 A variant (See data plate on back of machine)

Programme	Load kg	Energy kWh	Water Litres	Programme running time h:min	Temperature ¹ °C	Residual mois- ture %	Speed rpm
ECO 40-60*	7.0	0.60	45	3:19	34	44	1600
	3.5	0.45	38	2:39	31	44	1600
	2.0	0.23	26	2:39	24	44	1600
Cottons	7.0	0.98	49	1:09	48	48	1600
	2.0	0.20	49	1:09	20	48	1600
Minimum iron	3.5	0.30	50	0:45	28	38	1200
Express	3.5	0.30	30	0:20	30	60	1400

* Test programme for compliance with EU legislation regarding ecodesign 2019/2023 and energy labelling in accordance with Regulation No. 2019/2014

¹ Maximum laundry temperature reached in main wash.

² 20 °C programme for lightly soiled cotton garments.

Consumption data can vary from the nominal values given depending on water pressure, water hardness, water inlet temperature, room temperature, type and volume of load, fluctuations in the mains voltage and any extra options selected.

Supervisor level

The settings menu in the  Supervisor level is locked against unauthorised access. The menu can be unlocked with a code.

Code-based access

Supervisor level is accessed using a code.

The code is **000** (factory default).

Changing the code

You can alter the Supervisor level access code to protect the washing machine from unauthorised access.

Please inform Miele Service if you have forgotten your new code. Miele Service will have to reset the code. Make a note of your new code and store it in a safe place.

Opening the Supervisor level

- Touch the  sensor.

The  symbol appears in the display if e.g. you turn the programme selector to the *Drain/Spin* programme.

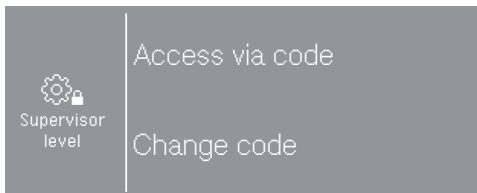

- Select Access via code.

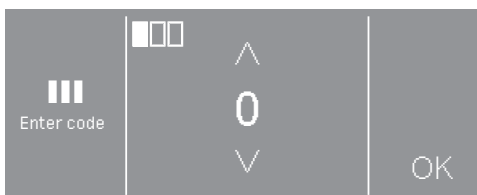

- Enter the individual numbers and confirm each selection with OK.

The Supervisor level settings are opened.

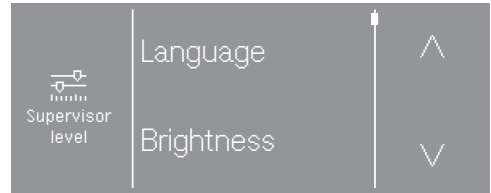

- Select the setting you want.

Some settings are only visible if external devices are connected via the XCI box.

Exiting the Supervisor level

- Touch the  sensor or switch off the washing machine.

Language

The display can be set to appear in one of several different languages. To select the permanent operator language you want, go to the Languages sub-menu.

When a programme is running, you can change the user language using the  sensor.

Brightness

The brightness of the display can be set in intervals of ten % from 10 % to 100 %.

Factory default: 70 %

Supervisor level

Clock display

After selecting the clock format, you can set the time of day.

Clock format

- 24 h clock (factory default)
- 12 h clock
- Clock off

Set

- The time of day can be set.

Finish tone volume

The volume can be changed for the buzzer that sounds at the end of the programme.

It can be set to one of 7 different levels or switched off altogether.

Factory default: Off

Keypad tone volume

The volume of the tone that sounds when a sensor is touched can also be changed.

It can be set to one of 7 different levels or switched off altogether.

Factory default setting: normal

Welcome tone volume

The volume of the welcome tone that sounds when the washing machine is switched on can be changed.

It can be set to one of 7 different levels or switched off altogether.

Factory default setting: normal

Fault alarm

The tone that sounds in the event of a fault can be switched on or off.

Factory default: Off

Memory

The washing machine will save the settings (temperature, spin speed and some of the options) which have been selected for a programme after the programme has started.

When the programme is chosen again, the saved settings will appear in the display.

Factory default: Off

Anti-crease

The Anti-crease function reduces creasing after the end of the programme.

At the end of the programme, the drum continues to turn at intervals for up to 30 minutes. The washing machine door can be opened at any time.

Factory default: On

Suds cooling

Additional water flows into the drum at the end of the main wash to cool the suds down.

Suds cooling takes place when a programme with a temperature of 70 °C or higher is selected.

Suds cooling should be activated:

- To prevent the danger of scalding if the drain hose is hooked over the edge of a sink or basin.
- Where the drainage pipes do not comply with DIN 1986.

Factory default: On

"Display" switch-off status

To save energy, the display goes out and the *Start/Stop* button flashes slowly.

Changing this setting leads to increased energy consumption.

- Off
The display will remain on.
- On after 10 min, not in current programme (factory default)
The display will remain on while the programme is running but will go out 10 minutes after the end of the programme.
- On after 30 min, not in current programme
The display will remain on while the programme is running but will go out 30 minutes after the end of the programme.
- On after 10 min
The display will go out after 10 minutes.
- On after 30 min
The display will go out after 30 minutes.

Delay start

The type of time input for the Delay start function can be changed or switched off.

- Off
The Delay start function is not available for selection.
- End of programme (factory default)
With the Delay start function, you specify at what time the wash programme should end.
- Beginning of programme
With the Delay start function, you specify at what time the wash programme should begin.
- Time until start
With the Delay start function, you specify after how many hours a programme should begin.

SmartStart

The function of the  sensor control changes when the *SmartGrid* setting is activated and the *Time until start* option is selected in the *Delay start* setting. The period of time in which the wash programme will start automatically is then shown in the display: *SmartStart*

The programme is started via an external signal.

The time period can be defined up to 24 hours. During this period, the washing machine waits for the external signal. If no signal is sent during the defined period, the washing machine starts the drying programme once the defined period of time has elapsed.

Supervisor level

Programme name

When selecting a standard programme, the name of the selected programme is shown in the display.

- On (factory default)
When a programme is selected, the programme name is displayed for a few seconds before the display shows the main menu.
- Off
The main menu is displayed immediately.

Visibility parameters

Various parameters are offered/displayed when a programme is selected. You can decide which parameters should not be displayed. These parameters can then not be edited during programme selection.

Factory default: all parameters are visible.

Pre-wash water

You can select the water type for the pre-wash.

- Cold
Only cold water is used for the pre-wash.
- Hot
Hot water is also added for the pre-wash.
Hot water can only be added if the wash temperature is above 30 °C.

Main wash water

You can select the water type for the main wash.

- Cold
Only cold water is used for the main wash.
- Hot
Hot water is also added for the main wash.
Hot water can only be added if the wash temperature is above 30 °C.

Programme durations will be longer if the machine is not connected for hot water; this may mean that the “Time left” display is incorrect.

First rinse water

You can select the water type for the first rinse in some programmes.

- Cold (factory default)
Only cold water is used for the first rinse.
- Hot
Hot water is also added for the first rinse.

Final rinse water

You can select the water type for the last rinse in some programmes.

- Cold (factory default)
Only cold water is used for the final rinse.
- Hot
Hot water is also added for the final rinse (only possible for programmes with a temperature of at least 60 °C).

Low water pressure

If the water pressure is below 100 kPa (1 bar), the programme will be cancelled and the fault message *Check water inlet* will appear.

If the on-site water pressure cannot be increased, activating the setting *Low water pressure* will prevent the programme from being cancelled.

Factory default: On

Empty sensor

A siphon contact can be used to detect whether external detergent containers are empty. A message appears if a container is empty.

- Off (factory default)
The Empty sensing function is switched off.
- Normally open contact
The siphons are equipped with a normally open contact.
- Normally closed contact
The siphons are equipped with a normally closed contact.

Early warning counter

An internal counter reports when an external dispenser container is almost empty. The counter in question then has to be reset.

Water level Cottons

You can increase the water level for the main wash in the *Cottons* programme.

- + 0 mm wc (factory default)
- + 10 mm wc
- + 20 mm wc
- + 30 mm wc

Water level Minimum iron

You can increase the water level for the main wash in the *Minimum iron* programme.

- + 0 mm wc (factory default)
- + 10 mm wc
- + 20 mm wc
- + 30 mm wc

Cottons Pre-wash temp

You can select the temperature for the pre-wash in the *Cottons* programme.

- 30 °C (factory default)
- 35 °C
- 40 °C
- 45 °C

Wash time Pre-wash

You can increase the duration for the pre-wash in the *Cottons* programme.

- + 0 min (factory default)
- + 6 min
- + 9 min
- + 12 min

Supervisor level

Wash time Cottons

You can increase the duration for the main wash in the *Cottons* programme.

- + 0 min (factory default)
- + 10 min
- + 20 min
- + 30 min
- + 40 min

Wash time Minimum iron

You can increase the duration for the main wash in the *Minimum iron* programme.

- + 0 min (factory default)
- + 5 min
- + 10 min
- + 15 min
- + 20 min

Pre-rinse Cottons

A pre-rinse can be activated in the *Cottons* programme.

Factory default: Off

Pre-rinse Minimum iron

A pre-rinse can be activated in the *Minimum iron* programme.

Factory default: Off

Pre-wash Cottons/Min. iron

In the programmes *Cottons* and *Minimum iron*, you can choose whether a pre-wash is permanently activated or whether it can be selected during programme selection.

Factory default: Menu selection

Cottons rinses

You can alter the number of rinse cycles in the *Cottons* programme.

- 1 rinse cycles
- 2 rinse cycles (factory default)
- 3 rinse cycles
- 4 rinse cycles
- 5 rinse cycles

Min. iron rinses

You can alter the number of rinses carried out in the *Minimum iron* programme.

- 2 rinses (factory default)
- 3 rinses
- 4 rinses

Disinfection rinse

Additional rinses can be activated in disinfection programmes with a temperature of at least 60 °C.

Rinsing is carried out with hot water. The programme duration is longer.

The laundry may feel hot at the end of the programme.
Take care when removing items.

Factory default: Off

Programme packages

The selection of programmes can be expanded by activating single programmes from the target group programme packages.

The programmes selected from the programme packages are displayed under *Special programmes* ☆.

- Sport
- Outerwear
- Wellness/Hair salons
- Hotels
- Home textiles
- Workwear
- Disinfection

After selecting the programme packages, the individual programmes from the list are activated. Activated programmes are marked with a frame. The selection must then be confirmed.

Disinfection prog. code

A code has to be entered to cancel a disinfection programme. The code can be modified.

The code is: 0 0 0

Tip: Make a note of your new code if you ever change it.

Temp reduction

The suds temperature can be reduced to prevent the suds from boiling too early in high-altitude locations.

Factory default: Off

Auto load control

This washing machine comes with automatic load control. In some programmes, the water levels and the programme cycle times are adapted to the load. If the auto load control is deactivated, the machine will always carry out the programme sequence based on a full load.

Factory default: On

CapDosing

You can choose whether CapDosing is displayed in the *Further choices* list.

Factory default: Off

Pre-ironing

You can choose whether Pre-ironing is displayed in the *Extras* list.

Factory default: On

Supervisor level

Hygiene

The Maintenance wash hygiene programme is shown in the list of *Special programmes*.

If a programme at a temperature below 60 °C has been used, a request to start the Maintenance wash hygiene programme appears in the display.

Factory default: Off

Automatic dispensing

Automatic dispensing via an external dispensing system can be activated

Factory default: Off

Adjustment value dosage 1–6

To respond to the tolerances that occur in the pump system over time, the dosage amount (ml/min) for the pumps can be corrected.

The calibration value can be reduced by 3 increments or increased by 3 increments.

The calibration value is increased or reduced by 1, 2 or 3 times the adjustment value based on the selected incremental setting.

The calibration value and the adjustment value must be added to the data for the dispenser pumps by the Miele Customer Service Department.

COM module selection

This washing machine is equipped with an integrated WiFi module. However, the washing machine can also be equipped with an external module.

- Off (factory default setting)
- Internal module
The internal WiFi module is used.
- External module
An XKM module or RS232 module is inserted into the module slot.

Availability of Miele digital products

The ability of Miele digital products depends on the availability of the services in your country.

The different services are not available in all countries.

For information about availability, please visit www.miele.com.

WiFi/LAN

Control the networking of your washing machine.

- Setup
This message only appears if the washing machine has not yet been connected to a WiFi network.
- Deactivate (visible if the network is activated).
The network remains set up; the WiFi function is switched off.
- Activate (visible if the network is deactivated).
The WiFi function is reactivated.
- Connection status (visible if the network is activated)
 - The quality of WiFi reception
 - The network name
 - The IP address
- Set up again (visible if already set up).
Resets the WiFi login (network) to immediately re-establish a new connection.
- Reset (visible if already set up)
The network is no longer set up. A new connection has to be established in order to use the network again.

Supervisor level

- The WiFi is switched off.
- The WiFi connection will be reset to the factory default setting.

WiFi setup

There are 2 possible connection methods.

WPS

- Activate the WPS function on your router within 2 minutes.

Tip: If the connection has not been set up when the timeout has finished counting down, repeat the process.

Soft AP

- Activate the function with the Miele app on your smart device within 10 minutes.

Tip: The app will guide you through the remaining steps.

Network time

The date and time can be synchronised over the network.

- Off

The date and time are not synchronised over the network.

- As master

The machines are in a network but are not connected to the Internet. A machine is declared as the master and sends data to the *slave* devices.

- As slave

The machines are in a network and are connected to the Internet. All machines are configured as *slaves*. Data is synchronised over the Internet.

Peak load signal

The peak-load negotiation function enables the washing machine to be connected to an energy management system. When a signal is registered, the washing machine's heater is switched off for a short period. The washing machine may only be operated with a peak-load system if this system is connected to the washing machine via the Miele XCI box.

- No function (factory default)
- Peak load with 230 V
- Peak load with 0 V

Peak load prevention

The peak-load negotiation function can be deactivated with disinfection programmes. When a signal is registered, the washing machine's heater is not switched off.

Factory default: Off

Remote

Operating data relating to the washing machine (e.g. fault messages or notifications) is communicated externally.

Factory default: On

RemoteUpdate

The RemoteUpdate function is used to update the software in your washing machine.

RemoteUpdate is activated by default.

If you do not install a RemoteUpdate, you can continue to use your washing machine in the usual way. However, Miele recommends installing RemoteUpdates.

Running a RemoteUpdate

If a RemoteUpdate is available for your washing machine, it will be displayed automatically when the operator level is open.

You can choose to start the RemoteUpdate immediately or wait until later. If you select "Start later", the prompt to run the RemoteUpdate will be displayed again the next time you switch on your washing machine.

The RemoteUpdate can take a few minutes.

Please note the following information about the RemoteUpdate function:

- You will only receive a message when a RemoteUpdate is available.
- Once a RemoteUpdate has been installed, it cannot be undone.
- Do not switch off the washing machine during a RemoteUpdate. Otherwise, the RemoteUpdate will be aborted and will not be installed.

Supervisor level

SmartGrid

You can use the SmartGrid setting to integrate your washing machine into building energy management systems.

Factory default: Off

Clean the drain pump

The user sees a message when the drain pump filter has to be cleaned.

The message is displayed every 500 operating hours.

The message appears at the end of the programme.

Factory default: Off

Legal information

Open source licences

You can view information here.

Copyrights and licences for operator and control software

Miele uses their own and third party software which is not subject to any so-called open source licence for the operation and control of the machine. This software/these software components are protected by copyright. The copyright powers of Miele and third parties have to be respected.

Furthermore, this machine contains software components which are distributed under open source licence conditions. Please refer to the menu item Settings | Machine parameters | Legal information | Open source licences in the machine for the Open Source components contained therein, together with the corresponding copyright notices, copies of the licencing conditions valid at the time, and any further information. The liability and warranty provisions of the Open Source licence terms and conditions as stated therein apply only in relation to the respective rights holders.

Payment system

If you wish to change the settings after the commissioning process, please contact the Miele Customer Service Department.

The XCI-AD or XCI box accessory unit is required to connect a payment system.

Settings for payment systems

You would like to connect a payment system.

- No payment system
The next settings are skipped and initial commissioning can be completed.
- Programme operation
The machine is operated using a coin box. The user purchases a wash programme.
- Timed operation
The machine is operated using a coin box. The user purchases a time-managed programme.
- COM module
The machine is operated by a central control unit.

Feedback signal to pay system

Setting the feedback signal for the coin box.

- Factory default: Off
- End of programme
The feedback signal is sent at the end of the programme.
- Release of the start button
The feedback signal is sent when the start button is released.
- Start and programme end
The feedback signal is sent at the start and end of the programme.
- Programme running
The feedback signal is sent constantly between the start and end of the programme.

Payment system lock

To avoid tampering, a programme lock can be set up in programme control. If the lock is applied, the programme is interrupted and payment credit is lost as soon as the door is opened.

- The time for the lock to be applied can be adjusted to enable laundry to be added.
- Off
 - As soon as the programme starts
 - 1 minute after the start of the programme
 - 2 minutes after the start of the programme
 - 3 minutes after the start of the programme (factory default)
 - 4 minutes after the start of the programme

Supervisor level

- 5 minutes after the start of the programme

FOC programmes

In coin mode, you can decide whether the Drain/Spin programme can be used for free.

Factory default: Off

Delete paid signal

The “Paid” signal in coin box mode can be applied until the end of the programme or discarded if the programme is not started after 5 minutes.

Factory default: Off

Debounce time

In coin mode, the debounce time for the minimum payment signal that must be applied can be adjusted.

- Factory setting: Short
For coin boxes where the falling coin generates the paid pulse.
- Long
For central control units on a 230 V basis.

United Kingdom

Miele Co. Ltd., Fairacres, Marcham Road
Abingdon, Oxon, OX14 1TW
Professional Sales, Tel: 0845 365 6608
E-mail: professional@miele.co.uk
Internet: www.miele.co.uk/professional

Australia

Miele Australia Pty. Ltd.
ACN 005 635 398, ABN 96 005 635 398
Level 4, 141 Camberwell Road, Hawthorn East, VIC 3123
Tel: 1300 731 411
Internet: www.miele.com.au/professional
E-mail: professional.sales@miele.com.au

China Mainland

Miele Electrical Appliances Co., Ltd.
1-3 Floor, No. 82 Shi Men Yi Road
Jing' an District, 200040 Shanghai, PRC
Tel: +86 21 6157 3500, Fax: +86 21 6157 3511
E-mail: info@miele.cn, Internet: www.miele.cn

Hong Kong, China

Miele (Hong Kong) Ltd.
41/F - 4101, Manhattan Place
23 Wang Tai Road, Kowloon Bay, Hong Kong
Tel: (852) 2610 1025, Fax: (852) 3579 1404
Email: customerservices@miele.com.hk
Website: www.miele.hk

India

Miele India Pvt. Ltd.
1st Floor, Copia Corporate Suites,
Commercial Plot 9, Mathura Road, Jasola,
New Delhi - 110025
E-mail: customercare@miele.in, Website: www.miele.in

Ireland

Miele Ireland Ltd.
2024 Bianconi Ave., Citywest Business Campus,
Dublin 24
Tel: (01) 461 07 10, Fax: (01) 461 07 97
E-Mail: info@miele.ie, Internet: www.miele.ie

Malaysia

Miele Sdn Bhd
Suite 12-2, Level 12
Menara Sapura Kencana Petroleum
Solaris Dutamas No. 1, Jalan Dutamas 1
50480 Kuala Lumpur, Malaysia
Phone: +603-6209-0288
Fax: +603-6205-3768

New Zealand

Miele New Zealand Limited
IRD 98 463 631
8 College Hill
Freemans Bay, Auckland 1011, NZ
Tel: 0800 464 353
Internet: www.miele.com.au/professional
E-mail: professional.sales@miele.com.au

Singapore

Miele Pte. Ltd.
29 Media Circle, #11-04 ALICE@Mediapolis
Singapore 138565
Tel: +65 6735 1191, Fax: +65 6735 1161
E-Mail: info@miele.com.sg
Internet: www.miele.sg

South Africa

Miele (Pty) Ltd
63 Peter Place, Bryanston 2194
P.O. Box 69434, Bryanston 2021
Tel: (011) 875 9000, Fax: (011) 875 9035
E-mail: info@miele.co.za
Internet: www.miele.co.za

United Arab Emirates

Miele Appliances Ltd.
Showroom 1, Eiffel 1 Building
Sheikh Zayed Road, Umm Al Sheif
P.O. Box 114782 - Dubai
Tel. +971 4 3044 999, Fax. +971 4 3418 852
800-MIELE (64353)
E-Mail: info@miele.ae
Website: www.miele.ae



Manufacturer: Miele & Cie. KG, Carl-Miele-Straße 29, 33332 Gütersloh, Germany

PWM 507

en-GB

M.-Nr. 12 715 010 / 00