

## Operating instructions Washer-disinfector for laboratory glassware and laboratory utensils PG 8583 CD



To avoid the risk of accidents or damage to the appliance, it is **essential** to read these instructions before it is installed and used for the first time.

en - GB, AE, AU, IE, NZ, ZA



<b>Notes about these instructions</b> .....	8
Definition of terms .....	8
<b>Appropriate use</b> .....	9
<b>User profiles</b> .....	10
User profiles .....	10
<b>Guide to the machine</b> .....	11
Overview.....	11
Control panel .....	12
LEDs in buttons .....	13
<b>Warning and Safety instructions</b> .....	14
Symbols on the machine.....	19
<b>Using the machine</b> .....	20
Display illustrations.....	20
Switching on.....	21
Switching off.....	21
Auto-off function .....	21
Ready for use .....	21
Display interface.....	22
Menu operation .....	22
Settings in the menu .....	23
Symbols on the display .....	24
<b>Commissioning</b> .....	25
Installation and connection .....	25
Procedure .....	25
<b>Opening and closing the door</b> .....	29
Electronic door locking.....	29
Opening the door .....	29
Closing the door.....	29
Opening the door using the emergency release .....	30
<b>Water softener</b> .....	31
Water hardness .....	31
Setting the water hardness level .....	32
Filling the salt reservoir.....	34
Add salt reminder .....	36
<b>Areas of application</b> .....	37
Mobile units, baskets, modules and inserts.....	37
Adjusting the upper basket .....	38
Preparing the load .....	40
<b>Chemical processes and technology</b> .....	44
<b>Adding and dispensing chemical agents</b> .....	48
Dispensing systems .....	48
Labelling of the siphons .....	48

# Contents

---

Neutralising agent .....	49
Replenishing neutralising agent .....	49
Refill indicator.....	50
Dispensing neutralising agent .....	50
Cleaning agent .....	51
Replenishing liquid cleaning agent.....	51
Refill indicator.....	52
Dispensing liquid detergent.....	52
<b>Operation</b> .....	53
Selecting a programme .....	53
Starting a programme .....	53
Starting a programme using delay start .....	53
Drying .....	55
Programme sequence indicator .....	57
At the end of the programme .....	57
Interrupting a programme.....	58
Cancelling a programme .....	59
Programme cancelled due to a fault .....	59
Cancelling a programme manually .....	59
System messages .....	60
Changing the filter .....	60
Cleaning the filter combination.....	60
Low fill levels .....	60
Spray pressure and spray arm monitoring .....	61
<b>Settings</b> ▾.....	62
Delay start .....	63
Drying .....	64
DOS venting .....	66
Language ▾ .....	67
Time of day.....	68
Volume.....	71
<b>Further settings</b> .....	72
Code.....	74
Enter code .....	74
Date .....	77
Log book .....	79
Report.....	80
Temperature unit.....	80
Programme settings .....	80
Air cooling .....	81
Release programme .....	82
Moving a programme: allocating programme selection buttons.....	83
Dispensing systems .....	84
DOS venting .....	85
Test programme .....	87
Filter maintenance .....	88
Cleaning the filters in the wash cabinet .....	88
Activating and setting the interval.....	88
Interface .....	90

Water hardness .....	93
Display: Temperature.....	93
Display brightness and contrast.....	94
Switch off after .....	95
Ready for operation.....	95
Auto-off function .....	95
Switching off after activating.....	96
Factory default.....	97
Software version.....	97
<b>Programme settings</b> .....	98
Adjusting programme settings .....	98
Programme structure.....	98
Programme header.....	98
Programme blocks .....	99
Opening the menu.....	99
Reset programme.....	100
Altering a programme .....	101
Allocating wash blocks.....	101
Spray arm monitoring.....	102
Measuring conductivity .....	104
Change water quantity .....	107
Increasing drainage time .....	108
Setting the concentration level.....	109
Set wash block temperature .....	110
Drying unit .....	112
<b>Process documentation</b> .....	116
Outputting cycle reports retrospectively .....	119
External software.....	119
Report printer .....	119
<b>Maintenance</b> .....	120
Periodic checks .....	120
Routine checks.....	121
Cleaning the filters in the wash cabinet .....	121
Cleaning the spray arms.....	123
Cleaning the machine.....	125
Cleaning the control panel .....	125
Cleaning the door and the door seal.....	125
Cleaning the wash chamber.....	125
Cleaning the door front .....	125
Preventing re-soiling.....	125
Checking mobile units, baskets, modules and inserts.....	126
Filter change.....	127
Changing the coarse filter .....	127
Changing the HEPA filter.....	128
Resetting the operating hours counter.....	129
Performance check .....	130
<b>Problem solving guide</b> .....	133
Technical faults and messages .....	133
Dispensing/Dispensing systems .....	134

# Contents

---

Insufficient salt/Water softener .....	135
Cancel with fault code .....	136
Process-related faults and messages .....	140
Door .....	142
Unsatisfactory cleaning and corrosion .....	142
Spray arm monitoring/conductivity/wash pressure .....	144
Water inlet and drainage .....	146
Noises .....	147
Printer/interface .....	147
<b>Problem solving guide</b> .....	148
Cleaning the drain pump and non-return valve .....	148
Cleaning the water intake filters .....	149
Retrofitting the large-surface filter .....	149
<b>After sales service</b> .....	150
Contacting the Customer Service Department .....	150
Software version .....	151
<b>Installation</b> .....	152
Installation and levelling .....	152
Fitting the lid .....	153
Building under a continuous worktop .....	154
Preventing heat build-up .....	154
Electromagnetic compatibility (EMC) .....	155
<b>Electrical connection</b> .....	156
Equipotential bonding connection .....	156
Peak-load negotiation .....	157
<b>Plumbing</b> .....	158
Connection to the water supply .....	158
Retrofitting the large-surface filter .....	159
Connecting the drain hose .....	161
<b>Technical data</b> .....	162
<b>Programme chart</b> .....	163
General programmes .....	163
Programmes for specific soiling .....	164
Programmes for specific load items .....	164
Additional programmes .....	165
Programme selection depending on the accessories used .....	165
<b>Programme parameters</b> .....	166
Free memory .....	166
Free memory .....	167
Mini .....	168
Standard .....	169
Universal .....	170
Intensive .....	171
Injector plus .....	172
Inorganic .....	173
Organic .....	174

## Contents

---

Oil programme.....	175
Plastics .....	176
Pipettes .....	177
Special 93°C-10' .....	178
<b>Caring for the environment</b> .....	179
Disposal of the packing material .....	179

## Notes about these instructions

---

### Important warnings

 Information which is important for safety is highlighted in a thick framed box with a warning symbol. This alerts you to the potential danger of injury to people or damage to property. Read these warning notes carefully and observe the procedural instructions and codes of practice they describe.

### Notes

Information of particular importance that must be observed is highlighted in a thick framed box.

### Additional information and comments

Additional information and comments are contained in a simple frame.

### Operating steps

Operating steps are indicated by a black square bullet point.

#### Example:

■ Select an option using the arrow buttons and save your choice with *OK*.

### Display

Certain functions are shown in display messages using the same font as that used for the function itself in the display.

#### Example:

Settings  menu.

### Definition of terms

#### Machine

In these operating instructions, the washer-disinfector is referred to as “the machine”.

#### Load items

The term “load items” is used wherever the items to be processed are not defined in any further detail.

#### Wash water

The term “wash water” is used for the mixture of water and process chemicals.



This washer-disinfector is designed to reprocess laboratory glassware, utensils and similarly categorised components using water-based media. These include:

- Vessels such as beakers, flasks, cylinders and test tubes
- Measuring vessels such as measuring cylinders, volumetric flasks and pipettes
- Dishes such as petri dishes and watch glasses
- Plates such as slides and sequencing plates
- Small items such as lids, magnetic stirring rods, spatulas and stoppers
- Other items such as boxes, plastic flasks and containers, metal parts, pipe and hose pieces and funnels

Reprocessing encompasses the cleaning, rinsing, thermal disinfection (where necessary) and drying of the laboratory glassware, utensils and components listed above.

Reprocessing is carried out in conjunction with:

- Process chemicals which are tailored to the result of the reprocessing
- Load carriers which are tailored to the load items

Observe the information issued by the manufacturer of the load items.

The washer-disinfector is designed for use in laboratories (e.g. chemical and biological laboratories in universities, research institutes and industry) as well as laboratory-type applications in the industrial sector.

### **IMPORTANT**

#### **Australia and New Zealand**

This machine is not intended to be used to reprocess or disinfect medical devices or medical equipment.

#### **Inappropriate use**

The washer-disinfector must not be used for any purposes other than the appropriate use described. This applies in particular to:

- The reprocessing of medical devices that can be reprocessed
- Use in the catering industry
- Domestic use

## User profiles

---

### User profiles

#### Daily operators

Daily operators must be instructed in operating and loading the machine and trained regularly to guarantee safe daily use. They require knowledge of machine reprocessing of laboratory glassware and utensils.

Tasks for daily routine operation are located in the Settings  menu. This menu is freely accessible to all users.

#### Administration

More advanced tasks, e.g. interrupting or cancelling a programme, require more detailed knowledge about the machine reprocessing of laboratory glassware and utensils.

Alterations or adaptations of the machine, e.g. accessories used or on-site conditions require additional specific knowledge of the machine.

Validation processes assume specialised knowledge of the machine reprocessing of laboratory glassware and utensils, of the processes involved and of applicable standards and legislation.

Administrative processes and settings are allocated to Further settings. This is protected from unauthorised access by a code.

## Overview

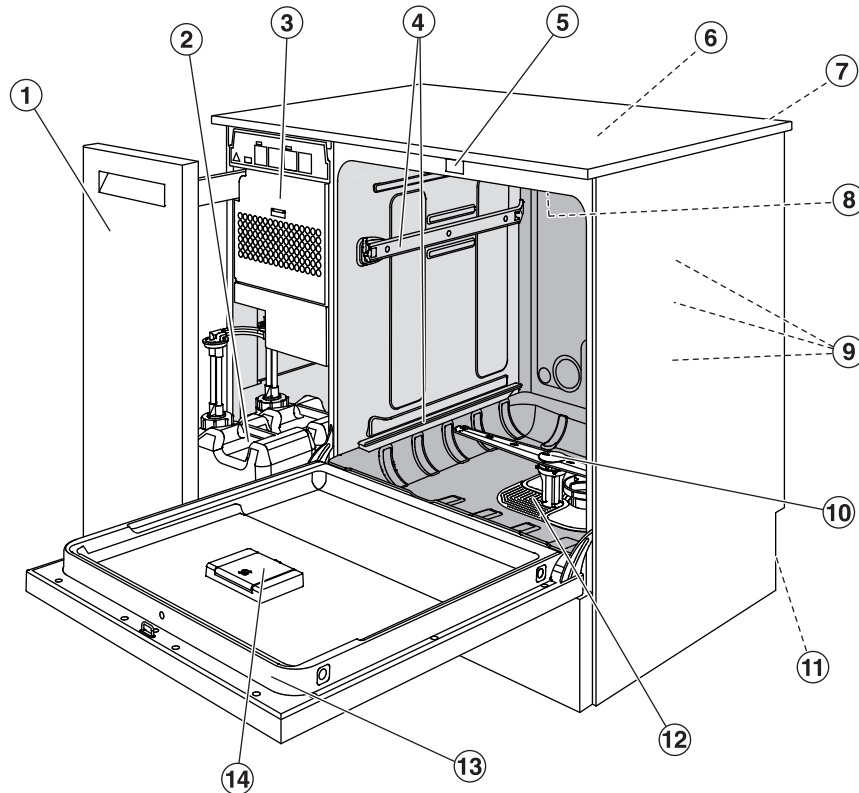

- |                                                                                       |                                                     |
|---------------------------------------------------------------------------------------|-----------------------------------------------------|
| ① Side unit                                                                           | ⑧ Upper machine spray arm                           |
| ② Dispensing containers for chemical agents                                           | ⑨ Plumbing connections for mobile units and baskets |
| ③ Drying unit                                                                         | ⑩ Lower machine spray arm                           |
| ④ Rails for baskets and mobile units                                                  | ⑪ On the back:                                      |
| ⑤ Comfort door locking mechanism                                                      | – Second data plate                                 |
| ⑥ Test point for performance checks (Top, front right; only visible with lid removed) | – Electrical and plumbing connections               |
| ⑦ Module slot for a communication module (Back, top right)                            | ⑫ Filter combination                                |
|                                                                                       | ⑬ Data plate                                        |
|                                                                                       | ⑭ Salt reservoir                                    |



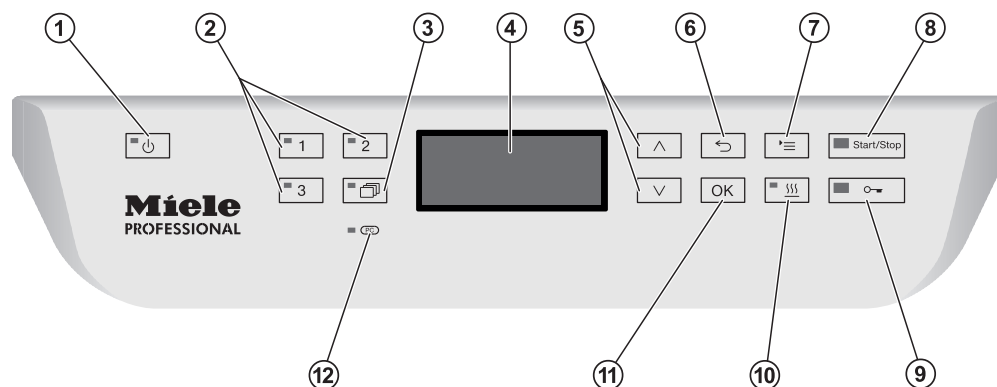



## Control panel



- ① **⏻ button (on/off)**  
For switching the machine on and off.
- ② **[1], [2] and [3] buttons**  
Programme selection buttons.  
The button assignment can be configured.
- ③ **☰ Programme list button**  
For accessing the list of all additional programmes.
- ④ **Display**  
User interface and programme sequence display.
- ⑤ **^ and v arrow buttons**  
For navigating in the user interface.
- ⑥ **↶ Cancel button**  
For cancelling a process in the user interface.  
No programme interruption.
- ⑦ **☰ Settings button**  
For accessing the system settings menu.
- ⑧ **Start/Stop button**  
For starting or cancelling a programme.
- ⑨ **◻→ Door release button**  
For opening the door before or after a programme sequence.
- ⑩ **☄ Drying button**  
For switching drying on and off.
- ⑪ **OK button**  
For selecting or confirming entries in the user interface  
(acknowledge or save).
- ⑫ **Ⓜ Service interface**  
Testing and transmission point for the Customer Service  
Department.

## LEDs in buttons

The buttons on the control panel have LEDs (Light Emitting Diodes). They indicate the status of the machine.

Button	LED	Status
 <b>Button</b>	<b>ON</b>	The machine is switched on.
	<b>FLASHES</b>	The machine is ready for use.
	<b>OFF</b>	The machine is switched off.
<b>Programme selection buttons</b>  ,  and 	<b>ON</b>	The respective programme has been selected. At the end of the programme the LED will remain lit until a different programme is selected.
	<b>OFF</b>	The programme is not selected or the programme settings are being selected.
 <b>Button</b>	<b>ON</b>	A programme has been selected from the programme list. At the end of the programme the LED will remain lit until a different programme is selected.
	<b>OFF</b>	No programme has been selected from the list or the programme settings are being changed.
 <b>Button</b>	<b>ON</b>	The additional “Drying” function has been activated for the selected programme (not available for all programmes; see “Programme overview”).
	<b>OFF</b>	The additional “Drying” function has been deactivated.
<b>Start/Stop button</b>	<b>ON</b>	Programme running.
	<b>FLASHES GREEN</b>	A programme has been selected but not yet started.
	<b>FLASHES RED</b>	A fault has occurred (see “Problem solving guide”).
	<b>OFF</b>	A programme has finished.
 <b>Button</b>	<b>ON</b>	The door is closed (locked) and there is no programme running.
	<b>FLASHES</b>	A programme has finished and the door is closed (locked).
	<b>OFF</b>	A programme is running or the door is open (unlocked).

## Warning and Safety instructions

---

This machine complies with all statutory safety requirements. Inappropriate use can, however, lead to personal injury and material damage.

Read these instructions carefully before using it for the first time to avoid the risk of accidents and damage to the machine.

Keep these instructions in a safe place where they are accessible to users at all times.

### **Correct application**

► Use of the machine is only permitted for the applications expressly approved in the operating instructions. Alterations or conversion of the machine, or using it for purposes other than those for which it was intended, are not permitted and could be dangerous.

The cleaning and disinfection processes are only designed for laboratory glassware and utensils which are designated as reprocessable by the manufacturer. The information provided by the manufacturer of the load items must be observed.

► This machine is intended for indoor use only.

### **Risk of injury**

#### **Please pay attention to the following notes to avoid injury**

► The machine may only be installed, commissioned, repaired and maintained by the Miele Customer Service Department or a suitably qualified service technician. A Miele service contract is recommended to ensure full compliance with the normative and regulatory provisions. Incorrect repairs can cause considerable danger to users.

► Do not install the machine in an area where there is any risk of explosion or of freezing conditions.

► In order to reduce the risk of water damage, the area around the machine should be limited to furniture and fittings that are designed for use in commercial environments.

► Some metal parts pose a risk of injury/being cut. Wear cut-resistant protective gloves when transporting and setting up the machine.

► If the machine is built under, it must only be installed under a continuous worktop run which is firmly secured to adjacent units to improve stability.

► The electrical safety of this machine can only be guaranteed when correctly earthed. It is essential that this standard safety requirement is met. If in any doubt, please have the on-site wiring system tested by a qualified electrician. Miele cannot be held liable for the consequences of an inadequate earthing system (e.g. electric shock).

## Warning and Safety instructions

---

- ▶ A damaged or leaking machine could be dangerous and compromise your safety. Disconnect the machine from the mains immediately and call the Miele Service Department.
- ▶ Label cleaning machines which have been taken out of operation and secure them against being switched on again without authorisation. The cleaning machine may only be put back into operation once it has been successfully repaired by the Miele Customer Service Department or by an appropriately qualified specialist.
- ▶ Personnel operating the machine should be trained regularly. Untrained personnel must not be allowed access to the machine or its controls.
- ▶ Only use process chemicals which have been approved by their manufacturer for the relevant application. The manufacturer of the process chemicals is liable for any negative influences on the material of the load and the machine.
- ▶ Take care when handling chemical agents. These may contain irritant, corrosive or toxic ingredients. Please observe the chemical agent manufacturer's safety instructions and safety data sheets. Wear protective gloves and goggles.
- ▶ The machine is designed for operation with water and recommended additive chemical agents only. Organic solvents and flammable liquid agents must not be used in it. This could cause an explosion, damage rubber or plastic components in the machine and cause liquids to leak out of it.
- ▶ The water in the cabinet must not be used as drinking water.
- ▶ Do not lift the machine by protruding parts such as the control panel or the opened service flap as these could be damaged or torn off.
- ▶ Do not sit or lean on the opened door. This could cause the machine to tip up and be damaged or cause an injury.
- ▶ Be careful when sorting items with pointed ends. Position them in the machine so that you will not hurt yourself or create a danger for others.
- ▶ Broken glass can result in serious injury when loading or unloading. Broken glass items must not be processed in the machine.
- ▶ When using this machine in the higher temperature ranges, be especially careful not to scald or burn yourself or come into contact with irritant substances when opening the door. Where disinfecting agents are used there is a danger of inhaling toxic fumes.

## Warning and Safety instructions

---

- ▶ Should personnel accidentally come into contact with toxic vapours or chemical agents, follow the emergency instructions given in the manufacturer's safety data sheets.
- ▶ Mobile units, baskets, modules, inserts and the load must be allowed to cool down before they are unloaded. Any water remaining in containers could still be very hot. Empty them into the wash cabinet before taking them out.
- ▶ Never clean the machine or near vicinity with a water hose or a pressure washer.
- ▶ The machine must be disconnected from the mains electricity supply before any maintenance or repair work is carried out.
- ▶ There may be a risk of slipping if liquid is spilt on the floor depending on the type of flooring and footwear being worn. Keep the floor dry where possible and take care to clean up any liquid spills straight away. Take the necessary precautions when cleaning up hazardous substances and hot liquids.

### Quality assurance

**The following points should be observed to assist in maintaining quality standards when processing laboratory glassware and utensils to avoid damage to the loads being cleaned.**

- ▶ If it is necessary to interrupt a programme in exceptional circumstances, this may only be done by authorised personnel.
- ▶ The standard of cleaning and disinfection must be routinely confirmed by the user. The process should be validated on a regular basis, and checked against documented control results.
- ▶ For thermal disinfection, use temperatures and temperature holding times to achieve the required infection prophylaxis in accordance with current health and safety regulations.
- ▶ Make sure items being washed are suitable for machine reprocessing and are in good condition. Plastic items must be thermally stable. Nickel plated items and aluminium items can be machine processed using special procedures only. Items containing iron, and soiling containing residual rust must not be placed in the cabinet.
- ▶ Chemical agents can, in certain circumstances, cause damage to the machine. Always follow the recommendations of the chemical agent manufacturer.  
In case of damage or doubt about compatibility, please contact Miele.



## Warning and Safety instructions

---

▶ Cleaning agents containing chlorine can damage the elastomers of the machine.

If the use of cleaning agents containing chlorine is required, a maximum temperature of 75 °C in the “Main wash” programme phases is recommended (see programme chart).

Cleaning agents containing chlorine must not be used in machines supplied (ex works) with special oil-resistant elastomers for oil and grease applications.

▶ Abrasive substances must not be placed in the machine as they could cause damage to the mechanical components of the water supply. Any residues of abrasive substances on items to be washed must be removed without trace before reprocessing in the machine.

▶ Pre-treatments with cleaning or disinfecting agents can create foam, as can certain types of soiling and chemical agents. Foam can have an adverse effect on the cleaning and disinfection result.

▶ Processes must be set up such that foam cannot escape from the wash cabinet. It would hinder the correct functioning of the machine.

▶ The process used must be monitored on a regular basis by the supervisor to check foaming levels.

▶ To avoid the risk of damage to the machine and any accessories used with it caused by chemical agents, soiling and any reaction between the two please read the notes in “Chemical processes and technology”.

▶ Where a chemical agent is recommended on technical application grounds (e.g. a cleaning agent), this does not imply that the manufacturer of the machine accepts liability for the effect of the chemical on the items being cleaned.

Please be aware that changes in formulation, storage conditions etc. which may not be publicised by the chemical manufacturer, can have a negative effect on the cleaning result.

▶ When using process chemicals, always consult the instructions issued by individual manufacturers. Process chemicals must only be used for the purpose they are designed for by the manufacturer to avoid any material damage or the occurrence of very strong chemical reactions (e.g. oxyhydrogen explosion).

▶ Always follow the relevant manufacturer's instructions on storage and disposal of chemical agents.

▶ In critical applications where very stringent requirements have to be met, it is strongly recommended that all the relevant factors for the process, such as chemical agents, water quality etc. are discussed with the Miele Application Technology specialists.

## Warning and Safety instructions

---

- ▶ If the cleaning result is subject to particularly stringent requirements, e.g. in chemical analysis, the operator must carry out regular quality control to ensure that required standards of cleanliness are being achieved.
- ▶ The mobile units, baskets, modules and inserts that hold the load must be used only as intended.  
Hollow items must be thoroughly cleaned, internally and externally.
- ▶ Secure small and light items with cover nets or place in a mesh tray for small items, so that they do not block the spray arms.
- ▶ Empty any containers or utensils before loading them.
- ▶ The amount of residual solvents and acids on items going into the cabinet should be minimal.  
There should be no more than a trace of any solvents with a flash point of below 21 °C.
- ▶ Chloride solutions, in particular hydrochloric acid, must not be placed in the cabinet.
- ▶ Ensure that solutions or steam containing chlorides or hydrochloric acid do not come into contact with the stainless steel outer casing of the machine in order to avoid any damage through corrosion.
- ▶ After any plumbing work the water pipework to the machine will need to be vented. If this is not done, components can be damaged.
- ▶ The gaps between a built-in machine and adjacent cabinetry must not be filled e.g. with silicone sealant as this could compromise the ventilation to the circulation pump.
- ▶ Follow the installation instructions in the operating and installation instructions.

### **Safety with children**

- ▶ Children must be supervised in the vicinity of the machine. Do not allow children to play with the machine. They could get locked inside it.
- ▶ Children must not use the machine.
- ▶ Keep children away from chemical agents. These can cause burning in the mouth, nose and throat if swallowed, or inhibit breathing. Keep children away from the machine when the door is open. There could still be residual chemical agent in the cabinet. Observe the safety data sheets for the chemical agent and seek medical advice immediately if a child has swallowed chemical agent or got it in the eyes.

## Use of components and accessories

- ▶ Only Miele accessories should be connected to this machine. They must be suitable for the application they are required for. Consult Miele for details on the type of accessories that can be used.
- ▶ Only use Miele mobile units, baskets, modules and inserts with this washer-disinfector. Using mobile units, baskets, modules and inserts made by other manufacturers, or making modifications to Miele accessories can cause unsatisfactory cleaning results, for which Miele cannot be held liable. Any resultant damage would not be covered by the guarantee.

## Symbols on the machine

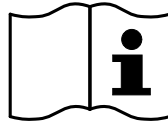

Warning:  
Observe the operating instructions!

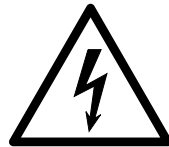

Warning:  
Danger of electric shock!



Warning: Hot surfaces:  
It can be very hot inside the wash cabinet when the door is opened!



Risk of being cut:  
Wear cut-resistant protective gloves when transporting and setting up the machine!

## Disposing of your old machine

- ▶ Please note that the machine may have contamination from blood, bodily fluids, pathogenic germs, facultative pathogenic germs, genetically modified material, etc. in it and must be decontaminated before disposal.

For environmental and safety reasons ensure the machine is completely drained of any residual water, chemical residues and cleaning agent. Observe safety regulations and wear safety goggles and gloves.

Make the door lock inoperable, so that children cannot accidentally shut themselves in. Then make appropriate arrangements for its safe disposal.

# Using the machine

## Control panel

The machine is operated exclusively by the buttons located on the stainless steel surfaces either side of the display. The display is not a touch screen.

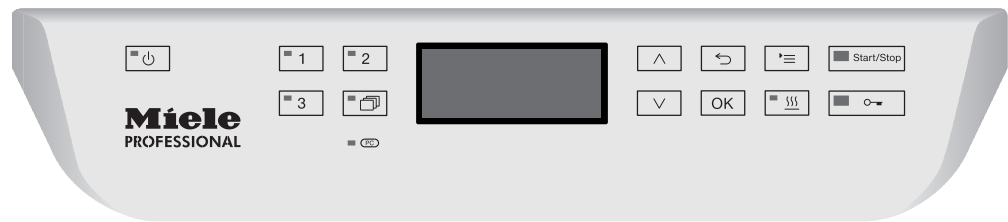



A light touch on the relevant button is sufficient to operate the functions. The buttons can also be pressed and held for approx. 20 seconds.

## Display illustrations

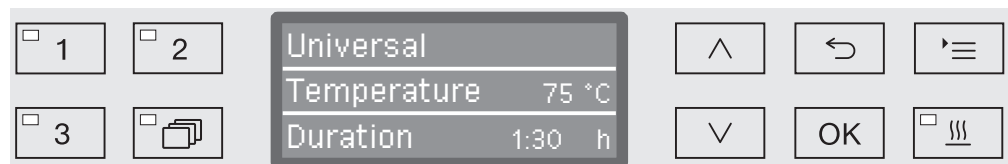
All display illustrations shown in these operating instructions are examples which may differ from the actual display screens shown on the machine.



The control buttons are shown next to the display. The , , and *Start/Stop* buttons are not shown.

## Switching on

The machine must be connected to the electrical supply.

- Press the  button until the button's LED lights up.

After that, the display shows the following:



As soon as the machine is ready for operation, the display changes to show the last selected programme, e.g.:

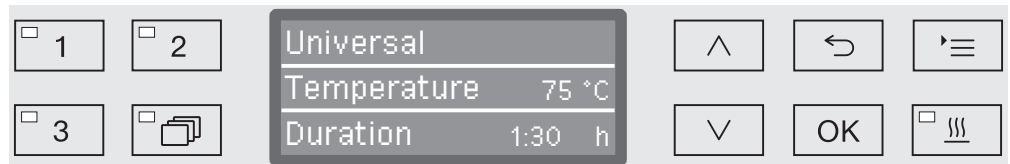

If the machine is being used for the first time, or if the factory default settings have been reinstated, some basic parameters, e.g. language, date, time, etc., must first be set. To enable this, the display automatically changes to the relevant screen.

## Switching off

- Press the  button.

## Auto-off function

To save energy, the machine has an automatic switch-off function (Auto-off function). If the machine has not been used for a specific time period, it switches itself off automatically, see “Further settings/ Switch off after”.

- Use the  button to switch the machine on again.

## Ready for use

When it is ready for use, the machine remains switched on, the  button flashes and the time is shown on the display. Pressing any button reactivates the machine. Standby can be switched on and off as required, see “Further settings/Switch off after”.

# Using the machine

---

## Display interface

The machine is controlled by menus. The menus are displayed in a 3-line display on the control panel.

The name of the menu (top line) and up to two options are shown. The currently selected option is highlighted, e.g.

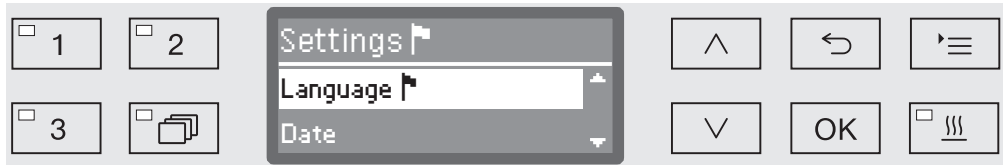

## Menu operation



### Settings button

For accessing the system settings menus.



### Arrow buttons

The arrow buttons are used to navigate up and down by row within a menu. Press and hold the button to automatically scroll through the list to the end of the menu. Press the button again to continue navigating.

Parameter values can also be altered in defined increments using the arrow buttons. Instructions for this can be found in the relevant sections.



### OK button

The *OK* button is used for confirming (acknowledging) a selection or for saving input. The display then moves to the next menu or, when entering parameter values, to the next input position. Instructions for this can be found in the relevant sections.



### Cancel button

Before the *OK* button has been pressed, a process can be cancelled at any time by pressing the  button. The menu is then ended early and the display changes to the next menu level up. Any setting changes made will not be saved.

## Settings in the menu

All menu descriptions in these operating instructions are structured as follows:

### Input procedure

The input procedure describes the complete sequence required to reach a particular menu level. The menu options shown must be selected individually using the arrow buttons and then confirmed with *OK*.

Example:

'≡ button  
▶Settings |  
▶Time of day  
▶Clock display

If a menu level is already displayed, the path does not need to be input completely. If, for example, the Settings | menu is already displayed, you do not need to press the '≡ button again. In this case simply follow the sequence from Settings | onwards.

### Display view

When selecting a menu, the last menu used is generally opened.

Example:



### Options

All available menu options are listed together with a short description.

Example:

- 12 h  
Time of day display in 12 hour format (am/pm).
- 24 h  
Time of day in 24 hour format.

### Method

Then further instructions are given.

Example:

- Select an option using the ^ and v arrow buttons.
- Press *OK* to save the setting.

## Using the machine

### Symbols on the display

- ◆ **Navigation arrows**

If a menu consists of more than two options, two navigation arrows are shown at the side of the menu options.



Use the  $\wedge$  and  $\vee$  arrow buttons on the control panel to navigate through the menu.

- - - - - **Dotted line**

If a menu contains more than two options, the end of the option list is marked by a dotted line. The last entry appears above the line, the first entry below it.

- ✓ **Tick**

If there are several options available, the current setting is marked with a tick ✓.

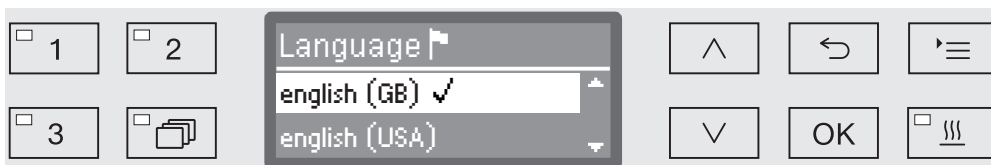

- i** **System messages**

The **i** symbol denotes system messages. These give information, such as a notification of an excessively low level in the supply containers or a reminder for the next service.

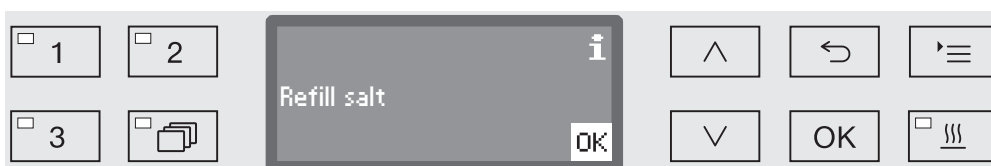

System messages are displayed at the start and end of a programme and have to be confirmed (acknowledged) individually with **OK** or all together at the end of the programme by opening the door. If the **i** symbol is shown on the display, the system messages can be opened by pressing the **OK** button.

- ⚠ **Fault messages**

In the event of a fault a warning triangle is shown in place of the **i** symbol. See “Problem solving guide” and “After sales service” for more information.



## Installation and connection

Before commissioning the machine must be securely installed, and the water inlet and drain hoses and the mains cable correctly connected. See “Installation”, “Plumbing connections” and “Electrical connection” and the installation diagram supplied.

## Procedure

During commissioning a set procedure is followed which must not be interrupted. The display will automatically guide you through the process.

All settings, except for selecting plumbing connections, can be retrospectively altered via the Settings  and Further settings menus.

The settings made during the commissioning process are only adopted after a complete programme has been run. If the programme is interrupted or if no programme is started and the machine is switched off, the commissioning process must be carried out again.

### Switching on

- Press the  button until the LED lights up.

### Select language

The commissioning process starts with selecting the language.

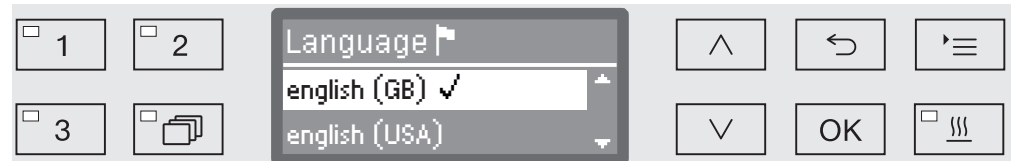

- Use the  $\wedge$  and  $\vee$  arrow buttons to select the language you want and touch *OK* to save.

### Select temperature unit

The menu for selecting the temperature unit will then appear.

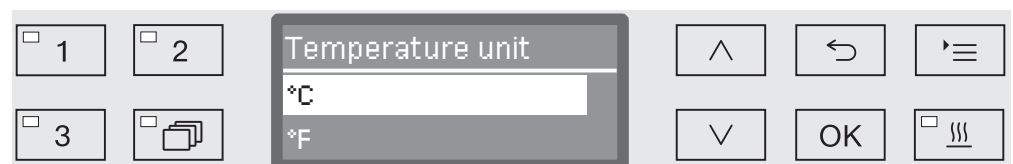

- Use the  $\wedge$  and  $\vee$  arrow buttons to select the temperature unit you want and touch *OK* to save.

# Commissioning

## Select the date format

The menu for selecting the date format will then appear.



- DD = Day
- MM = Month
- YY = Year

- Use the  $\wedge$  and  $\vee$  arrow buttons to select the date format you want and touch *OK* to save.

## Set the date

The menu for setting the date will then appear.

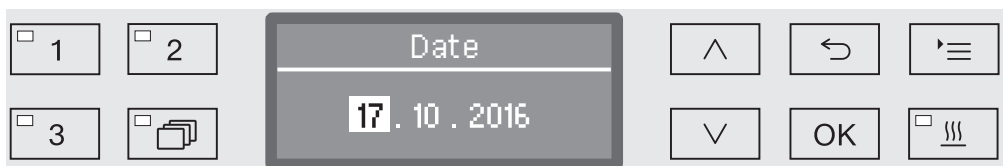

- Use the  $\wedge$  and  $\vee$  arrow buttons to set the day, month and year and touch *OK* to save each one.

## Select Clock display

The menu for selecting the clock format will then appear.



- Use the  $\wedge$  and  $\vee$  arrow buttons to select the format you want and touch *OK* to save.

## Set the time of day

The menu for setting the display for the time of day will then appear.

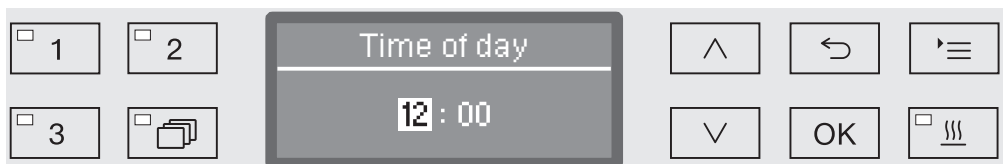

- Use the  $\wedge$  and  $\vee$  arrow buttons to select the hours and minutes and touch *OK* to save each one.

## Setting the water hardness level

The menu for setting the water hardness will then appear.

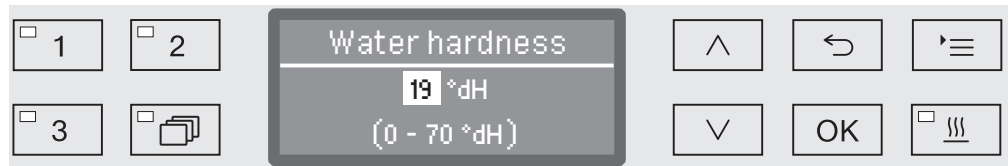

The possible range is shown in the bottom line of the display. Water hardness setting values can be found in the “Water softener/Settings” chart.

Your local water authority can give you information about the exact water hardness in your area.

Where the water hardness fluctuates, e.g. between 1.4 – 3.1 mmol/l (8 – 17 °dH), always programme the machine to the higher value, 3.1 mmol/l (17 °dH) in this example.

- Set the water hardness using the arrow buttons  $\wedge$  (higher) and  $\vee$  (lower) and touch *OK* to save.
- Write down the water hardness in “Water softener/Water hardness”.

## Select plumbing connections

The menu for setting plumbing connections will then appear.

Unused plumbing connections, e.g. if there is only one connection, can be deactivated here.

Following commissioning the plumbing connections can be reinstated by Miele Service.



The plumbing connection is set via multiple choice. A box  is shown in the display next to all plumbing connections. If the connection is activated, a tick  can be seen in it. Select to activate or deactivate the plumbing connections.

- Use the  $\wedge$  and  $\vee$  arrow buttons to select the plumbing connection you want. Plumbing connections are activated or deactivated by touching *OK*.
- To save the selection select the *Accept* option at the end of the list and confirm with *OK*.

# Commissioning

## Commissioning completed

Commissioning is completed when the following message is displayed.

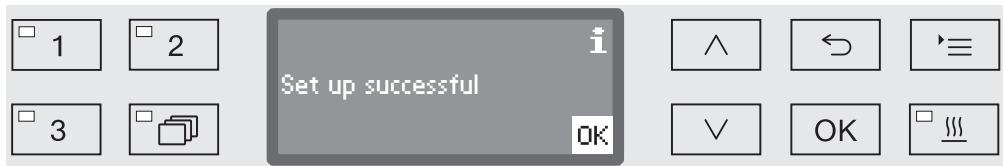

- Confirm the message with *OK*.

The washer-disinfector is now ready for use.

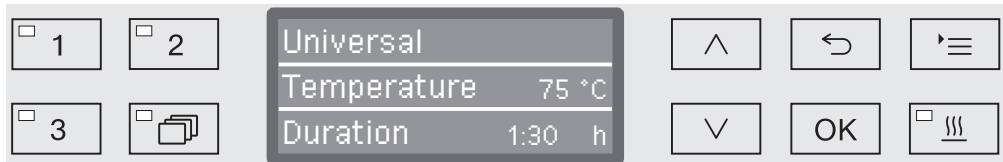

The settings made during the commissioning process are only adopted after a complete programme has been run.

- Select any programme, e.g.: Drain.
- Press the *Start/Stop* button to start the programme.

After commissioning, every programme starts with reactivation of the water softener.

## Fault 420

If the programme is cancelled using Fault 420, this means that all the plumbing connections are deactivated.

- Confirm the error message with *OK*.
- Switch the machine off using the  $\text{⏻}$  button.
- Wait approximately 10 seconds before switching the machine on again with the  $\text{⏻}$  button.

The commissioning procedure starts again.



- Perform commissioning and activate at least one plumbing connection; e.g. for cold water.

### Electronic door locking

The washer-disinfector is equipped with a Comfort door lock. When the door is closed, the Comfort door lock automatically pulls the door into the correct position and ensures that it is correctly sealed. The door is then electronically locked.

### Opening the door

An electronically locked door can only be opened if:

- the washer-disinfector is connected to the electrical supply and is switched on (the  button's LED is lit up),
- there is no programme running,
- the temperature in the wash cabinet is less than 60 °C and
- the  LED is lit up.

- Press the  button to open the door.

The Comfort door lock opens the door slightly. The LED goes out as soon as the door is unlocked.

The control panel of the machine is also a door handle.

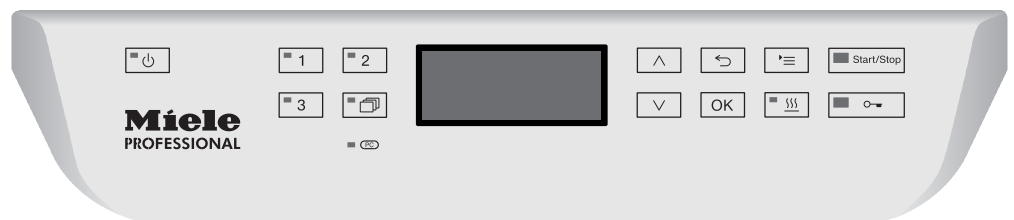

- Grasp the handle underneath the control panel and lower the door to open it.

### Closing the door

- Ensure that there are no objects or items in the load obstructing the door.

 Do not put your hand inside the door as it is closing.  
Danger of injury.

- Lift the door until it engages with the door lock. The door is automatically pulled into the correct position by the Comfort door lock.

## Opening and closing the door

### Opening the door using the emergency release

The emergency release may only be used when it is no longer possible to open the door normally, e.g. in the event of a power cut.

⚠ If the emergency release is operated during a programme cycle, hot water and cleaning agents can escape.  
Risk of scalding, burning and chemical burns.

- Push against the door so that less force is needed to operate the emergency release.

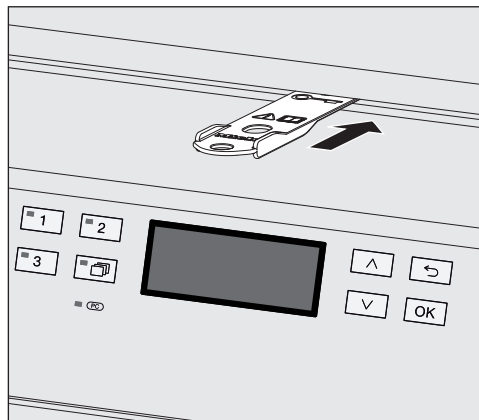

- Push the tool supplied in the accessory pack horizontally into the gap between the door and the lid or worktop. The right hand edge of the tool must align with the outer right hand edge of the display.
- Press against the unlocking mechanism with the tool until you hear the door unlock. The door can now be opened.

If the washer-disinfector is switched on, activation of the emergency release will be recorded in the process documentation and the following message will appear in the display:



The message remains in the display until the door is closed. It is not recorded if the machine is switched off.

### Water hardness

In order to achieve good cleaning results, the machine needs to operate with soft water. Hard water results in the build-up of calcium deposits on the load and in the machine.

Mains water with a water hardness of 0.7 mmol/l (4 °dH) must be softened. This occurs automatically in the built-in water softener. The water softener must be set to the exact hardness of the mains water (see “Water softener/Setting the water hardness”).

Your local water authority will be able to tell you the exact degree of hardness in the mains water supply.

For future servicing it is useful to make a note of your water hardness level. Enter your water hardness level here:

\_\_\_\_\_ mmol/l or °dH

The water softener must be reactivated at regular intervals. This requires special reactivation salt (see “Water softener/Filling the salt reservoir”). Reactivation is carried out automatically during a programme sequence.

If the hardness level of your water is constantly less than 0.7 mmol/l (= 4 °dH), salt is not required for the water softener. The water hardness level must, however, still be set.

# Water softener

---

## Setting the water hardness level

Water hardness can be set between 0 and 12.6 mmol/l (0 - 70 °dH).

- Open the menu as follows:

☰ button

▶ Further settings

▶ Water hardness



The bottom line of the display shows the possible input range. Water hardness input values can be found in the chart on the next page.

Where the water hardness fluctuates, e.g. between 1.4 - 3.1 mmol/l (8 - 17 °dH), always programme the machine to the higher value, 3.1 mmol/l (17 °dH) in this example.

- Set the water hardness level using the arrow buttons (∧ = higher and ∨ = lower).
- Press *OK* to save the setting.



## Settings

°dH	°f	mmol/l	Display
0	0	0	<b>0</b>
1	2	0.2	<b>1</b>
2	4	0.4	<b>2</b>
3	5	0.5	<b>3</b>
4	7	0.7	<b>4</b>
5	9	0.9	<b>5</b>
6	11	1.1	<b>6</b>
7	13	1.3	<b>7</b>
8	14	1.4	<b>8</b>
9	16	1.6	<b>9</b>
10	18	1.8	<b>10</b>
11	20	2.0	<b>11</b>
12	22	2.2	<b>12</b>
13	23	2.3	<b>13</b>
14	25	2.5	<b>14</b>
15	27	2.7	<b>15</b>
16	29	2.9	<b>16</b>
17	31	3.1	<b>17</b>
18	32	3.2	<b>18</b>
<b>19</b>	<b>34</b>	<b>3.4</b>	<b>19 *)</b>
20	36	3.6	<b>20</b>
21	38	3.8	<b>21</b>
22	40	4.0	<b>22</b>
23	41	4.1	<b>23</b>
24	43	4.3	<b>24</b>
25	45	4.5	<b>25</b>
26	47	4.7	<b>26</b>
27	49	4.9	<b>27</b>
28	50	5.0	<b>28</b>
29	52	5.2	<b>29</b>
30	54	5.4	<b>30</b>
31	56	5.6	<b>31</b>
32	58	5.8	<b>32</b>
33	59	5.9	<b>33</b>
34	61	6.1	<b>34</b>
35	63	6.3	<b>35</b>

°dH	°f	mmol/l	Display
36	65	6.5	<b>36</b>
37	67	6.7	<b>37</b>
38	68	6.8	<b>38</b>
39	70	7.0	<b>39</b>
40	72	7.2	<b>40</b>
41	74	7.4	<b>41</b>
42	76	7.6	<b>42</b>
43	77	7.7	<b>43</b>
44	79	7.9	<b>44</b>
45	81	8.1	<b>45</b>
46	83	8.3	<b>46</b>
47	85	8.5	<b>47</b>
48	86	8.6	<b>48</b>
49	88	8.8	<b>49</b>
50	90	9.0	<b>50</b>
51	92	9.2	<b>51</b>
52	94	9.4	<b>52</b>
53	95	9.5	<b>53</b>
54	97	9.7	<b>54</b>
55	99	9.9	<b>55</b>
56	100	10.0	<b>56</b>
57	102	10.2	<b>57</b>
58	104	10.4	<b>58</b>
59	106	10.6	<b>59</b>
60	107	10.7	<b>60</b>
61	109	10.9	<b>61</b>
62	111	11.1	<b>62</b>
63	113	11.3	<b>63</b>
64	115	11.5	<b>64</b>
65	116	11.6	<b>65</b>
66	118	11.8	<b>66</b>
67	120	12.0	<b>67</b>
68	122	12.2	<b>68</b>
69	124	12.4	<b>69</b>
70	125	12.5	<b>70</b>

\*) Factory default setting

## Filling the salt reservoir

Use only special, coarse-grained reactivation salt with a granule size of approx. 1 - 4 mm.

Do not under any circumstances use other types of salt such as table salt, agricultural or gritting salt. These may contain insoluble additives which can impair the functioning of the water softener.

⚠ Inadvertently filling the salt reservoir with cleaning agent will cause serious damage to the water softener.

Before filling the salt container make sure that you have picked up the right packet of reactivation salt.

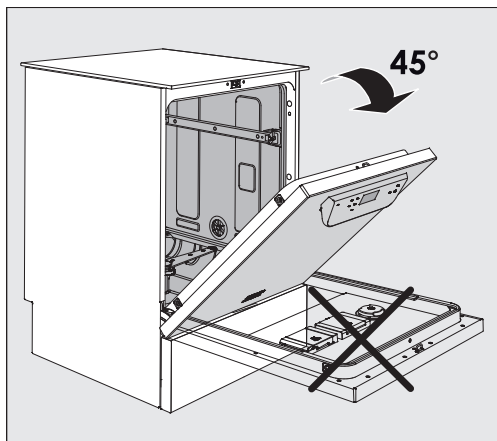

- Open the door to an angle of around 45°. This ensures that the salt flows into the container more easily.

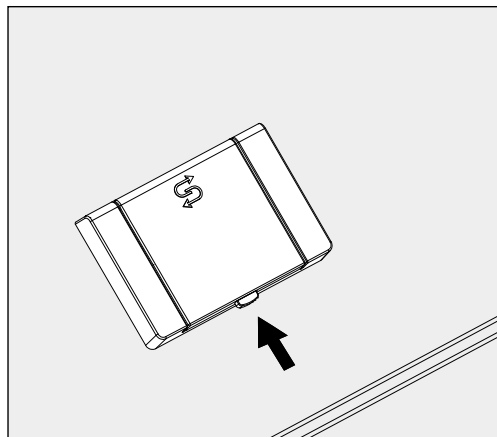

- Press the yellow button with the  symbol on the salt container in the direction of the arrow. The flap will spring open.
- Open the funnel.

The container takes approx. 1.4–2 kg of salt, depending on the type of salt and the remaining fill level.

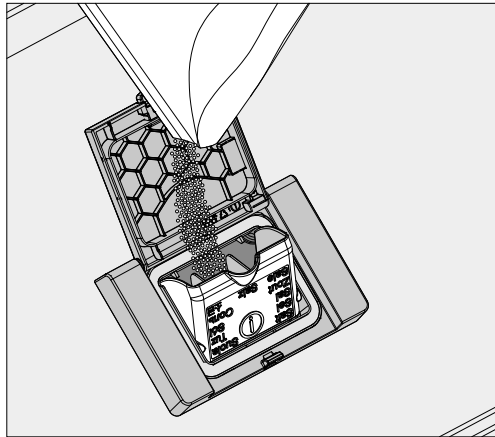

⚠ Never fill the container with water.  
The container could overflow when filled with salt.

- Add salt into the container until the funnel is full but still closes easily. Do not add any more than 2 kg of salt.

As the salt container is being filled, displaced water (brine) may run out.

- Clean any excess salt from around the opening of the container, focusing especially on the container's seal. Do **not** use running water to rinse away salt residues as this can cause the container to overflow.
- Close the container.

⚠ Do not force the container shut if it has been overfilled.  
If an overfilled salt container is forced shut, this may damage the container.  
Remove excess salt before closing the container.

- Run the Rinsing programme after refilling the salt.

This will ensure that any traces of salt and brine are dissolved, diluted and rinsed away.

Excess salt and brine which has overflowed can cause corrosion damage if they are not rinsed away.

# Water softener

---

## Add salt reminder

If the salt level in the reservoir is low, the following reminder will appear:

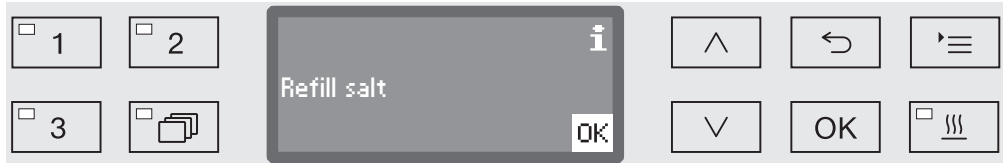

- Confirm the message with the *OK* button and
- fill the reservoir as described.

When the message first appears, there may be sufficient salt for a further programme, depending on the water hardness level set.

If there is no saline solution left in the water softener, a relevant message will appear in the display and the machine will be locked for further use.

The machine can be used again a few seconds after the salt has been refilled.

### Mobile units, baskets, modules and inserts

This machine can be equipped with an upper and lower basket or a mobile unit which can be fitted with different inserts and modules or exchanged for special accessories depending on the items to be washed.

Select accessories which are appropriate for the application.

Information on the individual areas of application can be found on the following pages, as well as in the operating instructions for the mobile units, baskets, modules and inserts (if available).

For all areas of application defined in “Intended use” Miele offers suitable accessories such as mobile units, baskets, modules and inserts and special fittings. Contact Miele for more information.

### Water supply

Mobile units and baskets with spray arms or other rinse fittings are equipped with one or more connection points to the water supply. When loading baskets, mobile units, etc into the machine, connect these to the water connection points in the back panel of the wash cabinet. The mobile units and baskets are held in place by the wash cabinet door when closed.

Any free connections in the back panel are closed mechanically.

### Older models of mobile units and baskets

Only use older models of mobile units and baskets in this machine in consultation with Miele. In particular mobile units and baskets with water supply pipes for spray arms and injector manifolds must be converted to the new type of water connector. Conversion must be carried out by Miele Service and is only available for selected models.

 The fitting of connectors for the water supply of mobile units and baskets must be carried out by Miele Service. Fitting faults on mobile units and baskets can cause damage to the machine.

Following conversion, mobile units and baskets can no longer be used in older models of the machine.

## Areas of application

---

### Adjusting the upper basket

Height-adjustable upper baskets can be adjusted between three positions with 2 cm between each position to accommodate items of different heights.

To adjust the height, the brackets with rollers on the side of the upper basket and the water connector at the back of the basket have to be moved. The roller brackets are each secured to the upper basket by two screws. The water connector consists of the following components:

- A stainless steel plate with 2 apertures,
- a plastic connection piece and
- 6 screws.

Only adjust the upper basket horizontally. The baskets are not designed to be positioned on a slant (one side up, one side down). Altering the height will alter loading heights for both the upper and lower baskets.

#### To adjust the upper basket:

- Remove the upper basket by pulling it out until a resistance is felt and lifting it off the runners.
- Unscrew the roller brackets and the water connector.

#### To adjust the upper basket to the ...

#### ... Upper position:

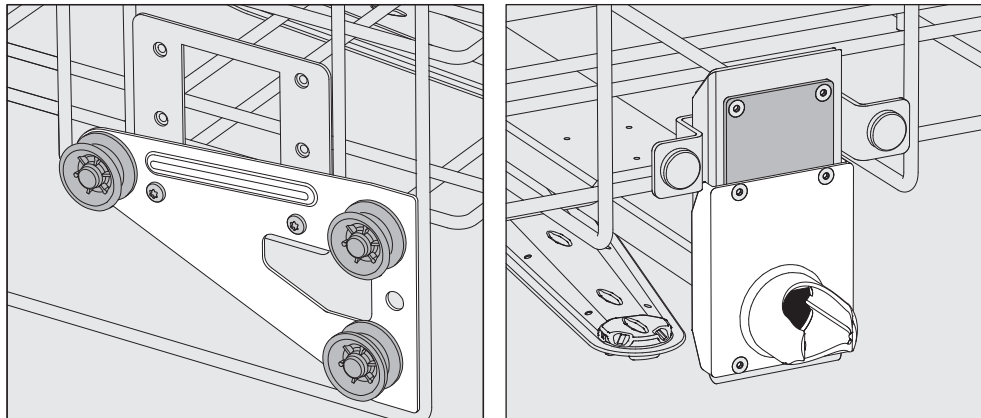

- Move the roller brackets on both sides to the lower position and secure them firmly.
- Position the stainless steel plate over the openings in the water supply pipe so that the upper aperture is covered. Secure the stainless steel plate at the top with 2 screws. Place the water connector in the lower aperture of the stainless steel plate so that the middle aperture is covered. Secure the water connector with 4 screws.

... Middle position:

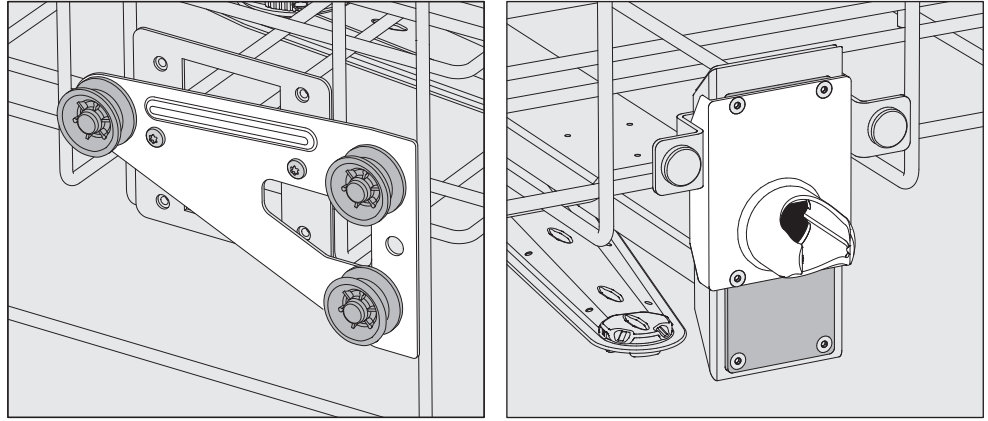

- Move the roller brackets on both sides to the middle position and secure them firmly.
- Position the stainless steel plate over the openings in the water supply pipe so that one of the outer apertures is covered. Secure the stainless steel plate at the top or bottom with 2 screws. Place the water connector in the middle aperture of the stainless steel plate so that the outer aperture is covered. Secure the water connector with 4 screws.

... Lower position:

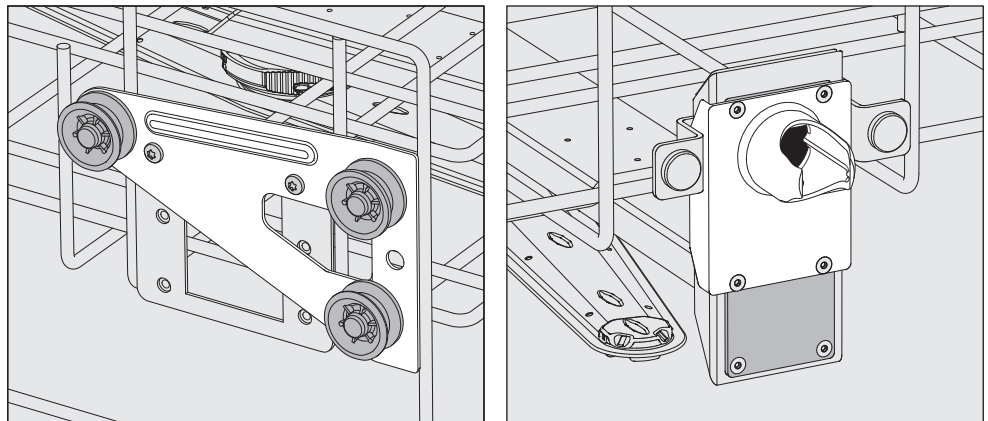

- Move the roller brackets on both sides to the top position and secure them firmly.
- Position the stainless steel plate over the openings in the water supply pipe so that the lower aperture is covered. Secure the stainless steel plate at the bottom with 2 screws. Place the water connector in the upper aperture of the stainless steel plate so that the middle aperture is covered. Secure the water connector with 4 screws.

Then check:

- Replace the upper basket on the rails and push it in carefully to check that the water connector is positioned correctly.

### Preparing the load

⚠ Only items which have been declared by their manufacturer as suitable for machine reprocessing may be processed. The manufacturer's specific reprocessing instructions must be observed.

Special injector nozzles, irrigation sleeves or adapters may be required for appropriate internal cleaning, depending on the load. These, together with other accessories, are available from Miele.

- Arrange the load so that water can access all surfaces. This ensures that it gets properly cleaned.
- Do not place items to be cleaned inside other pieces where they may be concealed.
- Hollow items must be thoroughly cleaned, internally and externally.
- Ensure that items with long narrow hollow sections can be flushed through properly before placing them in a fitting or when connecting them to a water connection.
- Hollow containers should be inverted and placed in the correct mobile units, baskets, modules and inserts, to ensure that water can flow in and out of them unrestricted.
- Deep-sided items should be placed at an angle to make sure water runs off them freely.
- Tall, narrow, hollow items should be placed in the centre of the baskets or mobile units. This ensures better water coverage.
- Take apart any items which can be dismantled according to the manufacturer's instructions and process the individual parts separately from each other.
- Lightweight items should be secured with a cover net (e.g. a A 6) and small items placed in a mesh tray to prevent them blocking the spray arms.
- The spray arms must not be blocked by items which are too tall or which hang down in their path.
- Broken glass can result in serious injury when loading or unloading. Broken glass items must not be processed in the machine.
- Nickel and chrome-plated items, and items made of aluminium, require special procedures and are not generally suitable for machine reprocessing. They require special processing conditions.
- With items which are made entirely or partly of plastic, observe the maximum thermal stability for the items and select an appropriate programme or adjust the temperature of the programme.

Observe the further information given in the following sections as necessary depending on area of application.



### Preparing the load

- Empty all containers before loading into the machine (paying particular attention to relevant regulations).
- Remove non-water soluble residues such as paint, adhesives and polymer compounds using appropriate solvents.
- Rinse wash load items which have been in contact with chloride solutions or hydrochloric acid thoroughly with water before loading in the machine and drain well.

⚠ The amount of residual solvents and acids on items going into the cabinet should be minimal.  
There should be no more than a trace of any solvents with a flash point of below 21 °C.

⚠ Chloride solutions, in particular hydrochloric acid, must not be placed in the cabinet.

- Scoop nutrient media (Agar) out of petri dishes.
- Shake out any blood residues and remove any clots.
- If necessary rinse the wash load briefly with water to prevent coarse soiling entering the machine.
- Remove stoppers, corks, labels, sealing residues, etc.
- Secure small items, such as stoppers and taps in suitable baskets for small items.

It may be necessary in individual cases to check whether extremely stubborn contamination e.g. vacuum grease, paper labels, etc. which could affect the cleaning result, must be removed in advance.

It must be determined whether wash load items which are contaminated with microbiological material, pathogenic germs, facultative pathogenic bacteria, genetically modified material etc. need to be sterilised prior to machine reprocessing.

## Areas of application

---

### **Carry out a visual check before starting every programme:**

- Is everything correctly loaded/connected for cleaning?
- Was the recommended loading template followed?
- Can the lumen / narrow sections of hollow items be accessed by the wash fluid?
- Are the spray arms clean and do they rotate freely?
- Are the filters clean?  
Remove any coarse soiling and clean them if necessary.
- Are the removable modules, injector nozzles, irrigation sleeves and other rinsing fittings securely connected?
- Are the baskets and modules or mobile units correctly connected to the water supply and are the water connectors undamaged?
- Are all chemical containers sufficiently filled?

### **The following must be checked at the end of every programme:**

- Carry out a visual check of the load for cleanliness.
- Check that all hollow items are still securely located on their injector nozzles.

 Any hollow items that have become disconnected from their fittings during reprocessing must be reprocessed.

- Check that the lumen of hollow items are free of obstruction.
- Check that injector nozzles and connectors are securely held in position in the baskets or inserts.

### Wash load...

#### ...wide necked

Wash load items with wide necks, e.g. beakers, wide necked Erlenmeyer flasks and petri dishes, or cylindrical items, e.g. test tubes, can be cleaned inside and out by rotating spray arms. To do this the wash load is positioned in full, half or quarter inserts and placed in an empty lower basket or an upper basket with a spray arm.

#### ...narrow necked

Baskets with special injector modules are available for wash load items with narrow necks, e.g. narrow necked Erlenmeyer flasks, round bottomed flasks, measuring flasks and pipettes.

The injector units and modules come with their own operating instructions.

### When loading please note:

- Place petri dishes in the appropriate insert with the dirty side facing towards the middle.
- Place pipettes with the pointed end facing downwards.
- Quarter segment inserts should be positioned at a minimum 3 cm distance from the edge of the upper or lower basket.
- Position quarter segment inserts for test tubes around the middle to leave the corners of the upper or lower basket free.
- Use a cover net to avoid breakages if required.

## Chemical processes and technology

In this section, you will find a description of the causes of common chemical reactions which can occur between different types of soiling, process chemicals and the components of the machine, along with their remedies as necessary.

This section is intended as a guide. If unforeseen interactions occur during reprocessing or if you have any queries on this subject, please seek advice from Miele.

General information	
Problem	Measures
<p>If elastomers (hoses and seals) and plastics in the cleaning machine are damaged, for example by swelling, shrinking, hardening or brittleness of materials, tears and cracks, components will not function correctly and this generally leads to leaks.</p>	<ul style="list-style-type: none"> <li>- Determine and remedy the causes of the damage.</li> </ul> <p>See also the information on “Process chemicals”, “Soiling” and “Reaction between process chemicals and soiling” in this section.</p>
<p>A heavy build-up of foam during the programme sequence will impair the cleaning and rinsing effect on the load items. Foam escaping from the wash cabinet can cause damage to the cleaning machine.</p> <p>When foam develops, the cleaning process cannot be guaranteed to be standardised and validated.</p>	<ul style="list-style-type: none"> <li>- Determine and remedy the causes of the foam.</li> <li>- Check the process used regularly to monitor foaming levels.</li> </ul> <p>See also the information on “Process chemicals”, “Soiling” and “Reaction between process chemicals and soiling” in this section.</p>
<p>Corrosion of stainless steel in the wash cabinet and of accessories can affect their appearance:</p> <ul style="list-style-type: none"> <li>- Rust (red stains/discolouration)</li> <li>- Black stains/discolouration</li> <li>- White stains/discolouration (etched surface)</li> </ul> <p>Corrosive pitting can lead to the machine not being water-tight. Depending on the application, corrosion can affect cleaning and rinsing results (laboratory analysis) or cause corrosion of (stainless steel) load items.</p>	<ul style="list-style-type: none"> <li>- Determine and remedy the causes of corrosion.</li> </ul> <p>See also the information on “Process chemicals”, “Soiling” and “Reaction between process chemicals and soiling” in this section.</p>

## Chemical processes and technology

<b>Process chemicals</b>	
<b>Problem</b>	<b>Measures</b>
<p>The ingredients in process chemicals have a strong influence on the longevity and functionality (throughput) of the dispensing system.</p>	<ul style="list-style-type: none"> <li>- Follow the process chemical manufacturer's instructions and recommendations.</li> <li>- Carry out a regular visual check of the dispensing system (suction lances, hoses, dispenser canisters, etc.) for any damage.</li> <li>- Regularly check the flow rate of the dispensing system.</li> <li>- Ensure that the regular cycle of maintenance is observed.</li> <li>- Please contact Miele for advice.</li> </ul>
<p>Process chemicals can damage elastomers and plastics in the cleaning machine and accessories.</p>	<ul style="list-style-type: none"> <li>- Follow the process chemical manufacturer's instructions and recommendations.</li> <li>- Carry out a regular visual check of any accessible elastomers and plastics for damage.</li> </ul>
<p>Hydrogen peroxide can release large amounts of oxygen.</p>	<ul style="list-style-type: none"> <li>- Use only validated processes.</li> <li>- The wash temperature must be lower than 70 °C when using hydrogen peroxide.</li> <li>- Please contact Miele for advice.</li> </ul>
<p>The following process chemicals can cause large amounts of foam to build up:</p> <ul style="list-style-type: none"> <li>- Cleaning agents and rinsing agents containing surfactants</li> </ul> <p>Foam can occur:</p> <ul style="list-style-type: none"> <li>- In the programme block in which the process chemical is dispensed</li> <li>- In the following programme block if it has been spilt</li> <li>- In the following programme with rinsing agent if it has been spilt</li> </ul>	<ul style="list-style-type: none"> <li>- The process parameters in the wash programme, such as dispensing temperature, dosage concentration, etc., must be set to ensure the whole process is foam-free or very low-foaming.</li> <li>- Please observe the process chemical manufacturer's instructions.</li> </ul>

## Chemical processes and technology

Process chemicals	
Problem	Measures
<p>De-foaming agents, especially silicone-based ones, can cause the following:</p> <ul style="list-style-type: none"> <li>- Deposits to build up in the wash cabinet</li> <li>- Deposits to build up on the load items</li> <li>- Damage to elastomers and plastics in the machine</li> <li>- Damage to certain plastics (e.g. polycarbonate and plexiglass) in the load items being processed</li> </ul>	<ul style="list-style-type: none"> <li>- De-foaming agents should be used in exceptional cases only; for instance, when absolutely essential for the process.</li> <li>- The wash cabinet and accessories should be cleaned periodically without load items and without de-foaming agent using the Organic programme.</li> <li>- Contact Miele for advice.</li> </ul>
Soiling	
Problem	Measures
<p>The following substances can damage elastomers (hoses and seals) and plastics inside the machine:</p> <ul style="list-style-type: none"> <li>- Oils, waxes, aromatic and unsaturated hydrocarbons</li> <li>- Emollients</li> <li>- Cosmetics, hygiene and skincare products such as creams (analytical applications, filling)</li> </ul>	<ul style="list-style-type: none"> <li>- Depending on usage, wipe the lower door seal on the machine periodically with a lint-free cloth or sponge. Clean the wash cabinet and accessories without load items using the Organic program.</li> <li>- Process the load using the Oil programme programme (where this is available) or use a special programme that dispenses cleaning agents containing tensides.</li> </ul>
<p>The following substances can lead to heavy build-up of foam during washing and rinsing:</p> <ul style="list-style-type: none"> <li>- Some disinfection agents, dishwashing cleaning agents, etc.</li> <li>- Reagents for analysis, e.g. for microtiter plates</li> <li>- Cosmetics, hygiene and skincare products such as shampoos and creams (analytical applications, filling)</li> <li>- Active foaming agents such as surfactants</li> </ul>	<ul style="list-style-type: none"> <li>- Thoroughly rinse load items in water beforehand.</li> <li>- Select a cleaning programme with at least one short pre-rinse in cold or hot water.</li> <li>- Depending on the application, use de-foaming agents that do not contain silicone oils.</li> </ul>

## Chemical processes and technology

<b>Soiling</b>	
<b>Problem</b>	<b>Measures</b>
<p>The following substances can cause corrosion to stainless steel in the wash cabinet and the accessories:</p> <ul style="list-style-type: none"> <li>- Hydrochloric acid</li> <li>- Other substances containing chlorides such as sodium chloride, etc.</li> <li>- Concentrated sulphuric acid</li> <li>- Chromic acid</li> <li>- Iron particles and shavings</li> </ul>	<ul style="list-style-type: none"> <li>- Thoroughly rinse load items in water beforehand.</li> <li>- Put the drip-dry load items into the mobile units, baskets, modules and inserts and start a programme as soon as possible after placing in the wash cabinet.</li> </ul>
<b>Reaction between process chemicals and soiling</b>	
<b>Problem</b>	<b>Measures</b>
<p>Natural oils and fats can be emulsified with alkaline process chemicals. This can lead to a heavy build-up of foam.</p>	<ul style="list-style-type: none"> <li>- Use the Oil programme.</li> <li>- This special programme dispenses emulsifiers (pH neutral) in the pre-rinse.</li> <li>- Depending on the application, use de-foaming agents that do not contain silicone oils.</li> </ul>
<p>Stains containing high protein levels, such as blood, can cause a heavy build-up of foam when processed with alkaline process chemicals.</p>	<ul style="list-style-type: none"> <li>- Select a cleaning programme with at least one short pre-wash in cold water.</li> </ul>
<p>Non-precious metals, such as aluminium, magnesium and zinc, can release hydrogen when processed with very acidic or alkaline process chemicals (oxyhydrogen reaction).</p>	<ul style="list-style-type: none"> <li>- Please observe the process chemical manufacturer's instructions.</li> </ul>

## Adding and dispensing chemical agents

---

⚠ Unsuitable process chemicals pose a health risk.  
Using unsuitable process chemicals will generally cause an unsatisfactory reprocessing result and can pose a health risk or cause damage to property.  
Only use process chemicals designed specifically for use in this machine and follow the manufacturer's instructions on their use. Please carefully observe any instructions relating to non-toxic residues.

⚠ Process chemicals pose a health risk.  
Some process chemicals may be corrosive and irritant. Observe the relevant safety regulations and safety data sheets issued by the process chemical manufacturers when handling process chemicals.  
Take all protective measures required by the process chemical manufacturer, e.g. wear protective goggles and protective gloves.

Contact Miele for information about suitable process chemicals.

Highly viscous (thick) process chemicals can affect the dispenser monitoring and lead to inaccurate data. In this instance, please contact the Miele Customer Service Department for advice.

### Dispensing systems

The machine is equipped with a number of internal dispensing systems for chemical agents:

- Neutralisation agent  
This is dispensed using a siphon.
- Liquid detergent  
This is dispensed via a siphon.

An additional internal dispensing system can be fitted retrospectively by Miele Service if required.

### Labelling of the siphons

Liquid process chemicals from external containers are dispensed by siphons. Colour coding the siphons can be helpful for correct dispensing.

Miele uses and recommends the following:

- Blue: for cleaning agent
- Red: for neutralising agent
- Green: for chemical disinfection agents or an additional second cleaning agent
- White: for acidic process chemical
- Yellow: for free choice



### Neutralising agent

Neutralising agent (pH setting: acidic) neutralises any residues of alkaline cleaning agents on the surface of the load.

Neutralising agent is dispensed automatically in the Interim rinse phase after the main wash (see Programme charts). The reservoir must be filled and the dispensing system vented for this to occur.

In the Inorganic programme neutralising agent is dispensed additionally for an acidic pre-wash.

### Replenishing neutralising agent

- Open the drawer in the side unit.
- Remove the neutralising agent container (red marking) and place it on the open cabinet door or on a surface which is robust and easy to clean.
- Take the lid off the canister and remove the suction lance. Place the suction lance on the open wash cabinet door.
- Replace the empty container with a full one.

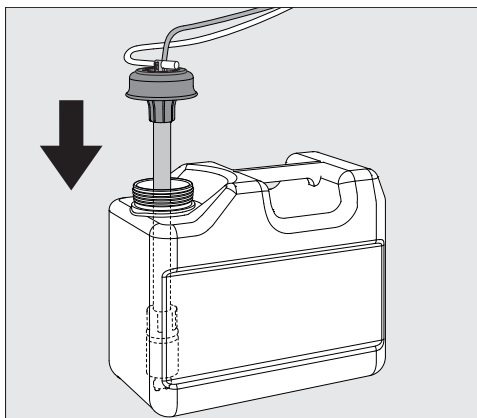

- Push the suction lance into the opening of the container and secure the lid. Observe the colour coding.
- Feed the suction lance into the container until it reaches the bottom.
- Wipe up any spilled process chemical thoroughly.
- Place the container back in the drawer in the side cabinet.
- Close the drawer. Ensure that the dispensing tubes and cables are not kinked or trapped.
- The dispensing system must then be vented (see “Settings /DOS venting”).

## Adding and dispensing chemical agents

---

### Checking consumption

Check consumption regularly by checking the fill levels in the supply containers and replace containers in good time to avoid the dispensing system being sucked completely dry.

### Refill indicator

When the fill level is low in the DOS 3 supply container for neutralising agent you are reminded to refill it.



- Confirm the message shown with *OK* and
- Refill the neutralising agent as described.

If it has run out, the machine will be locked for further use. It will be ready for use again when the supply container has been replaced.

### Dispensing neutralising agent

For adjusting the dispensing concentration, see “Further settings/Dispensing systems”.

### Cleaning agent

⚠ Risk of damage due to unsuitable cleaning agents.  
Using unsuitable cleaning agents, such as a cleaning agent for a domestic dishwasher, will mean that the reprocessing result is not as expected.  
Only use cleaning agents that are suitable for washer-disinfectors.

The cleaning machine is only designed for use with liquid cleaning agents. Liquid cleaning agent is dispensed from an external container via a suction lance.

For environmental reasons it is important to always consider the following factors when selecting a cleaning agent:

- How alkaline does the cleaning agent need to be for the cleaning application involved?
- Are protein-removing enzymes required and is the programme sequence suitable for this?
- Are tensides required for proper dispersal and emulsification?
- Is a cleaning agent containing active chlorine required or can a detergent without active chlorine be used?

⚠ Cleaning agents containing chlorine can damage the plastics and elastomers inside the machine.  
If the use of cleaning agents containing chlorine is required, a maximum temperature of 75 °C is recommended in the “Detergent dosage” programme blocks (see programme overview).  
Cleaning agents containing chlorine must not be used in machines supplied (ex works) with special oil-resistant elastomers for oil and grease applications.

For cleaning specific types of soiling, and for information on the optimum cleaning agents and additives to use for liquid dispensing, please contact the Miele Customer Service Department.

### Replenishing liquid cleaning agent

- Open the drawer in the side unit.
- Remove the liquid cleaning agent container (blue marking) and place it on the open cabinet door or on a surface which is robust and easy to clean.
- Take the lid off the canister and remove the suction lance. Place the suction lance on the open wash cabinet door.
- Replace the empty container with a full one.

## Adding and dispensing chemical agents

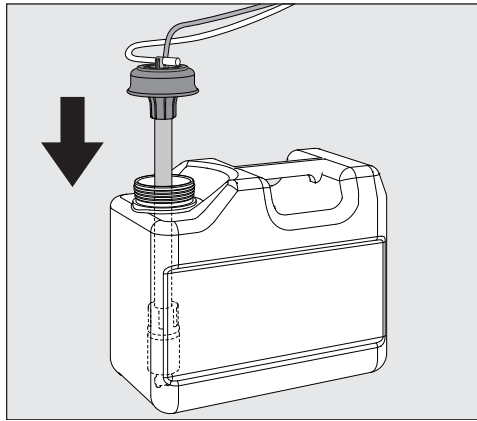

- Push the suction lance into the opening of the container and secure the lid. Observe the colour coding.
- Feed the suction lance into the container until it reaches the bottom.
- Wipe up any spilled process chemical thoroughly.
- Place the container back in the drawer in the side cabinet.
- Close the drawer. Ensure that the dispensing tubes and cables are not kinked or trapped.
- The dispensing system must then be vented (see “Settings ▸/DOS venting”).

### Checking consumption

Check consumption regularly by checking the fill levels in the supply containers and replace containers in good time to avoid the dispensing system being sucked completely dry.

### Refill indicator

When the fill level is low in the DOS 1 supply container for liquid cleaning agent you are reminded to replenish it.

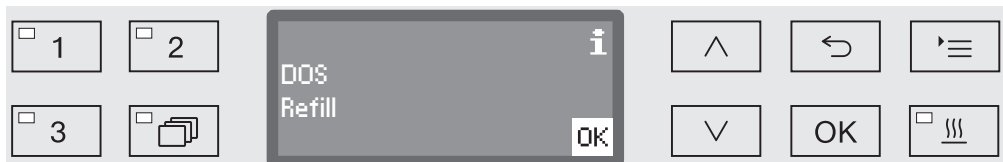

- Confirm the message shown with *OK* and
- replenish the liquid cleaning agent as described.



If the liquid cleaning agent has run out, the machine will be locked for further use.  
It will be ready for use again when the supply container has been replaced.

### Dispensing liquid detergent

For adjusting the dispensing concentration, see “Further settings/Dispensing systems”.

## Selecting a programme

### Programme selection buttons

- Select a programme using programme selection buttons ,  or .

### Programme list

- Press the  button and
- use the  $\wedge$  and  $\vee$  arrow buttons to highlight a programme and confirm your selection with *OK*.

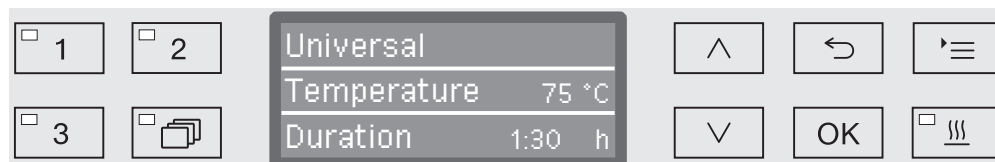



The LED in the button selected lights up and the relevant programme appears in the display. The LED in the *Start/Stop* button also starts to flash.

Another programme can be selected at any time before a programme has started. Once it has started, programme selection is locked.

The different programmes and their uses are described in “Programme chart” at the end of these operating instructions.

Always select the programme depending on the type of load and degree and type of soiling, or on infection prevention issues.

## Starting a programme

- Close the door.  
When the door is closed, the LED in the  button will light up.
- Press the *Start/Stop* button.  
The LED in the *Start/Stop* button will light up constantly and the LED in the  button will go out.

### Starting a programme using delay start

The start of a programme can be delayed (to benefit from economy rates of electricity, for example, or to clean the wash cabinet before it is used the next day). Starting from the programmed time, a delay start time between 1 minute and 24 hours can be selected in one-minute increments (see “Settings /Time of day”).

Delay start must be switched on (see “Settings /Delay start”).

If soiling is left to dry on the load for longer, the reprocessing result can be adversely affected. There is also a risk of corrosion for stainless steel items.

## Operation

Setting the start time

- Select a programme.
- Press the *OK* button before starting the programme.

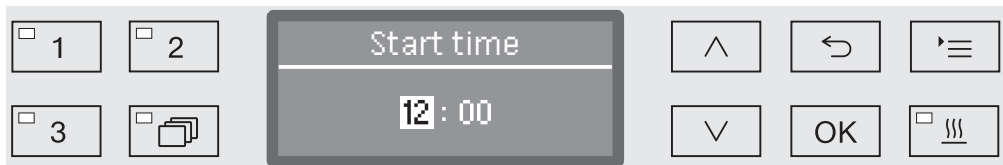

- Use the arrow buttons  $\wedge$  (higher) and  $\vee$  (lower) to set the hours, and confirm your selection with the *OK* button.

When the *OK* button is pressed, the display jumps automatically to the next input position. You cannot go back to the previous entry. If a mistake is made, the process must be cancelled using the  $\leftarrow$  button and repeated.

- Set the minutes using the arrow buttons  $\wedge$  (higher) and  $\vee$  (lower), and save your entry with *OK*.

The start time is now saved and can be changed as described at any time up to activation of delay start.

Activating delay start

- Delay start is activated with the *Start/Stop* button.

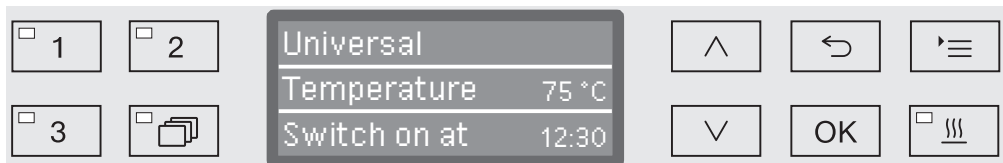

The selected programme with the set start time is then shown on the display. If automatic deactivation has been selected (see “Further settings/Switch off after”), the machine will switch itself off after the set time until the programme start time is reached.

Deactivating delay start



- Press the  $\leftarrow$  button or switch the machine off using the  $\text{⏻}$  button.

## Drying

The additional “Drying” function accelerates the drying process at the end of the programme.

When the drying function is activated and the door is closed, the drying system feeds heated and HEPA-filtered air into the wash cabinet for active drying of the load. The heated air is discharged through the steam condenser and can be cooled down if necessary (see “Further settings/Air cooling”).

The drying function can be pre-selected for all programmes with a drying phase or can be retrospectively switched on or off every time a programme is selected (see “Settings  / Drying”).

Drying is activated or deactivated prior to programme start by pressing the  button. The LED in the  button indicates whether the additional function is on or off. The drying time of the programme can also be changed.

When the drying function is activated, the programme runs longer.

## Activating and deactivating drying

- Select a programme.
- Press the  button before the programme start.



If the drying time (Drying time) is set as changeable (Time changeable?) in the programme settings, the drying time set can be altered. Otherwise, the drying time set cannot be changed.

## If drying is deactivated

If the drying function has been previously deactivated, it can be activated by pressing a button.



If the time is set as changeable, the preset drying time for this programme is shown in minutes (min) in the display and the possible setting range is displayed in the bottom line.

- Alter the drying duration using the arrow buttons  (higher) and  (lower), and save the setting with *OK*. Drying is now activated.

## Operation

---

If drying is activated

If the drying function has been activated, you can choose either to deactivate the drying function, activate automatic door opening or reset the drying time as described above.

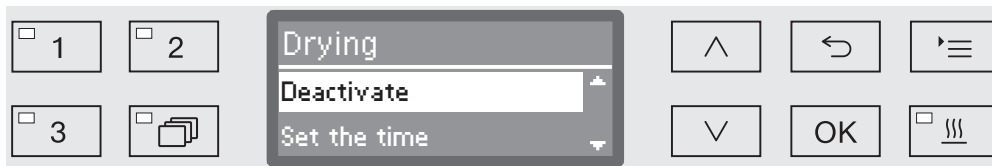

- Deactivate

Drying is deactivated.

- Set the time (only if the time is set as changeable)

You can alter the drying duration with this option.

- Automatic door opening

Activates or deactivates automatic door opening at the end of the programme.

■ Select an option using the arrow buttons  $\wedge$  and  $\vee$  and confirm this with *OK*.



## Programme sequence indicator

After the programme has started, the programme sequence can be followed on the three-line display.

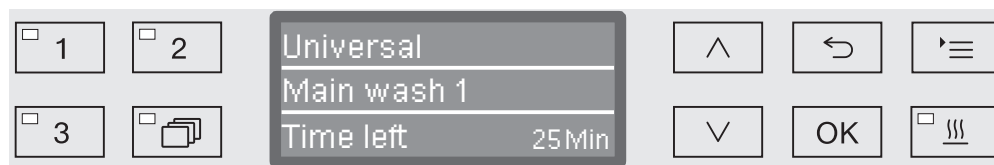

### Top line

- Programme name.

### Middle line

The following parameters can be checked using the  $\wedge$  and  $\vee$  arrow buttons:

- Current programme block, e.g. Main wash 1,
- Actual or required temperature (depending on the display set, see “Further settings/Display: Temperature”),
- $A_0$  value,
- Conductivity (only with conductivity meter).
- Cycle number,

### Bottom line

- Time left (in hours; under an hour, in minutes).

## At the end of the programme

A programme is usually finished when the following parameters and messages are shown in the display:

### Top line

- Programme name.

### Middle line

Continuously alternating between:

- Parameter met/not met,
- $A_0$  value,
- Conductivity in final wash block (only with conductivity meter).
- Cycle number,

### Bottom line

- Programme finished.

In addition, the LED in the *Start/Stop* button goes out and the LED in the  $\odot$  button begins to flash. In the factory default state, an acoustic tone also sounds for approx. 10 seconds (see “Settings/Volume”).

## Interrupting a programme

The factory default setting prevents interruption of programmes while they are running. If required, this function can be activated by Miele Service.

A programme which is already running should only be interrupted if strictly necessary, e.g. if the wash load is moving about significantly.

 Be careful when opening the door.  
The load could be hot. Danger of scalding, burning, and chemical burns.

- Press the  button.

You are asked if you really wish to open the door.

If the temperature in the wash cabinet is above 60 °C at this moment, it is first necessary to acknowledge the following message:



- Confirm the message with *OK*.

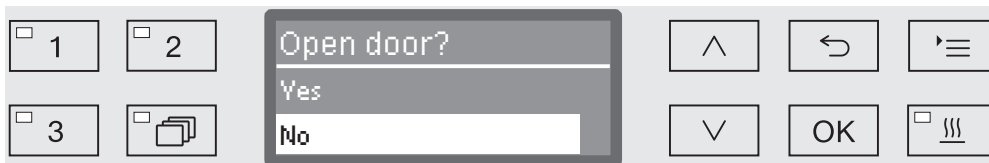

- Select *Yes* using the  $\wedge$  and  $\vee$  arrow buttons.
- By pressing the *OK* button the programme is interrupted.

Selecting *Yes* interrupts the programme and the door opens. The display shows the following message:

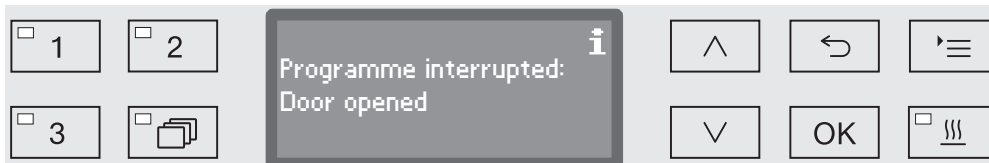

- Rearrange the items so that they are stable and close the door.

The programme continues from the point at which the interruption occurred. Every programme interruption is recorded in the cycle report.

If no button is pressed for several seconds, or if the process is cancelled using the  button, the display will revert to the programme sequence display. The programme is not interrupted.

## labelling="Section-Header">Cancelling a programme

⚠ If a programme is cancelled, the items in the washer-disinfector must be reprocessed again.

⚠ Be careful when opening the door. The load could be hot. Danger of scalding, burning, and chemical burns.

### Programme cancelled due to a fault

The programme stops and an error message appears on the display. Take appropriate steps to resolve the fault, depending on its cause (see “Problem solving guide”).

### Cancelling a programme manually

A programme which is already running should only be cancelled if strictly necessary, e.g. if the load is moving about significantly.

- Press and hold the *Start/Stop* button until the display changes to the following view:



- Select Yes using the ^ and v arrow buttons.
- By pressing the OK button the programme is cancelled. Entry of a PIN code may also be required (see “Further settings/Code”).

If no button is pressed for several seconds, or if the process is cancelled using the ↶ button, the display will revert to the programme sequence display.

### Restarting the programme

- Start the programme again or select a new programme.

## System messages

After the cleaning machine is switched on or a programme sequence is completed, a series of system messages may be shown on the display. These indicate e.g. low fill levels in the containers or required maintenance.

### Changing the filter

Several hours before reaching the maximum permitted operation hours, you will be prompted to change the air filters.

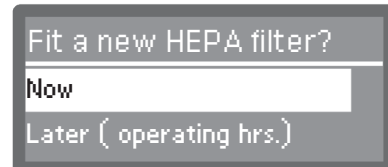
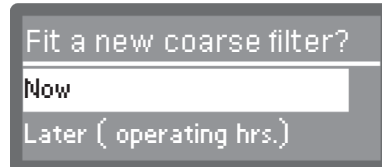

- Confirm the message with *OK* and change the filter according to the instructions in the “Maintenance” section.

### Cleaning the filter combination

The filters in the wash cabinet must be checked daily and cleaned regularly, see “Maintenance/Cleaning the filters in the wash cabinet”.

A counter in the controls can be activated to remind you of the required cleaning at regular intervals.

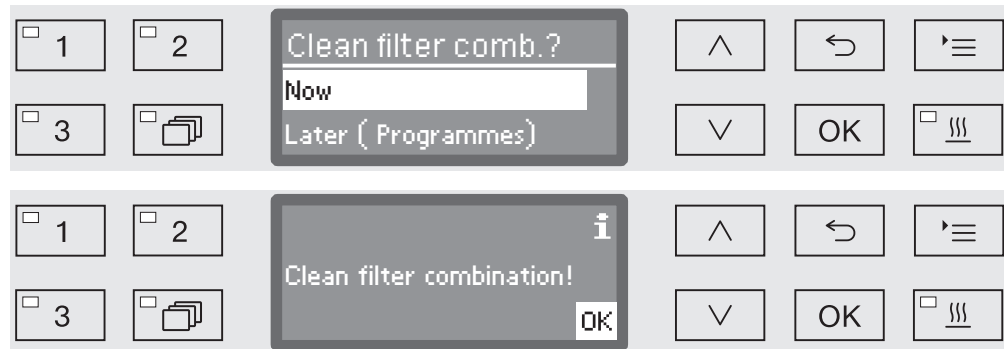

- Follow the instructions in the “Maintenance” section for cleaning the filters.

### Low fill levels

When the fill level is low in one of the containers, for example for process chemicals or the salt container, you are prompted to refill the container.

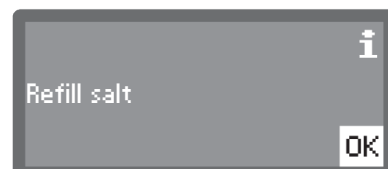

- Acknowledge the messages with *OK* and refill the relevant containers. To do this, follow the instructions in the sections “Filling process chemicals and dispensing” and “Water softener”.

### **Spray pressure and spray arm monitoring**

The machine has a sensor for monitoring spray pressure in order, for example, to detect pressure fluctuations due to misloading or foam in the water circulation system. Spray pressure monitoring is set at the factory to active in the “Cleaning” and “Final rinse” wash blocks.

The spray pressure monitoring result is documented together with process documentation.

Spray arm speed can also be monitored, e.g. for detection of blockages due to misloading or foam in the water circulation system. Spray arm speed monitoring can be activated or deactivated via the programmable settings.

Miele Service can make further settings for spray pressure and spray arm monitoring.

The structure of the Settings  menu is shown below. The menu incorporates all relevant functions to support daily routine tasks.

In the structure overview all options which can be permanently selected have boxes  beside them. Factory settings are indicated by a tick . You will find an explanation of how to change settings after the overview.

- Settings 
- ▶ Delay start
  - ▶ No
  - ▶ Yes
- ▶ Drying
  - ▶ No
  - ▶ Yes 
    - ▶ Automatic door opening
      - ▶ No
      - ▶ Programme end
- ▶ DOS venting
  - ▶ DOS\_
- ▶ Volume
  - ▶ Keypad tone
  - ▶ Buzzer tones
    - ▶ Programme end
    - ▶ Warning

## Delay start

This setting must be activated for delay start to be available for use.

- Open the menu as follows:

☰ button

▶ Settings 

▶ Delay start



- No

Delay start is deactivated.

- Yes

Delay start is activated and can be used for all programmes.

- Select an option using the ^ and v arrow buttons.
- Press *OK* to save the setting.

## Drying

The drying function can be preset or deactivated for all programmes with a drying phase (see Programme charts).

The additional “Drying” function accelerates the drying process at the end of the programme.

When the drying function is activated and the door is closed, the drying system feeds heated and HEPA-filtered air into the wash cabinet for active drying of the load. The heated air is discharged through the steam condenser and can be cooled down if necessary (see “Further settings/Air cooling”).

- Open the menu as follows:

☰ button

▶ Settings 

▶ Drying



- No

The drying function is automatically deactivated for all programmes.

- Yes

The drying function is activated for all programmes. The programme duration is lengthened if the drying function is activated.

- Select an option using the ^ and v arrow buttons.
- Press OK to save the setting.



If the Yes option was selected, Automatic door opening can be activated for all programmes. This opens the door at the end of the programme, allowing any heat remaining in the wash cabinet to dissipate faster.

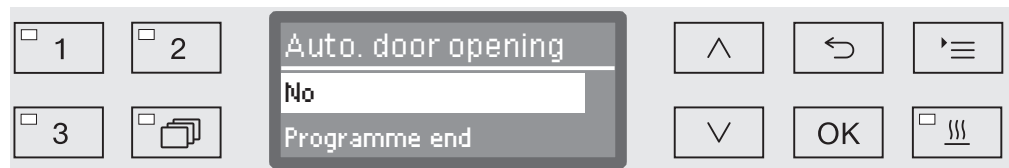

- No

The door remains closed at the end of the programme.

- Programme end

As soon as the temperature in the wash cabinet has dropped below 60 °C, the Comfort door closing aid opens the door slightly. Before the door is opened, an appropriate message is shown on the display and a signal tone sounds if the buzzer has been activated.

- Select an option using the ^ and v arrow buttons.
- Press OK to save the setting.

## DOS venting

The dispensing system for liquid chemical agents can only dispense reliably if the system has been purged of air.

The DOS system must only be vented:

- if the dispensing system is being used for the first time,
- if the liquid cleaning agent container has been replaced,
- if the dispensing system has been sucked completely dry.

Before venting, ensure that the liquid chemical agent container is sufficiently full and the siphons are securely screwed to the containers. Only one DOS system can be vented at a time.

■ Open the menu as follows:

☰ button

▶ Settings 

▶ DOS venting

▶ DOS... (name of dispensing system)

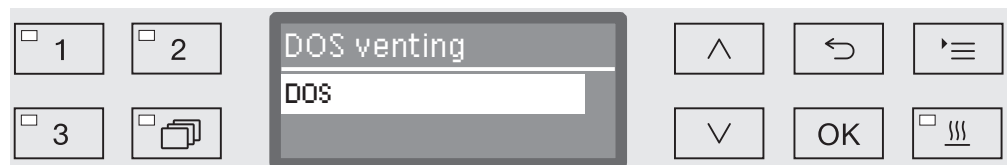

Automatic venting will start when the dispensing system is selected. Once started, the automatic venting process can no longer be cancelled.

- Select a dispensing system using the ^ and v arrow buttons.
- Press OK to start the venting process.

Automatic venting is successfully completed when the following message appears in the display:

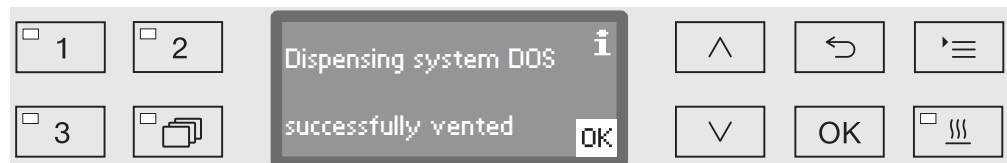

## Language



The language set will be used in the display.

- Open the menu as follows:

☰ button

▶ Settings 

▶ Language 

The flag symbol  after the Settings  and Language  menu options acts as a guide if a language which you do not understand has already been set.

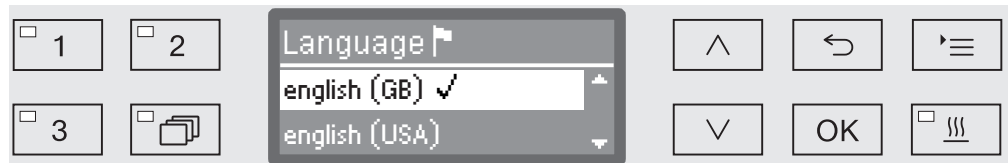

A list of all the available languages will be displayed. The language currently selected is marked with a tick ✓.

The factory default language is set as German.

- Use the ^ and v arrow buttons to select the language you want.
- Press OK to save the setting.

The display will change immediately to the language selected.

## Time of day

The time of day is required for process documentation, delay start, the machine log book and the display. The date format and the current time of day have to be set.

There is no automatic adjustment between summer and winter time (daylight savings).  
You need to make this adjustment yourself as necessary.

### Selecting the time of day format

To set the format for the time of day in the display:

- Open the menu as follows:

☰ button

- ▶ Settings 
- ▶ Time of day
- ▶ Clock display

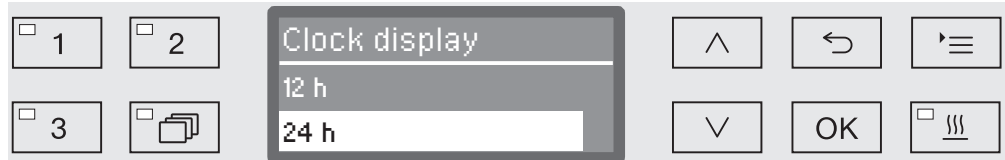

- 12 h

Time of day in 12 hour format (am/pm).

- 24 h

Time of day in 24 hour format.

- Use the  $\wedge$  and  $\vee$  arrow buttons to select the date format you want.
- Press *OK* to save the setting.

## Set the time of day

To set the format for the time of day:

- Open the menu as follows:

☰ button

- ▶ Settings 
- ▶ Time of day
- ▶ Set

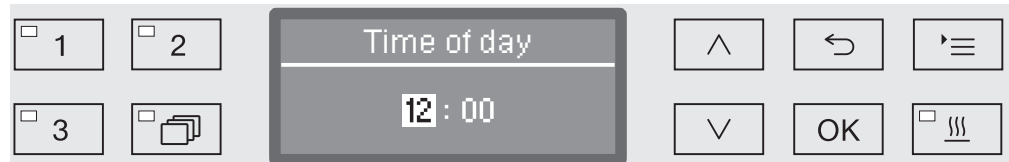

- Use the arrow buttons  $\wedge$  (higher)  $\vee$  (lower) to set the hours and confirm your entry with the *OK* button.

When the *OK* button is pressed, the display jumps automatically to the next input position. You cannot go back to the previous entry. If a mistake is made, the process must be cancelled using the  $\leftarrow$  button and repeated.

- Use the arrow buttons  $\wedge$  (higher) and  $\vee$  (lower) to set the minutes and press the *OK* button to save the time of day.

The time of day will be saved when the *OK* button is pressed for the last time.

## Display

If necessary, the machine may be placed in standby mode during breaks in operation.

- An option to display the time of day must be selected for this purpose.
- Additionally, automatic shutdown must be activated and a wait time set in “Further settings/Switch off after”.

Once the set wait time has elapsed, the machine is in standby mode. During standby, the machine remains switched on and the time is shown on the display. Pressing any button reactivates the machine.

■ Open the menu as follows:

☰ button

- ▶ Settings 
- ▶ Time of day
- ▶ Display

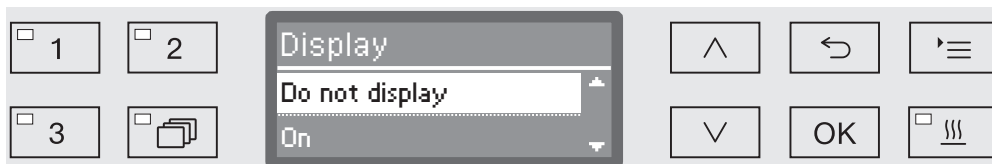

- On

Once the set wait time has elapsed, the machine is permanently in standby, and the time appears on the display.

- On for 60 seconds

Once the wait time has elapsed, the machine can be reactivated for use for a period of 60 seconds, during which the time appears on the display. After 60 seconds, the machine switches itself off.

- Do not display

Once the set wait time has elapsed, the machine switches off, and no time appears on the display.

- Select an option using the ^ and v arrow buttons.
- Press OK to save the setting.

## Volume

A buzzer which is integrated into the control panel can give an acoustic signal in the following situations:

- When buttons are pressed (keypad tone)
- At the end of the programme
- System messages (information)

■ Open the menu as follows:

☰ button

▶ Settings 

▶ Volume

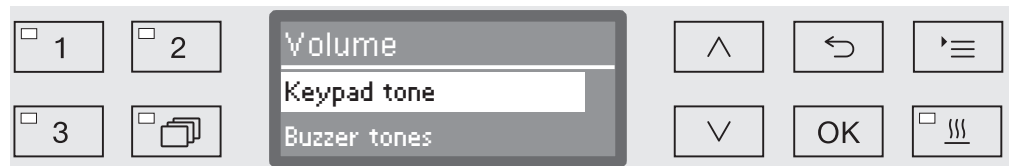

- Buzzer tones

Setting the buzzer volume for programme end and system messages (information)

- Keypad tone

Setting the buzzer volume for keypad tone.

■ Select an option using the  $\wedge$  and  $\vee$  arrow buttons.

■ Confirm your selection with *OK*.

When Keypad tone has been selected you can adjust the volume immediately. When Buzzer tones has been selected you must first select which tone, Warning or Programme end, you would like to adjust the volume for.

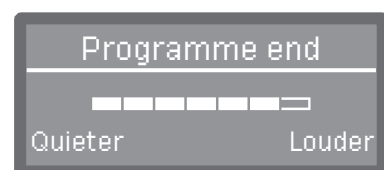
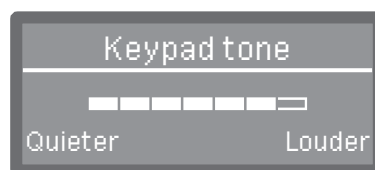

The volume level is represented by a bar chart. On the lowest setting the buzzer tone is switched off.

- Use the arrow buttons  $\wedge$  (Louder) and  $\vee$  (Quieter) to set the volume.
- Press *OK* to save the setting.

## Further settings

The Further settings menu incorporates all administrative processes and settings.

The Further settings menu can only be accessed by using a code. If you do not have the code, contact a user with appropriate access rights or cancel the process using the ↩ button.

In the structure overview all options which can be permanently selected have boxes  beside them. Factory settings are indicated by a tick . You will find an explanation of how to change settings after the overview.

### Further settings

- ▶ Code
  - ▶ Cancel programme
    - ▶ Code required
    - ▶ Code not required
  - ▶ Change code
- ▶ Date
  - ▶ Date format
    - ▶ DD:MM:YY
    - ▶ MM:DD:YY
  - ▶ Set
- ▶ Log book
  - ▶ Consumption: Water
  - ▶ Consumpt.: Clean. agent
  - ▶ Consumpt.: Rinsing agent
  - ▶ Consumption: Neut. agent
  - ▶ ...
  - ▶ Operating hours
  - ▶ Programme cycle counter
  - ▶ Service interval
- ▶ Report
  - ▶ Short
  - ▶ Long
- ▶ Temperature unit
  - ▶ °C
  - ▶ °F
- ▶ Programme settings
  - ▶ Change programme
    - ▶ ...
  - ▶ Reset programme
    - ▶ ...
- ▶ Air cooling
  - ▶ Yes
  - ▶ No
- ▶ Release programme
  - ▶ All
  - ▶ Selection
    - ▶ ...
- ▶ Move programme
  - 1 Universal
  - 2 Standard
  - 3 Intensive
- ▶ Dispensing system
  - ▶ DOS\_
    - ▶ Active
    - ▶ Inactive
  - ▶ DOS venting
  - ▶ Concentration
  - ▶ Change name
- ▶ Test programme
  - ▶ No
  - ▶ Laboratory
  - ▶ Validation
- ▶ Filter maintenance
  - ▶ Coarse filter/HEPA filter
    - ▶ Reset (Yes/No)
  - ▶ Filter combination
    - ▶ Reset (Yes/No)
    - ▶ Interval ↕ 10



- ▶ Interface
  - ▶ Ethernet
    - ▶ Module status
    - ▶ DHCP
  - ▶ RS232
    - ▶ Print reports
    - ▶ Language 
    - ▶ Mode
    - ▶ Baud rate: 9600
    - ▶ Parity: None
    - ▶ Reset (Yes/No)
- ▶ Water hardness ⇄ 19
- ▶ Display view
  - ▶ Actual temperature
  - ▶ Required temperature
- ▶ Display
  - ▶ Contrast
  - ▶ Brightness
- ▶ Switch off after
  - ▶ Yes
  - ▶ No
- ▶ Factory default
  - ▶ Reset
    - ▶ Programme settings only
    - ▶ All settings
    - ▶ No
- ▶ Software version
  - ▶ EB ID XXXXX
  - ▶ EGL ID XXXXX
  - ▶ EZL ID XXXXX
  - ▶ EFU ID XXXXX
  - ▶ LNG ID XXXXX

## Further settings

### Code

The Further settings menu incorporates relevant functions and system settings which require an enhanced knowledge of machine reprocessing. Access to the menu can therefore be protected by a four digit code.

It is not possible to block individual options or the inputting of multiple codes at the same time.



 If a code is lost, a new code must be issued by Miele Service.

### Enter code

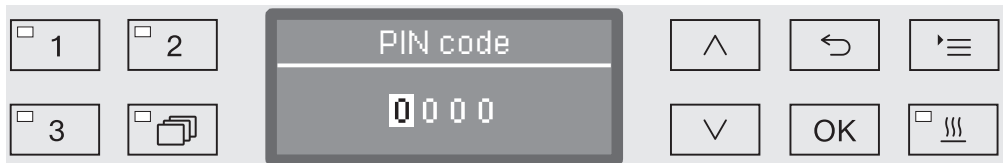
If access to the Further settings menu is blocked, you will be prompted to enter the code when it is selected.



If you do not have the code, contact a user with appropriate access rights or cancel the process using the  button.

- Use the arrow buttons  (higher) and  (lower) to enter the relevant digits.
- Confirm each digit individually with the *OK* button.

When the *OK* button is pressed, the display jumps automatically to the next input position. You cannot go back to the previous entry. If a mistake is made, the process must be cancelled using the  button and repeated. Entered digits are replaced by a \* symbol.

If all digits are entered correctly the menu will be released.

If an incorrect entry is made, an error message will appear.



- Confirm the message with *OK*.

Access remains blocked and the display reverts to the menu selection.

### To block cancellation of a programme

A programme which is already running should only be cancelled if strictly necessary, e.g. if the wash load is moving about significantly. Access to the option of cancelling a programme can be blocked using the code.

- Open the menu as follows:

☰ button

- ▶ Further settings
  - ▶ Code
    - ▶ Cancel programme



- Code required

A programme can only be cancelled by entering the code.

- Code not required

All users can cancel running programmes at any time.

- Select an option using the ^ and v arrow buttons.
- Press *OK* to save the setting.

## Further settings

### Change code

The PIN code consists of a four digit number and is set by the user. Each digit can be programmed freely between 0 and 9.

⚠ When a new PIN code is entered, the old PIN code is overwritten and is permanently deleted. Therefore it cannot be reinstated.

If a PIN code is lost, a new code must be issued by the Miele Customer Service Department.

- Open the menu as follows:

☰ button

▶ Further settings

▶ Code

▶ Change code

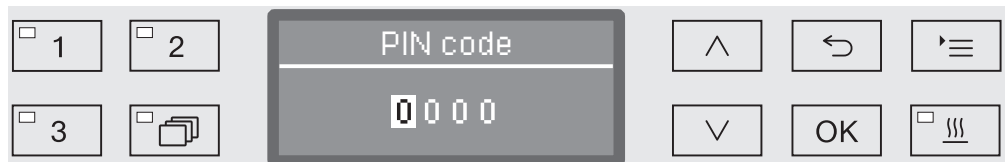

- Use the arrow buttons  $\wedge$  (higher) and  $\vee$  (lower) to enter the relevant digits.
- Confirm each digit individually with the *OK* button.

When the *OK* button is pressed, the display jumps automatically to the next input position. You cannot go back to the previous entry. If a mistake is made, the process must be cancelled using the  $\curvearrowright$  button and repeated. Entered digits are replaced by a \* symbol.

The code is saved to memory once you have confirmed the last digit.

### Date

The date is required e.g. for process documentation. The date format and the current date have to be set.

#### Select the date format

The selected date format appears in the display and in the process documentation.

- Open the menu as follows:

☰ button

▶ Further settings

▶ Date

▶ Date format



- DD = Day
- MM = Month
- YY = Year

- Use the ^ and v arrow buttons to select the date format you want.
- Press OK to save the setting.

## Further settings

---

### Set the date

The current date will be set in the selected date format.

- Open the menu as follows:

☰ button

▶ Further settings

▶ Date

▶ Set

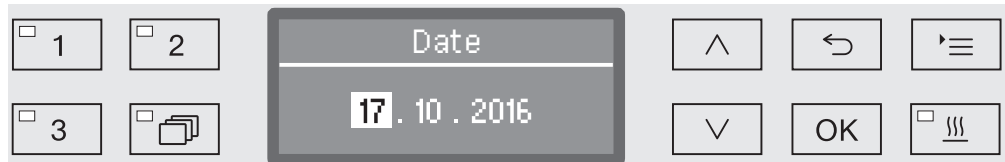

- Use the arrow buttons  $\wedge$  (higher) and  $\vee$  (lower) and confirm your entry using the *OK* button.

When the *OK* button is pressed, the display jumps automatically to the next input position. You cannot go back to the previous entry. If a mistake is made, the process must be cancelled using the  $\leftarrow$  button and repeated.

- Use the arrow buttons  $\wedge$  (higher) and  $\vee$  (lower) to set the month/day and confirm your entry using the *OK* button.
- Use the arrow buttons  $\wedge$  (higher) and  $\vee$  (lower) to set the year and press the *OK* button to save the date.

The date will be saved when the *OK* button is pressed for the last time.

### Log book

The entire life cycle of the machine, including consumption data for water and chemical agents, as well as operating hours and programme cycles are recorded in the log book.

Miele Service can also use the log to calculate a recommendation for service intervals.

- Open the menu as follows:

☰ button

▶ Further settings

▶ Log book

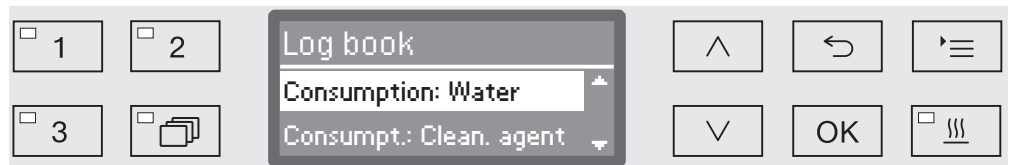

- Consumption: Water  
Display the total amount of water used in litres (l).
- Consumpt.: Clean. agent  
Display the total amount of liquid cleaning agent used in litres (l).
- Consumpt.: Rinsing agent  
Display the total amount of rinsing agent used in litres (l).
- Consumption: Neut. agent  
Display the total amount of neutralising agent used in litres (l).
- Operating hours  
Display the total number of operating hours.
- Programme cycle counter  
Total of all completed programme sequences. There is no breakdown of individual programmes. Cancelled programmes are not included.
- Service interval  
Date of the next service (entered by the Miele Customer Service Department).

- Select an option using the ^ and v arrow buttons and confirm your choice with OK.

Values in the machine log book cannot be altered.

- Press the ↶ button to exit the menu.

## Further settings

---

### Report

You can choose between two different report formats of process reports for the purpose of archiving.

More information on selecting these can be found in “Process documentation”.

### Temperature unit

During a programme the temperature display is refreshed every 2 to 5 seconds depending on the programme stage. The temperature can be displayed in degrees Celsius (°C) or Fahrenheit (°F).

The temperature unit is set at the factory to °C.

When the temperature unit is changed to °F, the temperature displayed is automatically recalculated.

- Open the menu as follows:

☰ button

▶ Further settings

▶ Temperature unit

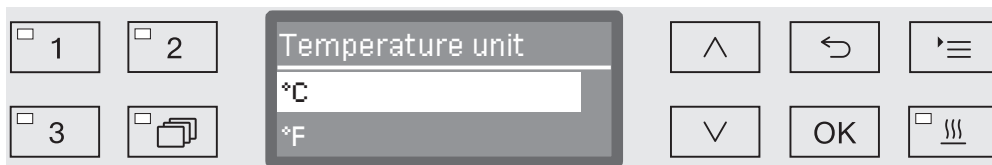

- °C

Display temperature in degrees Celsius.

- °F

Display temperature in degrees Fahrenheit.

- Select an option using the  $\wedge$  and  $\vee$  arrow buttons.
- Press *OK* to save the setting.

### Programme settings

You can use this menu to customise the current programme to suit technical requirements and the load or to reset all programmes to the factory default settings.

Additional specialist knowledge is required to alter programme settings and this should therefore be undertaken only by experienced users or by the Miele Customer Service Department.

More information can be found in “Programme settings”.



### Air cooling

During the drying phase, the hot exhaust air from the wash cabinet is released into the room via the steam condenser. Depending on the size of the room, this can heat up the room to a greater or lesser degree.

To reduce this effect, the heated air can be cooled down during the drying phase using a fine spray in the steam condenser.

Cooling in the steam condenser will increase water consumption.

- Open the menu as follows:

☰ button

▶ Further settings

▶ Air cooling

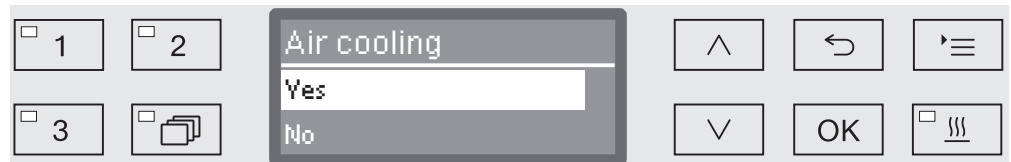

- Yes

Hot air is cooled using the steam condenser.

- No

Hot air is released uncooled into the room.

- Select an option using the ^ and v arrow buttons.
- Press *OK* to save the setting.

## Further settings

### Release programme

It is possible to block access to individual programmes. Blocked programmes are not available for selection, so for example it can be ensured that only validated programmes are used.

- Open the menu as follows:

'≡ button

- ▶ Further settings
- ▶ Release programme

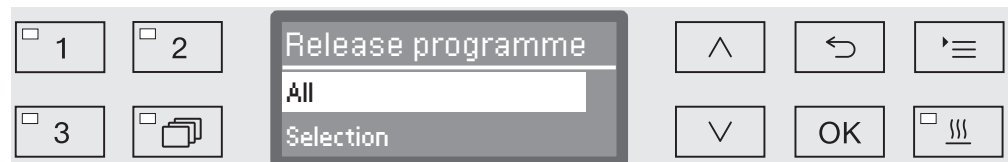

- All

All programmes are released for use.

- Selection

A selection of programmes are available for use.

- Select an option using the ^ and v arrow buttons and confirm your selection with *OK*.

The Selection option displays a list of all programmes.

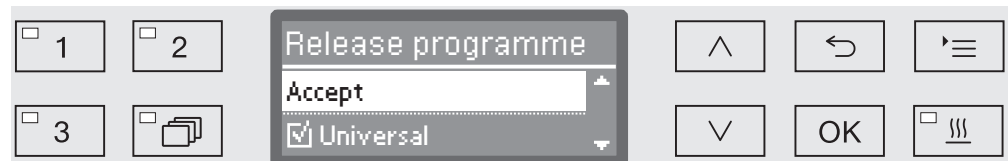

Programmes are selected by multiple choice. A box is shown next to all programmes in the list. If a programme is released, there is a tick  in the box. An empty box indicates a blocked programme.

- Programmes can be released or blocked using the arrow buttons ^ and v and by confirming with *OK*.
- To save the selection select the *Accept* option at the end of the list and confirm with *OK*.

### Moving a programme: allocating programme selection buttons

You can sort the programme selection list to suit your requirements and therefore also allocate the programme selection buttons 1, 2 and 3.

- Open the menu as follows:

☰ button

▶ Further settings

▶ Move programme



All released programmes are shown in the programme list (see “Further settings/Programme release”). A programme's position in the programme list is decisive for allocating the programme selection buttons. Programmes are numbered from 1 - n. The first three programmes in the list are allocated to the programme selection buttons; for example:

- 1. Universal on the programme selection button 1
- 2. Standard on the programme selection button 2
- 3. Intensive on the programme selection button 3
- 4. Inorganic
- 5. Organic
- etc.

- Use the ^ and v arrow buttons to select the programme you would like to move.
- Confirm your selection with *OK*.

Now you can move this programme within the list.

- Use the ^ and v arrow buttons to move the programme to the position you want.
- Press *OK* to save the programme to the selected position.

The programme which was previously saved to this position and all subsequent programmes are moved down by one position.

The process can be repeated as often as you wish.

- Press the ↶ button to exit the menu.

## Further settings

---

### Dispensing systems

Up to two chemical agents can be dispensed in each wash block. Using the following menu you can activate and vent the dispensing system, change the name if necessary and set the dispensing concentration for all programmes.

#### Activating dispensing systems

Individual dispensing systems can be activated or deactivated for all programmes as follows.

- Open the menu as follows:

☰ button

▶ Further settings

▶ Dispensing system

▶ DOS... (name of dispensing system)



- Active

The selected dispensing system is activated. Dispensing will only occur in the appropriate wash blocks (see Programme charts).

- Inactive

The selected dispensing system is deactivated for all programmes.

- Select an option using the ^ and v arrow buttons.
- Press OK to save the setting.

### DOS venting

The dispensing system for liquid chemical agents can only dispense reliably if the system has been purged of air.

The DOS system must only be vented:

- if the dispensing system is being used for the first time,
- if the liquid cleaning agent container has been replaced,
- if the dispensing system has been sucked completely dry.

Before venting, ensure that the liquid chemical agent container is sufficiently full and the siphons are securely screwed to the containers. Only one DOS system can be vented at a time.

■ Open the menu as follows:

☰ button

- ▶ Further settings
  - ▶ Dispensing system
    - ▶ DOS... (name of dispensing system)
      - ▶ DOS venting

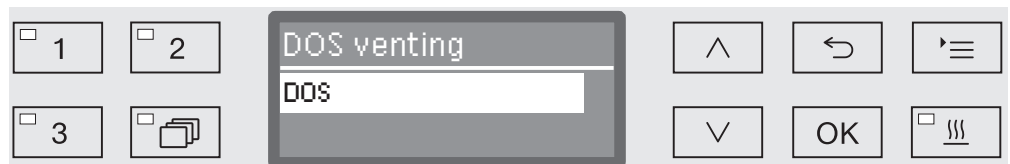

Automatic venting will start when the dispensing system is selected. Once started, the automatic venting process can no longer be cancelled.

- Select a dispensing system using the  $\wedge$  and  $\vee$  arrow buttons.
- Press *OK* to start the venting process.

Automatic venting is successfully completed when the following message appears in the display:

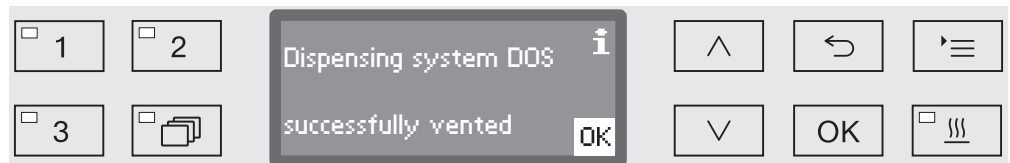

## Further settings

### Setting the dispensing concentration for liquid agents

Dispensing concentration for liquid chemical agents, e.g. in the case of a change of manufacturer, can be adjusted for all programmes at once.

Dispensing concentration must be set in accordance with the manufacturer's instructions or with the required processing result.

Consumption of liquid agents is recorded in the log book (see "Further settings/Log book").

Changing programme parameters on a validated machine will necessitate a renewed performance validation.

- Open the menu as follows:

☰ button

- ▶ Further settings
  - ▶ Dispensing system
    - ▶ DOS\_
      - ▶ Concentration

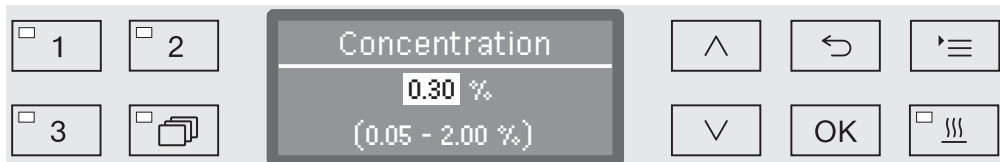

Dispensing concentration can be adjusted in increments of 0.01. The possible range is shown in the bottom line of the display.

- Set the concentration using the arrow buttons  $\wedge$  (higher) and  $\vee$  (lower).
- Press *OK* to save the setting.

### Renaming a dispensing system

If required the names of the dispensing systems “DOS1”, “DOS2” etc. can be extended to include additional information e.g. “DOS1 cleaning agent”. The name “DOS” and the accompanying number cannot be changed.

Use this option to document all changes to factory settings in case of a subsequent Service call requirement.

If the option





- Change name

has been selected, the display changes to the following view:



The current name is shown on the second line of the display. This can be changed using the options shown in the bottom line. The top line shows which option has been selected from the bottom line.

Names may consist of up to 15 characters including spaces. The following options are available:

- Letters from A to Z, each new word will start with a capital letter.
- Numbers from 0 to 9.
- Space \_.
- Use the  symbol to delete the last position.
- The name is saved when the OK symbol in the display is selected. The display will then revert to the initial menu.
- The  symbol in the display or the  button end the process without saving the name change. The display reverts to the initial menu.
- Use the arrow buttons  (right) and  (left) to move the cursor to the option you require.
- Confirm each entry with *OK*.

### Test programme

Various programmes are available for monitoring cleaning performance in routine testing.

See “Maintenance” for more information on these programmes.

## Further settings

---

### Filter maintenance

#### Changing the air filter

The air filter in the drying unit must be replaced regularly with a new one. For more information on changing the filter, see “Maintenance/Changing the filter”.

#### Cleaning the filters in the wash cabinet

The filters in the wash cabinet must be checked daily and cleaned regularly, see “Maintenance/Cleaning the filters in the wash cabinet”.

A counter in the controls can be activated to remind you of the required cleaning at regular intervals.

#### Activating and setting the interval

- Open the menu as follows:

☰ button

▶ Further settings

▶ Filter maintenance

▶ Filter combination

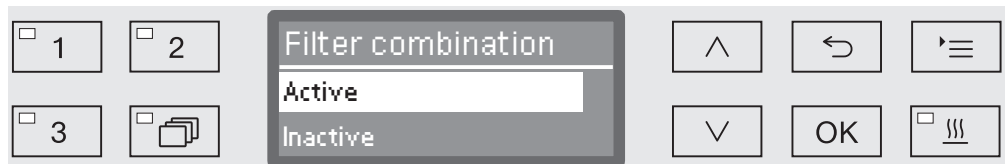

- Active

The cleaning interval is activated.

The Active selection allows you to reset the counter or set the cleaning interval.

- Inactive

The cleaning interval is deactivated.

- Select an option using the ^ and v arrow buttons and confirm your choice with OK.



### Resetting the counter

The counter for the cleaning interval may be reset only after cleaning has been completed.

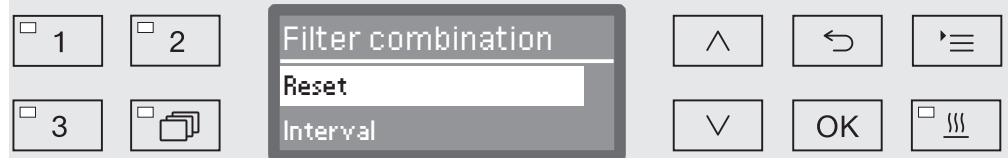

- Reset  
The counter is reset.
- Interval
- Select an option using the  $\wedge$  and  $\vee$  arrow buttons and confirm your choice with *OK*.

### Setting the interval

The interval depends on the number of programme sequences and must be set on the basis of usage and the expected number of particles/solids in the soiling.

Example:

For weekly cleaning with 2 programme sequences per day and 5 working days in the week, this yields an interval of 10 ( $2 \times 5 = 10$ ). With a higher incidence of particles, a shorter interval should be selected in order to clean the filters several times weekly.

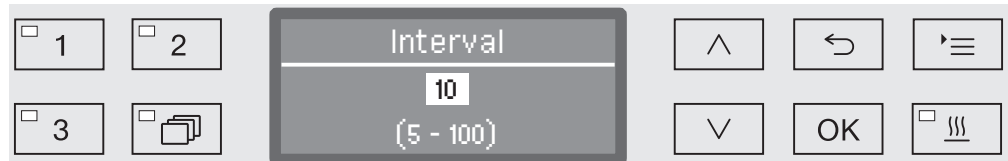

The setting value is entered in increments of 5. The possible range is shown in the bottom line of the display.

- Use the arrow buttons  $\wedge$  (higher) and  $\vee$  (lower) to set the interval.
- Press *OK* to save the setting.

## Further settings

---

### Interface

With Miele cleaning machines, cleaning processes can be documented. To enable this, these cleaning machines are equipped with a module slot on the back to take a Miele communication module. The communication module is available from Miele. and comes with its own operating instructions.

 Unauthorised access poses a risk.  
Settings in the machine (e.g. the wash block temperature or the dosage of process chemicals) may be changed as a result of unauthorised access via the network.  
The machine should be operated on a separate network segment that is physically disconnected from other network segments or access to the network should be restricted using a firewall or a router configured to provide protection against unauthorised access.  
Use strong passwords to protect access to the network.  
Limit access to the network to persons requiring access in the course of their work.

Only terminal devices (PCs, printers, etc.) which comply with EN/IEC 62368 (AS/NZS 62368) should be used.

Contact Miele for more information about communication modules, software and suitable printers.

Ethernet

The XKM 3000 L Med communication module enables the establishment of an Ethernet interface for digital archiving of process data via external software.

The module can be connected to a WiFi network via an existing wireless access point.

RS-232

A XKM RS232 10 Med communication module is required for direct connection to a report printer.

The XKM RS232 10 Med module can also be used for connection to a terminal or terminal emulator. The data is transmitted in ASCII code.

### Configuring the interface

⚠ Only specialists are permitted to configure the interface.

- Open the menu as follows:

☰ button

▶ Further settings

▶ Interface



- Ethernet

Configuration of an Ethernet interface

- RS232

Configuration of a serial RS-232 interface

- Select the type of interface and confirm your selection with **OK**.

Then the parameters for the interface must be configured.

### Ethernet

- Module status

Connection status displayed (Active/Inactive).

- Address status

List of interface parameters, e.g. IP address, Subnet mask etc.

- DHCP

The Ethernet interface can either be implemented via a Dynamic Host Configuration Protocol (DHCP) or by setting the following parameters:

- IP address
- Subnet mask
- Standard gateway
- DNS server automatic
- DNS server 1
- DNS server 2
- Port type
- Port

## Further settings

---

### RS-232

- Print reports  
Subsequent selection of cycle reports (see “Process documentation”).
- Language   
Any one of the following languages can be set for the RS-232 interface:  
German, English (GB), French, Italian, Spanish, Portuguese, Swedish or Russian.
- Mode
  - Terminal  
Connection to a terminal or terminal emulator.  
Cyrillic characters are not available as ASCII code. When Russian is selected as the language, the information appears in English (GB).
  - Printer  
Connection to log printer.
- Baud rate  
Transfer speed of the interface.
  - 2400, 9600, 19200, 38400, 57600, 115200.
- Parity  
Ensuring data transmission. The parity of the sender and receiver must match.
  - None, Even, Odd.
- Reset  
The interface configuration is reset to the factory defaults.

The following parameters are pre-configured:

Baud rate	9600
Bit	8
Parity	None
Stop bits	1

### Water hardness

You can use this menu to set the water softener to the water hardness of the mains supply.

For more information see “Water softener”.

### Display: Temperature

The wash cabinet temperature can be viewed during a programme. Either the current actual temperature or the required temperature which has been preset for the current wash block is displayed.

- Open the menu as follows:

☰ button

▶ Further settings

▶ Display view

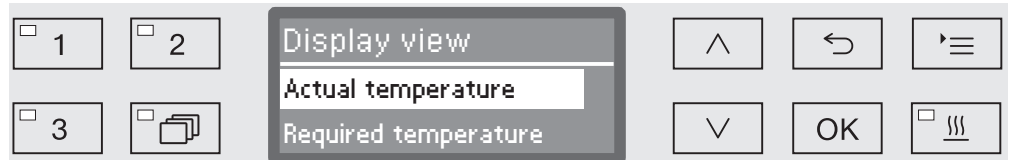

- Actual temperature

Display the current actual temperature in the wash cabinet.

- Required temperature

Display the required temperature which has been preset for the current wash block. If a temperature has not been set, a dotted line --- is shown.

During a programme both settings are displayed together as Temperature. There is no breakdown of actual and required temperature.

- Select an option using the ^ and v arrow buttons.
- Press *OK* to save the setting.

## Further settings

---

### Display brightness and contrast

You can use this menu to adjust the brightness and contrast of the display.

- Open the menu as follows:

☰ button

▶ Further settings

▶ Display



- Contrast

Set the contrast.

- Brightness

Set the brightness.

- Select an option using the  $\wedge$  and  $\vee$  arrow buttons.
- Confirm your selection with *OK*.

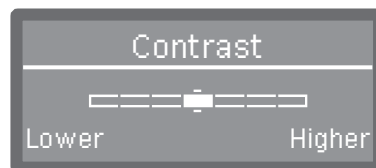

Contrast and brightness are shown as a bar chart in the display.

- Use the arrow buttons  $\wedge$  (Higher/Brighter) and  $\vee$  (Lower/Darker) to set the brightness and contrast you want.
- Press *OK* to save the setting.

### Switch off after

If the machine has not been used for a specific time period, it can be set to standby or switched off automatically.

### Ready for operation

When it is ready for use, the machine remains switched on and the time is shown on the display. Pressing any button reactivates the machine.

- To activate standby, the Auto-off function must be enabled under Further settings/Switch off after and a standby time set.
- An option to display the time of day must be selected in Settings /Time of day/Display.

Once the set standby time elapses, the machine is activated for use.

### Auto-off function

To save energy, the Auto-off function can be activated. If the machine has not been used for a specific duration, it switches itself off automatically.

- To activate the Auto-off function, it must first be enabled under Further settings/Switch off after and a standby time set.
- Then, the Do not display option must be selected under Settings /Time of day/Display.

After the standby time has elapsed, the machine switches off automatically.

- Use the  button to switch the machine on again.

## Further settings

### Switching off after activating

- Open the menu as follows:

- ≡ button
  - Further settings
    - Switch off after

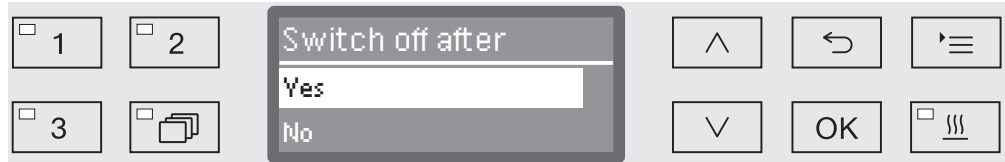

- Yes

The Auto-Off function is activated. A duration must be set after which automatic switch-off should occur.

- No

The Auto-Off function is deactivated.

- Select an option using the  $\wedge$  and  $\vee$  arrow buttons.
- Press *OK* to save the setting.

### Setting the wait time duration

If the *Yes* option is displayed, the wait time duration after which automatic switch-off should occur must be set next.



The wait time duration can be adjusted in 5 minute increments. The possible range is shown in the bottom line of the display.

- Use the  $\wedge$  (higher) and  $\vee$  (lower) arrow buttons to set the wait time duration.
- Press *OK* to save the setting.



### Factory default

All parameters which have been altered can be reset to their default settings. Control parameters and programme settings are reset separately.

- Open the menu as follows:

☰ button

- ▶ Further settings
  - ▶ Factory default
    - ▶ Reset



- No

Altered parameters are maintained.

- Programme settings only

All programme settings are reset.

Programmes saved on free memory locations remain unchanged.

- All settings

All control parameters including dispensing quantities and water hardness will be reset.

- Select an option using the ^ and v arrow buttons.
- Confirm your selection with *OK*.

The machine is restarted.

### All settings

When All settings is selected and the machine is restarted, you will be prompted to re-enter basic parameters such as the language, date, time, water hardness, etc.

- Enter the language, date, time etc.

When the last entry is made, all the parameters are saved and the factory default settings have been reset. The display changes and shows the last selected programme.

### Software version

You can use this menu to call up the software versions of individual elements, e.g. when contacting Miele Service.

For more information see “Service”.

## Adjusting programme settings

The programme settings should be adjusted to suit technical requirements and the load.

Additional specialist knowledge is required to alter programme settings and this should therefore be undertaken only by experienced users or by the Miele Customer Service Department.

Changing programme parameters on a validated machine will necessitate a renewed performance validation.

## Programme structure

Each programme is subdivided into programme blocks which run one after another. A programme consists of at least one and a maximum of eleven programme blocks. Each block can occur only once in a programme.

The so-called programme header is placed above the programme blocks and contains general programme settings. Individual wash block parameters are also globally activated or deactivated here.

### Programme header

- Spray arm monitoring

It is possible to monitor spray arm rotation in selected wash blocks.

- LFMMc max. value

The conductivity of the water in the final rinse phase is monitored using a conductivity measuring module (LFMMc).

- Change volume of water

The water intake quantity can be increased or reduced in each programme. The setting is then valid for all programme blocks including water intake.

- Drain time

If the on-site drainage system is insufficient to drain the waste water from the wash cabinet within the time allocated, the drainage time can be increased.

### Programme blocks

Wash block sequence is predefined and is the same as in the programme chart (see “Programme chart”).

- Pre-wash 1 to 3

Pre-washing removes coarse soiling and foaming agents.

- Main wash 1 and 2

Depending on wash load cleaning generally occurs at temperatures between 50 °C and 85 °C with the addition of appropriate cleaning agent.

- Interim rinse 1 to 4

In the interim rinse stages the chemical agents from the previous wash blocks are rinsed away and neutralised where necessary by the addition of neutralising agents.

- Final rinse 1 to 2

To avoid deposits on the wash load demineralised (AD) water should preferably be used if available for the final rinse.

- Drying

Adequate drying reduces residual moisture on the load.

### Opening the menu

The menu for programme settings is locked for machine users by factory default. If required, this function can be activated by the Miele Customer Service Department.

- Open the menu as follows:

☰ button

▶ Further settings

▶ Programme settings

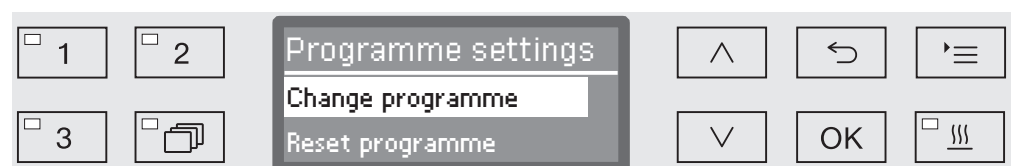

- Change programme

Programmes can be adapted to suit specific technical requirements.

- Reset programme

Reset a programme to factory default settings. Programmes newly installed by Miele Service will be deleted with this option.

## Programme settings

---

### Reset programme

Programmes can be individually reset to factory default.

 Programmes stored on a free memory location are irretrievably deleted.

...

▶ Programme settings

▶ Reset programme

All programmes are then listed in the display.

- Use the  $\wedge$  and  $\vee$  arrow buttons to select the programme and confirm your selection with *OK*.

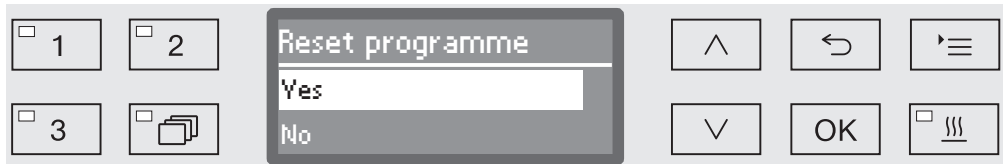

- Yes

The programme will be reset to factory default.

- No

Programme parameters will not be changed.

- Use the  $\wedge$  and  $\vee$  arrow buttons to select an option and confirm your selection with *OK*.

## Altering a programme

You can alter all parameters which are identified as changeable in the programme charts. Other settings can only be altered by Miele Service.

A programme setting is altered in two steps:

- First the wash blocks must be reallocated to the programme or the existing allocation confirmed again. Only allocated programme blocks can be parameterised.
- Then the programme parameters can be altered.

Use this option to document all changes to factory settings in case of a subsequent Service call requirement.

Changing programme parameters on a validated machine will necessitate a renewed performance validation.

- ...
- ▶ Programme settings
- ▶ Change programme



- Select the programme you want to alter.

For more information see “Allocating wash blocks”.

## Allocating wash blocks

For every programme change the wash blocks must first be allocated.



Allocation is by multiple choice. A box is shown next to all wash blocks in the display. If a wash block is allocated to the programme, there is a tick  in the box. This wash block is allocated to the programme by ticking the box or the allocation can be removed by removing the tick.

- The wash blocks can be selected or deselected using the  $\wedge$  and  $\vee$  arrow buttons and confirming with *OK*.
- To save the selection select the *Accept* option at the end of the list and confirm with *OK*.
- If you want to adopt the preset wash blocks without any changes, you can confirm the *Accept* option immediately with *OK*.

The further setting options will then follow. You can edit these in any order you want.

## Programme settings

### Spray arm monitoring

The cleaning result depends on the wash water reaching all surfaces and cavities of the wash load. To do this the wash water is distributed throughout the wash cabinet by the rotation of the machine, basket and mobile unit spray arms.

It is possible to monitor the rotation speed of the spray arms during a programme.

The rotation speed is determined using special magnetic spray arms. The sensors of this machine cannot detect the magnetic spray arms of older basket and mobile unit models, and therefore these cannot be monitored.

If the rotation speed detected is not within a preset range, this is an indication of blockage due to loading errors or build-up of foam in the water circulation system.

The rotation speed range depends on the area of application, the programme and the mobile unit or basket used.

### Switching on spray arm monitoring

Spray arm monitoring is switched on and off globally for all wash blocks.

...

► Spray arm monitoring



- Off

Spray arm monitoring is switched off.

- Off for basket

Only the machine spray arms are monitored. The sensors for the basket and mobile unit spray arms are deactivated.

- On

All spray arms are monitored.

■ Select an option using the ^ and v arrow buttons.

■ Press OK to save the setting.

The action desired at different spray arm rotation speeds is set in each wash block.

...

- ▶ Select wash block, e.g.: Main wash 1
- ▶ Spray arm monitoring

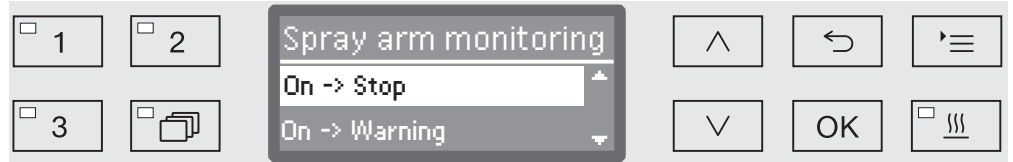

- On -> Stop

A programme in operation is interrupted if the rotation speed deviates. The interruption is shown on the display and noted in the cycle report.

- On -> Warning

The programme continues to run normally if the rotation speed deviates. Only a message appears on the display and the deviation is noted in the cycle report.

- Off

No message appears and the programme continues to run normally.

- Select an option using the  $\wedge$  and  $\vee$  arrow buttons.
- Press *OK* to save the setting.

## Programme settings

---

### Measuring conductivity

Electrical conductivity in a water based solution is a measure of the total amount of dissolved conductive substances (e.g. salts, acids, etc.).

The electrical conductivity during the final rinse phase is relevant for the processing result. Salts and deposits in the water remain on the wash load after drying.

High conductivity in this phase can limit the intended use of processed wash load items.

The conductivity of water used is affected by insufficient / varying quality at the outset, caused by e.g.,

- an empty water softener and / or demineralisation cartridge (optional accessory),
- a ruptured membrane in the reverse osmosis unit (optional accessory),
- on-site work on the water supply,
- transposed plumbing connections after maintenance work,

Possible causes for carry-over of conductive substances from previous wash blocks are e.g.:

- residual used water,
- residual initial contamination,
- residual chemical agents,
- properties of items being processed, e.g. hollow,
- type of load,
- foam.

The conductivity of the final rinse phase is the total of the conductivity of water used in water inflow and the carry-over of conductive substances from the previous wash blocks.

The machine's conductivity meter monitors the conductivity of the wash water. Non-conductive substances, e.g. non-ionic tensides are not detected by the sensor.



## Activating conductivity measuring

Conductivity measuring is activated individually for each programme. Conductivity is measured in the final rinse phase.

...

▶ LFMMc max. value

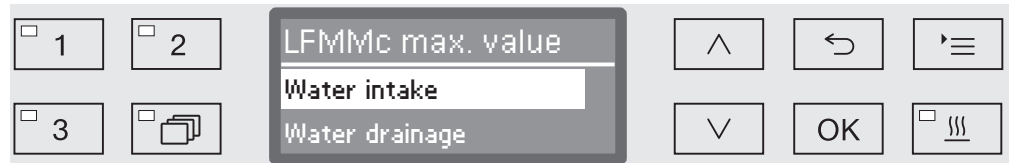

- Water intake

The electrical conductivity of the water before the beginning of the final rinse phase is measured.

- Water drainage

The electrical conductivity of the water at the end of the final rinse phase is measured.

- Select an option using the  $\wedge$  and  $\vee$  arrow buttons.
- Press *OK* to save the setting.

Following selection a maximum limit value for electrical conductivity must be set.

## Set limit value

The limit values for Water intake and Water drainage are set individually.

...

▶ LFMMc max. value

▶ Water intake or Water drainage

▶ Set

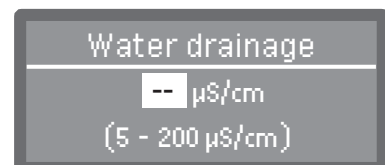
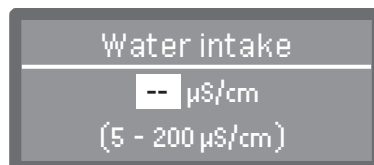

Adjustment is in increments of 1. The possible range is shown in the bottom line.

- Use the arrow buttons  $\wedge$  (higher) and  $\vee$  (lower) to set the limit value.
- Touch *OK* to save the limit value.

## Programme settings

### Repeating if limit value is exceeded

If the conductivity exceeds the limit value for the water intake or drainage, the measurement can be repeated.

If the limit value of the water intake is too high, the water is pumped out and the water intake is repeated. If the conductivity at the end of the rinse cycle is above the limit value for the drainage water, the entire final rinse is repeated.

If the measured value is still above the limit following the repetition, the programme is cancelled with a error message. The error message is shown in the display and also recorded in the process documentation.

...

▶ LFMMc max. value

▶ Water intake or Water drainage

▶ Number of repeats

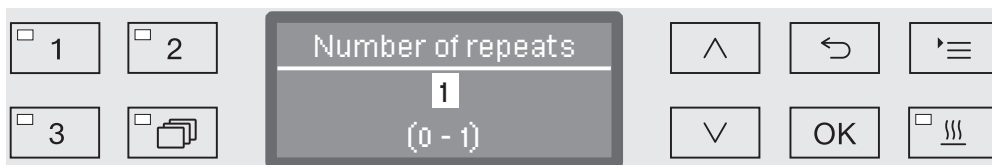

Adjustment is in increments of 1. The possible range is shown in the bottom line.

- Use the arrow buttons  $\wedge$  (higher) and  $\vee$  (lower) to set the number of repetitions.
- Press *OK* to save the setting.

### Calibrating the conductivity meter

The conductivity meter must be recalibrated by Miele Service at regular intervals, e.g. during servicing. Sometimes calibration may also be necessary outside the service cycle.

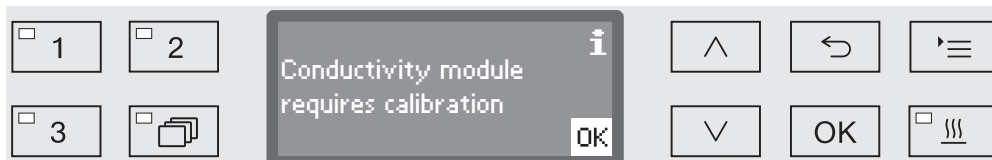

- If this message appears, contact the Miele Service Department.

## Activating the conductivity sensor

The conductivity is measured during the final rinse phase (see programme charts).

- ...
- ▶ Final rinse 1 or Final rinse 2
- ▶ Monitor LFMMc

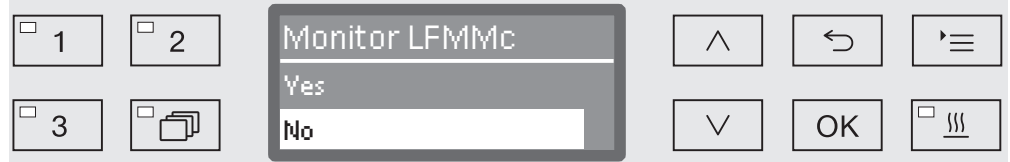

- Yes

The conductivity is being measured.

- No

The conductivity sensor is deactivated.

- Select an option using the ^ and v arrow buttons.
- Press OK to save the setting.

## Change water quantity

Increasing the water level is advisable if a large amount of water clings to items due to the structure of the wash load or if a heavy build-up of foam might occur due to the type of soiling (e.g. blood) and the chemical agents used. The additional amount of water required depends on the type of basket or mobile unit used, the type of soiling and the load.

If a lightly soiled load is being reprocessed which does not hold much water, the amount of water can be reset to the factory default amount to save water and energy.

- ...
- ▶ Change volume of water

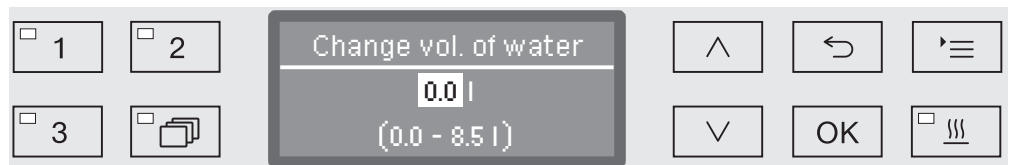

The water quantity can be increased in 0.5 l increments, or set back to the factory default amount. The possible range is shown in the bottom line. The setting "0 l" equates to the factory default setting.

- Use the arrow buttons ^ (higher) and v (lower) to alter the water quantity.
- Press OK to save the setting.

## Programme settings

### Increasing drainage time

If there is still water remaining in the wash cabinet at the end of a wash block, because e.g. the on-site drainage system is inadequate, the following error message will be displayed to enable water to be drained out of the wash cabinet within the designated time:

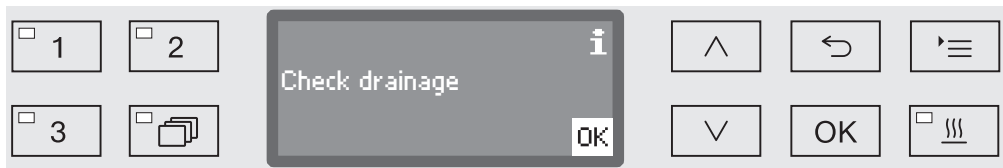

In this case the drainage time can be increased.

...  
▶ Drain time

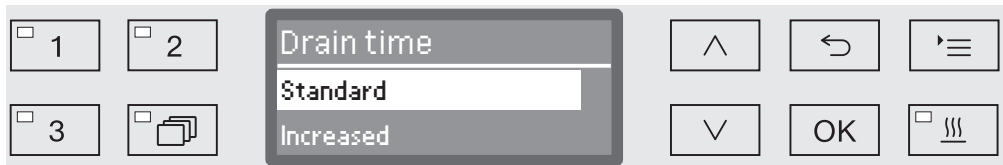

- Standard

The standard drainage time setting applies.

- Increased

Drainage time is increased by a strictly preset increment.  
Programme duration will increase with this setting.

- Select an option using the ^ and v arrow buttons.
- Press OK to save the setting.

## Setting the concentration level

Up to two chemical agents can be dispensed in each wash block. It is also possible to control the same dispensing system twice.

- ...
- ▶ Dosage 1 or Dosage 2
- ▶ Dispensing system

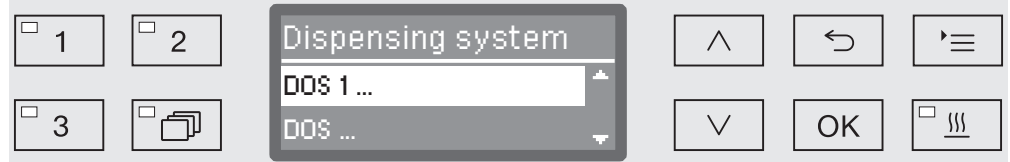

The number of dispensing systems can vary according to model and the number of connected DOS modules.

- Select an option using the  $\wedge$  and  $\vee$  arrow buttons and save your choice with *OK*.

Then you can set the dispensing concentration in % (percent).

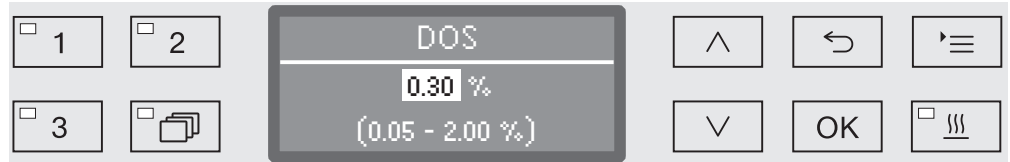

Adjustment is in 0.01% increments. The possible range is shown in the bottom line.

- Use the arrow buttons  $\wedge$  (higher) and  $\vee$  (lower) to set the dispensing concentration.
- Press *OK* to save the setting.

## Programme settings

### Set wash block temperature

The wash block temperature is reached by heating up the wash water. The temperature must be suited to the requirements of the task.

At temperatures over 55 °C, protein denaturing occurs which can cause the soiling to fix.  
Infection prevention requirements must be observed as appropriate.

...

► Wash block temperature

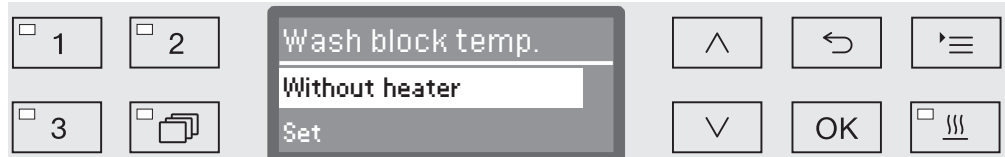

- Without heater

The wash water is not heated up. The temperature in the wash cabinet is the result of the temperature of the previous wash block and the influx of water.

- Set

Setting a wash block temperature.

- Select an option using the  $\wedge$  and  $\vee$  arrow buttons.
- Press *OK* to save the setting.

When *Set* is selected the wash block temperature must then be entered.

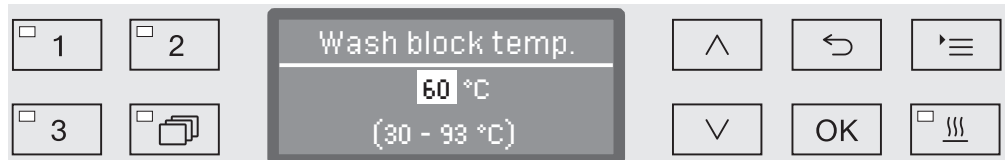

Adjustment is in increments of 1. The possible range is shown in the bottom line.

Dispensing of chemical agents occurs at a default dispensing temperature set at the factory. If chemical agents are to be dispensed in this wash block, the lowest temperature that can be set will be the dispensing temperature. It is not possible to set a lower value.

- Use the arrow buttons  $\wedge$  (higher) and  $\vee$  (lower) to set the wash block temperature.
- Press *OK* to save the setting.

### Set the holding time

The holding time is the duration in which the wash block temperature is kept constant.

...  
▶ Holding time



The duration can be set in 1 minute increments. The possible range is shown in the bottom line.

If chemical agents are to be dispensed in this wash block, the holding time will at least equal the DOS exposure time. It is not possible to set a lower value.

- Use the arrow buttons  $\wedge$  (higher) and  $\vee$  (lower) to set the holding time.
- Press *OK* to save the setting.

## Programme settings

### Drying unit

The additional “Drying” function accelerates the drying process at the end of the programme.

When the drying function is activated and the door is closed, the drying system feeds heated and HEPA-filtered air into the wash cabinet for active drying of the load. The heated air is discharged through the steam condenser and can be cooled down if necessary (see “Further settings/Air cooling”).

### Cooling down pause

A cooling down pause can be inserted between the end of the final rinse phase and starting of the drying system. During this pause, water vapour is extracted from the wash cabinet and condensed by the steam condenser. This reduces the moisture level in the wash cabinet, which promotes drying.

...

#### ► Cooling down pause

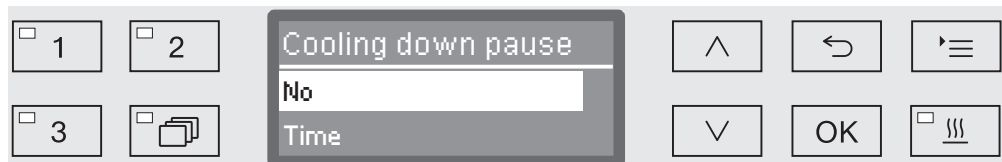

#### - No

The drying unit starts immediately after the rinse phase without a cooling down pause.

#### - Time

The cooling down pause is activated for a duration which can be set.

- Select an option using the  $\wedge$  and  $\vee$  arrow buttons and confirm your selection with *OK*.

When *Time* has been selected, the duration of the cooling down pause must then be set.

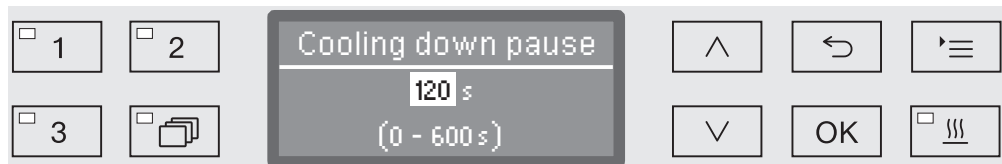

The setting value is entered in increments of 10 seconds. The possible range is shown in the bottom line of the display.

- Use the arrow buttons  $\wedge$  (higher) and  $\vee$  (lower) to set the duration of the cooling down pause.
- Press *OK* to save the setting.



Setting the temperature and time

The drying phase consists of two blocks. The temperature and duration (holding time) must be set for each block. The first block (temperature 1 and drying time 1) is not assigned in all programmes, but if necessary can be set up by the Miele Customer Service Department.

Setting temperature 1

...

▶ Temperature 1

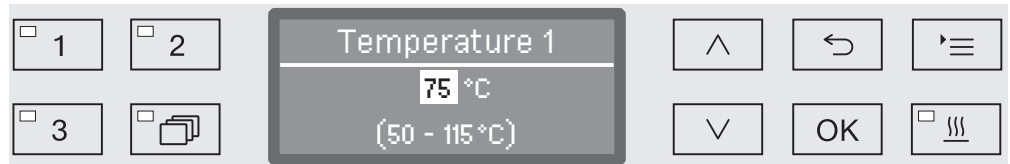

The temperature is set in 5 ° increments. The possible range is shown in the bottom line of the display.

- Use the arrow buttons  $\wedge$  (higher) and  $\vee$  (lower) to set the temperature.
- Press *OK* to save the setting.

Setting drying time 1

...

▶ Drying time 1



The holding time is set in 1 minute increments. The possible range is shown in the bottom line of the display.

- Use the arrow buttons  $\wedge$  (higher) and  $\vee$  (lower) to set the holding time.
- Press *OK* to save the setting.

Setting temperature 2

...

▶ Temperature 2

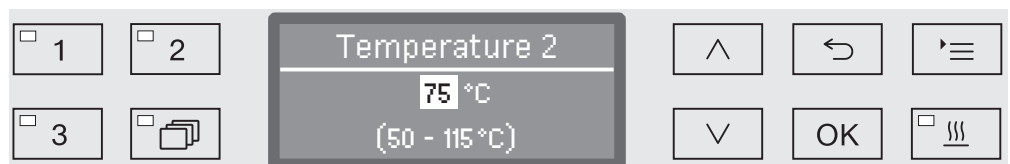

The temperature is set in 5 ° increments. The possible range is shown in the bottom line of the display.

- Use the arrow buttons  $\wedge$  (higher) and  $\vee$  (lower) to set the temperature.
- Press *OK* to save the setting.

## Programme settings

---

Setting drying  
time 2

...  
▶ Drying time 2  
▶ Set

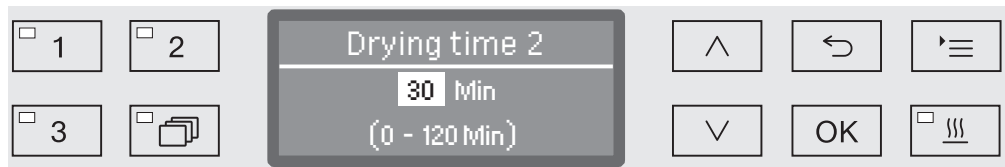

The holding time is set in 1 minute increments. The possible range is shown in the bottom line of the display.

- Use the arrow buttons  $\wedge$  (higher) and  $\vee$  (lower) to set the holding time.
- Press *OK* to save the setting.

Time changeable

If required, the drying time can be set again and saved before the start of every programme.

...  
▶ Drying time 2  
▶ Time changeable?

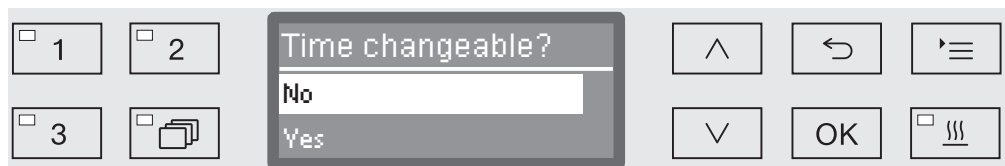

- Yes

Drying time can be set again and saved before the start of every programme.

- No

Drying duration cannot be changed.

- Select an option using the  $\wedge$  and  $\vee$  arrow buttons.
- Press *OK* to save the setting.

### Fan cooling

After drying, cooling of the wash load can be accelerated by the drying system. To do so, the drying system fan runs with the heating switched off, cooling the interior of the wash cabinet.

...

#### ► Cooling down with fan

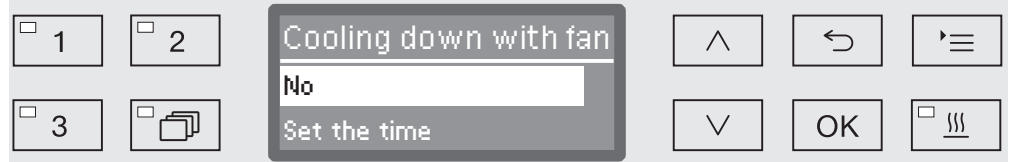

- No

The drying system fan is not switched on.

- Set the time

The drying system fan will run for a specified duration.

- Select an option using the  $\wedge$  and  $\vee$  arrow buttons and confirm your selection with *OK*.

When *Set the time* has been selected, the duration of the cooling down pause must then be set.

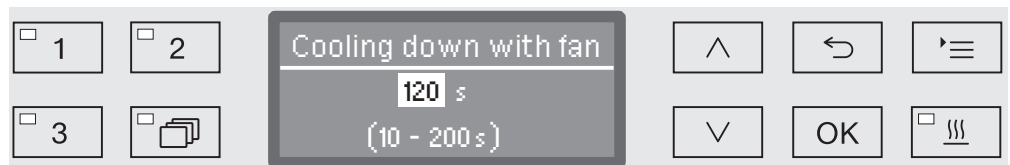

The setting value is entered in increments of 10 seconds. The possible range is shown in the bottom line of the display.

- Use the arrow buttons  $\wedge$  (higher) and  $\vee$  (lower) to set the cooling down duration.
- Press *OK* to save the setting.

### Documenting processes

Processes are documented per cycle. Required and actual values are always recorded.

During a programme sequence the following data is recorded, among other things:

- Machine model and serial number
- Date
- Programme start and programme name
- Cycle number
- Wash blocks used
- Dispensing system with dispensing temperature and target dispensing amount if necessary
- Target values for temperature and holding times
- Minimum and maximum temperatures during the holding time
- Wash pressure measuring results
- All fault messages
- End of programme
- System messages, e.g. salt refill

Further data can be incorporated into the report as required. Contact the Miele Customer Service Department for more information on this.

### Memory

Depending on scale, between 10 and max. 20 cycle reports are stored in an internal power failure safe memory within the machine. In the event of network or printer problems, for example, these can be subsequently recalled. If the memory is full, the oldest report is overwritten.

In addition, raw data from the last programme sequence is stored to create a graphical display of the process data. This data can be transformed into graphical representations using external documentation software. Transferring raw data requires an Ethernet interface. It is not possible to create graphical representations in the display or on a directly connected printer. Power failure safe storage of graphical information is not available.

### Adding cycle numbers

The Miele Customer Service Department can add subsequent cycle numbers, e.g. in the event of software updates or if the machine controls are replaced.

## Communication module for external archiving

A module slot is integrated into the back of the machine for a Miele communication module for permanent archiving of batch protocols. The module enables the installation of an Ethernet interface for documentation using documentation software or an RS-232 interface for connection to a report printer.

Please contact Miele for further information on software and suitable printers.

Only terminal devices (PCs, printers, etc.) which comply with EN/IEC 62368 (AS/NZS 62368) should be used.

The communication modules are available from Miele as an accessory and can be retrofitted at any time. The modules are supplied with their own installation instructions.

Only specialists are permitted to configure the interface. Follow the instructions in "Additional settings/Interface".

## Process documentation using external software

For digital archiving the process data is transmitted to external documentation software via an Ethernet interface. Transmission can optionally occur continuously during the process or as a single transaction at the end of the process. The settings for this are modified by Miele Service.

Information on wash pressure,  $A_0$  value, conductivity and temperature in the wash cabinet can be archived graphically if required.

Installation of an Ethernet interface requires the retrospective fitting of an XKM 3000 L Med communication module.

For connection to a WLAN network the module can be connected via a cable to an existing wireless access point.

### Problems with data transmission

If there is a network problem during a running process, e.g. due to a loose cable, a relevant fault message is displayed.

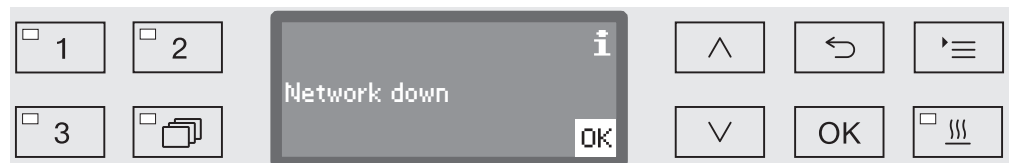

The process running will be continued without interruption and the process data will be saved in the meantime in the internal memory.

In the event of network or report software problems contact your system or network administrator.

## Process documentation

### Process documentation using a report printer

Process reports are printed via a directly connected report printer and archived on paper. Graphic representations are not included. An XKM RS232 10 Med communication module is required for direct connection.

#### Report formats

You can choose from two different report formats for paper archiving:

- In long format all recorded data is included.
- Short format includes only selected parameters.

The report format has no effect on the data stored in the washer-disinfector. All the data required for a long report is stored, so the report format can be changed for each new cycle.

- Open the menu as follows:

☰ button

▶ Further settings

▶ Report



- Short

Print in short format

- Long

Print in long format

- Select an option using the ^ and v arrow buttons.
- Press *OK* to save the setting.

## Outputting cycle reports retrospectively

Internally stored reports can be output retrospectively from the machine.

**External software** If supported, data can be retrieved directly via the documentation software using an existing network connection. It is not necessary to input entries at the machine itself.

**Report printer** The following options are available for printing reports retrospectively.

■ Open the menu as follows:

☰ button

▶ Further settings

▶ Interface

▶ RS232

▶ Print reports



- Last report

Output last cycle report

- Current work day

Output all cycle reports for the current working day

- Last working day

Output all cycle reports for the previous working day

- All

Output all saved reports.

■ Select an option using the ^ and v arrow buttons.

■ Data transmission is started by pressing the OK button.

Data transmission runs in the background so the machine can go on being used.

## Periodic checks

The machine should be serviced **every 1000 hours of operation, or at least once a year**, by the Miele Customer Service Department or a suitably qualified specialist.

Maintenance covers the following points and functional checks:

- Replacement of wear parts
- Electrical safety check compliant with national rules and regulations (e.g. VDE 0701, VDE 0702 in Germany)
- Door mechanism and door seal
- Any screw connections and connectors inside the wash cabinet
- Water inlet and drainage
- Internal and external dispensing systems
- Spray arms
- Filter combination
- Sump including drain pump and non-return valve
- All mobile units, baskets, modules and inserts
- Steam condenser
- Wash mechanism/wash pressure
- Drying unit
- Conductivity meter
- Visual inspection and functional check of components
- A thermo-electric check (optional on request)
- Seals will be tested for water tightness
- Safety testing of all relevant measuring systems
- Safety features

External documentation software and the computer network will not be tested by the Miele Customer Service Department.



## Routine checks

Before the start of each working day, the user must carry out a number of routine checks. A checklist is supplied with the machine for this purpose.

The following need to be inspected:

- All filters in the wash chamber
- The spray arms in the machine and in any mobile units, modules and baskets
- The wash chamber and the door seal
- The dispensing systems
- The mobile units, baskets, modules and inserts
- The filters in the load carriers

## Cleaning the filters in the wash cabinet

The filters in the floor of the wash chamber prevent coarse soiling from coming into contact with the circulation system. Filters can become blocked by soiling. They therefore need to be checked every day and cleaned as necessary.

 Risk of damage due to blocked waterways.  
If the filters are not inserted, dirt particles will end up in the machine water circuit. The dirt particles may block the nozzles and valves.  
Only start a programme if the filters are inserted.  
Check that the filters are positioned correctly when you reinsert them after cleaning.

In the controls, it is possible to set a cleaning interval for the filters in the wash cabinet, see “Settings /Filter maintenance”.  
The cleaning interval is not a substitute for the daily routine check of the filters in the wash cabinet!

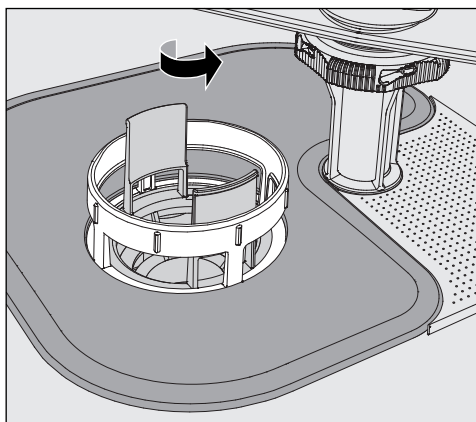

 Danger of injury from glass shards, needles, etc. retained in the filters.

## Maintenance

- Turn the microfine filter in the direction of the arrow and remove it together with the coarse filter.

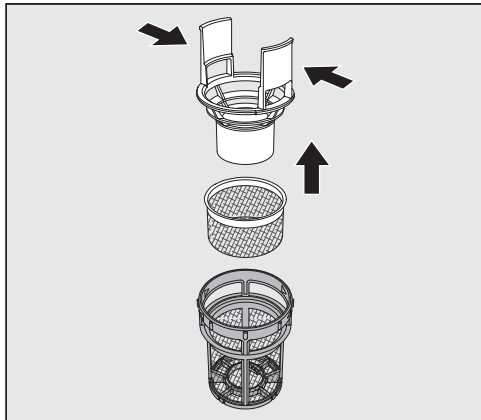

- Press the catches towards each other and pull the coarse filter upwards to remove it.
- Remove the fine filter which sits loosely between the coarse filter and the microfine filter.

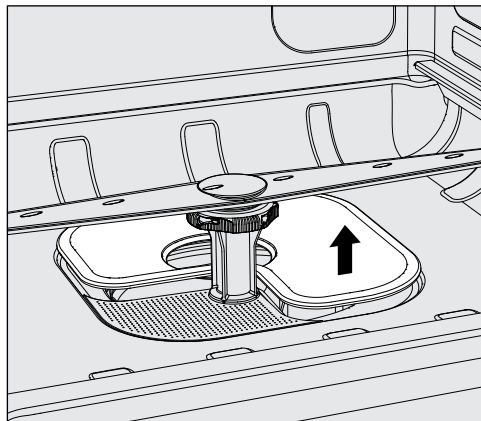

- Remove the flat filter last.
- Clean the filters.
- Re-insert the filter combination in the reverse order. Ensure ...
  - ... that the flat filter sits flat in the base of the wash cabinet.
  - ... that the coarse filter has securely clicked into place in the microfine filter.
  - ... that the microfine filter is tightly screwed in as far as it will go.

If a cleaning interval was set for the filters in the wash cabinet, this interval must be reset after cleaning; see "Settings ▾/Filter maintenance."

## Cleaning the spray arms

The spray arm nozzles can become blocked, especially if the filters are not inserted correctly in the wash chamber. This can cause coarse particles of soiling to get into the wash water circulation.

The spray arms must be visually checked daily for any soiling.

- To do this remove the mobile unit and the baskets.
- Visually check the spray arms for soiling and blocked nozzles.
- Also check that the spray arms can turn easily.

⚠ Immobile or blocked spray arms must not be used again. In this case, contact the Miele Customer Service Department.

## Cleaning the spray arms

The spray arms in the machine as well as in the mobile units and baskets must be fully dismantled for cleaning:

- Remove the mobile unit or baskets from the machine.

The machine upper spray arm is connected by a push-fit connector.

- Pull the machine upper spray arm downwards to remove it.

The machine lower spray arm and the spray arms in the mobile units and baskets are secured with bayonet fittings.

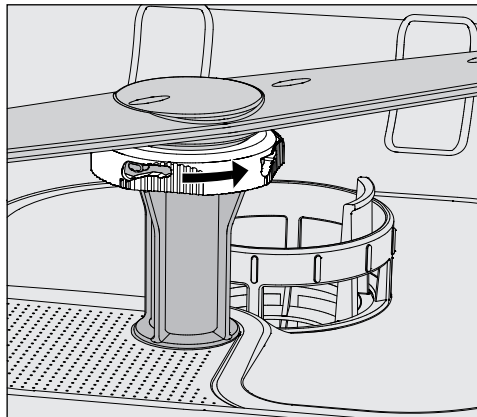

- To release the knurled bayonet fittings, turn them in the direction of the arrow as far as they will go.
- Then the spray arms can be removed by pulling them upwards or downwards.

### Mobile unit and basket spray arms with knurled nuts:

The spray arms of older types of mobile units and baskets are secured with knurled nuts. These must be unscrewed and the spray arms pulled downwards to remove them.

Metal knurled nuts have a left-hand thread.

Ceramic knurled nuts have a right-hand thread.

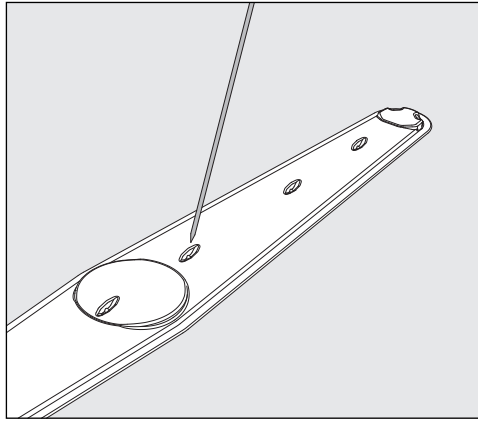

- Use a pointed object to push particles into the spray arm.
- Rinse the spray arm thoroughly under running water.

⚠ Do not allow any magnetic objects or load items to attach to the magnets on the spray arms.  
Any metallic objects on the magnets can cause a false reading of spray arm rotation.  
Remove all metal objects from the magnets.

- Check the spray arm bearings for visible signs of wear.

Visible wear on the bearings can adversely affect the long-term functioning of the spray arms.  
In this case, contact the Miele Customer Service Department.

- Replace the spray arms after cleaning.
- Make sure the spray arms can rotate easily after they have been fitted.

The spray arms and baskets each have a number e.g. 03, which is also embossed on the water supply pipes near the bayonet fittings.  
When refitting, ensure that the numbers on the spray arms correspond with the numbers on the water supply pipes.

## Cleaning the machine

⚠ Never clean the machine or near vicinity with a water hose or a pressure washer.

⚠ Do not use cleaning agents containing ammonia or thinners on stainless steel surfaces!

These agents can damage the surface material.

## Cleaning the control panel

⚠ Do not use any abrasive materials or general-purpose cleaners to clean the control panel.

These can cause considerable damage to the glass and plastic surfaces and to the onset control buttons.

- Clean the control panel with a damp cloth and a little washing-up liquid or with a non-abrasive stainless steel cleaner.
- Proprietary glass or plastic cleaning agents can also be used to clean the display.
- For surface disinfection use a listed agent recommended by the manufacturer.

## Cleaning the door and the door seal

- Wipe the door seals regularly with a damp cloth to remove any soiling.  
Seals which are no longer tight or which have suffered damage must be replaced with new ones by the Miele Customer Service Department.
- Remove any stains from the door sides and hinges.
- Regularly clean the groove in the plinth panel under the door with a damp cloth.

## Cleaning the wash chamber

The wash chamber is generally self-cleaning. However, should a build-up of deposits occur in the chamber, please contact the Miele Customer Service Department for advice.

## Cleaning the door front

- To clean the stainless steel front, use a damp cloth with a solution of washing-up liquid and hot water, or with a non-abrasive cleaning agent for use on stainless steel.

## Preventing re-soiling

- To help prevent re-soiling of stainless steel surfaces (fingerprints, etc.), a suitable stainless steel conditioner can be used after cleaning.

### Checking mobile units, baskets, modules and inserts

Mobile units, baskets, modules and inserts must be checked daily to make sure they are functioning correctly. A checklist is supplied with the cleaning machine.

The following points need to be checked:

- Are the mobile unit rollers or basket rollers in good condition, and are they securely attached to their mobile units or baskets?
- Are the water connectors present and undamaged?
- Are height-adjustable water connectors adjusted to the correct height and securely fixed?
- Are all injector nozzles, irrigation sleeves and hose adapters securely attached to mobile units, baskets and modules?
- Are all injector nozzles, irrigation sleeves and hose adapters clear so that wash water can flow through unhindered?
- Are all caps and fasteners securely attached to the irrigation sleeves?
- Are end caps present and securely positioned for all modules and injector manifolds?
- Are the caps in the water connectors of mobile units and baskets working properly?

Where applicable:

- Do the spray arms rotate freely?
- Are the spray arm nozzles free of any blockages? See "Cleaning the spray arms".
- Are the magnets integrated into the spray arms free of any metallic objects sticking to them?
- Check whether the tubular filters need to be cleaned or filter plates, e.g. in an E 478/1 need to be replaced.

### Maintenance of mobile units, baskets, modules and inserts

The machine should be serviced **every 1000 hours of operation, or at least once a year**, by the Miele Customer Service Department or a suitably qualified specialist.

## Filter change

The air filter for the internal drying unit has a limited lifespan and has to be replaced at regular intervals, e.g. when the following message appears:



## Changing the coarse filter

- Open the drawer in the side unit.

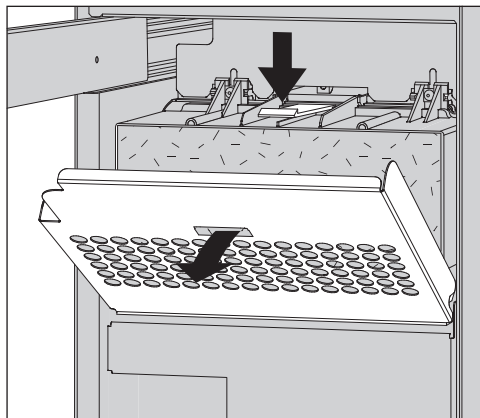

- Release the filter grille and swing it downwards to open. The grille can also be removed completely.

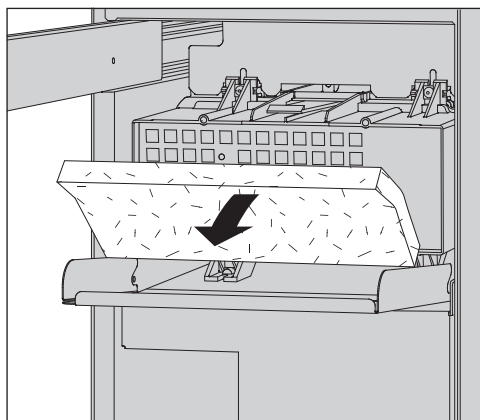

- Change the coarse filter. The soft side of the filter must be to the front.
- Replace the filter grille and close the side unit drawer.

Whenever the coarse filter is replaced the operating hours counter must be reset (see “Resetting the operating hours counter”).

## Maintenance

### Changing the HEPA filter

Replace with an **Original Miele HEPA filter classification 14** for optimum performance.

If possible, the Miele Customer Service Department should replace the HEPA filter as part of a maintenance visit. If this is not possible, you can change the filter as follows:

- Open the drawer in the side unit and remove the filter grille and the coarse filter.

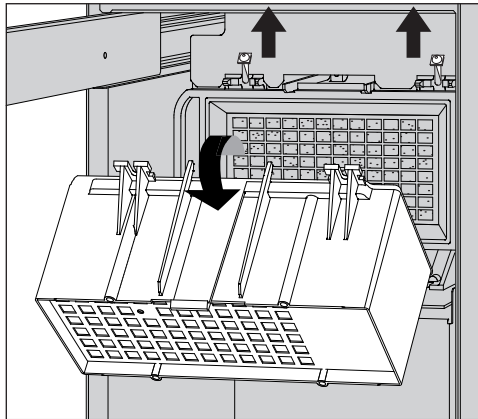

- Detach the coarse filter housing by unscrewing the fixing screws and pushing them upwards.
- Remove the coarse filter housing.

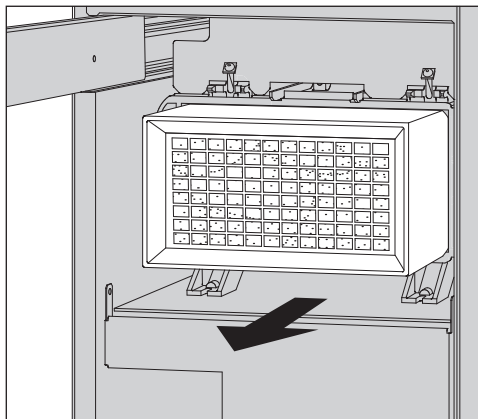

- Remove the HEPA filter from its holder and insert a new one.
- Reinsert the coarse filter housing and tighten the fixing screws.
- Reinsert the coarse filter and the filter grille and close the drawer in the side unit.

Whenever the HEPA filter is replaced, the operating hours counter must be reset (see “Resetting the operating hours counter”).



## Resetting the operating hours counter

The maximum permissible number of operating hours is pre-set in the controls for all filters. After a filter has been changed the operating hours counter must be reset.

- Open the menu as follows:

☰ button

- ▶ Further settings
  - ▶ Filter maintenance
    - ▶ Coarse filter or HEPA filter

⚠ The operating hours counter must only be reset when the filter has been changed.

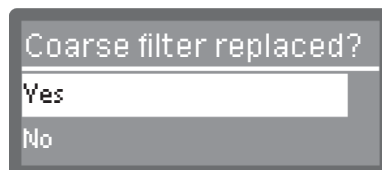

- Yes

The operating hours counter will be reset for the new filter.

- No

The counter will not be reset.

- Select an option using the ^ and v arrow buttons.
- Confirm your selection with *OK*.

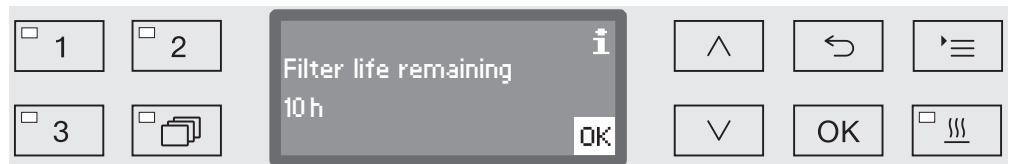

The remaining operating hours for this filter type are shown in the display.

- Confirm the message with *OK*.

Then you will be asked if you wish to reset the operating hours counter.

⚠ The operating hours counter must only be reset when the filter has been changed.



- Yes

The operating hours counter will be reset for the new filter.

- No

The counter will not be reset.

- Select an option using the  $\wedge$  and  $\vee$  arrow buttons.
- Confirm your selection with *OK*.

### Performance check

Adequate processing performance must be regularly confirmed by the user.

#### Test point for measuring sensors

The sensor test point for validation is located at the front right on the top of the machine under the lid or the worktop. To reach the access point, the lid of the machine must be removed or the machine must be pulled out from under the worktop.

- Open the door.

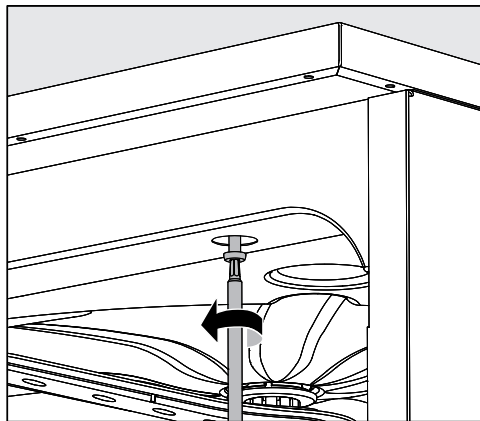

- Unscrew the fixing screws.
- Then remove the safety screws on the back of the machine from the **lid** and lift the **lid** to remove it.

Or

- Pull the washer-disinfector out by approx. 15 cm from under the **worktop**.

**Test programmes** Various programmes are available for monitoring cleaning performance in routine testing. The test programmes are not separate processing programmes. Rather, they are additional functions that can be activated prior to starting any processing programme.

The test programmes interrupt the programme sequence automatically at specified points. The interruption is indicated by an audible signal tone and message on the display. The Miele Customer Service Department can set the duration of the interruption to between 10 seconds and approx. 42 minutes. During this time period, measurements can be made or the door can be opened to obtain a sample.

To prevent cooling of the wash chamber, do not keep the door open too long.

After the time period elapses, the programme sequence continues automatically. If the door has been opened, the programme cannot resume until the door has been closed again.

If a measurement or sample is not needed, you can resume the programme sooner by pressing the *Start/Stop* button.

In addition, the door can be opened at any time during the drying phase to check the dryness of the wash load. In this way, you can determine the optimal drying time.

The following test programmes can be selected:

- Laboratory

The programme sequence can be paused in each wash block immediately before the wash fluid is drained away.

- Validation

The programme sequence is interrupted at the following points:

- before the wash fluid is drained away in the final wash block,
- after the interim rinse before the wash fluid is drained away,  
and
- after water intake and before draining in the final rinse block.

# Maintenance

---

## Activating a test programme

Test programmes are valid for only one programme sequence each time. A test programme must be selected again for further tests.

- Open the menu as follows:

☰ button

▶ Further settings

▶ Test programme



- No

The menu is exited without selecting a programme.

- Laboratory

Activates the Laboratory test programme

- Validation

Activates the Validation test programme

- Select an option using the ^ and v arrow buttons.

- Press OK to activate the test programme for the next programme start.

You can now start the performance test.

- Select and start a programme using the programme selection buttons or via the programme list.

The programme will be identified in the bottom line as Test programme during the programme sequence.



If you want to deactivate the test programme before the performance test you need to go to the next menu level up and select the No option.

The following guide should help you to find the reason for a fault and to correct it. However, please observe the following:

 Repairs may only be carried out by the Miele Customer Service Department. Unauthorised repairs can expose the user to considerable risk.

To avoid unnecessary customer service visits, check that the fault has not been caused by incorrect operation when a fault message first appears.

### Technical faults and messages

Problem	Cause and remedy
<b>The display is dark and all LEDs are out.</b>	The machine is not switched on. <ul style="list-style-type: none"> <li>■ Switch the machine on using the  button.</li> </ul>
	A fuse is defective or has tripped. <ul style="list-style-type: none"> <li>■ Refer to the minimum fuse rating on the data plate.</li> <li>■ Reset the trip switch.</li> <li>■ If the fuse trips again, call the Miele Customer Service Department.</li> </ul>
	The machine is not plugged in, or connected to the power supply. <ul style="list-style-type: none"> <li>■ Insert the plug and switch on at the socket.</li> </ul>
<b>The machine has switched itself off.</b>	This is not a fault. The Auto-Off function switches the machine off automatically after a pre-set duration to save energy. <ul style="list-style-type: none"> <li>■ Switch the machine on using the  button.</li> </ul>
<b>The time appears on the display.</b>	This is not a fault. The machine is ready for use. <ul style="list-style-type: none"> <li>■ Press any button to reactivate the machine.</li> </ul>
<b>Interruption to the power supply during operation</b>	If a temporary interruption to the power supply occurs during a programme sequence, no action is required. The programme will continue after the interruption. If the temperature in the wash cabinet drops below the minimum value required for the programme block during the interruption to the power supply, the programme block will be repeated. In the case of an interruption to the power supply of $\geq 20$ hours, the entire programme will be repeated. Each interruption to the power supply is reported in the process documentation.
Next service due on:	This is not a fault. The Miele Customer Service Department has recommended a date for the next service visit. <ul style="list-style-type: none"> <li>■ Please contact the Miele Customer Service Department to arrange a service visit.</li> </ul>

## Problem solving guide

### Dispensing/Dispensing systems

 Caution when handling chemical agents.

For all chemical agents, the chemical agent manufacturer's safety instructions as given on their safety data sheets must be observed.

Problem	Cause and remedy
DOS Refill	<p>During a programme sequence a low level of liquid chemical agent in a container has been identified.</p> <ul style="list-style-type: none"> <li>■ Replace the empty container with a full one.</li> </ul>
Programme could not be started. Vent DOS	<p>A programme cannot be started because ...            ... there is air in the dispensing system.            ... the dispensing system has been sucked completely dry.</p> <ul style="list-style-type: none"> <li>■ Check the level in the supply container. Replace an empty container with a full one, if necessary.</li> <li>■ Vent the dispensing system.</li> </ul>
Dispensing system DOS venting	<p>This is not a fault.            The dispensing system will now be automatically vented.            Wait until the venting process is finished.</p>
Venting DOS cancelled. Venting must be repeated	<p>Venting of the dispensing system was cancelled because an insufficient flow rate was identified. A dispensing hose may be kinked or the siphon blocked.</p> <ul style="list-style-type: none"> <li>■ Check the dispensing hose for kinks and leaks. Position it so that it cannot become kinked.</li> <li>■ Check the suction aperture of the siphon for blockages and remove these as necessary.</li> <li>■ Start the venting process again.</li> </ul> <p>Contact the Miele Customer Service Department if there are leaks in the dispensing hose or a fault with the siphon.</p>
Check container/lance DOS	<p>Little or no flow has been identified.</p> <ul style="list-style-type: none"> <li>■ Check the level in the supply container. Replace an empty container with a full one, if necessary.</li> <li>■ Check the suction aperture of the siphon for deposits.</li> <li>■ Vent the dispensing system.</li> </ul> <p>The dispensing hose is blocked.</p> <ul style="list-style-type: none"> <li>■ Remove any kinks from the dispensing hose. Position it so that it cannot become kinked.</li> <li>■ Check the dispensing hose for leaks.</li> <li>■ Vent the dispensing system.</li> </ul> <p>Contact Miele Service if there are leaks in the dispensing hose or a fault with the siphon.</p>

Highly viscous (thick) process chemicals can affect the dispenser monitoring and lead to inaccurate data. In this instance, please contact the Miele Customer Service Department for advice.

### Insufficient salt/Water softener

Problem	Cause and remedy
Refill salt	<p>Salt is running low in the water softener.</p> <ul style="list-style-type: none"> <li>■ Refill the reactivation salt before starting the next programme.</li> </ul>
Machine locking out Insufficient salt	<p>Salt in the water softener is completely depleted and reactivation is no longer possible. The machine is locked for further use.</p> <ul style="list-style-type: none"> <li>■ Refill the reactivation salt.</li> </ul>
Salt container empty, Programme locked	<p>The water softener cannot reactivate because there is insufficient salt. The machine is locked for further use.</p> <ul style="list-style-type: none"> <li>■ Refill the reactivation salt.</li> </ul> <p>The lock is lifted a couple of seconds after refilling the salt reservoir. Reactivation will occur automatically during the next programme sequence.</p>
Salt container lid not properly closed	<p>The salt container is not closed properly.</p> <ul style="list-style-type: none"> <li>■ Close the container properly.</li> </ul>
	<p>Salt residues are preventing it from closing.</p> <ul style="list-style-type: none"> <li>■ Remove all residues from the funnel, the lid, and the seal. <b>Do not use</b> running water as this can cause the salt container to overflow.</li> <li>■ Close the container properly.</li> </ul>
	<p>The salt container flap has sprung open during a programme.</p> <div style="border: 1px solid black; padding: 5px; margin: 5px 0;"> <p> When the door is opened, hot steam and chemical agents can escape!</p> </div> <ul style="list-style-type: none"> <li>■ Open the door and close the container flap.</li> </ul>



## Problem solving guide

---

### Cancel with fault code

If a programme is cancelled and a fault code appears, e.g. Fault XXX (where XXX represents a number), there could be a serious technical fault.

In the event of a programme being cancelled and a fault code being shown:

- Switch the washer-disinfector off using the  button.
- Wait approximately 10 seconds before switching the machine on again with the  button.
- Acknowledge the fault code by entering your PIN code.
- Start the previously selected programme again.

If the same message appears again:

- Make a note of the error message.
- Switch the washer-disinfector off using the  button.
- Contact the Miele Customer Service Department.



Please also read the notes regarding the following fault codes.

Problem	Cause and remedy
Fault 403-405	A programme has been cancelled because water intake by the machine was insufficient or severely restricted. <ul style="list-style-type: none"><li>■ Open the stopcocks fully.</li><li>■ Follow the additional information given in the Check water inlet message.</li></ul>
Fault 406-408	A programme was cancelled because the water flow rate is insufficient. <ul style="list-style-type: none"><li>■ Check whether the stopcocks are fully opened.</li><li>■ Please refer to the information regarding minimum flow pressure in “Connection to the water supply” and “Technical data”.</li><li>■ Check the filters in the water supply.</li><li>■ In this instance, please contact the Miele Customer Service Department for advice.</li></ul>
Fault 412-414	A programme was cancelled because the water flow rate is too high. <ul style="list-style-type: none"><li>■ Refer to the information regarding recommended maximum flow pressure and maximum permissible static water pressure in “Connection to the water supply” and “Technical data”.</li><li>■ In this instance, please contact the Miele Customer Service Department for advice.</li></ul>
Fault 422	A programme was cancelled because the conductivity of the supplied DI water is too high. <ul style="list-style-type: none"><li>■ Check your system for DI water.</li></ul>



Problem	Cause and remedy
Fault 426, 526	<p>Wash pressure is too low.</p> <ul style="list-style-type: none"> <li>– Wash pressure is too low due to a heavy build-up of foam. Spilled rinsing agent may not have been cleaned up after being added. <ul style="list-style-type: none"> <li>■ Follow the instructions regarding foam build-up in “Chemical processes and technology”.</li> <li>■ Start the Rinsing programme in order to clean the wash cabinet.</li> </ul> </li> <li>– The load carriers were loaded incorrectly or overloaded. <ul style="list-style-type: none"> <li>■ Only use mobile units, baskets, modules and inserts suitable for the particular application.</li> <li>■ Arrange hollow or deep-sided load items so that water runs off them freely.</li> </ul> </li> <li>– The water lines are clogged or leaking. <ul style="list-style-type: none"> <li>■ Check and clean the filters in the wash cabinet and spray arms.</li> <li>■ Check the injector manifolds for possible leaks, e.g.: <ul style="list-style-type: none"> <li>– Are all caps and end caps in place?</li> <li>– Are all connections fitted with nozzles, irrigation sleeves, hose adapters or other irrigation connectors?</li> <li>– Are installed silicone hoses undamaged?</li> </ul> </li> <li>■ Check the washer’s water connectors in the back panel of the wash cabinet to ensure that they are attached tightly, and remove any blockages.</li> </ul> </li> <li>– The amount of water is insufficient for the application. <ul style="list-style-type: none"> <li>■ Increase the amount of water (see “Programme settings”). If necessary, consult the Customer Service Department.</li> </ul> </li> </ul>
Fault 433	<p>Protruding load items or other objects, e.g. towels, are preventing the door from being closed properly by the Comfort lock.</p> <ul style="list-style-type: none"> <li>■ Remove all objects and sort the load items so that they do not obstruct the door.</li> <li>■ Close the door.</li> </ul>

## Problem solving guide

Problem	Cause and remedy
Fault 438	<p>The door seal sticks.</p> <ul style="list-style-type: none"> <li>■ Clean the door seal.</li> </ul> <p>Heavy objects in front of the cleaning machine can impede the automatic opening of the door by the Comfort door lock.</p> <ul style="list-style-type: none"> <li>■ Do not place (heavy) objects in front of the door of the cleaning machine.</li> </ul> <p>The Comfort door lock is blocked.</p> <ul style="list-style-type: none"> <li>■ Try to open the door carefully (without using force) by pulling on the door handle.</li> </ul> <p>If the door is still blocked:</p> <ul style="list-style-type: none"> <li>■ Open the door using the emergency release.</li> <li>■ Close the door and try to open it again using the  button.</li> </ul> <p>If it is still blocked:</p> <ul style="list-style-type: none"> <li>■ Contact the Miele Customer Service Department.</li> </ul>
Fault 440	<p>The float switch in the base of the machine has not been activated. The switch might be blocked.</p> <ul style="list-style-type: none"> <li>■ Remove the filter combination.</li> <li>■ Check the float switch to make sure it moves freely. The float switch is located in the base of the machine behind the spray arm.</li> </ul>
Fault 460-462	<p>A programme was interrupted due to the spray arm speed dropping below the set value.</p> <ul style="list-style-type: none"> <li>- Items are obstructing the machine or basket spray arms.</li> <li>■ Arrange the load so that the spray arms can turn easily and start the programme again.</li> <li>- Wash pressure is too low due to a heavy build-up of foam.</li> <li>■ Follow the instructions regarding foam build-up in “Chemical processes and technology”.</li> </ul>
Fault 492, 504	<p>A programme has been cancelled because there is not enough spray pressure. The filters in the wash cabinet may be blocked.</p> <div style="border: 1px solid black; padding: 5px; margin: 10px 0;"> <p> Danger of injury from glass shards, needles, etc. retained in the filters.</p> </div> <ul style="list-style-type: none"> <li>■ Check and clean the filters in the wash cabinet (see “Maintenance/Cleaning the filters in the wash cabinet”).</li> </ul>

Problem	Cause and remedy
Fault 518–521	<p>No flow was detected when dispensing from an external container.</p> <div style="border: 1px solid black; padding: 5px; margin: 5px 0;"> <p> Take care when using process chemicals. For all process chemicals, the manufacturer's safety instructions as given on their safety data sheets must be observed.</p> </div> <ul style="list-style-type: none"> <li>■ Check the level in the containers and replace empty ones with filled ones.</li> <li>■ Check the suction apertures of the siphons and remove any deposits.</li> <li>■ Check the hose connections on the siphons, the washer-disinfector and any dispensing modules.</li> <li>■ Remove any kinks from the dispensing hoses and check the hoses for leaks. Position the dispensing hoses so that they cannot kink.</li> <li>■ Vent the dispensing systems.</li> </ul> <p>If you identify any leaks in the dispensing hoses or defects on the siphons, contact the Miele Customer Service Department.</p>
Fault 550	<p>The waterproof system has been activated. One of the water supply hoses might have a leak.</p> <ul style="list-style-type: none"> <li>■ Close the stopcocks.</li> <li>■ Contact the Miele Customer Service Department.</li> </ul>
Fault 555	<p>Too much water has accumulated in the steam condenser. Wash water may have been diverted behind the protective panel of the steam condenser on the back wall of the wash cabinet because of angled load items or injector nozzles.</p> <ul style="list-style-type: none"> <li>■ When installing angled injector nozzles and sorting load items, ensure that the wash water outlets point towards the centre of the wash cabinet.</li> <li>■ Restart the cleaning machine. Excess water is pumped out automatically.</li> </ul>

## Problem solving guide

Problem	Cause and remedy
Fault 559	<p>There is a problem with the process documentation interface. The machine has detected a module for an Ethernet interface, but only a serial interface (RS232) is activated in the controls.</p> <p>Deactivate the RS232 interface:</p> <ul style="list-style-type: none"> <li>■ Open the menu for configuring the interface Further settings/Interface and then select Ethernet.</li> <li>■ Wait approx. 90 seconds. The Ethernet module XKM 3000 L Med needs this time for initialisation. It may be necessary to reconfigure the interface.</li> </ul> <p>Or</p> <ul style="list-style-type: none"> <li>■ Replace the Ethernet module XKM 3000 L Med with a XKM RS232 10 Med module to set up a serial interface.</li> </ul>
Fault 578	<p>The peak load cut-out has lasted longer than 3 hours.</p> <ul style="list-style-type: none"> <li>■ Have your electrical system and your energy management system tested by a suitably qualified person.</li> </ul>





## Process-related faults and messages

Problem	Cause and remedy
Fit a new coarse filter!	<p>The maximum permissible operating hours for the coarse filter have been reached.</p> <ul style="list-style-type: none"> <li>■ Replace the coarse filter with a new one.</li> <li>■ Reset the operating hours counter for the coarse filter.</li> </ul>
Fit a new HEPA filter!	<p>The maximum permissible operating hours for the HEPA filter have been reached.</p> <ul style="list-style-type: none"> <li>■ Replace the HEPA filter with a new one.</li> <li>■ Reset the operating hours counter for the HEPA filter.</li> </ul>
Drying during programme deactivated	<p>Drying cannot be selected at the start of a programme because drying is not available for the selected programme.</p> <ul style="list-style-type: none"> <li>■ Start the programme without drying.</li> </ul> <p>Or:</p> <ul style="list-style-type: none"> <li>■ Have the drying parameters for this programme adjusted by the Miele Customer Service Department.</li> </ul>
Wrong code entered	<p>The PIN code entered is not the same as the code saved.</p> <ul style="list-style-type: none"> <li>■ Enter the PIN code again.</li> <li>■ Report the loss of the PIN code to the Miele Customer Service Department.</li> </ul>

Problem	Cause and remedy
Test programme: test object can now be removed	<p>This is not a fault.</p> <p>A test programme is running to check performance. At certain points in the programme the sequence is interrupted so that samples can be taken.</p> <ul style="list-style-type: none"> <li>■ Take a sample.</li> </ul> <p>or</p> <ul style="list-style-type: none"> <li>■ Wait. The programme will continue automatically in approx. 30 seconds.</li> </ul> <p>or</p> <ul style="list-style-type: none"> <li>■ Continue the programme without delay by pressing the <i>Start/Stop</i> button.</li> </ul>
Programme cancelled	<p>This is not a fault.</p> <p>A programme which was running was cancelled by the user.</p> <div style="border: 1px solid gray; padding: 5px; margin-top: 10px;"> <p> The wash cabinet interior can be very hot. When the door is opened, hot steam and chemical agents can escape. Protective measures for personal safety must be observed.</p> </div>
Programme continued	<p>This is not a fault.</p> <p>The process of cancelling a programme was not completed.</p> <p>The programme which was running continued without interruption.</p>
Peak load cut-out	<p>This is not a fault.</p> <p>Individual components of the machine are paused while there is a peak load signal from your energy management system.</p>
All settings reset	<p>This is not a fault.</p> <p>A user has restored factory default settings.</p> <ul style="list-style-type: none"> <li>■ Confirm the message with <i>OK</i>.</li> </ul>
All programme settings reset	<p>This is not a fault.</p> <p>A user has restored the factory setting for the programme.</p> <ul style="list-style-type: none"> <li>■ Confirm the message with <i>OK</i>.</li> </ul>

## Problem solving guide

### Door

Problem	Cause and remedy
<b>The door is open a fraction and cannot be closed using the  button.</b>	<p>This is not a fault. The Comfort door lock has opened the door slightly at the end of the programme.</p> <ul style="list-style-type: none"> <li>■ Open the door. The door can now be closed completely again using the  button.</li> </ul>
Door not closed properly	<p>Slamming the door can result in problems with the Comfort door lock.</p> <ul style="list-style-type: none"> <li>■ Open and close the door.</li> </ul> <p>If the same message appears again:</p> <ul style="list-style-type: none"> <li>■ Contact the Miele Customer Service Department.</li> </ul>
Warning. Cabinet hot! Open anyway?	<p>When pressing the  button, be aware that the temperature in the wash cabinet is over 70 °C.</p> <div style="border: 1px solid gray; padding: 5px; margin: 5px 0;"> <p> When the door is opened, hot steam and chemical agents can escape!</p> </div> <ul style="list-style-type: none"> <li>■ Open the door only when strictly necessary.</li> </ul>
Obstruction sensor	<p>The door was closed before the door lock rail was fully retracted.</p> <ul style="list-style-type: none"> <li>■ Open the door.</li> <li>■ The door lock rail must be fully retracted before you close the door again.</li> </ul>
Emergency release	<p>The door was opened using the emergency release.</p> <ul style="list-style-type: none"> <li>■ See “Opening the door using the emergency release”.</li> </ul>

### Unsatisfactory cleaning and corrosion

Problem	Cause and remedy
<b>There are white deposits on the wash load.</b>	<p>The water softener is set too low.</p> <ul style="list-style-type: none"> <li>■ Set the water softener to the correct water hardness.</li> </ul> <p>There is no salt in the salt reservoir.</p> <ul style="list-style-type: none"> <li>■ Refill the reactivation salt.</li> </ul> <p>The quality of the water for the final rinse was insufficient.</p> <ul style="list-style-type: none"> <li>■ Use water with a low conductance value.</li> <li>■ If the machine is connected to a water softening cartridge, check it and replace as necessary.</li> </ul> <p>The water from the AD water connection is not sufficiently softened.</p> <ul style="list-style-type: none"> <li>■ Check the pre-selected water softening units. If necessary, replace the water softening cartridge with a new one.</li> </ul>

Problem	Cause and remedy
<b>The cleaning result is unsatisfactory.</b>	<p>Mobile units, baskets, modules and inserts were not suitable for the load.</p> <ul style="list-style-type: none"> <li>■ Select mobile units, baskets, modules and inserts which are suitable for the task.</li> </ul>
	<p>Mobile units, baskets, inserts and modules were incorrectly loaded or overloaded.</p> <ul style="list-style-type: none"> <li>■ Arrange the wash load correctly according to the information in the Operating instructions.</li> <li>■ Avoid overloading the mobile units, baskets, modules and inserts.</li> </ul>
	<p>The programme was not suitable for the soiling.</p> <ul style="list-style-type: none"> <li>■ Select a suitable programme.</li> </ul> <p>or</p> <ul style="list-style-type: none"> <li>■ Adjust the parameters to suit the task.</li> </ul>
	<p>A spray arm is blocked.</p> <ul style="list-style-type: none"> <li>■ Ensure the spray arms are not obstructed when arranging the wash load.</li> </ul>
	<p>Injector nozzles in the mobile units, baskets, modules or spray arms are blocked.</p> <ul style="list-style-type: none"> <li>■ Check the nozzles and clean them as necessary.</li> </ul>
	<p>The filters in the wash cabinet are dirty.</p> <ul style="list-style-type: none"> <li>■ Check the filters and clean them if necessary.</li> </ul>
	<p>Mobile units, baskets or modules were not correctly fitted to the water connection.</p> <ul style="list-style-type: none"> <li>■ Check the adapter.</li> </ul>
	<b>Items made of glass are showing signs of corrosion.</b>
<p>Neutralisation has not taken place during the programme.</p> <ul style="list-style-type: none"> <li>■ Check the level in the supply container and vent the dispensing system if necessary.</li> </ul>	
<p>The wash temperature was too high.</p> <ul style="list-style-type: none"> <li>■ Select a different programme.</li> </ul> <p>or</p> <ul style="list-style-type: none"> <li>■ Reduce the wash temperature.</li> </ul>	
<p>Cleaning agents used were too alkaline.</p> <ul style="list-style-type: none"> <li>■ Use a milder cleaning agent.</li> </ul> <p>or</p> <ul style="list-style-type: none"> <li>■ Reduce the concentration of the cleaning agent.</li> </ul>	

## Problem solving guide

Problem	Cause and remedy
<b>Stainless steel items are showing signs of corrosion.</b>	The stainless steel is of insufficient quality for machine reprocessing. <ul style="list-style-type: none"> <li>■ Only use stainless steel items made of high quality stainless steel and follow the instructions of the manufacturer regarding machine reprocessing.</li> </ul>
	The chloride content in the water is too high. <ul style="list-style-type: none"> <li>■ Have a water analysis check carried out. Connection to an external water processing unit and the use of demineralised water may be necessary.</li> </ul>
	Neutralisation has not taken place during the programme. <ul style="list-style-type: none"> <li>■ Check the level in the supply container and vent the dispensing system if necessary.</li> </ul>
	Rust or superficial rust has built up in the wash cabinet, e.g. due to an excessively high iron content in the water or rust on other wash load items. <ul style="list-style-type: none"> <li>■ Check the installation.</li> <li>■ Discard any rusty items.</li> </ul>

### Spray arm monitoring/conductivity/wash pressure

Problem	Cause and remedy
Spray arm monitoring - upper spray arm: Spray arm blocked or excessive foaming <b>or</b> Spray arm monitoring - lower spray arm: Spray arm blocked or excessive foaming <b>or</b> Spray arm monitoring - mobile unit spray arm 1 - : spray arm blocked or excessive foaming	The set spin speed has not been reached. <ul style="list-style-type: none"> <li>– Load items are obstructing the machine or basket spray arms. <ul style="list-style-type: none"> <li>■ Arrange the load items so that the spray arms can turn easily and start the programme again.</li> </ul> </li> <li>– The relevant spray arm is blocked. <ul style="list-style-type: none"> <li>■ Clean the spray arm.</li> <li>■ Check whether the filters in the wash cabinet are clean and correctly inserted.</li> <li>■ Start the programme again.</li> </ul> </li> <li>– Wash pressure is too low due to a heavy build-up of foam. <ul style="list-style-type: none"> <li>■ Follow the instructions regarding foam build-up in “Chemical processes and technology”.</li> <li>■ Start the Rinsing programme in order to clean the wash cabinet.</li> <li>■ Then reprocess the load items again.</li> </ul> </li> </ul>



Problem	Cause and remedy
Conductivity level too high: Actual value: $\mu\text{S}/\text{cm}$ Max value: $\mu\text{S}/\text{cm}$	Carry-over of conductive substances during reprocessing. ■ Check the process.
	Empty or faulty water softener or demineralisation system. ■ Check external water softener or demineralisation systems. ■ Reactivate the systems if necessary.
	Work on the on-site water supply. ■ Contact a suitably qualified plumber.
	Plumbing connections transposed. ■ Observe the markings on the plumbing connections (see “Connection to the water supply”).
Conductivity level exceeds max. value	If the level drops below the measuring range, the conductivity cannot be determined. ■ Contact the Miele Customer Service Department.
Conductivity module requires calibration	The conductivity meter must be recalibrated. ■ Contact the Miele Customer Service Department.
Conductivity module communication error	The connection to the conductivity meter has been interrupted. ■ Contact the Miele Customer Service Department.
Wash pressure exceeds tolerance	The wash pressure differs from the reference value. Possible causes of fluctuations in the wash pressure include: - Defective water connections, - Open adapters, - Foam build-up. ■ Identify and resolve the cause of this. ■ The programme is not interrupted. Nevertheless, you must reprocess the load.
Wash pressure fluctuating too much	A programme was interrupted because of severe fluctuations in the wash pressure. Possible causes of fluctuations in the wash pressure include: - Defective water connections, - Open adapters, - Foam build-up. ■ Identify and resolve the cause of this. ■ Reprocess the load again.

## Problem solving guide

### Water inlet and drainage

Problem	Cause and remedy
Check water inlet	One or more stopcocks are closed. ■ Open the stopcocks.
	There was insufficient water in the machine. ■ Clean the water intake filters. ■ Open the stopcocks fully.
	The supply pressure at the water connection is too low. ■ Refer to the specifications for supply pressure in the “Technical data”. ■ Contact a suitably qualified installer.
Check drainage	A programme was cancelled because the water in the wash cabinet is only being pumped away slowly or not at all. - The drain hose is blocked. ■ Remove any kinks or large loops in the drain hose. ■ Start the programme again. - The filters in the wash cabinet are blocked. ■ Clean the filters in the wash cabinet. <div style="border: 1px solid black; padding: 5px;"> Danger of injury from glass shards, needles, etc. retained in the filters.</div>
	■ Start the programme again. - The drain pump or the non-return valve is blocked. ■ Clean the access to the drain pump and the non-return valve. ■ Start the programme again. - The drainage system cannot take in enough water because it is blocked. ■ Contact a suitably qualified plumber.

### Noises

Problem	Cause and remedy
<b>Knocking noise in the wash cabinet.</b>	<p>One or more spray arms are knocking against the wash load.</p> <ul style="list-style-type: none"> <li>■ Cancel the programme. To do this follow the instructions in “Cancelling a programme”.</li> <li>■ Arrange the wash load so it cannot obstruct the spray arms.</li> <li>■ Make sure the spray arms can rotate freely.</li> <li>■ Start the programme again.</li> </ul>
<b>Rattling noise in the wash cabinet.</b>	<p>Items are insecure in the wash cabinet.</p> <ul style="list-style-type: none"> <li>■ Cancel the programme. To do this follow the instructions in “Cancelling a programme”.</li> <li>■ Rearrange the load so that items are secure.</li> <li>■ Start the programme again.</li> </ul>
<b>Knocking noise in the water pipes.</b>	<p>This may be caused by the on-site installation or the cross-section of the piping. It has no influence on the function of the machine.</p> <ul style="list-style-type: none"> <li>■ Contact a suitably qualified plumber.</li> </ul>

### Printer/interface

Problem	Cause and remedy
Serial printer fault: no paper	<p>The printer has run out of paper.</p> <ul style="list-style-type: none"> <li>■ Replenish the paper.</li> </ul>
Serial printer fault: offline	<p>The washer-disinfector cannot connect to the printer.</p> <ul style="list-style-type: none"> <li>■ Switch the printer on.</li> <li>■ Check the connection between the washer-disinfector and the printer.</li> <li>■ If in doubt, have the configuration of the interface checked by a suitably qualified person.</li> </ul> <p>If the printer has been replaced, the printer type must be adjusted in the interface configuration.</p>
Serial printer fault: general fault	<p>The printer is not ready for operation.</p> <ul style="list-style-type: none"> <li>■ Check the printer for fault messages.</li> <li>■ Change the printer cartridge if necessary.</li> </ul>
Network down	<p>The communication module has identified a network interruption or cannot establish a connection.</p> <ul style="list-style-type: none"> <li>■ Consult your network administrator.</li> </ul> <p>If the problem cannot be resolved:</p> <ul style="list-style-type: none"> <li>■ Contact the Miele Customer Service Department.</li> </ul>

### Cleaning the drain pump and non-return valve

If water has not been pumped away at the end of a programme there may be a foreign object in the drain pump or blocking the non-return valve.

- Take the filter combination out of the wash cabinet (see “Maintenance/Cleaning the filters in the wash cabinet”).

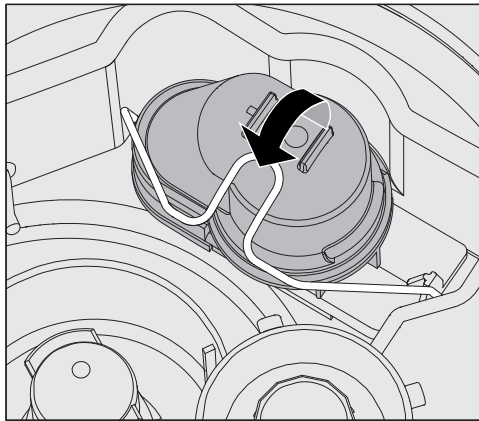

- Lift the locking clamp.
- Lift out the non-return valve and rinse well under running water.
- Make sure that the vent on the external part of the non-return valve is not blocked. (This vent is only visible when the non-return valve has been taken out.) If it is blocked, use a pointed object to release the blockage.

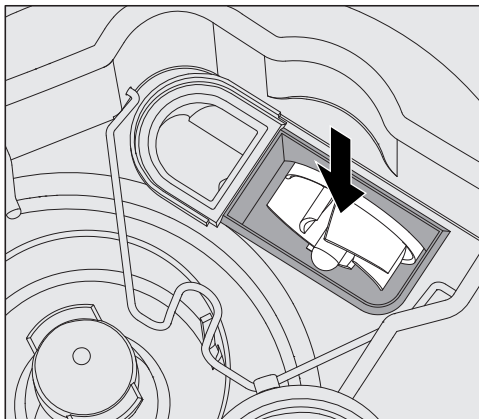

The drain pump impeller is situated under the non-return valve (see arrow).

- Check the impeller for blockages and remove them if necessary.
- Carefully replace the non-return valve and secure it with the clamp.

### Cleaning the water intake filters

Filters are incorporated into the water inlet connection on the hose to protect the water inlet valve. If these filters get dirty they must be cleaned as otherwise too little water will flow into the wash cabinet.

 The plastic housing on the water inlet valve contains an electrical component. It must not be dipped in water.

#### To clean the filter

- Disconnect the cleaning machine from the mains (switch the cleaning machine off, unplug it or disconnect or disable the fuse).
- Close the stopcock.
- Unscrew the water inlet valve.

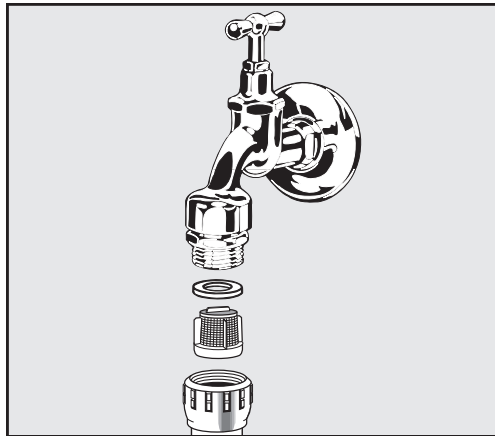

- Remove the seal from the screw thread.
- Pull the filter out using combination or pointed pliers.
- Clean the filter or replace it if necessary.
- Replace the filter and seal, making sure they are sitting correctly.
- Screw the water inlet valve onto the stopcock. Ensure that the screw thread goes on straight and not cross-threaded.
- Open the stopcock. If water leaks out, the screw thread may not be connected securely or it may have been screwed on at an angle. Fit the water inlet valve straight and screw it in place.

#### Retrofitting the large-surface filter

If the water contains a high level of insoluble components, a large-surface filter can be installed between the stopcock and the water inlet hose.

The large-surface filter is available from the Miele Customer Service Department.

#### **IMPORTANT**

##### **UK, Australia and New Zealand**

For the UK, Australia and New Zealand a non-return check valve is required between the tap and optional filter.

### Contacting the Customer Service Department

 Repairs may only be carried out by the Miele Customer Service Department or an authorised technician. Unauthorised repairs can expose the user to considerable risk.

To avoid unnecessary service visits, check that the fault has not been caused by incorrect operation when a fault message first appears. Please refer to the relevant instructions in the “Problem solving guide”.

If, having followed the advice in the operating instructions, you are still unable to resolve a problem, please notify the Miele Customer Service Department.

Contact details can be found at the end of these operating instructions.

When contacting the Customer Service Department, please quote the model and serial number of your machine. This information can be found on the data plate. There is one data plate on the side of the door and another on the back of the machine.

Please tell the Customer Service Department the fault message or code shown in the display.

### Software version

When contacting the Service department you may need the version number of individual components of control software. These can be called up as follows:

- Open the menu as follows:

☰ button

▶ Further settings

▶ Software version

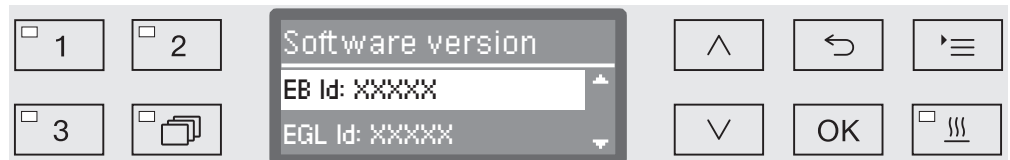

The software units are listed on the display. XXXXX stands for the relevant version number:

- EB ID: XXXXX

Software version of the control and display units in the control panel.

- EGL ID: XXXXX

Software version of the control board.

- EZL ID: XXXXX

Software version of the relay board.

- EFU ID: XXXXX

Software version of the frequency converter.

- LNG ID: XXXXX

Language package version.

You cannot change any settings in this menu.

Software updates and upgrades may only be undertaken by the Miele Customer Service Department.

- Exit the menu with the *OK* or ↶ buttons.

## Installation and levelling

Please refer to the installation diagram provided.

⚠ In order to reduce the risk of water damage, the area around the machine should be limited to furniture and fittings that are designed for use in commercial environments.

The machine must be stable and level.

Any unevenness in the floor level can be compensated for by adjusting the two front feet. The feet can be screwed out to a maximum of 8 mm.

With the feet screwed in the machine can be rolled backwards or forwards on fitted castors. To do this the machine must be raised up slightly at the front.

⚠ Do not lift the machine by the control panel or the drawer in the side unit.  
This could damage them.

⚠ Some metal parts pose a risk of injury/being cut.  
Wear cut-resistant protective gloves when transporting and setting up the machine.

⚠ For transport by means of a hand truck, the machine must be in its original packaging or placed on a stable, continuous support. Otherwise, components in the base of the machine can be damaged.

The machine is suitable for the following types of installation:

- Freestanding.
- Slot-in:

The machine can be installed beside other appliances or furniture or in a suitable niche. The niche must be at least 900 mm wide and 600 mm deep.

- Built-under:

The machine can be built under a continuous worktop or the draining board of a sink. The space provided must be at least 900 mm wide, 600 mm deep and 820 mm high.

Freestanding machines or machines installed in a niche must have the lid fitted.  
600 mm or 700 mm deep lids with additional side wall extensions are available from Miele.



## Fitting the lid

The lid must be screwed to the washer-disinfector. The side with the screw threads on the underside goes to the front and the side with the safety screw holders protruding downwards goes to the back.

Follow the fitting instructions supplied with the lid.

- Place the lid on the washer-disinfector so that it is flush with the machine.
- Tighten the two securing screws on the back of the machine.
- Open the door.

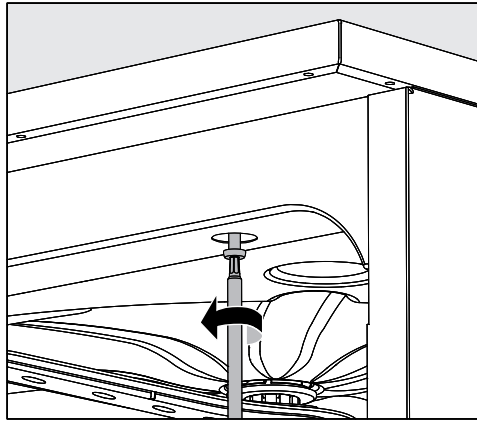

- Remove the cover caps on the left and right and tighten the fixing screws. Then replace the cover caps.

# Installation

## Building under a continuous worktop

### Steam condenser

To avoid steam damage to the worktop the protective foil supplied (25 x 58 cm, self-adhesive) must be applied underneath the worktop in the area of the steam condenser.

### Protective foil/ Worktop protector

The protective foil supplied protects the worktop from damage caused by steam when the door is opened. It should be positioned underneath the worktop above the machine door.

### Preventing heat build-up

During the drying phase, the hot exhaust air from the wash cabinet is released into the surrounding environment through the steam condenser at the rear of the machine. Sufficient ventilation must be ensured to prevent heat build-up and excessive condensation.

- Leave a minimum distance of 10 mm for air exchange between the machine and the worktop.
- If necessary ventilation grilles should be fitted in the side units.

### Securing to the worktop

To improve stability the machine must be secured to the worktop after it has been aligned.

- Open the door.

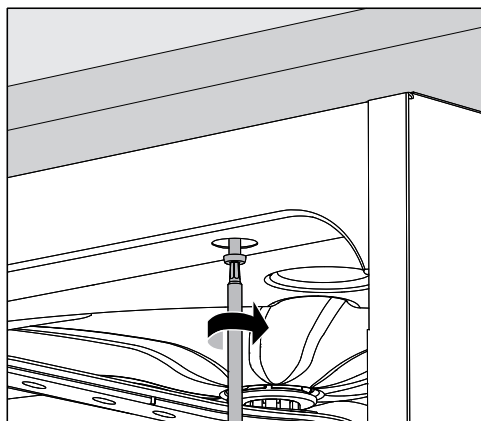

- Screw the machine to the continuous worktop through the holes in the front trim on the left and right.

Please contact the Miele Customer Service Department to secure it at the sides to adjacent cabinetry.

### Venting the circulation pump

⚠ The gaps between a built-in machine and adjacent cabinetry must not be sealed, e.g. with silicone sealant, as this could compromise ventilation of the circulation pump.

### **Electromagnetic compatibility (EMC)**

The machine has been tested for electromagnetic compatibility (EMC) in accordance with EN 61326-1 and is suitable for operation in commercial environments, such as hospitals, medical practices and laboratories and other similar environments which are connected to the mains power supply.

The machine's high frequency (HF) energy emissions are very low and are therefore unlikely to interfere with other electronic machines in the vicinity.

Flooring in the installation area must be wood, concrete or tiled. Synthetic flooring must be able withstand a relative humidity level of 30 % to minimise the risk of electrostatic discharges.

The quality of the power supply should comply with that found in a typical commercial or hospital environment. Check that the power supply voltage is within a range of +/-10 % (UK: -6/+10 %) of its nominal value.

## Electrical connection

---

⚠ All electrical work must be carried out by a suitably qualified electrician in accordance with local and national safety regulations.

- The electrical installation must comply with current local and national safety regulations (e.g. DIN VDE 0100 in Germany).
- The connection to the power supply must be via a suitably rated plug and socket and must comply with national regulations. The socket must be accessible after the machine has been installed. An electrical safety test must be carried out after installation and after any maintenance work.
- If the machine is hard-wired to the power supply, a power switch with all-pole isolation must be installed. The power switch must be designed to operate at the rated current for the machine, must ensure a 3 mm gap between all open contacts, and must be able to be locked in the off position.
- Equipotential bonding should be carried out if required.
- The rated loads are specified on the data plate and in the circuit diagram supplied with the machine.
- For increased safety, it is recommended to protect the machine with a suitable residual current device (RCD) with a trip current of 30 mA.
- If replacing the power cable, use only original replacement parts from the manufacturer or a suitable cable with core cable ends.

Further notes on electrical connection are given on the Installation diagram supplied with the machine.

The machine must only be operated with the voltage, frequency and fusing shown on the **data plate**.

Depending on country this machine **can be converted to a different type of power supply** in accordance with the conversion diagram and wiring diagram supplied.

A **data plate** can be found on the inside of the door and another on the back of the machine.

The wiring diagram is supplied with the machine.

### Equipotential bonding connection

There is a screw connection point marked  $\nabla$  at the back of the machine, to which additional equipotential bonding can be connected if required.

## Peak-load negotiation

The machine is suitable for use in an energy management system. For this purpose, it must be technically adapted and the controls reset by the Miele Customer Service Department.

Please contact the Miele Customer Service Department for further information.

### Peak load management

In the event of a peak-load negotiation, some machine components such as the heater element will be switched off for a while. The machine will remain on during this period and the current programme will not be interrupted. If one of the components that is switched off is needed during the current programme stage, the programme duration will simply increase for the duration of the load negotiation.

The third line of the display will alert you to the peak-load negotiation, for example:

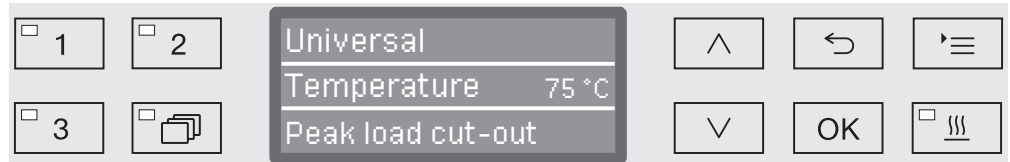

## Connection to the water supply

 The water inside the cleaning machine is not suitable for drinking!

- The cleaning machine must be connected to the water supply in strict accordance with local regulations.
- The water used must at least comply with European or national regulations for drinking water quality. If the water supply has a high iron content, there is a danger of corrosion occurring on load items made of stainless steel and on the cleaning machine itself. If the chloride content of the water exceeds 100 mg/l, the risk of corrosion to load items made of stainless steel in the machine will be further increased.
- In certain regions (e.g. mountainous areas), the water composition may cause precipitates to form, requiring the use of softened water in the steam condenser.
- The cleaning machine complies with the applicable European standards for the protection of drinking water.  
UK, Australia and New Zealand only: To comply with water regulation requirements, this machine must be connected to the potable water supply via the non-return check valve supplied with the machine.
- The washer-disinfector is supplied as standard for connection to cold water (blue coded hose) and hot water up to max. 65 °C (UK: max. 60 °C) (red coded hose). Connect the inlet hoses to the cold and hot water supply.
- If there is no hot water supply available, the inlet hose coded **red** must also be connected to the cold water supply.
- The intake hose without water protection device for the steam condenser is connected to the cold water supply.
- The **minimum flow pressure** for the cold water connection is 100 kPa pressure, for the hot water connection 40 kPa (UK: 100 kPa) pressure and for the DI water connection 30 kPa pressure.
- The **recommended flow pressure** is  $\geq 200$  kPa for the cold and hot water connections and  $\geq 200$  kPa for the DI water connection in order to avoid excessively long water intake times.
- The **maximum permissible static water pressure** is 1,000 kPa.
- If water pressure is not within the specified range, please contact the Miele Customer Service Department for advice.
- More information on AD water connection can be found at the end of this section.
- Stopcocks with a  $\frac{3}{4}$  inch screw thread must be provided on site for the connection. The valves must be easily accessible to allow the water inlet to be turned off when not in use.

- The water inlet hoses are approximately 1.7 m long pressure hoses, DN 10, with 3/4 inch screw thread. The filters in the screw threads must not be removed.

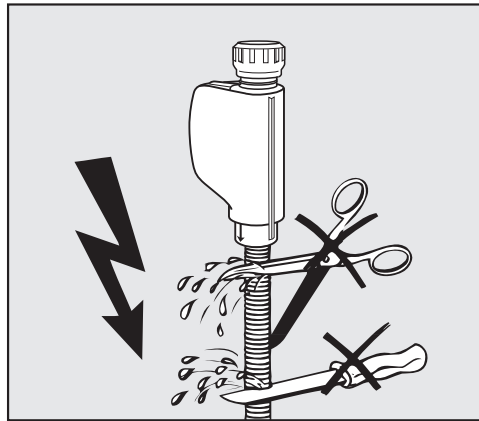

⚠ Do **not** shorten or otherwise damage the water inlet hoses supplied with the machine.

See also the installation plan supplied.

### **IMPORTANT**

#### **UK, Australia and New Zealand**

For the UK, Australia and New Zealand a non-return check valve is required between the tap and optional filter.

### **Retrofitting the large-surface filter**

If the water contains a high level of insoluble components, a large-surface filter can be installed between the stopcock and the water inlet hose.

The large-surface filter is available from the Miele Customer Service Department.

### **AD water connection for 30-1,000 kPa (UK: 100-1,000 kPa) pressure - pressure-resistant (optional)**

This machine can be optionally supplied for a pressurised system operating between 30-1,000 kPa (UK: 100-1,000 kPa). If the water pressure is below 200 kPa the water intake duration will be automatically increased.

- The pressure tested hose for AD water, coded green, has a 3/4 inch threaded union for connection to the onsite stopcock for AD water.

⚠ If the machine is not going to be connected to demineralised (DI) water, the DI water connection has to be deactivated by the Miele Customer Service Department. The intake hose remains on the back of the machine.

### **AD water connection for 8.5-60 kPa - without pressure (optional)**

The machine has to be converted for connection to 8.5-60 kPa pressure unless ordered as such at the factory. Installation of the pump must only be carried out by Miele Service.

With a pressureless AD water connection, the drainage point must be at least as high as the top of the machine. See installation instructions.

## Plumbing

---

**DI water ring line** The machine can be connected to a ring line system for DI water. For this purpose, it must be technically adapted and the controls reset by the Miele Customer Service Department.

Please contact the Miele Customer Service Department for further information.

### **IMPORTANT UK, Australia and New Zealand.**

This appliance must be installed according to AS/NZS 3500.1 (Australia and New Zealand) or in accordance with water regulations (UK). This appliance has been supplied with a separate backflow prevention device.

This machine must be connected to the potable water supply via the non-return valve (check valve) supplied with the machine.

Before making plumbing connections, ensure the appliance is disconnected from the mains power supply (switch off or unplug from the power supply).

- Turn off the mains water tap.
- Place the seals on both sides of the non-return valve.
- Connect the female end of the non-return valve to the mains water tap (3/4" thread).
- Connect the filter (optional accessory) to the male end of the non-return valve (3/4" thread).
- Connect the inlet hose to the filter (optional accessory).

Ensure that all connections are screwed into position correctly. The connection point is subject to mains water pressure.

- Turn on the tap slowly and check for leaks.

Correct the position of the seal and union if necessary.



### Connecting the drain hose

- A non-return valve is incorporated into the drain system in the machine to prevent drainage water flowing back into the machine via the drain hose.
- The machine drainage hose should be connected to a **separate** drain for the machine only. If no separate drain is available, we recommend connecting it to a dual-chamber siphon.
- The on-site connection point, **measured from the lower edge of the machine**, should be positioned at a height between 0.3 m and 1.0 m. If it is lower than 0.3 m, the drain hose must be laid in a coil at a height of at least 0.3 m.
- The drainage system must be able to accommodate a minimum drainage flow of 16 l/min.
- The drainage hose is approx. 1.4 m (Australia and New Zealand: 2.25 m) long and flexible with an internal diameter of 22 mm. Hose clips for the connection are supplied.
- The drain hose must not be shortened.
- The drain hose can be extended using a connection piece to attach a further length of hose up to 4.0 m long. The drainage length must not exceed 4.0 m.
- Drainage noise can be considerably reduced if the drainage hose is positioned in an arc at a minimum height of 0.6 m and a max. height of 1.0 m measured from the bottom edge of the washer-disinfector.

See installation diagram supplied.

## Technical data

Height with machine lid Height without machine lid	835 mm 820 mm
Width	898 mm
Depth Depth with door open	598 mm 1,200 mm
Wash cabinet dimensions: Height Width Depth of upper basket/lower basket	520 mm 530 mm 474 mm/520 mm
Weight (net)	98 kg
Max. load capacity of open door	37 kg
Voltage, rated load, fuse rating	See data plate
Connection cable	Approx. 1.8 m
Water temperature water connection: Cold water/steam condenser Hot water/DI water (optional)	Max. 20 °C Max. 65 °C (UK: max. 60 °C)
Static water pressure	Max. 1,000 kPa pressure
Minimum water connection flow pressure: Cold water/steam condenser Hot water Demineralised water (optional)	100 kPa pressure 40 kPa (UK: 100 kPa) pressure 30 kPa pressure
Recommended water connection flow pressure: Cold water/hot water Demineralised water (optional) Steam condenser	≥ 200 kPa pressure ≥ 200 kPa pressure ≥ 100 kPa pressure
DI water connection without pressure (optional)	8.5-60 kPa
Delivery head	Min. 0.3 m, max. 1.0 m
Drainage length	Max. 4.0 m
Operation (according to IEC/EN 61010-1): Ambient temperature Relative humidity maximum linear decrease to Relative humidity minimum	5 °C to 40 °C 80 % for temperatures up to 31 °C 50 % for temperatures up to 40 °C 10 %
Storage and transportation conditions: Ambient temperature Relative humidity Air pressure	- 20 °C to 60 °C 10 % to 85 % 500 hPa to 1060 hPa
Altitude above sea level (according to IEC/EN 61010-1)	Up to 2,000 m *
Protection category (according to IEC 60529)	IP20
Soiling level (according to IEC/EN 61010-1)	2
Overvoltage category (according to IEC 60664)	II
Noise level in dB (A), sound pressure LpA during cleaning and drying phases	< 70
Test certifications	VDE, EMC radio suppressed
CE marking	Machinery Directive 2006/42/EC
UKCA mark (UK only)	The Supply of Machinery (Safety) Regulations 2008
Manufacturer address	Miele & Cie. KG, Carl-Miele-Straße 29, 33332 Gütersloh, Germany

\* If installed above 1,500 m, the boiling point of the wash water will be lower. In this case, the disinfecting temperature and the holding time might need to be adjusted.

## General programmes

Programme	Application
Mini	<p>Very short programme for very lightly soiled load items and very low final rinse requirements:</p> <ul style="list-style-type: none"> <li>- To remove water-soluble stains</li> <li>- Suitable to a limited extent for organic stains</li> <li>- Not suitable for denatured residues such as protein</li> <li>- Not suitable for inorganic, acid-soluble residues such as metallic salts</li> </ul>
Standard	<p>Short programme for lightly soiled load items and low final rinse requirements:</p> <ul style="list-style-type: none"> <li>- To remove water-soluble stains</li> <li>- Suitable to a limited extent for some stains</li> <li>- Not suitable for denatured residues such as protein</li> <li>- Not suitable for inorganic, acid-soluble residues such as metallic salts</li> </ul>
Universal	<p>Programme for lightly soiled to moderately soiled load items and moderate final rinse requirements:</p> <ul style="list-style-type: none"> <li>- To remove water-soluble stains</li> <li>- To remove organic stains</li> <li>- To remove denatured residues such as protein</li> <li>- Suitable to a limited extent for inorganic, acid-soluble residues, such as metallic salts</li> </ul>
Intensive	<p>Programme for moderately soiled to heavily soiled load items and moderate to high final rinse requirements:</p> <ul style="list-style-type: none"> <li>- To remove water-soluble stains</li> <li>- To remove organic stains</li> <li>- To remove denatured residues such as protein</li> <li>- Suitable to a limited extent for inorganic, acid-soluble residues, such as metallic salts</li> </ul>
Injector plus	<p>Programme with increased wash pressure and increased water levels for the following basket combinations:</p> <ul style="list-style-type: none"> <li>- Upper basket with one spray arm and lower basket with 2 injector modules</li> <li>- Upper and lower baskets with a total of 4 injector modules</li> </ul> <p>Use as described for the Universal programme.</p>

## Programme chart

---

### Programmes for specific soiling

Programme	Application
Inorganic	Programme for lightly soiled to moderately soiled load items and moderate to high final rinse requirements: <ul style="list-style-type: none"><li>- To remove inorganic, acid-soluble residues such as metallic salts</li></ul>
Organic	Programme for moderately soiled to heavily soiled load items and moderate final rinse requirements: <ul style="list-style-type: none"><li>- To remove concentrated organic residues, e.g. fats, waxes and stubborn dried-on or thermally-adhered organic residues</li><li>- Not suitable for inorganic, acid-soluble residues such as metallic salts</li></ul>
Oil programme	Programme for heavily soiled load items and moderate final rinse requirements: <ul style="list-style-type: none"><li>- To remove oil stains (e.g. synthetic oils, lubricants, fuels and some natural oils), fats and some waxes</li><li>- Not suitable for inorganic, acid-soluble residues such as metallic salts</li><li>- <b>Liquid cleaning agent required</b></li><li>- <b>Hot water connection</b> and DI water connection recommended</li></ul>

### Programmes for specific load items

Programme	Application
Plastics	Programme for lightly soiled to moderately soiled load items and moderate final rinse requirements <ul style="list-style-type: none"><li>- For temperature-sensitive laboratory equipment, e.g. plastic bottles</li><li>- <b>Temperature resistance up to minimum 55 °C</b> required</li></ul>
Pipettes	Programme for lightly soiled to moderately soiled pipettes and moderate to high final rinse requirements <ul style="list-style-type: none"><li>- For measuring and bulb pipettes</li></ul>

## Additional programmes

Programme	Application
Special 93°C-10'	Programme for cleaning and thermal disinfection at 93 °C with 10 minutes' temperature holding time. The wash water is not pumped away until after disinfection is complete.
Demineralised rinse	Programme for rinsing the wash cabinet and for rinsing load items with demineralised water (DI water), holding time: 3 Min.
Rinsing	Programme for rinsing the wash cabinet, for flushing out saline solution (see "Water softener/Adding salt") or for rinsing heavily soiled load items, e.g. for pre-rinsing soiling, residual disinfecting agent or to prevent items drying out and to prevent incrustation before running a full load. Cold water is used for rinsing, holding time: 1 Min
Drain	To drain away wash water, e.g. after a programme has been cancelled (see "Operation/Cancelling a programme").

## Programme selection depending on the accessories used

Upper basket		Lower basket		Water volume	Programme
Carrier with spray arm for various inserts	2 injector modules	Carrier for various inserts	2 injector modules		
✓		✓			Universal Standard Intensive Inorganic Organic Plastics Mini Oil programme
	✓	✓			
	✓				
			✓		
✓			✓	+ 2.0 to 2.5 l	Injector plus
	✓		✓		
			A 303 (+ 1 module)		Pipettes

# Programme parameters

## Free memory

New programme name:

<b>Programme header</b>	
▶ Change volume of water [l] _____ Drain time ▶ <input type="checkbox"/> Standard ▶ <input type="checkbox"/> Increased	Spray arm monitoring ▶ <input type="checkbox"/> On ▶ <input type="checkbox"/> Off for basket ▶ <input type="checkbox"/> Off
LFMmC max. value (option) Water intake ▶ Set [ $\mu$ S/cm] ▶ Number of repeats	Water drainage ▶ Set [ $\mu$ S/cm] ▶ Number of repeats
<input type="checkbox"/> 0 / <input type="checkbox"/> 1	<input type="checkbox"/> 0 / <input type="checkbox"/> 1

Parameter	Wash block			Pre-wash			Cleaning			Interim rinse			Final rinse		
	1	2	3	1	2	3	1	2	3	1	2	3	4	1	2
Water quality															
Dispensing system ▶ Concentration [%]															
Dispensing system ▶ Concentration [%]															
▶ Wash block temperature															
▶ Holding time [Min]															
▶ Monitor LFMmC (conductivity)															

<b>Drying unit</b>	
Cooling down pause ▶ <input type="checkbox"/> No ▶ Set [seconds]	Temperature 1 ▶ Drying time 1 [Min] ▶ Temperature 2 Drying time 2 ▶ Set [Min] ▶ Time changeable?
<input type="checkbox"/> Yes / <input type="checkbox"/> No	Cooling down with fan ▶ <input type="checkbox"/> No ▶ Set [seconds]
Automatic door opening ▶ <input type="checkbox"/> No / <input type="checkbox"/> Programme end	

- ▶ = Customisable parameters
- CW = cold water
- HW = hot water
- CWxx = CW proportion in mixed water as percentage (CW70 = 70 % CW + 30 % HW)
- DI = aqua destillata, fully demineralised water (DI), demineralised water

- Min = Holding time in minutes
- DOS 1 = cleaning agent
- DOS 3 = neutralising agent
- DOS 4 = DOS module

# Free memory

New programme name:

<b>Programme header</b>	
▶ Change volume of water [l] _____ Drain time ▶ <input type="checkbox"/> Standard ▶ <input type="checkbox"/> Increased	Spray arm monitoring ▶ <input type="checkbox"/> On ▶ <input type="checkbox"/> Off for basket ▶ <input type="checkbox"/> Off
LFMmc max. value (option) Water intake ▶ Set [ $\mu$ S/cm] ▶ Number of repeats _____	Water drainage ▶ Set [ $\mu$ S/cm] ▶ Number of repeats _____

Parameter	Wash block			Pre-wash			Cleaning			Interim rinse			Final rinse			
	1	2	3	1	2	3	1	2	3	1	2	3	4	1	2	
Water quality																
Dispensing system ▶ Concentration [%]																
Dispensing system ▶ Concentration [%]																
▶ Wash block temperature																
▶ Holding time [Min]																
▶ Monitor LFMmc (conductivity)																

<b>Drying unit</b>	
Cooling down pause ▶ <input type="checkbox"/> No ▶ Set [seconds] _____	Temperature 1 _____ Drying time 1 [Min] _____ Temperature 2 _____ Drying time 2 _____ ▶ Set [Min] _____ ▶ Time changeable? <input type="checkbox"/> Yes / <input type="checkbox"/> No
▶ <input type="checkbox"/> No ▶ Set [seconds] _____	Cooling down with fan ▶ <input type="checkbox"/> No ▶ Set [seconds] _____
	Automatic door opening ▶ <input type="checkbox"/> No / <input type="checkbox"/> Programme end

▶ = Customisable parameters  
 CW = cold water  
 HW = hot water  
 CWxx = CW proportion in mixed water as percentage (CW70 = 70 % CW + 30 % HW)  
 DI = aqua destillata, fully demineralised water (DI), demineralised water

Min = Holding time in minutes  
 DOS 1 = cleaning agent  
 DOS 3 = neutralising agent  
 DOS 4 = DOS module

# Programme parameters

## Mini

**Programme header**

Change volume of water [l] \_\_\_\_\_ Spray arm monitoring  On  Off for basket  Off  Off

Drain time  Standard  Increased

LFMMc max. value (option) \_\_\_\_\_

Water intake  Set [ $\mu$ S/cm] \_\_\_\_\_

Water drainage  Set [ $\mu$ S/cm] \_\_\_\_\_

Number of repeats  0 /  1

Number of repeats  0 /  1

Parameter	Wash block			Pre-wash			Cleaning			Interim rinse			Final rinse			
	1	2	3	1	2	3	1	2	3	1	2	3	4	1	2	
Water quality							HW			HW						DI
Dispensing system							DOS 1			DOS 3						
▶ Concentration [%]							0.3			0.1						
Dispensing system																
▶ Concentration [%]																
Wash block temperature							60 °C									60 °C
Holding time [Min]							3			2						1
Monitor LFMMc (conductivity)																On

**Drying unit**

Cooling down pause

▶ Temperature 1 \_\_\_\_\_

▶ Drying time 1 [Min] \_\_\_\_\_

▶ Temperature 2 \_\_\_\_\_

▶ Set [seconds] 110 °C

Cooling down with fan  No  Yes

▶ Set [seconds] 120

Automatic door opening  No /  Programme end

▶ Temperature 2 \_\_\_\_\_

Drying time 2 \_\_\_\_\_

▶ Set [Min] 30

▶ Time changeable?  Yes /  No

- ▶ Customisable parameters
  - CW = cold water
  - HW = hot water
  - CWxx = CW proportion in mixed water as percentage (CW70 = 70 % CW + 30 % HW)
  - DI = aqua destillata, fully demineralised water (DI), demineralised water
- ▶ Min = Holding time in minutes
- DOS 1 = cleaning agent
- DOS 3 = neutralising agent
- DOS 4 = DOS module



# Standard

**Programme header**

► Change volume of water [l] \_\_\_\_\_ Spray arm monitoring  
 ►  On  
 ►  Standard  
 ►  Increased

LFMMc max. value (option)  
 Water intake  
 ► Set [ $\mu$ S/cm] \_\_\_\_\_  
 ► Number of repeats  0 /  1

Water drainage  
 ► Set [ $\mu$ S/cm] \_\_\_\_\_  
 ► Number of repeats  0 /  1

Parameter	Wash block			Pre-wash			Cleaning			Interim rinse			Final rinse		
	1	2	3	1	2	3	1	2	3	1	2	3	4	1	2
Water quality															
Dispensing system															
	► Concentration [%]														
Dispensing system															
	► Concentration [%]														
► Wash block temperature															
► Holding time [Min]															
► Monitor LFMMc (conductivity)															

**Drying unit**

► Temperature 1 \_\_\_\_\_ Cooling down with fan  
 ► Drying time 1 [Min] \_\_\_\_\_ ►  No  
 ► Temperature 2 \_\_\_\_\_ ► Set [seconds] \_\_\_\_\_  
 30 110 °C 120

Drying time 2 \_\_\_\_\_  
 ► Set [Min] 30  
 ► Time changeable?  Yes /  No

Automatic door opening  
 ►  No /  Programme end

- = Customisable parameters
- CW = cold water
- HW = hot water
- CWxxx = CW proportion in mixed water as percentage (CW70 = 70 % CW + 30 % HW)
- DI = aqua destillata, fully demineralised water (DI), demineralised water
- Min = Holding time in minutes
- DOS 1 = cleaning agent
- DOS 3 = neutralising agent
- DOS 4 = DOS module

# Programme parameters

## Universal

**Programme header**

▶ Change volume of water [l] \_\_\_\_\_ Spray arm monitoring  
 ▶  On  
 ▶  Standard ▶ Off for basket  
 ▶  Increased ▶  Off

LFMmc max. value (option) \_\_\_\_\_  
 Water intake  
 ▶ Set [ $\mu$ S/cm] \_\_\_\_\_  
 ▶ Number of repeats  0 /  1

Water drainage  
 ▶ Set [ $\mu$ S/cm] \_\_\_\_\_  
 ▶ Number of repeats  0 /  1

Parameter	Wash block		Pre-wash		Cleaning		Interim rinse		Final rinse		
	1	2	3	1	2	1	2	3	4	1	2
Water quality	CW50			HW	HW	HW	HW	DI		DI	
Dispensing system				DOS 1	DOS 3						
▶ Concentration [%]				0.3	0.1						
Dispensing system											
▶ Concentration [%]											
Wash block temperature				75 °C						75 °C	
Holding time [Min]	1			3	2		1	1		1	
Monitor LFMmc (conductivity)											On

**Drying unit**

Cooling down pause  
 ▶  No  
 ▶ Set [seconds] 30

▶ Temperature 1 \_\_\_\_\_  
 ▶ Drying time 1 [Min] \_\_\_\_\_  
 ▶ Temperature 2 110 °C  
 Drying time 2 \_\_\_\_\_  
 ▶ Set [Min] 30  
 ▶ Time changeable?  Yes /  No

Cooling down with fan  
 ▶  No  
 ▶ Set [seconds] 120

Automatic door opening  
 ▶  No /  Programme end

- ▶ = Customisable parameters
- CW = cold water  
 HW = hot water  
 CWxx = CW proportion in mixed water as percentage (CW70 = 70 % CW + 30 % HW)  
 DI = aqua destillata, fully demineralised water (DI), demineralised water
- Min = Holding time in minutes  
 DOS 1 = cleaning agent  
 DOS 3 = neutralising agent  
 DOS 4 = DOS module

# Intensive

**Programme header**

► Change volume of water [l] \_\_\_\_\_ Spray arm monitoring  
 ►  On  
 ►  Standard  
 ►  Increased

LFMMc max. value (option)  
 Water intake  
 ► Set [ $\mu$ S/cm] \_\_\_\_\_  
 ► Number of repeats  0 /  1

Water drainage  
 ► Set [ $\mu$ S/cm] \_\_\_\_\_  
 ► Number of repeats  0 /  1

Parameter	Wash block			Pre-wash			Cleaning			Interim rinse			Final rinse		
	1	2	3	1	2	3	1	2	3	1	2	3	4	1	2
Water quality	CW50			HW			HW	DI	DI	DI	DI	DI		DI	
Dispensing system				DOS 1			DOS 3								
	► Concentration [%]			0.4			0.1								
Dispensing system															
► Concentration [%]															
► Wash block temperature				80 °C										75 °C	
► Holding time [Min]	1			3			2	1	1					1	
► Monitor LFMMc (conductivity)														On	

**Drying unit**

Cooling down pause  
 ►  No  
 ► Set [seconds] 30

► Temperature 1 \_\_\_\_\_  
 ► Drying time 1 [Min] \_\_\_\_\_  
 ► Temperature 2 110 °C  
 Drying time 2 \_\_\_\_\_  
 ► Set [Min] 30  
 ► Time changeable?  Yes /  No

Cooling down with fan  
 ►  No  
 ► Set [seconds] 120

Automatic door opening  
 ►  No /  Programme end

- = Customisable parameters
- CW = cold water
- HW = hot water
- CWxxx = CW proportion in mixed water as percentage (CW70 = 70 % CW + 30 % HW)
- DI = aqua destillata, fully demineralised water (DI), demineralised water
- Min = Holding time in minutes
- DOS 1 = cleaning agent
- DOS 3 = neutralising agent
- DOS 4 = DOS module

# Programme parameters

## Injector plus

**Programme header**

▶ Change volume of water [l] \_\_\_\_\_ Spray arm monitoring  
 ▶  On  
 ▶  Standard ▶ Off for basket  
 ▶  Increased ▶  Off

LFMmc max. value (option) \_\_\_\_\_  
 Water intake  
 ▶ Set [ $\mu$ S/cm] \_\_\_\_\_  
 ▶ Number of repeats  0 /  1

Water drainage  
 ▶ Set [ $\mu$ S/cm] \_\_\_\_\_  
 ▶ Number of repeats  0 /  1

Parameter	Wash block		Pre-wash		Cleaning		Interim rinse		Final rinse		
	1	2	3	1	2	1	2	3	4	1	2
Water quality	CW50			HW	HW	HW	HW	DI		DI	
Dispensing system				DOS 1	DOS 3						
▶ Concentration [%]				0.3	0.1						
Dispensing system											
▶ Concentration [%]											
Wash block temperature				75 °C						75 °C	
Holding time [Min]	1			3	2		1	1		1	
Monitor LFMmc (conductivity)											On

**Drying unit**

Cooling down pause  
 ▶  No  
 ▶ Set [seconds] 30

▶ Temperature 1 \_\_\_\_\_  
 ▶ Drying time 1 [Min] \_\_\_\_\_  
 ▶ Temperature 2 110 °C  
 Drying time 2 \_\_\_\_\_  
 ▶ Set [Min] 30  
 ▶ Time changeable?  Yes /  No

Cooling down with fan  
 ▶  No  
 ▶ Set [seconds] 120

Automatic door opening  
 ▶  No /  Programme end

- ▶ = Customisable parameters
- CW = cold water  
 HW = hot water  
 CWxx = CW proportion in mixed water as percentage (CW70 = 70 % CW + 30 % HW)  
 DI = aqua destillata, fully demineralised water (DI), demineralised water
- Min = Holding time in minutes  
 DOS 1 = cleaning agent  
 DOS 3 = neutralising agent  
 DOS 4 = DOS module

# Inorganic

**Programme header**

► Change volume of water [l] \_\_\_\_\_ Spray arm monitoring  
 ►  On  
 ►  Standard  
 ►  Increased

LFMMc max. value (option)  
 Water intake  
 ► Set [ $\mu$ S/cm] \_\_\_\_\_  
 ► Number of repeats  0 /  1

Water drainage  
 ► Set [ $\mu$ S/cm] \_\_\_\_\_  
 ► Number of repeats  0 /  1

Parameter	Wash block			Pre-wash			Cleaning			Interim rinse			Final rinse		
	1	2	3	1	2	3	1	2	3	1	2	3	4	1	2
Water quality															
Dispensing system															
	► Concentration [%]						DOS 3	DOS 1	DOS 3	DOS 3	DOS 1	DOS 3	DOS 3		
Dispensing system															
	► Concentration [%]						0.3	0.4	0.1	0.3	0.4	0.1	0.1		
► Wash block temperature							50 °C	75 °C						70 °C	
► Holding time [Min]							2	3	2	2	1	1	1	1	
► Monitor LFMMc (conductivity)														On	

**Drying unit**

Cooling down pause  
 ►  No  
 ► Set [seconds] 30

► Temperature 1 \_\_\_\_\_  
 ► Drying time 1 [Min] \_\_\_\_\_  
 ► Temperature 2 110 °C  
 Drying time 2 \_\_\_\_\_  
 ► Set [Min] 30  
 ► Time changeable?  Yes /  No

Cooling down with fan  
 ►  No  
 ► Set [seconds] 120

Automatic door opening  
 ►  No /  Programme end

- = Customisable parameters
- CW = cold water
- HW = hot water
- CWxxx = CW proportion in mixed water as percentage (CW70 = 70 % CW + 30 % HW)
- DI = aqua destillata, fully demineralised water (DI), demineralised water
- Min = Holding time in minutes
- DOS 1 = cleaning agent
- DOS 3 = neutralising agent
- DOS 4 = DOS module

# Programme parameters

## Organic

**Programme header**

Change volume of water [l] \_\_\_\_\_ Spray arm monitoring  On  Off for basket  Off

Drain time  Standard  Increased

LFMMc max. value (option) \_\_\_\_\_

Water intake  Set [ $\mu$ S/cm] \_\_\_\_\_

Water drainage  Set [ $\mu$ S/cm] \_\_\_\_\_

Number of repeats  0 /  1

Number of repeats  0 /  1

Parameter	Wash block			Pre-wash			Cleaning			Interim rinse			Final rinse		
	1	2	3	1	2	3	1	2	3	1	2	3	4	1	2
Water quality							HW	HW	HW	HW	HW	DI		DI	
Dispensing system				DOS 1	DOS 1	DOS 3	DOS 1	DOS 1	DOS 3						
▶ Concentration [%]				0.4	0.3	0.1									
Dispensing system															
▶ Concentration [%]															
Wash block temperature				65 °C	85 °C									75 °C	
Holding time [Min]				3	3	2				1	1			1	
Monitor LFMMc (conductivity)														On	

**Drying unit**

Cooling down pause  No  Yes

▶ Temperature 1 \_\_\_\_\_

▶ Drying time 1 [Min] \_\_\_\_\_

▶ Temperature 2 \_\_\_\_\_

▶ Set [seconds] 30

Cooling down with fan  No  Yes

▶ Set [seconds] 120

Drying time 2 \_\_\_\_\_

▶ Set [Min] 30

▶ Time changeable?  Yes /  No

Automatic door opening  No /  Programme end

- ▶ = Customisable parameters
- CW = cold water
- HW = hot water
- CWxx = CW proportion in mixed water as percentage (CW70 = 70 % CW + 30 % HW)
- DI = aqua destillata, fully demineralised water (DI), demineralised water
- Min = Holding time in minutes
- DOS 1 = cleaning agent
- DOS 3 = neutralising agent
- DOS 4 = DOS module

# Oil programme

**Programme header**

▶ Change volume of water [l] \_\_\_\_\_ Spray arm monitoring  On LFMmc max. value (option) \_\_\_\_\_  
 Drain time \_\_\_\_\_  
 ▶  Standard ▶  Off for basket Water intake \_\_\_\_\_  
 ▶  Increased ▶  Off ▶ Number of repeats \_\_\_\_\_ ▶ Set [ $\mu$ S/cm] \_\_\_\_\_  
 ▶ Number of repeats  0 /  1 ▶ Number of repeats  0 /  1

Parameter	Wash block			Pre-wash			Cleaning			Interim rinse			Final rinse		
	1	2	3	1	2	3	1	2	3	1	2	3	4	1	2
Water quality	HW			HW			HW	HW		HW	HW	DI		DI	
Dispensing system	DOS 4			DOS 4	DOS 1		DOS 4	DOS 1	DOS 3						
▶ Concentration [%]	0.5			0.4	0.3		0.4	0.3	0.1						
Dispensing system	DOS 1			DOS 1			DOS 1								
▶ Concentration [%]	0.3			0.4			0.4								
▶ Wash block temperature	45 °C			65 °C	85 °C		65 °C	85 °C						75 °C	
▶ Holding time [Min]	1			2	3		2	3	2	1	1			1	
▶ Monitor LFMmc (conductivity)														On	

**Drying unit**

▶ Temperature 1 \_\_\_\_\_ Cooling down with fan \_\_\_\_\_ Automatic door opening  No /  Programme end  
 ▶ Drying time 1 [Min] \_\_\_\_\_ ▶  No  
 ▶ Temperature 2 \_\_\_\_\_ 110 °C ▶ Set [seconds] \_\_\_\_\_ 120  
 Drying time 2 \_\_\_\_\_  
 ▶ Set [Min] \_\_\_\_\_ 30  
 ▶ Time changeable?  Yes /  No

- ▶ = Customisable parameters
- CW = cold water
- HW = hot water
- CWxx = CW proportion in mixed water as percentage (CW70 = 70 % CW + 30 % HW)
- DI = aqua destillata, fully demineralised water (DI), demineralised water
- Min = Holding time in minutes
- DOS 1 = cleaning agent
- DOS 3 = neutralising agent
- DOS 4 = DOS module

# Programme parameters

## Plastics

**Programme header**

Change volume of water [l] \_\_\_\_\_ Spray arm monitoring  On  Off for basket  Off

Drain time  Standard  Increased

LFMMc max. value (option) \_\_\_\_\_

Water intake  0 /  1

Water drainage  Set [ $\mu$ S/cm] \_\_\_\_\_

Number of repeats  0 /  1

Parameter	Wash block			Pre-wash			Cleaning			Interim rinse			Final rinse		
	1	2	3	1	2	3	1	2	3	1	2	3	4	1	2
Water quality	CW						CW			CW					
Dispensing system							DOS 1			DOS 3					
▶ Concentration [%]							0.3			0.1					
Dispensing system															
▶ Concentration [%]															
Wash block temperature							55 °C								
Holding time [Min]	1						3			2		1	1	1	
Monitor LFMMc (conductivity)															On

**Drying unit**

Cooling down pause

▶ Temperature 1 \_\_\_\_\_ 80 °C

▶ Drying time 1 [Min] \_\_\_\_\_ 30

▶ Temperature 2 \_\_\_\_\_ 70 °C

▶ Set [seconds] \_\_\_\_\_ 120

Automatic door opening  No /  Programme end

Drying time 2 \_\_\_\_\_

▶ Set [Min] \_\_\_\_\_ 15

▶ Time changeable?  Yes /  No

- ▶ Customisable parameters
  - Min = Holding time in minutes
  - DOS 1 = cleaning agent
  - DOS 3 = neutralising agent
  - DOS 4 = DOS module
- CW = cold water
- HW = hot water
- CWxx = CW proportion in mixed water as percentage (CW70 = 70 % CW + 30 % HW)
- DI = aqua destillata, fully demineralised water (DI), demineralised water



# Pipettes

**Programme header**

► Change volume of water [l] \_\_\_\_\_ Spray arm monitoring  
 ►  On  
 ►  Standard  
 ►  Increased

LFMMc max. value (option)  
 Water intake  
 ► Set [ $\mu$ S/cm] \_\_\_\_\_  
 ► Number of repeats  0 /  1

Water drainage  
 ► Set [ $\mu$ S/cm] \_\_\_\_\_  
 ► Number of repeats  0 /  1

Parameter	Wash block			Pre-wash			Cleaning			Interim rinse			Final rinse		
	1	2	3	1	2	3	1	2	3	1	2	3	4	1	2
Water quality	CW50			HW			HW	DI	DI	DI	DI	DI		DI	
Dispensing system				DOS 1			DOS 3								
	► Concentration [%]			0.4			0.1								
Dispensing system															
	► Concentration [%]														
► Wash block temperature				70 °C										70 °C	
► Holding time [Min]	1			3			2	1	1					1	
► Monitor LFMMc (conductivity)														On	

**Drying unit**

Cooling down pause  
 ►  No  
 ► Set [seconds] 30 \_\_\_\_\_

► Temperature 1 \_\_\_\_\_  
 ► Drying time 1 [Min] \_\_\_\_\_  
 ► Temperature 2 80 °C \_\_\_\_\_  
 Drying time 2 \_\_\_\_\_  
 ► Set [Min] 35 \_\_\_\_\_  
 ► Time changeable?  Yes /  No

Cooling down with fan  
 ►  No  
 ► Set [seconds] 120 \_\_\_\_\_

Automatic door opening  
 ►  No /  Programme end

- = Customisable parameters
- CW = cold water
- HW = hot water
- CWxx = CW proportion in mixed water as percentage (CW70 = 70 % CW + 30 % HW)
- DI = aqua destillata, fully demineralised water (DI), demineralised water
- Min = Holding time in minutes
- DOS 1 = cleaning agent
- DOS 3 = neutralising agent
- DOS 4 = DOS module

# Programme parameters

## Special 93°C-10'

**Programme header**

Change volume of water [l] \_\_\_\_\_ Spray arm monitoring  On

Drain time  Standard  Off for basket

Increased  Off

LFMMc max. value (option) \_\_\_\_\_

Water intake  Set [ $\mu$ S/cm] \_\_\_\_\_

Water drainage  Set [ $\mu$ S/cm] \_\_\_\_\_

Number of repeats  0 /  1

Number of repeats  0 /  1

Parameter	Wash block			Pre-wash			Cleaning			Interim rinse			Final rinse		
	1	2	3	1	2	3	1	2	3	1	2	3	4	1	2
Water quality															
Dispensing system															
	Concentration [%]														
Dispensing system															
	Concentration [%]														
Wash block temperature															
Holding time [Min]															
Monitor LFMMc (conductivity)															

**Drying unit**

Cooling down pause  No  Yes

Temperature 1 100 °C

Drying time 1 [Min] 20

Temperature 2 95 °C

30

Drying time 2 \_\_\_\_\_

Set [Min] 50

Time changeable?  Yes /  No

Cooling down with fan  No  Yes

Automatic door opening  No /  Programme end

Set [seconds] 120

- Min = Holding time in minutes
- DOS 1 = cleaning agent
- DOS 3 = neutralising agent
- DOS 4 = DOS module
- CW = cold water
- HW = hot water
- CWxx = CW proportion in mixed water as percentage (CW70 = 70 % CW + 30 % HW)
- DI = aqua destillata, fully demineralised water (DI), demineralised water

### Disposal of the packing material

The packaging is designed to protect the machine against transportation damage. The packaging materials used are selected from materials which are environmentally friendly for disposal and should be recycled.

Recycling the packaging reduces the use of raw materials in the manufacturing process and also reduces the amount of waste in landfill sites.

### Disposing of your old appliance

Electrical and electronic appliances contain many valuable materials. They also contain certain materials, compounds and components which were essential for their correct functioning and safety. These could be hazardous to human health and to the environment if disposed of with household waste or if handled incorrectly. Please do not, therefore, dispose of your old appliance with household waste.

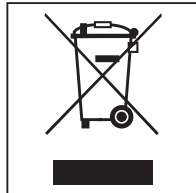

Instead, please make use of officially designated collection and disposal points to dispose of and recycle electrical and electronic appliances in your local community, with your dealer or with Miele, free of charge. By law, you are solely responsible for deleting any personal data from the old appliance prior to disposal. You are legally obliged to remove any old batteries which are not securely enclosed by the appliance and to remove any lamps without destroying them, where this is possible. These must be taken to a suitable collection point where they can be handed in free of charge. Please ensure that your old appliance poses no risk to children while being stored for disposal.

Australia and New Zealand:

Please dispose of it at your local community waste collection / recycling centre for electrical and electronic appliances. You are also responsible for deleting any personal data that may be stored on the appliance prior to disposal. Please ensure that your old appliance poses no risk to children while being stored prior to disposal.

## United Kingdom

Miele Co. Ltd., Fairacres, Marcham Road  
Abingdon, Oxon, OX14 1TW  
Professional Sales, Tel: 0845 365 6608  
E-mail: professional@miele.co.uk  
Internet: www.miele.co.uk/professional

## Australia

Miele Australia Pty. Ltd.  
ACN 005 635 398, ABN 96 005 635 398  
Level 4, 141 Camberwell Road, Hawthorn East, VIC 3123  
Tel: 1300 731 411  
Internet: www.miele.com.au/professional  
E-mail: sales@miele-professional.com.au

## China Mainland

Miele Electrical Appliances Co., Ltd.  
1-3 Floor, No. 82 Shi Men Yi Road  
Jing' an District, 200040 Shanghai, PRC  
Tel: +86 21 6157 3500, Fax: +86 21 6157 3511  
E-mail: info@miele.cn, Internet: www.miele.cn

## Hong Kong, China

Miele (Hong Kong) Ltd.  
41/F - 4101, Manhattan Place  
23 Wang Tai Road, Kowloon Bay, Hong Kong  
Tel: (852) 2610 1025, Fax: (852) 3579 1404  
Email: customerservices@miele.com.hk  
Website: www.miele.hk

## India

Miele India Pvt. Ltd.  
1st Floor, Copia Corporate Suites,  
Commercial Plot 9, Mathura Road, Jasola,  
New Delhi - 110025  
E-mail: customercare@miele.in, Website: www.miele.in

## Ireland

Miele Ireland Ltd.  
2024 Bianconi Ave., Citywest Business Campus, Dublin 24  
Tel: (01) 461 07 10, Fax: (01) 461 07 97  
E-Mail: info@miele.ie, Internet: www.miele.ie

## Malaysia

Miele Sdn Bhd  
Suite 12-2, Level 12  
Menara Sapura Kencana Petroleum  
Solaris Dutamas No. 1, Jalan Dutamas 1  
50480 Kuala Lumpur, Malaysia  
Phone: +603-6209-0288  
Fax: +603-6205-3768

## New Zealand

Miele New Zealand Limited  
IRD 98 463 631  
8 College Hill  
Freemans Bay, Auckland 1011, NZ  
Tel: 0800 464 353  
Internet: www.miele.com.au/professional  
E-mail: sales@miele-professional.com.au

## Singapore

Miele Pte. Ltd.  
29 Media Circle, #11-04 ALICE@Mediapolis  
Singapore 138565  
Tel: +65 6735 1191, Fax: +65 6735 1161  
E-Mail: info@miele.com.sg  
Internet: www.miele.sg

## South Africa

Miele (Pty) Ltd  
63 Peter Place, Bryanston 2194  
P.O. Box 69434, Bryanston 2021  
Tel: (011) 875 9000, Fax: (011) 875 9035  
E-mail: info@miele.co.za  
Internet: www.miele.co.za

## United Arab Emirates

Miele Appliances Ltd.  
Showroom 1, Eiffel 1 Building  
Sheikh Zayed Road, Umm Al Sheif  
P.O. Box 114782 - Dubai  
Tel. +971 4 3044 999, Fax. +971 4 3418 852  
800-MIELE (64353)  
E-Mail: info@miele.ae, Website: www.miele.ae



Manufacturer: Miele & Cie. KG  
Carl-Miele-Straße 29, 33332 Gütersloh, Germany