



## Operating instructions Bottom-mount units







To prevent accidents and damage to the range, you **must** read all instructions supplied before installing or using the appliance.

# Contents

---

<b>IMPORTANT SAFETY INSTRUCTIONS</b> .....	<b>4</b>	Switching on the appliance .....	33
<b>Sustainability and environmental protection</b> .....	<b>13</b>	Switching off the appliance .....	33
How to save energy .....	14	Turning off the refrigerator section separately .....	33
<b>Installation</b> .....	<b>15</b>	Switching off for longer periods of time .....	34
Installation site .....	15	Setting up networking for the first time.....	34
Ventilation requirements .....	16	Performing Scan & Connect.....	35
Installing several refrigeration appliances next to one another .....	17	<b>Operation</b> .....	<b>36</b>
Door hinge change .....	17	The correct temperature .....	36
Ordering printed installation instructions .....	17	Temperature display.....	36
Installing the refrigeration appliance .....	18	Setting the temperature in the refrigerator/freezer sections .....	36
Aligning the refrigeration appliance .....	18	Temperature and door alarm .....	37
Integrating the refrigeration appliance in a run of kitchen cabinets.....	19	Door alarm.....	38
Appliance dimensions.....	21	Using Automatic SuperCool, SuperFrost, and DynaCool .....	38
Electrical connection .....	23	Storing food in the fridge zone .....	40
<b>Guide to the appliance</b> .....	<b>25</b>	Different storage zones .....	40
Appliance overview .....	25	Should food be stored loose or in packaging? .....	41
Control panel with status display....	27	Storing food in the DailyFresh drawer .....	42
Settings mode  .....	27	Freezing and storing fresh food.....	43
Selecting the desired function in Settings mode  .....	29	Cooling drinks quickly .....	43
Adjusting the interior fittings .....	30		
Moving the door shelf/bottle shelf .....	30		
Moving the adjustable shelves ..	30		
Sliding back the split shelf.....	30		
Moving the split shelf.....	30		
Space for a baking tray.....	30		
Moving the Active AirClean filter .....	31		
Flexible configuration of the freezer zone (VarioRoom) .....	31		
Accessories supplied .....	32		
Optional accessories .....	32		
<b>Switching on and off</b> .....	<b>33</b>		
Before using for the first time .....	33		
Connecting the appliance.....	33		

<b>Selecting additional settings</b> .....	<b>45</b>	<b>Customer Service</b> .....	<b>68</b>
Explanation of the different settings .....	45	Contact in the event of a fault.....	68
Party mode  .....	45	Appliance warranty and product registration .....	68
Vacation mode  .....	45	<b>Information</b> .....	<b>69</b>
Switching the safety-lock function  /  on .....	45	Copyrights and licenses .....	69
Sabbath mode  .....	46		
Changing the time before the door alarm  is triggered.....	47		
Networking .....	47		
Changing the volume of the alarms and audible signals  /  .....	49		
Adjusting the display brightness  .....	49		
Switching off Demo mode  .....	49		
Resetting the settings to their factory default settings  .....	50		
Information  .....	50		
Carbon-filter change indicator  .....	50		
Cleaning mode  .....	50		
<b>Cleaning and care</b> .....	<b>51</b>		
Defrosting .....	51		
Cleaning agents .....	51		
Preparing the refrigeration appliance for cleaning.....	52		
Cleaning the interior of the appliance .....	52		
Cleaning accessories by hand or in the dishwasher .....	53		
Removing, dismantling, and cleaning accessories .....	53		
Cleaning the machine front and the side panels.....	55		
Cleaning the door seal .....	56		
Cleaning the ventilation openings... ..	56		
After cleaning .....	56		
<b>Frequently asked questions</b> .....	<b>57</b>		
Interior lighting.....	65		
Causes of noises .....	66		

## IMPORTANT SAFETY INSTRUCTIONS

This refrigeration appliance complies with current safety requirements. Inappropriate use can, however, lead to personal injury and material damage.

Please read the operating and installation instructions carefully before using the refrigeration appliance for the first time. They contain important information on installation, safety, use, and maintenance. This will prevent both personal injury and damage to the refrigeration appliance.

Miele expressly and strongly advises that you read and follow the instructions in the chapter on installing the refrigeration appliance as well as in the "IMPORTANT SAFETY INSTRUCTIONS".

Miele cannot be held liable for injury or damage caused by non-compliance with these instructions.

Keep these operating and installation instructions in a safe place and pass them on to any future owner.

### Appropriate use

► This refrigeration appliance is intended for use in the home and in similar environments, for example:

- in shops, offices, and similar work settings
- on agricultural estates
- by the guests in hotels, motels, bed and breakfasts, and other typical home settings

This refrigeration appliance is not intended for outdoor use.

► This appliance is intended for domestic use only for cooling and storing food and drink as well as for storing deep frozen food, freezing fresh food and for making ice. Any other usage is not supported by the manufacturer and could be dangerous.

► This refrigeration appliance is not suitable for storing and keeping cool medicines, blood plasma, laboratory preparations, or other similar substances or products that are subject to the Medical Device Directive. Incorrect use of the refrigeration appliance for such purposes may cause deterioration of the items stored. The refrigeration appliance is also not suitable for use in areas where there is a risk of explosion.

Miele cannot be held liable for damage resulting from incorrect or improper use or operation.

# IMPORTANT SAFETY INSTRUCTIONS

▶ This refrigeration appliance may only be used by people (including children) with reduced physical, sensory, or mental capabilities or lack of experience and knowledge if they are supervised while using it.

## Safety with children

▶ Children must be kept away from the refrigeration appliance unless they are constantly supervised.

▶ Children may only use the appliance even without supervision if they have been shown how to use it in a safe manner, and if they are able to recognize and understand the potential risks of improper use.

▶ To reduce the risk of injury, do not allow children to play in, on or near the appliance.

▶ Risk of suffocation. While playing, children may become entangled in packaging material (such as plastic wrapping) or pull the packaging material over their head, presenting the risk of suffocation. Keep packaging material away from children.

## Technical safety

▶ The coolant circuit has been checked for leaks. The refrigeration appliance complies with statutory and regulatory requirements.



If the cooling circuit is damaged, refrigerant and oil can escape and ignite.

▶ Warning: fire hazard/flammable materials. This symbol is on the compressor and indicates flammable materials. Do not remove this sticker.

## IMPORTANT SAFETY INSTRUCTIONS

---

The refrigerant inside the appliance (details on the data plate) is environmentally friendly but flammable.

The use of this refrigerant does, however, sometimes lead to a slight increase in the noise level of the appliance. In addition to the noise of the compressor, you might be able to hear the refrigerant flowing around the cooling circuit. Unfortunately, this cannot be avoided, but it does not affect the performance of the refrigeration appliance.

When transporting and installing the refrigeration appliance, ensure that no parts of the cooling circuit are damaged. Splashes of refrigerant can damage the eyes and leaking refrigerant can ignite.

In the event of damage:

- Avoid open flames or anything which creates a spark.
- Disconnect the refrigeration appliance from the power supply.
- Ventilate the room where the refrigeration appliance is located for several minutes.
- Contact Miele Service.

▶ The more refrigerant there is in a refrigeration appliance, the larger the room it should be installed in. In the event of a leakage, if the appliance is in a small room, there is the danger of a combustible gas/air mixture building up. For every 8 g of refrigerant, at least 35.3 ft<sup>3</sup> (1 m<sup>3</sup>) of room space is required. The amount of refrigerant in the refrigeration appliance is stated on the data plate inside the appliance.

▶ If the ventilation openings are covered or blocked, a combustible gas/air mixture can form if the cooling circuit is damaged. It is essential to observe the required ventilation openings. The ventilation openings must never be obstructed.

▶ To avoid the risk of damage to the appliance, make sure that the connection data (fuse rating, frequency and voltage) on the data plate corresponds to the household supply.

Check that this is the case before connecting the appliance. Consult a qualified electrician if in any doubt.

▶ The electrical safety of the appliance can only be guaranteed when correctly grounded. It is essential that this standard safety requirement is met. If in any doubt please have the electrical installation tested by a qualified electrician.

## IMPORTANT SAFETY INSTRUCTIONS

---

▶ Temporary or permanent operation on an autonomous power supply system or a power supply system that is not synchronized with the grid power supply (e.g., island networks, back-up systems) is possible. A prerequisite for operation is that the power supply system complies with national and local codes.

The function and operation of the protective measures provided in the domestic electrical installation and in this Miele product must also be maintained in isolated operation or in operation that is not synchronized with the grid power supply, or these measures must be replaced by equivalent measures in the installation.

▶ The outlet must not be concealed behind the appliance and must be easily accessible so that the appliance can be quickly disconnected from the electrical supply in case of an emergency. If free access is not possible, an all-pole isolating switch must be integrated in the permanent electrical installation according to the installation regulations.

▶ If the power cord is damaged, disconnect the refrigeration appliance from the power supply immediately. Contact Miele Service.

▶ If the power cord is damaged, it must only be replaced with a specific power cord of the same type (available from Miele Service). For safety reasons, this replacement may only be carried out by a qualified specialist or Miele Service.

▶ Do not connect the appliance to the electrical supply with a power bar or extension cord. These are a fire hazard and do not guarantee the required safety of the appliance.

▶ If moisture gets into electrical components or into the power cord, it could cause a short circuit. Therefore, do not operate the machine in areas where there may be moisture or splashing water (e.g., garages, laundry rooms).

▶ This appliance must not be installed and operated in mobile installations (e.g. on a ship).

▶ Do not use a damaged appliance. It could be dangerous. Check the appliance for visible signs of damage.

▶ This refrigeration appliance is not intended for use as a built-in appliance.

▶ During installation, side-by-side heater installation, maintenance and repair work, the appliance must be disconnected from the electrical power supply. It is only completely isolated from the electricity supply when:

## IMPORTANT SAFETY INSTRUCTIONS

---

- the circuit breaker has been tripped, or
- the screw-type fuses on the electrical service panel have been removed or
- the power cord has been unplugged. Pull on the plug and not on the cord when removing it from the outlet.

▶ Unauthorized installation, maintenance, and repairs could result in unforeseen dangers for the user, for which the manufacturer cannot accept liability.

Installation, maintenance, and repairs should only be carried out by a qualified specialist or Miele Service.

▶ The manufacturer's warranty may be invalidated if the refrigeration appliance is not repaired by a qualified specialist or by Miele Service.

▶ We recommend replacing faulty components with original Miele parts. If original Miele parts are installed correctly, Miele ensures full compliance with safety requirements and the warranty remains valid.

▶ This refrigeration appliance is supplied with a special bulb to cope with particular conditions (e.g., temperature, moisture, chemical resistance, abrasion resistance, and vibration). This bulb must only be used for the purpose for which it is intended. The bulb is not suitable for room lighting. Replacement bulbs should only be installed by a qualified specialist or by Miele Service. This refrigeration appliance contains several light sources with at least energy efficiency class F.

### Proper installation

▶ When installing the refrigeration appliance, it is a mandatory requirement to follow the operating instructions supplied with the appliance.

▶ Change the door hinging (if necessary) as described in the installation instructions.

▶ Always wear protective gloves when transporting and setting up the refrigeration appliance and when changing the door hinging.

▶ The refrigeration appliance is heavy and can tip forward when the appliance door(s) is (are) open:

- At least 2 people are required to transport or move the refrigeration appliance.
- At least 2 people are required to change the door hinging of the refrigeration appliance.

## IMPORTANT SAFETY INSTRUCTIONS

---

- At least 2 people are required to install the refrigeration appliance.
- Never leave the refrigeration appliance unattended while it is being installed.

### Correct use

- ▶ This refrigeration appliance is designed for use within specific ambient temperatures (climate range). Do not use in ambient temperatures for which it is not designed. The climate range is stated on the data plate in the interior cabinet of the refrigeration appliance. A lower ambient temperature will cause the compressor to switch off for longer periods, meaning that the refrigeration appliance is unable to maintain the required temperature.
- ▶ The ventilation openings must never be obstructed. This can impair the proper ventilation of the appliance, increase the energy consumption and cause damage to the components.
- ▶ Risk of damage due to greasy or oily foods. If the refrigeration appliance or the appliance door is used for storing food which contains fat or oil, make sure that it does not come into contact with plastic components. Any spillages of oil or fat could cause stress cracks to the plastic and cause it to break or split.
- ▶ Risk of fire and explosion due to flammable mixes of gases. Do not store any explosive materials or products containing flammable propellants (e.g., spray cans) in the refrigeration appliance. Electrical components can cause flammable mixes of gases to ignite. The spray cans in question can be identified by the contents printed on the can or by a flame symbol. Electrical components can cause escaping gases to ignite.
- ▶ Risk of explosion. Do not operate any electrical equipment (e.g., an electric ice-cream maker) inside the refrigeration appliance. This can cause sparking and explosion.
- ▶ Risk of injury and damage. Do not store cans or bottles containing carbonated drinks or liquids which could freeze in the freezer section. Otherwise they could burst.
- ▶ Risk of injury and damage. When chilling drinks in the freezer section, make sure that bottles are not left in for more than one hour. Otherwise they could burst.
- ▶ Risk of injury. Never handle frozen food or the metal parts of the appliance with wet hands. Your hands may freeze to the frozen food or to the metal.

## IMPORTANT SAFETY INSTRUCTIONS

---

- ▶ Risk of injury. Do not take ice cubes out with your bare hands and never place ice cubes or ice pops in your mouth straight from the freezer section. The very low temperature of the frozen food can cause frost burn to the lips and tongue.
- ▶ Do not refreeze partially or fully defrosted food. Consume defrosted food as soon as possible, as it will lose its nutritional value and spoil if left for too long. Defrosted food may only be refrozen after it has been cooked.
- ▶ When eating stored food, there is a danger of food poisoning. Storage times will depend on several factors, including the freshness and quality of the food, as well as the temperature at which it is stored. Observe the manufacturer's "use-by" dates and storage instructions.
- ▶ To ensure that fresh food placed in the freezer freezes through to the core as quickly as possible, the maximum freezing capacity must not be exceeded. The maximum freezing capacity for freezing within a 24-hour period is given on the data plate: "Freezing capacity ... lbs/24 hrs".

### **Stainless steel machines:**

- ▶ Adhesives will damage the coated stainless steel surface and cause it to lose its dirt-repellent protective coating. Do not use sticky notes, transparent adhesive tape, masking tape, or other types of adhesive on the stainless steel surface.
- ▶ The surface is easily scratched. Even magnets can cause scratching.

### **Accessories and parts**

- ▶ We recommend using original Miele accessories. Using parts or accessories from other manufacturers may invalidate the warranty, and Miele cannot accept liability.

### **Cleaning and maintenance**

- ▶ Do not use any oil or grease on the door seals. They can cause the seals to deteriorate over time.
- ▶ Never use a steam cleaner to clean the appliance. The steam can reach the electrical components and cause a short circuit.
- ▶ **WARNING! DANGER of injury and damage!** Do not use any mechanical tools or other types of aid which are not recommended by the manufacturer to accelerate the defrosting process.

## IMPORTANT SAFETY INSTRUCTIONS

---

▶ Sharp edged or pointed objects will damage the evaporator, causing irreversible damage to the appliance. Do not use sharp edged or pointed objects to

- remove frost or ice,
- separate frozen foods or remove ice trays.

▶ Never place electric heaters or candles in the appliance to defrost it. These can damage the plastic parts.

▶ Do not use defrosting sprays or de-icers. Defrosting sprays and de-icers can contain substances which could damage the plastic parts or which might cause a build-up of explosive gases and pose a danger to health.

### **Transport**

▶ To avoid damage to the refrigeration appliance, always transport it upright and in its packaging.

▶ Risk of injury and damage. The refrigeration appliance is very heavy and must be transported by two people.

### **Disposal of your old appliance**

▶ **DANGER!** Risk of child entrapment! Children could become trapped in the refrigeration appliance and could suffocate.

- Remove the appliance door(s).
- Remove the drawers.
- Leave the adjustable shelves in the refrigeration appliance so children cannot climb inside.
- If your old refrigeration appliance has a door lock, destroy it. This will prevent the risk of children playing accidentally locking themselves in and endangering their lives.

▶ Risk of electric shock!

- Cut the electrical plug off the power cord.
- Cut the power cord off the old appliance.

Dispose of the electrical plug and power cord separately from the old appliance.

▶ Ensure that the appliance is not stored in the vicinity of gasoline or inflammable gases and liquids during and after disposal.

# IMPORTANT SAFETY INSTRUCTIONS

▶ Risk of fire due to escaping oil or refrigerant.

The refrigerant and oil inside the appliance are flammable. In high enough concentrations, escaping refrigerant or oil can ignite if they come into contact with an external heat source.

During disposal, make sure that the cooling circuit is not damaged. This prevents refrigerant and oil escaping in an uncontrolled manner (see the data plate for details of the refrigerant).

▶ If your old refrigeration appliance has a door lock, destroy it. This will prevent the risk of children playing accidentally locking themselves in and endangering their lives.

▶ Splashes of coolant can cause damage to the eyes. Be careful not to damage any part of the pipework while awaiting disposal, e.g. by

- puncturing the coolant channels in the evaporator,
- kinking any pipework,
- scratching the surface coating.

## Symbol on the compressor (depending on model)

This information is only relevant for recycling. There is no risk during normal operation.



▶ The oil in the compressor can be fatal if swallowed or if it penetrates the airways.

## Symbol on the rear of the appliance (depending on model)

This label or a similar one is only relevant for recycling. Do not remove the label.



▶ The note refers to foam panels in the appliance door and/or housing.

### Disposal of the packing material

The cardboard box and packing materials protect the appliance during shipping. They have been designed to be biodegradable and recyclable.

Ensure that any plastic wrappings, bags, etc. are disposed of safely and kept out of the reach of children. Danger of suffocation!

### Disposing of your old appliance

Electrical and electronic appliances contain many valuable materials. They also contain certain materials, compounds, and components which were essential for their correct functioning and safety. These could be hazardous to your health and to the environment if disposed of with household waste or if handled incorrectly. Please do not, therefore, dispose of your old appliance with household waste.



Take care not to damage your refrigerator before or during disposal in an authorized, environmentally-friendly manner.

This is to ensure that refrigerant in the cooling circuit and oil in the compressor is contained, and will not leak into the environment.

Instead, please make use of officially designated collection and disposal locations to dispose of and recycle electrical and electronic appliances in your local community, with your dealer, or with Miele, free of charge. By law, you are solely responsible for deleting any personal data from the appliance prior to disposal. You are legally obliged to remove any old batteries which are not

securely enclosed by the appliance and to remove any lamps without destroying them, where this is possible. These must be taken to a suitable collection point where they can be handed in free of charge. Please ensure that your old appliance poses no risk to children while being stored for disposal.

# Sustainability and environmental protection

---

## How to save energy ...

---

- Installation site** The refrigeration appliance has to cool more often at higher ambient temperatures and consumes more energy in the process. Therefore, you should:
- Install the refrigeration appliance in a well-ventilated room.
  - Do not install the refrigeration appliance near to a heat source (heater element, range).
  - Protect the refrigeration appliance from direct sunlight.
  - Ensure an ideal ambient temperature of 68°F (20°C).
  - Clean the ventilation gaps on a regular basis to remove any dust.
- Temperature setting** The colder the temperature, the higher the energy consumption. The following settings are recommended:
- 39 to 41°F (4 to 5°C) in the refrigerator section.
  - 0°F (-18°C) in the freezer zone
- Use** Energy consumption is increased by heat input and impeded air circulation. Therefore:
- Only open the appliance door/appliance doors when necessary and for as short a time as possible. Arrange the food in such a way that makes it easy to find in the appliance.
  - Always close the appliance door/appliance doors properly after opening it.
  - Allow hot food and drinks to cool down before placing them in the refrigeration appliance.
  - Store food well packaged or covered.
  - Do not overfill the compartments to allow air to circulate.
  - Keep drawers and shelves arranged as they were when the appliance was delivered.
  - Place frozen food in the refrigerator section to defrost.
  - Maintain a distance of 1" (25 mm) between the back of the appliance and the wall.

## Installation site

 Risk of fire and damage from appliances that give off heat.

Appliances that give off heat can catch fire and set fire to the refrigeration appliance.

The power cord must not come into contact with heat sources.

Do not place appliances which give off heat, such as mini-ovens, double burners, or toasters on the refrigeration appliance.

 Fire hazard and risk of damage from open flames.

Open flames can set fire to the refrigeration appliance.

Keep open flames (such as a candle) away from the refrigeration appliance.

 Risk of fire and damage due to improper installation.

If the electrical plug and power cords touch the back of the refrigeration appliance, they may be damaged by vibrations and cause a short circuit.

Electrical plugs or power cords must not touch the refrigeration appliance.

Power cords must not be trapped or damaged.

Do not connect any other appliances to sockets located directly behind this refrigeration appliance.

Do not place or operate power bars, distributor strips, or other electronic devices (such as halogen transformers) behind the appliance.

This appliance should be installed in a dry, well-ventilated room.

The floor at the installation site must be horizontal and level and must be as high as the surrounding floor.

 Risk of damage due to high humidity.

In environments with high humidity, condensation can build up on external refrigeration appliance panels.

This condensation can cause corrosion on external appliance panels.

Install the refrigeration appliance in a dry and/or air-conditioned room with sufficient ventilation.

After installation, please make sure that the appliance door/appliance doors closes/close properly and the refrigeration appliance is installed in accordance with these installation instructions. The ventilation opening specifications must be observed.

When deciding on the installation site, please bear in mind that your refrigeration appliance will use more energy if installed near to a heater, a range, or another appliance that gives off heat. Avoid direct sunlight. Higher ambient temperatures increase energy consumption as the compressor runs for longer.

# Installation

## Climate range

This refrigeration appliance is designed for use within specific ambient temperatures (climate range). Do not use in ambient temperatures for which it is not designed. The climate range is stated on the data plate in the interior cabinet of the refrigeration appliance.

Climate range	Ambient temperature
SN	50 to 90°F (10 to 32°C)
N	61 to 90°F (16 to 32°C)
ST	61 to 100°F (16 to 38°C)
T	61 to 109°F (16 to 43°C)
SN-ST	50 to 100°F (10 to 38°C)
SN-T	50 to 109°F (10 to 43°C)

A lower ambient temperature leads to the compressor switching off for longer periods. This can cause the internal temperature in the refrigeration appliance to rise with the risk of food deteriorating and going off.

## Ventilation requirements



Fire hazard and risk of damage due to inadequate ventilation. If the refrigeration appliance is not ventilated sufficiently, the compressor will run more frequently and for longer periods. This causes increased energy consumption and an increased compressor operating temperature, which can result in damage to the refrigeration appliance. Please ensure that there is adequate ventilation around the refrigeration appliance. It is essential to observe the required ventilation openings. The ventilation openings must never be obstructed. Clean the ventilation areas regularly to remove dust and dirt.

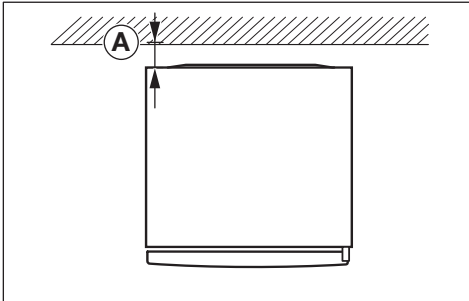

The energy consumption was calculated with a distance **A** = 1" (25 mm) between the back of the appliance and the wall. If the distance to the wall is less than 1" (25 mm), the functionality of the refrigeration appliance is maintained, but energy consumption increases slightly. Condensation can also form at high ambient temperatures.

Air at the back of the refrigeration appliance gets warm. Sufficient space for proper ventilation must therefore be ensured (see "Appliance dimensions").

## Installing several refrigeration appliances next to one another

**!** Risk of damage due to condensation on external appliance panels. In environments with high humidity, condensation can build up between the external refrigeration appliance panels, which can cause corrosion. Do **not** place different refrigeration appliances **directly** next to one another. A distance of at least 2 3/4" (70 mm) must be maintained between the refrigeration appliances.

## Door hinge change

**!** Risk of injury and damage to the appliance due to heavy door. There is an increased risk of injury and damage if the door hinging is installed by a single person. Always change the door hinging with the help of a second person.

**!** Risk of damaging the electrical components. There are live components on the door hinge (depending on the model). Switch off the appliance at the wall socket and withdraw the electrical plug before changing the hinging.

**i** Carry out the door hinge reversal according to the installation instructions (see QR-Code).



M.-Nr. 12083820

## Ordering printed installation instructions

You can order printed installation instructions free of charge from Miele. All the contact information you need for Miele can be found at the end of this document. Quote the model number and the serial number from the data plate when placing your order.

# Installation

## Installing the refrigeration appliance

**⚠** Risk of injury and damage due to the refrigeration appliance tipping over.

There is an increased risk of injury and damage if the refrigeration appliance is installed by a single person.

Two people are required for installing the refrigeration appliance.

**⚠** Risk of damage to the appliance door caused by impact.

The appliance door could hit the wall of the room resulting in damage to the door.

Install the door opening angle limiter supplied before the refrigeration appliance is installed.

Protect the appliance door by installing a felt stopper, for example, to the wall of the room.

**⚠** Risk of damaging the floor.

Moving the refrigeration appliance can cause damage to the floor.

Move the refrigeration appliance carefully on floors that are sensitive to scratching.

For easier installation, there are transport handles on the back at the top and transport wheels underneath the refrigeration appliance (depending on the model).

The refrigeration appliance must be empty when it is installed.

- Connect the refrigeration appliance to the power supply as described in “Electrical connection”.
- Move the refrigeration appliance carefully to its intended installation site.
- Position the refrigeration appliance with its back facing the wall, taking the necessary distance into account.

## Aligning the refrigeration appliance

**⚠** Risk of damage and injury caused by the appliance door falling out or the refrigeration appliance tipping over.

If the additional adjustable foot on the hinge plate at the bottom is not resting firmly on the floor, the appliance door can fall out or the refrigeration appliance can tip over.

Use the wrench supplied with the appliance to unscrew the adjustable foot until it is resting on the floor.

Then unscrew the adjustable foot by an additional quarter turn.

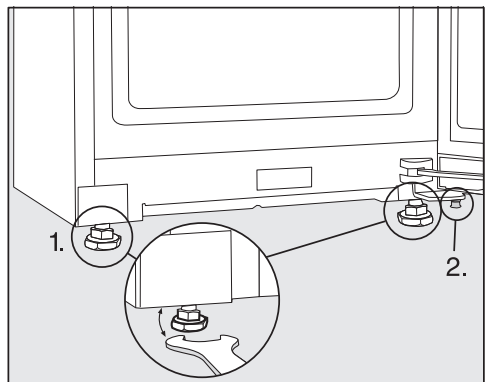

- Use a level and the supplied wrench to align the appliance and support the appliance door.

1. Adjust the front feet using the level as a guide.
2. Unscrew the additional adjustable foot until it is touching the floor. Then unscrew the adjustable foot by an additional quarter turn.

## Integrating the refrigeration appliance in a run of kitchen cabinets

The refrigeration appliance can be surrounded by kitchen cabinets.

The energy consumption was calculated with a distance of 1" (25 mm) between the back of the appliance and the wall. If the distance to the wall is less than 1" (25 mm), the functionality of the refrigeration appliance is maintained, but energy consumption increases slightly. Condensation can also form at high ambient temperatures.

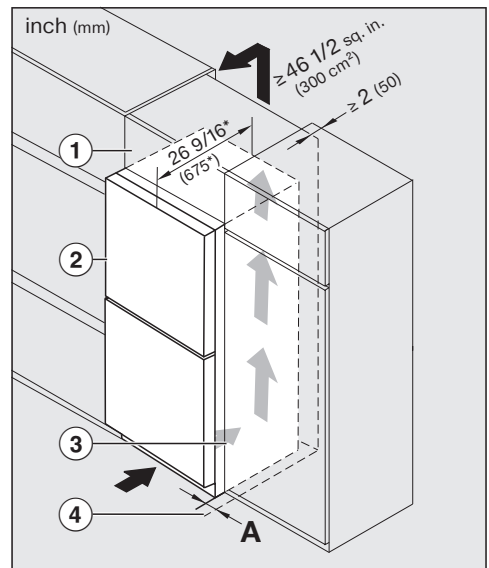

KFN 4xxx X **edt/cs**

- ① Top cabinet
- ② Refrigeration appliance, door depth = 3" (75 mm)
- ③ Kitchen cabinet
- ④ Wall

**A** = 1" (25 mm) (with recessed grip)/2 3/8" (60 mm) (with handle)

# Installation



Fire hazard and risk of damage due to inadequate ventilation.

If the refrigeration appliance is not ventilated sufficiently, the compressor will run more frequently and for longer periods. This causes increased energy consumption and an increased compressor operating temperature, which can result in damage to the refrigeration appliance.

Please ensure that there is adequate ventilation around the refrigeration appliance.

It is essential to observe the required ventilation openings.

The ventilation openings must never be obstructed.

Clean the ventilation areas regularly to remove dust and dirt.

The larger the ventilation openings, the less energy the compressor will use.

■ Install the refrigeration appliance next to the kitchen cabinet.

- The appliance front must protrude in front of door fronts by at least the door depth. This enables the appliance door to be opened and shut without being obstructed.
- When installed next to a wall ④, a distance (A) must be maintained on the hinge side between the wall ④ and the refrigeration appliance ②.
- To match the height of the rest of the kitchen cabinetry, the refrigeration appliance can be equipped with a suitable top cabinet ①.

An air outlet of at least 2" (50 mm) depth must be provided across the whole width of the top cabinet.

The ventilation cross-section under the ceiling must be at least 46 sq inch (300 cm<sup>2</sup>) to ensure that warm air can escape without obstruction.

## Appliance dimensions

### Installation dimensions/View from above

KFN 4776 ED edt/cs

All dimensions are given in inches (mm).

The refrigeration appliance will function correctly if the specified ventilation gaps are kept clear.

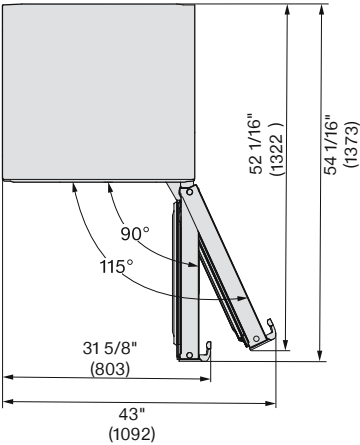
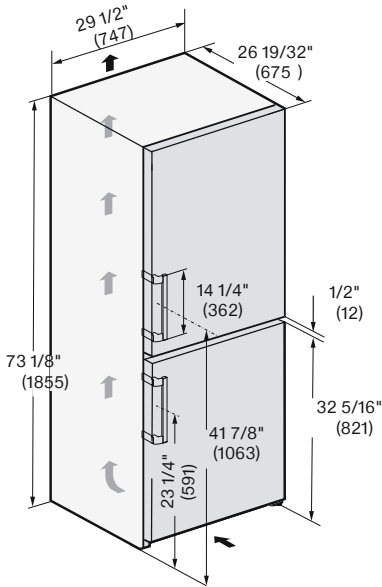

# Installation

---

## Connections

KFN 4776 ED edt/cs

All dimensions are given in inches (mm).

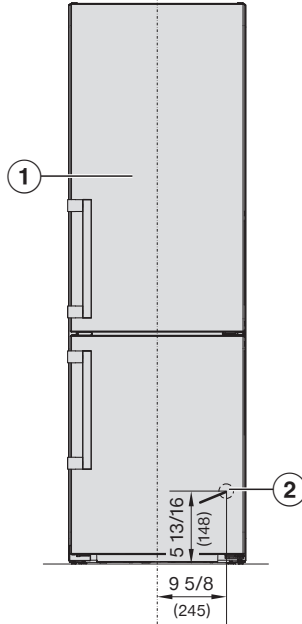

① Front view

② Power cord, length = 78" (2,000 mm)

## Electrical connection

### Risk of electric shock!

The refrigeration appliance must only be switched on when it has been installed in accordance with the installation instructions.

Ground the refrigeration appliance.

The refrigeration appliance must not be grounded via a gas pipe.

If in doubt, have a suitably qualified and experienced electrician check that the installation complies with relevant regulations.

Do not install a fuse into neutral current or grounding electrical circuit.

Do not use an extension cord or power bar.

Do not use a frayed or damaged power cord.

### Risk of electric shock!

For protection against electric shock, this refrigeration appliance is equipped with a pole-free electrical plug which is protected against reverse polarity. The electrical socket must be properly grounded.

Do not remove the round grounding connector pin from the electrical plug.

Use only a grounded plug adapter.

Wait for 1 hour after installation before plugging the refrigeration appliance into the electricity supply. This allows coolant and refrigeration oil to settle in accordance with regulations.

Ensure that the voltage of the power supply corresponds with the connection voltage of the appliance. A power supply of 110–120 V, 60 Hz and 10–16 Amp, which is protected by a power switch or a fuse, is required to operate the appliance.

The manufacturer recommends operating the refrigeration appliance on a separate circuit to avoid overloading the electrical circuit.

All relevant legal electrical, fire, and building regulations must be observed when installing the socket and/or the refrigeration appliance.

In certain countries, refrigeration appliances are required to be connected to the electrical supply via a wall-mounted ON/OFF switch.

To avoid the risk of fire, electric shock, or other injuries, the refrigeration appliance must be installed and connected by a suitably qualified electrician in accordance with all relevant local and national regulations and standards, including fire prevention.

The outlet must not be concealed behind the refrigeration appliance and must be easily accessible so that the appliance can be quickly disconnected from the electrical supply in case of an emergency.

If the outlet is no longer accessible after installation, an additional means of disconnection must be provided for all poles. Suitable means of disconnection include switches with an all-pole con-

# Installation

tact gap of at least 1/8" (3 mm). These can be circuit breakers, fuses, and relay switches.

The electrical plug and power cord must not come into contact with the back of the refrigeration appliance as vibrations can cause damage to these components. This could result in a short circuit.

Do not plug in other appliances behind the refrigeration appliance.

Temporary or permanent operation on an autonomous power supply system or a power supply system that is not synchronized with the grid power supply (e.g., island networks, back-up systems) is possible. A prerequisite for operation is that the power supply system complies with national and local codes. The function and operation of the protective measures provided in the domestic electrical installation and in this Miele product must also be maintained in isolated operation or in operation that is not synchronized with the grid power supply, or these measures must be replaced by equivalent measures in the installation.

The refrigeration appliance must not be used with so-called **energy saving devices** either. These reduce the amount of energy supplied to the appliance, causing it to overheat.

If the power cord needs to be replaced, this must be performed by a qualified electrician.

## Connecting the refrigeration appliance

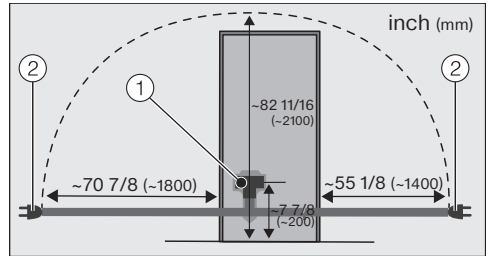

Back of the refrigeration appliance

- ① Appliance plug connector
- ② Electrical plug

■ Plug the appliance plug connector into the socket.

Make sure that the electrical plug has clicked into position correctly.

■ Insert the electrical plug of the refrigeration appliance into the socket.

The refrigeration appliance is now connected to the electricity supply.

## Appliance overview

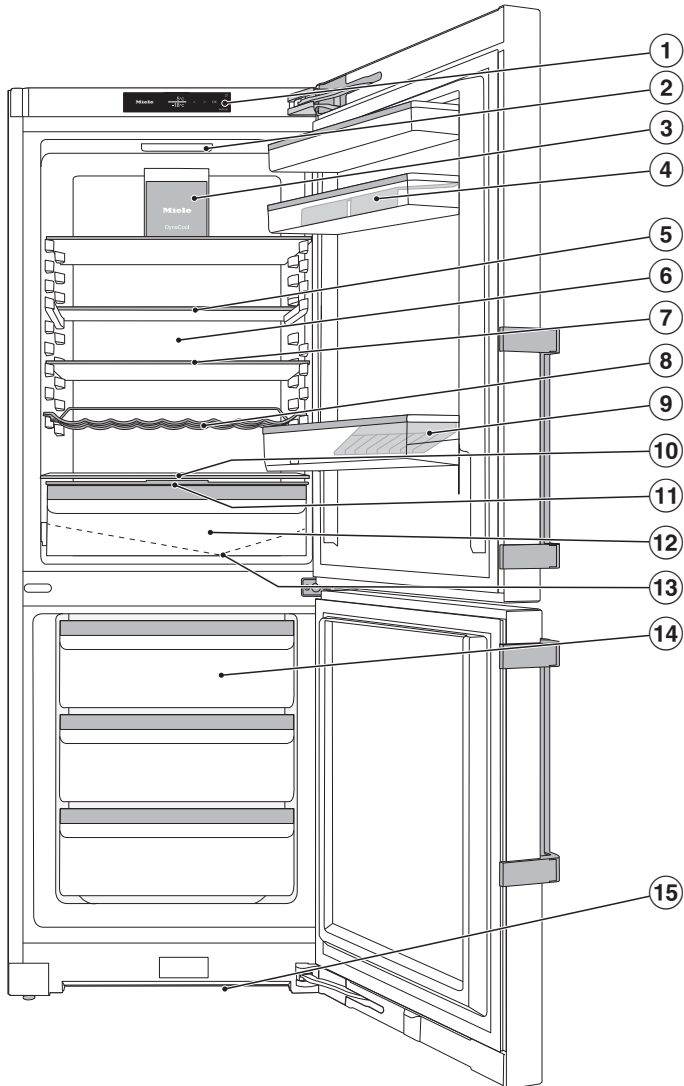

# Guide to the appliance

---

- ① Display
- ② Interior lighting (SmartLight):  
The interior lighting adapts to the lighting conditions in the room.
- ③ Fan
- ④ Shelf with egg tray in the appliance door
- ⑤ Split shelf (FlexiBoard):  
Slide the front section of the glass plate backward to create space for tall containers in the front area.
- ⑥ Dry back wall to prevent condensate
- ⑦ Adjustable shelf
- ⑧ Flexible bottle rack
- ⑨ Door rack for bottles with bottle holder:  
You can move the bottle holder to the right or left to create space for drinks cartons.
- ⑩ Space for a baking tray (XL interior)
- ⑪ Compartment lid for setting the humidity level in the DailyFresh drawer
- ⑫ DailyFresh drawer for fruit and vegetables (humidity-controlled)
- ⑬ Condensate channel and condensate drain hole:  
Precipitated condensate runs off and evaporates automatically.
- ⑭ Freezer drawers
- ⑮ Ventilation gap

## Control panel with status display

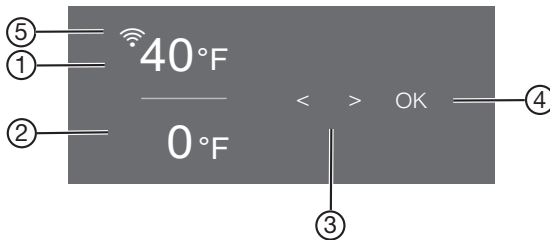

- ① Temperature display for the refrigerator section
- ② Temperature display for freezer section
- ③ Sensor controls for selecting a setting
- ④ OK sensor control for confirming a selection and accessing Settings mode ⚙️
- ⑤ Display for connection status (only visible if networking has been set up)













### Settings mode ⚙️

In Settings mode, you can select the following appliance functions and alter their settings to some extent:



Symbol	Function	Factory default
🔒	Switching the Party-mode function on or off (see “Selecting additional settings”)	Off
🌞	Switching the Vacation-mode function on or off (see “Selecting additional settings”)	Off
🔒/🔓	Switching the lock function on or off (see “Selecting additional settings”)	🔒 (Off)
🔌	Switching the refrigeration appliance off (see “Switching on and off”)	
🕯️	Switching the Sabbath-mode function on or off (see “Selecting additional settings”)	Off

## Guide to the appliance

---

	Calling up the Sabbath mode version	—
	Changing the time before the door alarm is triggered (see “Selecting additional settings”)	1:00
	Changing over the cooling circuit (metrological function, not relevant for the customer)	Off
	Setting up the Miele@home function for the first time, activating and deactivating WiFi, or resetting the network configuration (see “Selecting additional settings”)	APP
	Switching the keypad tone on or off	On
	Changing the volume of the alarms and audible signals or switch them off entirely (see “Selecting additional settings”)	On /level 5
	Changing the display brightness (see “Selecting additional settings”)	Level 4
	Changing the temperature unit (°Celsius or °Fahrenheit)	°F
	Switching the Demo-mode function off (only visible when switched on) (see “Selecting additional settings”)	Off
	Resetting to default settings (see “Selecting additional settings”)	—
	Calling up information (model number and serial number) about your refrigeration appliance (see “Selecting additional settings”)	—
	Switching on the reminder to change the carbon filter (see “Optional accessories”) (see “Selecting additional settings”)	Off
	Switching Cleaning mode on or off (see “Cleaning and care”)	Off

## Selecting the desired function in Settings mode



- Touch the *OK* sensor control on the control panel.
-  will appear in the display (refrigerator section is selected).
- Use the < or > sensor control to scroll to the  symbol.
- Touch *OK*.
- Select the function you want using the < or > sensor control.
- Touch *OK* to select the function you want.

When the function is **switched on**, a dot appears in the upper corner of the display .

- Touch *OK* to deselect a selected function.

When the function is **switched off**, the dot in the upper corner of the display goes out.

## Exiting Settings mode

- Use the < or > sensor control to scroll to the  symbol.
- Touch *OK*.
- Use the < or > sensor control to scroll to the  symbol and touch *OK*.
- **Alternatively:**  
Wait approx. 15 seconds after the last press of a button.  
Settings mode is then exited automatically.

# Guide to the appliance

## Adjusting the interior fittings

### Moving the door shelf/bottle shelf

Only move the door/bottle shelves in the appliance door when they are empty.

- Push the door/bottle shelves upward, then remove them by pulling them forward.
- Replace the door/bottle shelves at the required height.

### Moving the adjustable shelves

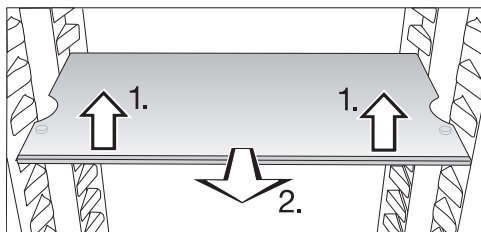

- Raise the shelf slightly at the front and pull it forward a little.
- Lift it until the notches at the side are in line with the shelf supports. The shelf can then be raised or lowered to the required level.
- Push the shelf in.

Stoppers prevent the shelves from being dislodged by mistake.

### Sliding back the split shelf

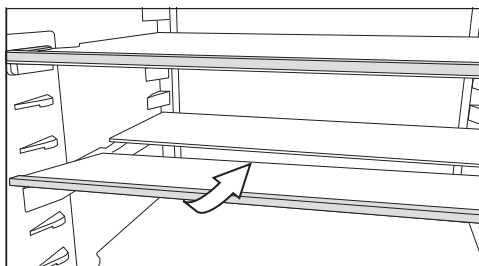

- Lift up the front section of the glass plate slightly at the front and slide it carefully underneath the rear section.

### Moving the split shelf

- Take both sections of the glass plate out of the appliance.

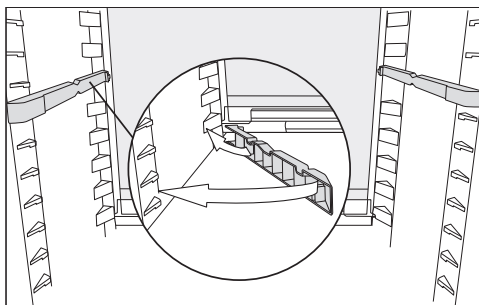

- Attach the two adapters to the support ribs on the left and right at the desired height.

The section of the glass plate with the raised edge must be installed at the back.

### Space for a baking tray

A baking tray can be placed above the drawers.

- Open the appliance door as far as it will go.

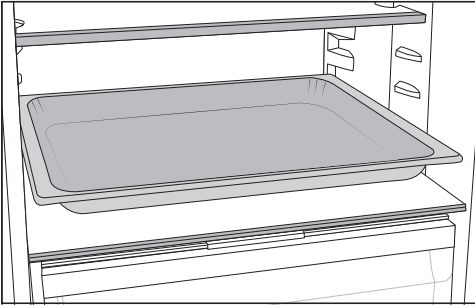

## Flexible configuration of the freezer zone (VarioRoom)

If you wish to freeze large items such as turkey or game, you can remove the upper freezer drawers and the glass plates between the drawers. This creates more volume and space for storing bulky and tall items of frozen food.

- Place the baking tray on the dividing plate.

**Tip:** Let the baking tray cool down to room temperature before putting it in the refrigerator section.

## Moving the Active AirClean filter

The holder for the Active AirClean filters sits on a protective strip at the back of the shelf.

- To move the Active AirClean filter, pull it upward to remove it from the protective strip.
- Then pull the protective strip off the shelf.
- Reinstall it on the shelf you wish to use it on.

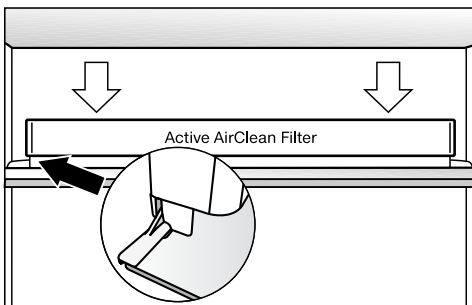

- Reinstall the Active AirClean filter on the protective strip.

# Guide to the appliance

---

## Accessories supplied

### Egg tray

### Ice cube tray

### Door opening angle limiter

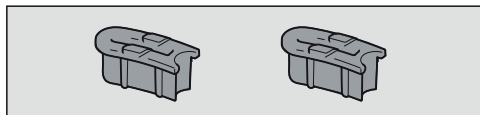

The door hinges are set at the factory to enable the appliance door to be opened up to 115°. If the appliance door hits an adjacent wall when opened, for example, the opening angle can be limited to approx. 90°.

Carry out installation as described in the installation instructions supplied with the appliance.

## Optional accessories

A range of useful Miele accessories and care products are available for your appliance.

Products specially tailored to your refrigeration appliance – such as appliance care products and accessories – are available from the Miele online store, Miele Service, or your Miele dealer.

You can access the Miele online store via the following QR code:



## Before using for the first time

- Remove all packaging material and protective film.
- Clean the inside of the appliance and the accessories.

## Connecting the appliance

- Connect the refrigeration appliance to the electricity supply as described in “Electrical connection”.

Miele will then appear on the appliance display, followed by .

## Switching on the appliance

- Open the appliance door.
- Touch the *OK* sensor control on the control panel.

The refrigeration appliance will start to cool and the interior lighting will come on when the appliance door is opened.

When the set freezer temperature is reached, the  symbol disappears, the temperature display of the freezer section lights up constantly and the alarm stops.

- To turn the alarm off, tap *OK*.

The alarm will stop.







The refrigeration appliance will gradually reach the preset temperatures.

To enable the temperature to get sufficiently cold inside the refrigeration appliance, allow the appliance to run for a few hours. Do not place food in the refrigeration appliance until it has reached the preset temperature.

Do not place food in the freezer section until it has reached the preset temperature (min. 0°F/-18°C).

## Switching off the appliance

You can only switch the entire refrigeration appliance off in Settings mode .

- Touch the *OK* sensor control on the control panel.
-  will appear in the display (refrigerator section is selected).
- Use the  or  sensor control to scroll to the  symbol.
- Touch *OK*.
- Use the  or  sensor control to scroll to the  symbol.
- Touch *OK*.



The cooling and interior lighting are switched off.

 will appear on the display.

Please note: The refrigeration appliance is not disconnected from the power supply when it is switched off.

## Turning off the refrigerator section separately

The refrigerator section can be switched off without having to switch off the freezer section. This is useful, e.g., while on vacation.

- Touch the *OK* sensor control on the control panel.
-  will appear in the display (refrigerator section is selected).
- Touch *OK*.
- Use the  sensor control to scroll to the  symbol.
- Touch *OK*.

The temperature display for the refrigerator section will go out.  will appear in the display.

The refrigerator section will be turned off.

## Switching on and off

The temperature display for the freezer section remains lit up.

### Switching the refrigerator section back on again separately

- Touch *OK*.
- 🔊 will appear in the display (refrigerator section is selected).
- Touch *OK*.
- Use the > sensor control to scroll to the temperature you want and touch *OK*.

The refrigerator section switches back on.

### Switching off for longer periods of time

If, during a long absence, the refrigeration appliance is switched off but not cleaned and the door is left shut, there is a danger of bacteria building up inside the appliance. It is essential to clean the refrigeration appliance before a long period of absence.

If the refrigeration appliance is not going to be used for a longer period of time, observe the following:

- Turn the appliance off.
- Unplug the appliance's electrical plug or switch off the breaker.
- Clean the refrigeration appliance and leave the door open to air the appliance and avoid odors building up inside.

It is also advisable to carry out the last two instructions if you are switching the refrigerator section off for a longer period of time.

## Requirements for networking

Note the following requirements for networking:

1. A home network is available at the installation site.  
Have the Wi-Fi password ready.
2. The Miele app is available on a mobile device.
3. You have a user account in the Miele app.

### Miele App

The Miele App is available to download free of charge from the Apple App Store® or from the Google Play Store™.



### Setting up networking for the first time

- Touch *OK*.
- 🔊 appears on the display.
- Use the < or > sensor control to scroll to the ⚙️ symbol.
- Touch *OK*.
- Use the < or > sensor control to scroll to the @ symbol.
- Touch *OK*.
- Use the < and > sensor controls to select the connection method you wish to use (app or WPS).
- Touch *OK*.
- **To leave Settings mode** ⚙️, use the < or > sensor control to scroll to the ↩️ symbol.

- Touch *OK*.
- Use the < or > sensor control to scroll to the ↶ symbol and touch *OK*.

After you have successfully logged in,  will appear on the display.

If a connection could not be created,  will appear.

Start the process again.

### Performing Scan & Connect

- Scan the QR code.

If you have installed the Miele app and have a user account, you will be taken directly to the networking steps.

If you have not yet installed the Miele app, you will be taken to the Apple App Store® or the Google Play Store™.

- Install the Miele app and set up a user account.
- Scan the QR code again.

The Miele app will guide you through the setup process.

(depending on the model)



# Operation

## The correct temperature

It is very important to set the correct temperature to ensure the shelf life of food. Reducing the temperature reduces the growth rate of microorganisms.

Food does not spoil as quickly.

The temperature in the appliance will rise:

- the more often the appliance door is opened and the longer it is kept open
- the more food that is stored in it
- the warmer the food is that is being put into it
- the higher the ambient temperature surrounding the refrigeration appliance is. This refrigeration appliance is designed for use within specific ambient temperatures (climate range). Do not use in ambient temperatures for which it is not designed.

### ... in the refrigerator section

A temperature of **39°F (4°C)** is recommended in the refrigerator section.

### ... in the freezer zone

To freeze fresh food, a temperature of **0°F (-18°C)** is required. This will prolong the storage life of your food and retain its quality.

As soon as the temperature rises above 14°F (-10°C), the bacteria become active in the food again so it cannot be kept as long. For this reason, partially defrosted or defrosted food must not be re-frozen. Food may be re-frozen once it has been cooked (boiled or roasted), as the high temperatures achieved when cooking destroy most bacteria.

By keeping the freezer section at a constant temperature of 0°F (-18°C) and taking appropriate hygiene measures you can maximize the storage life of your food and avoid food waste.

## Temperature display

In normal operation, the refrigeration appliance temperature display shows the **current average fridge zone temperature** and the **maximum freezer zone temperature**.

Depending on the ambient temperature and the temperature setting, it can take the appliance a few hours to reach the temperature required and for this temperature to then be shown as a constant temperature on the display.

## Setting the temperature in the refrigerator/freezer sections

- Touch the *OK* sensor control on the control panel.
-  will appear in the display (refrigerator section is selected).
- Use the < and > sensor controls to change the selected temperature zone if required.
- Touch *OK*.
- Use the < and > sensor controls to change the temperature.
- Touch *OK*.

The temperature display will then change back to the current temperature in the relevant temperature zone.

## Possible temperature settings

- Refrigerator section: 36 to 48°F (2 to 9°C)
- Freezer section: 5 to 15°F (-15 to -26°C)

## Temperature and door alarm

 Health risk caused by contaminated food.

If the temperature in the freezer remains above 0°F (-18°C) for a long time, the frozen food may start to defrost. This will reduce the storage life of the food.

Check whether the frozen food has started to defrost. If it has, use the food as soon as possible or cook it before freezing it again.

## Temperature alarm

The refrigeration appliance has been equipped with a temperature alarm so that the temperature in the freezer zone cannot rise unnoticed.

If the temperature in the freezer zone becomes too warm,  will be shown on the temperature display for the freezer zone.

An alarm will also sound until the cause of the alarm is rectified or the alarm is switched off.

The temperature the appliance is set at determines the temperature the appliance recognizes as being too warm.

A temperature alarm has priority over a door alarm and is displayed first.

The audible and visual signals may be activated in the following situations:

- You switch on the refrigeration appliance and the temperature in a temperature zone differs greatly from the set temperature.
- A lot of warm room air enters the freezer zone when you are rearranging or taking out frozen food.
- You are freezing large amounts of food at once.
- You are freezing warm food.
- A power outage has occurred.
- The refrigeration appliance has a fault.

Before you switch the temperature alarm off, you must determine the cause and rectify it.

If the alarm disturbs you, it can be turned off early.

■ Touch *OK*.

The alarm message is confirmed:  goes out and the alarm stops.

The start screen appears in the display: the warmest temperature recorded in the freezer section will flash for about 1 minute in the display. Then the temperature display will change to the current temperature in the freezer section.

The alarm will stop. The  symbol will go out when the temperature reaches the correct level again.

# Operation

## Door alarm

If an appliance door is left open for a longer period of time, the  symbol will appear on the relevant temperature display. An alarm will also sound and the interior lighting will flash.

The amount of time before the door alarm is triggered can be changed (see “Selecting additional settings – Changing the time before the door alarm is triggered”).

The door alarm’s audible signal can be switched off (see “Selecting additional settings – Changing the volume of the alarms and audible signals”).

As soon as the door is closed, the alarm stops sounding and the  symbol disappears from the display.

## Turning the door alarm off early

- Touch *OK*.

 will go out and the alarm will stop. The interior lighting will light up constantly.

If the appliance door is not closed, the door alarm will sound again after around 1 minute.

## Using Automatic SuperCool, SuperFrost, and DynaCool

### SuperCool

When switched on, the SuperCool function  can be used to rapidly reduce the temperature in the **fridge zone** to its lowest setting (depending on the ambient temperature). The refrigeration appliance will work at full power and lower the temperature. Select this function for the rapid chilling of large amounts of fresh food or drink.



When the SuperCool function  is switched on, the appliance may make more noise than usual.

The SuperCool function  should be switched on immediately before placing food or drinks in the fridge zone.

The SuperCool function  will switch itself off automatically after approx. 12 hours. The refrigeration appliance will then run at normal power again.

**Tip:** To save energy, you can switch off the SuperCool function  yourself once food and drinks are sufficiently chilled.

### Switching Automatic SuperCool on and off

- Touch the *OK* sensor control on the control panel.
-  will appear in the display (refrigerator section is selected).
- Touch *OK*.
- Use the < sensor control to scroll to the  symbol.

## ■ Touch *OK*.

When the Automatic SuperCool function ❄️ is **switched on**, a dot appears in the upper corner of the display •.

- Use the > sensor control to scroll to the temperature you want and touch *OK*.

## SuperFreeze ❄️

When switched on, the SuperFreeze function ❄️ can be used to rapidly reduce the temperature in the **freezer section** to its lowest setting (depending on the ambient temperature). The refrigeration appliance will work at full power and lower the temperature. Select this function before freezing fresh food. Fresh food will be frozen quickly, so that the nutritional value, vitamin content, appearance, and taste are maintained.

When the SuperFreeze function ❄️ is switched on, the appliance may make more noise than usual.

SuperFreeze should be switched on approx. **6 hours before** placing food in the freezer section.

When freezing the **maximum amount of food**, the SuperFreeze function ❄️ should be switched on **24 hours beforehand**.

The SuperFreeze function ❄️ will switch itself off automatically after a maximum of 72 hours. The appliance will then run at normal power again. The exact amount of time will vary according to how much fresh food is placed in the freezer.

**Tip:** To save energy, you can switch the SuperFreeze function off yourself once food and drinks are sufficiently chilled.

You do not need to switch on the SuperFreeze function:

- When you place food that is already frozen in the freezer.
- If you are only freezing up to 4.4 lb (2 kg) of fresh food daily.

## Switching SuperFrost ❄️ on and off

- Touch the *OK* sensor control on the control panel.
- ❏ will appear in the display (refrigerator section is selected).
- Use the > sensor control to scroll to the ❏ symbol.
- Touch *OK*.
- Use the < sensor control to scroll to the ❄️ symbol.
- Touch *OK*.

When the SuperFrost function ❄️ is **switched on**, a dot appears in the upper right-hand corner of the display •.

- Use the < and > sensor controls to scroll to the temperature you want and touch *OK*.

# Operation

## DynaCool



When the DynaCool function  is not switched on, the natural circulation of air in the appliance will cause different temperature zones in the refrigerator section, as the cold, heavy air will sink to the lowest section of the appliance. You should keep this in mind when placing food in the appliance (see “Storing food in the refrigerator section”).

However, if you are storing a large amount of similar food in the refrigerator at any one time, e.g., after your weekly shop, it is a good idea to turn on DynaCool. This way you can distribute the temperature more evenly across all the shelves so that all the food in the refrigerator section will be chilled to about the same degree. The temperature can still be set.

Also switch on the DynaCool function  when:



- The ambient temperature is high (above approx. 85°F/30°C)
- The humidity levels are high (e.g., in the summer)



The fan will always switch on automatically when the compressor switches on.

**Tip:** As the energy consumption increases when DynaCool  is switched on, you should turn the DynaCool function  off again under normal conditions.

To save energy, the fan turns off automatically while the door is open.

## Switching DynaCool on and off

- Touch the *OK* sensor control on the control panel.
-  will appear in the display (refrigerator section is selected).
- Touch *OK*.
- Use the < sensor control to scroll to the  symbol.
- Touch *OK*.

When the DynaCool function  is **switched on**, a dot appears in the upper corner of the display .

- Use the > sensor control to scroll to the temperature you want and touch *OK*.

## Storing food in the fridge zone

Do not load more than a maximum of 35 lb (16 kg) of food in the appliance door.

 Risk of fire from electrical appliances.

Operating electrical devices in the appliance can cause sparks to form. Do not operate any electrical devices inside the appliance.

## Different storage zones

Due to natural air circulation, there are different temperature zones in the refrigerator section.

Cold, heavy air sinks to the lowest section of the refrigeration section. Make use of the different zones when placing food in the appliance.

This is a refrigeration appliance with dynamic cooling. When the fan is running, the cold is evenly distributed in the fridge zone. The difference between the various temperature zones is less pronounced.

## Warmest area

The warmest area in the refrigerator section is in the top section of the door. Use this for storing butter so that it remains spreadable and cheese so that it retains its flavor.

## Coldest area

The coldest area in the fridge zone is directly above the DailyFresh drawer and at the back of the appliance.

A temperature setting of 39°F (4°C) combined with appropriate hygiene measures delays the growth of bacteria, e.g., salmonella and listeria, which can lead to serious food poisoning.

Therefore, you should use these areas to store all delicate and highly perishable food, including:

- fish, meat, poultry
- cold cuts, ready-made meals
- dishes or baked goods containing eggs or cream
- fresh dough, cake mixtures, pizza dough, or pie dough
- raw milk cheese and other raw milk products
- hummus, vegetable spreads, plant-based cream cheese substitutes
- pre-packed vegetables
- other fresh food (with a label stating it should be kept at a temperature of around 39°F (4°C))

## Should food be stored loose or in packaging?

Ensure that food stored in the fridge zone is in packaging or covered properly (some exceptions apply in the DailyFresh drawer).

This will prevent food odors from affecting other food, stop food from drying out, and also prevent any cross-contamination of bacteria. This is particularly important when storing meat products. Make sure that food such as raw meat and fish in particular does not come into contact with other food.

By ensuring that the temperature settings are correct and by taking appropriate hygiene measures, you can prolong the storage life of your food considerably. This prevents food waste.

## Protein-rich food

Please note that foods rich in protein deteriorate faster than others. Shellfish, for example, deteriorates faster than fish, and fish deteriorates faster than meat.

# Operation

## Storing food in the DailyFresh drawer

The DailyFresh drawer provides good storage conditions for fruit and vegetables.

The humidity level in the DailyFresh drawer can also be regulated to suit the food being stored. Food retains its own moisture if stored at a higher humidity and so does not dry out as quickly. The temperature is approximately equivalent to the temperature in the conventional refrigerator section.

Remember that the fresher the food when it is placed in the appliance, the longer it will stay fresh.

## Adjusting the humidity level in the DailyFresh drawer for fruit and vegetables

The moisture level greatly depends on the type and quantity of food being stored, if stored unwrapped. If the quantity of food being stored in this compartment is small, the humidity level may be too low.

**Tip:** If you are only storing a small amount of food, wrap it in airtight packaging.

### Selecting low humidity $\Delta$

By factory default, the humidity is increased and the compartment cover pushed backward  $\Delta\Delta\Delta$ .

Only change this factory default setting if the humidity level in the DailyFresh drawer is too high:

- Open the DailyFresh drawer.

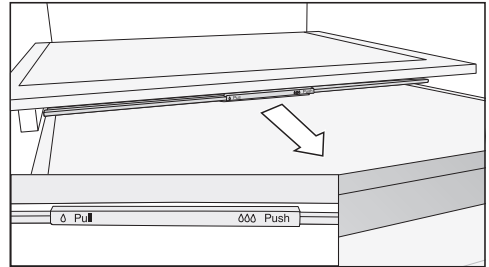

- Pull the compartment lid forward as far as it will go.

The compartment lid is open and the humidity drops  $\Delta$ .

### Selecting increased humidity $\Delta\Delta\Delta$

- Open the DailyFresh drawer.

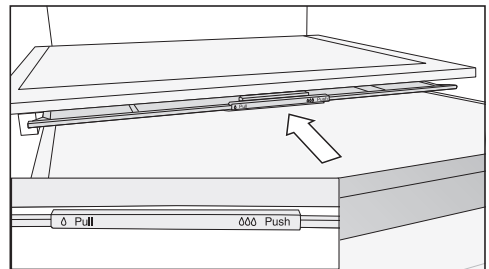

- Slide the compartment lid backward as far as it will go.

The compartment lid is closed and the humidity remains in the compartment  $\Delta\Delta\Delta$ .

## Freezing and storing fresh food

### Before placing food in the freezer

- When freezing more than 4.4 lb (2 kg) of fresh food, switch on the SuperFreeze function ❄️ for 6 hours before placing the food in the freezer.
- When freezing even larger amounts of food, switch on the SuperFreeze function ❄️ for 24 hours before placing the food in the freezer.

This helps frozen food which is already stored in the freezer to stay frozen.

- Only freeze food that is fresh and in good condition.

Please note that some food is not suitable for freezing. This includes, for example, vegetables that are usually eaten raw, such as lettuce or radishes.

### Placing food in the freezer

⚠️ Risk of damage due to heavy loads.

Loading food which is too heavy can cause damage to the freezer drawers/glass shelves.

Do not exceed the relevant maximum load:

Freezer drawer = 33 lb (15 kg)

Glass shelf = 77 lb (35 kg)

Unfrozen food should not touch frozen food as this will cause the frozen food to begin to thaw.

- To prevent food sticking together when frozen, make sure that the packaging and containers are dry.

To ensure that food freezes through to the core quickly, do not exceed the following packaging and container sizes:

- fruit and vegetables: max. 2.2 lb (1 kg)
- meat: max. 5.5 lb (2.5 kg)

### – Freezing small amounts of food

Freeze food in the top freezer drawer.

- Always place the food as far back as possible in the freezer drawer – close to the rear panel – so that it freezes through to the core as quickly as possible.

### – Freezing the maximum amount of food (see data plate)

Distribute the food in the upper freezer drawers. Only store food that has already been frozen in the bottom drawer.

- Always place the food as far back as possible in the freezer drawer – close to the rear panel – so that it freezes through to the core as quickly as possible.

### Cooling drinks quickly

To cool drinks quickly in the refrigerator section, switch on the Automatic SuperCool function ❄️.

If you want to cool a large amount of drinks, or if you want to cool drinks in the freezer section, select Party mode 🎉 in Settings mode ⚙️.

When cooling drinks quickly in the freezer, make sure bottles are not left in for **more than one hour**. Otherwise they could burst.

# Operation

---

## Making ice cubes

- Fill the ice cube tray  $\frac{3}{4}$  full with water and place it on the bottom of one of the freezer drawers.
- Once frozen, use a blunt instrument such as a spoon handle to remove the ice cube tray from the freezer if it is stuck.

**Tip:** Ice cubes can be removed easily from the tray by holding it under running water for a short time.

## Selecting additional settings

### Explanation of the different settings



Only the settings that require further explanation are described below.



The door alarm and other warnings are automatically suppressed when you are in Settings mode .



### Party mode

The Party-mode function  is recommended if you wish to chill or freeze large amounts of fresh food or drink quickly.

**Tip:** Switch on the Party-mode function  approx. 4 hours before placing food and drinks in the appliance.

When Party mode  is switched on, the DynaCool , Automatic SuperCool, and SuperFrost  functions are switched on automatically.

Party mode  cannot be switched on if the refrigerator section is switched off or if Vacation mode  is switched on.

The Party-mode function  will switch itself off automatically after approx. 24 hours. However, you can switch the Party-mode function  off early at any time.

### Vacation mode

The Vacation-mode function  is useful when you go on vacation, for example, if you do not wish to switch off the refrigerator section completely or do not need a high degree of cooling.

If Vacation mode  is switched on, this will be indicated on the status display.

The refrigerator section is regulated to a temperature of 60°F (15°C), thus remaining in operation while saving energy.

The freezer section remains switched on at the previously set temperature.

Food which does not spoil quickly can be stored in the refrigeration appliance for some time at this moderate refrigerator temperature. Energy consumption is lower than in normal operation. This also prevents the build-up of odors and bacteria which can occur if the refrigerator section is switched off and the appliance door is closed.

 Health risk caused by contaminated food.



The usability and quality of food in the refrigerator section may deteriorate if the temperature remains above 37°F (4°C) for an extended period.



Only ever switch on the Vacation-mode function  for a limited period.

Do not store any temperature-sensitive food which spoils easily, such as fruit, vegetables, fish, meat, and dairy products, during this time.

### Switching the safety-lock function on

When the safety-lock function  is switched on, it protects the refrigeration appliance from being switched off unintentionally and being adjusted unintentionally by unauthorized persons, e.g., children.

- In Settings mode , use the < or > sensor control to scroll to the  symbol.
- Touch OK.

When the safety-lock function  is switched on, a dot appears in the upper corner of the display .

- Close the appliance door. The safety-lock function  will now be activated.

## Selecting additional settings

### Deactivating the safety-lock function / temporarily

If you want to adjust the temperature, for example, you can deactivate the safety-lock function temporarily:

- Touch *OK*.

 will appear in the display.

- Touch the *OK* sensor control for approx. 6 seconds.

 will appear in the display (refrigerator section is selected).

- Use the < and > sensor controls to change the selected temperature zone if required.
- Touch *OK*.
- Now select the required settings.
- Touch *OK*.

Closing the appliance door will reactivate the safety-lock function .



### Switching the safety-lock function / off completely

- Touch *OK*.

 will appear in the display.

- Touch the *OK* sensor control for approx. 6 seconds.

 will appear in the display (refrigerator section is selected).

- Use the < or > sensor control to scroll to the  symbol.
- Touch *OK*.
- Use the < or > sensor control to scroll to the  symbol.
- Touch *OK*.

When the safety-lock function is switched off,  appears in the display.

### Sabbath mode

The refrigeration appliance features a Sabbath mode for the purposes of religious observance.

If Sabbath mode  is switched on, this will be indicated on the start display.

The display switches off after 3 seconds.

When Sabbath mode  is switched on, you cannot make any settings on your refrigeration appliance.

Ensure that the appliance doors are properly closed, as audible and visual alarms are turned off.

The Sabbath mode function  will switch off automatically after approx. 80 hours.

When Sabbath mode  is switched on, the following are deactivated:

- the interior lighting when the appliance door is opened
- all audible and visual signals
- the temperature display
- an active Wi-Fi connection

All other functions switched on previously remain activated.



 Health risk caused by contaminated food.



As power failures are not indicated while Sabbath mode  is active, food may be exposed to increased temperatures for a certain period of time. This will reduce the storage life of the food.

If there is a power failure during Sabbath mode , check the quality of the food.

# Selecting additional settings

## Switching Sabbath mode on

- In Settings mode , use the < or > sensor control to scroll to the  symbol.
- Touch *OK*.

When the Sabbath-mode function  is switched on, a dot appears in the upper corner of the display .



The display switches off after 3 seconds.

- Close the appliance door.

## Switching Sabbath mode off

- Touch the *OK* sensor control.
-  will appear in the display.

- Touch *OK*.



When the Sabbath-mode function  is switched on, a dot appears in the upper corner of the display .

- Touch *OK*.

When the Sabbath-mode function  is switched off, the dot in the upper corner of the display goes out.

## Changing the time before the door alarm is triggered

You can set how quickly the door alarm should sound after an appliance door has been opened.

- In Settings mode , use the < or > sensor control to scroll to the  symbol.
- Touch *OK*.
- Use the < and > sensor controls to set the time you want between 30 seconds and 3 minutes: 30 seconds.
- Touch *OK*.

## Networking

Your refrigeration appliance is equipped with an integrated Wi-Fi module. The Wi-Fi module makes it possible to connect to your home network and to use the Miele app on a mobile device.

Once your refrigeration appliance has been connected via Wi-Fi, the connection is automatically re-established every time it is switched on.

Make sure that your Wi-Fi network signal is strong enough in the place where you intend to install your refrigeration appliance.

Connecting your refrigeration appliance to your Wi-Fi network will increase energy consumption, even when the appliance is switched off.

## Smart Extras via the Miele app\*

Networking via the Miele app gives you access to numerous Smart Extras, including:

- Access status information.
- Use additional helpful functions.
- Keep your refrigeration appliance up to date with the latest Miele developments via software updates.

You can find more detailed information about Smart Extras on the Miele website, in the Apple App Store<sup>®</sup>, or in the Google Play Store<sup>™</sup>.





## Selecting additional settings

\*This is a separate digital offer from Miele & Cie. KG. The range of functions can vary depending on the model and the country. Acceptance of the General Terms and Conditions and Privacy Policy for Miele digital products and services in the Miele app required. Miele reserves the right to change or discontinue the digital offers at any time.

### Setting up networking for the first time

- Touch *OK*.

 appears on the display.

- Use the < or > sensor control to scroll to the  symbol.
- Touch *OK*.
- Use the < or > sensor control to scroll to the  symbol.
- Touch *OK*.
- Use the < and > sensor controls to select the connection method you wish to use (app or WPS).
- Touch *OK*.
- **To leave Settings mode** , use the < or > sensor control to scroll to the  symbol.
- Touch *OK*.
- Use the < or > sensor control to scroll to the  symbol and touch *OK*.

After you have successfully logged in,  will appear on the display.

If a connection could not be created,  will appear.

Start the process again.

### Deactivating the Wi-Fi connection

- Touch *OK*.

 appears on the display.



- Use the < or > sensor control to scroll to the  symbol.

- Touch *OK*.

- Use the < or > sensor control to scroll to the  symbol.

- Touch *OK*.

If the Wi-Fi is deactivated, the  symbol will appear on the display.

- **To leave Settings mode** , use the < or > sensor control to scroll to the  symbol.





- Touch *OK*.



- Use the < or > sensor control to scroll to the  symbol and touch *OK*.

### Activating the Wi-Fi connection

- Touch *OK*.

 appears on the display.

- Use the < or > sensor control to scroll to the  symbol.
  - Touch *OK*.
  - Use the < or > sensor control to scroll to the  symbol.
  - Touch *OK*.
  - Use the < or > sensor control to scroll to the  symbol and touch *OK*.
- If the Wi-Fi is activated, the  symbol and a dot appear in the upper corner of the display .

- **To leave Settings mode** , use the < or > sensor control to scroll to the  symbol.

- Touch *OK*.

- Use the < or > sensor control to scroll to the  symbol and touch *OK*.

When the Wi-Fi connection is active, the  symbol appears on the display.

## Selecting additional settings

### Resetting the network configuration

- Touch *OK*.
- 📶 appears on the display.
- Use the < or > sensor control to scroll to the ⚙️ symbol.
- Touch *OK*.
- Use the < or > sensor control to scroll to the @ symbol.
- Touch *OK*.
- Use the > sensor control to scroll to the ☑️ symbol.
- Touch *OK*.
- Use the > sensor control to scroll to the X symbol.
- Touch *OK*.
- **To leave Settings mode** ⚙️, use the < or > sensor control to scroll to the ↩️ symbol.
- Touch *OK*.
- Use the < or > sensor control to scroll to the ↩️ symbol and touch *OK*.

All entered settings and values are reset to the default settings.

The Wi-Fi connection has been deactivated. 📶 will go out on the display.

Reset the network configuration if you are disposing of or selling your refrigeration appliance, or if you are putting a used refrigeration appliance into operation. All personal data is removed from the refrigeration appliance. This will also ensure that a previous owner is no longer able to access the refrigeration appliance.

### Changing the volume of the alarms and audible signals 🔊/🔇

You can change the volume of the alarms and audible signals (e.g., in the event of a door alarm or a fault message). Alternatively, you can switch the alarms and audible signals off if you find them annoying.

- In Settings mode ⚙️, use the < or > sensor control to scroll to the 🔊 symbol.
- Touch *OK*.
- Use the < and > sensor controls to select the volume you want for alarms and audible signals.
- Touch *OK*.

When the alarms and audible signals are switched off, 🔇 will appear.

### Adjusting the display brightness 🌞

You can adjust the display brightness to the lighting conditions in the room.

- In Settings mode ⚙️, use the < or > sensor control to scroll to the 🌞 symbol.
- Touch *OK*.
- Use the < and > sensor controls to select the display brightness you want.
- Touch *OK*.

### Switching off Demo mode 📺



Demo mode 📺 allows the refrigeration appliance to be presented in the dealer showroom without the cooling system being switched on. Do not activate this setting for domestic use.

## Selecting additional settings

If Demo mode has been switched on as a default setting,  will show on the display when the refrigeration appliance is switched on.

- Touch the *OK* sensor control on the control panel.



Miele will appear initially in the display, followed by the start screen.

- Touch *OK*.
- In Settings mode , use the < or > sensor control to scroll to the  symbol.
- Touch *OK*.

After Demo mode  has been switched off, the refrigeration appliance shuts down and must be switched on again.

### Resetting the settings to their factory default settings

All settings made on the refrigeration appliance will be reset to the factory default settings (for settings, see “Guide to the appliance”).

- In Settings mode , use the < or > sensor control to scroll to the  symbol.
- Touch *OK*.
- Use the > sensor control to scroll to the  symbol.
- Touch *OK*.

The refrigeration appliance shuts down and must be switched on again.



### Information

Appliance data (model number and serial number) is shown on the display.

Keep this appliance data to hand; you will need it:



- when integrating the refrigeration appliance into your Wi-Fi network (see “Selecting additional settings – Miele@home”) (depending on the model)
- when reporting an appliance fault to Miele Service (see “Customer Service”)



### Carbon-filter change indicator

After inserting the carbon filter (optional accessory), you must activate the carbon-filter change indicator  in Settings mode .

The carbon-filter change indicator  on the status display will remind you to replace the carbon filter approx. every 6 months (see “Cleaning and care – Replacing the carbon filters”).

### Cleaning mode

Cleaning mode  makes it easier to clean the refrigerator section (see “Cleaning and care”). The interior lighting remains switched on, even though the refrigerator section is switched off. The audible signal will stop and the symbols on the display will also go out. If Cleaning mode  is switched on, this will be indicated on the status display.

After cleaning, Cleaning mode  must be switched off. If the appliance door is closed for more than 10 minutes, Cleaning mode  switches itself off automatically.

 **WARNING! DANGER** of electric shock!  
Unplug the appliance or trip the circuit breaker.

 **WARNING! Fire hazard!**  
Do not damage the coolant pipework.

The data plate located inside the interior cabinet of the refrigeration appliance must not be removed. The data plate contains information which is required in the event of a fault.

Do not let water get into the electronic or the lighting.

 Risk of damage due to moisture penetration.  
The steam from a steam cleaner can damage plastic and electrical components.  
Do not use a steam cleaner to clean the refrigeration appliance.

## Defrosting

 **WARNING! DANGER** of injury and damage!  
Do not use any mechanical or other types of aids which are not recommended by the manufacturer to accelerate the defrosting process.

## Fridge zone and DailyFresh drawer

The fridge zone and the DailyFresh drawer defrost automatically.

## Freezer section

The appliance is equipped with a “NoFrost” system. The freezer defrosts automatically.

The moisture generated in the appliance collects on the condenser and is automatically defrosted and evaporates periodically.

This automatic defrosting system enables the Freezer Zone to remain permanently ice-free. However, the food stored in the freezer will not defrost.

## Cleaning agents

Cleaning and care products used in the interior cabinet of the refrigeration appliance must be food safe.

To avoid damaging the surfaces of your appliance, **do not** use the following:

- cleaning agents containing soda, ammonia, acids, or chloride
- cleaning agents containing limescale remover
- abrasive cleaning agents, such as scouring powder, scouring liquid, or pumice stones
- cleaning agents containing solvents
- stainless steel cleaners
- dishwasher cleaning agents
- oven sprays
- glass cleaners
- hard, abrasive sponges and brushes, such as pot scrubbers
- eraser sponges
- sharp metal scrapers

We recommend using a clean sponge, lukewarm water with a little liquid dish soap to clean the surfaces of the appliance.

# Cleaning and care

---

## Preparing the refrigeration appliance for cleaning

### Cleaning the fridge zone only:

Use the cleaning mode .

- Take any food out of the fridge zone and store it in a cool place.
- If necessary, take out all removable parts for cleaning.

### Cleaning the freezer zone/the entire refrigeration appliance:

- Turn the refrigeration appliance off.

The  symbol appears on the display and the cooling system is switched off.

- Take any food out of the freezer zone/ refrigeration appliance and store it in a cool place.
- If necessary, take out all removable parts for cleaning.

## Cleaning the interior of the appliance

Clean the appliance regularly, or at least once a month.

If soiling is left on for any length of time, it may become impossible to remove under certain circumstances. Surfaces may become discolored or damaged. It is therefore best to remove any soiling immediately.

- Clean the **interior** with a clean sponge, lukewarm water, and a little liquid dish soap.
- After cleaning, wipe with clean water and dry with a cleaning cloth.

- Clean the condensate channel and drain hole using a cotton swab or similar item.
- Leave the door open to air the refrigeration appliance sufficiently for a short while and to prevent odor build-up.

## Cleaning accessories by hand or in the dishwasher

The following components must be cleaned **by hand** only:

- the stainless-steel trim
- shelf with printing
- Flexible bottle rack
- the glass shelf (due to the printing on it)
- all drawers and compartment lids (these vary depending on model)
- organization box (available as an optional accessory)

The following components are **dishwasher-safe**:

 Risk of damage due to high dishwasher temperatures.

Parts of the refrigeration appliance may become unusable, e.g., deform, if they are washed in the dishwasher at more than 130°F (55°C).

For dishwasher-safe components, always select dishwasher programs with a maximum temperature of 130°F (55°C).

Contact with natural dyes from carrots, tomatoes, and ketchup, etc., may discolor the plastic parts in the dishwasher. This discoloration does not affect the stability of the parts.

- the bottle holder, egg tray, ice cube tray
- the door and bottle shelves in the appliance door (without stainless-steel trim)
- the adjustable shelves (without the strips or printing)

- the glass shelves (without protective strips)
- adapters for the split shelf
- the holder for the carbon filter (available as an optional accessory)

## Removing, dismantling, and cleaning accessories

### Dismantling the door shelf/bottle shelf

Remove the stainless-steel trim before cleaning the door shelf/bottle shelf in the dishwasher.

To remove the stainless-steel trim, proceed as follows:

- Place the door shelf/bottle shelf on the countertop.
- Pull the trim off the shelf beginning at one side.
- After cleaning the door shelf/bottle shelf, reattach the trim.

### Dismantling an adjustable shelf

Remove the trim before cleaning the adjustable shelf. Proceed as follows:

- Place the shelf on a countertop covered with a soft material (e.g., a dish towel).

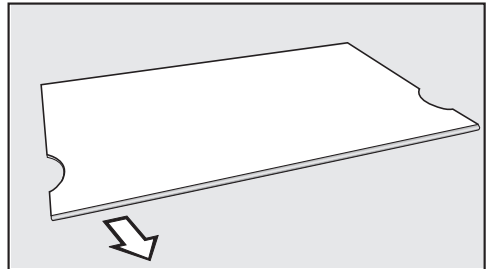

- Pull the trim off the shelf beginning at one side.
- After cleaning the shelf, reattach the trim.

# Cleaning and care

## Dismantling a split shelf

Remove the trim before cleaning the adjustable shelf. Proceed as follows:

- Place the shelf on a countertop covered with a soft material (e.g., a dish towel).
- Pull the trim off the shelf beginning at one side.
- Pull the two adapters off the support ribs on the left and right.
- After cleaning, attach the two adapters to the support ribs on the left and right at the desired height.
- Reattach the trim to the shelf.

## Removing the drawers from the fridge zone

- Pull the drawer halfway out.

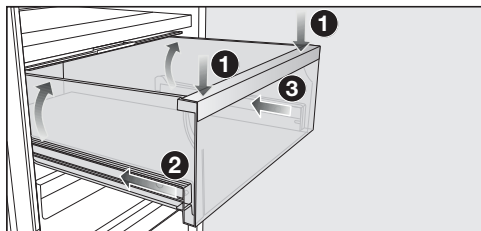

- Push the drawer down at the front **1** until it lifts up at the back. Keep pushing the drawer down.
- Now carefully insert the left **2** and then the right **3** runner by approx. 2 cm.

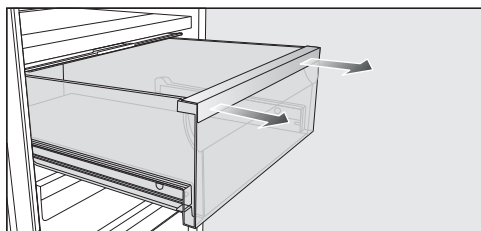

- Using both hands, pull the drawer firmly forward.

Push the telescopic runners back in again to avoid damaging them.

## Inserting the drawers

- Place the drawer on the fully retracted telescopic runners.
- Push the drawer into the appliance until it clicks into position.

## Removing the compartment lid

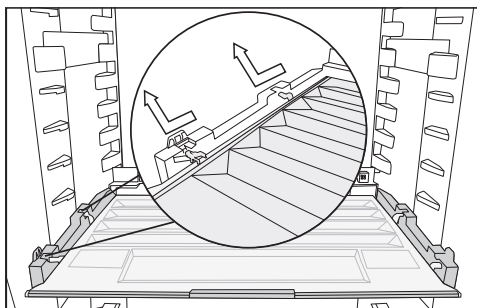

- Lift the lid at the front and pull it out.
- After cleaning, slide the compartment lid back in again.

## Removing the drawers and glass plates from the freezer zone

- Lift the drawer up slightly at the front and pull it out.
- Pull the glass plate forward a little and out.

## Inserting the glass plates and drawers into the freezer zone

- Place the glass plate on the guide rails at an angle.
- Push in and lower the glass plate.
- Place the drawer on the guide rails at an angle.
- Push in and lower the drawer.

### Replacing an Active AirClean filter (charcoal filter)

Active AirClean filters can be obtained from Miele Service or specialty dealers, or via the Miele website.

- Pull the charcoal filter holder upward to remove it from the adjustable shelf.

When in position, the carbon filters must not touch the back wall of the refrigeration appliance, as the moisture could cause them to stick to it. Insert the new carbon filters deep enough in the holder to ensure that they do not protrude over the edge of the holder.

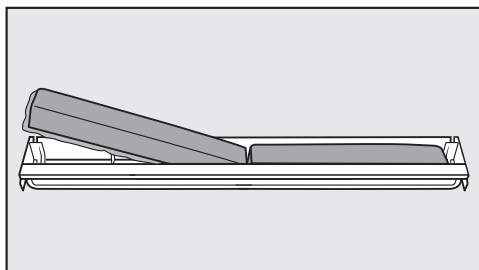

- Remove both charcoal filters and place the new filters with the surrounding edge pointing downward in the holder.

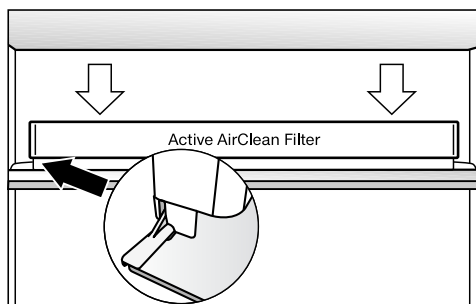

- Place the holder in the middle of the protective strip at the back of any adjustable shelf so that it clicks into position.

### Confirming that the Active AirClean filter has been changed

- Touch *OK*.

The  symbol will go out and the counter will be reset.

### Cleaning the machine front and the side panels

If soiling is allowed to sit for any length of time, it may become impossible to remove. Surfaces may become discolored or damaged. It is therefore best to remove soiling from the appliance front and side panels immediately.

All surfaces are easily scratched. Contact with unsuitable cleaning agents can alter or discolor the surfaces.

See the information on “Cleaning agents” at the beginning of this section.

## Cleaning and care

---

- Clean the surfaces with a clean sponge and a solution of warm water and liquid dish soap. A clean, damp microfiber cloth without cleaning agent can also be used for cleaning.
- After cleaning, wipe with clean water and dry with a soft cloth.

### Clean Touch Steel (edt/cs) – appliance front

 Risk of damage as a result of incorrect cleaning.  
The surface coating will be damaged.  
**Do not use a stainless steel cleaner** on this surface.

The appliance front has a high quality, special finish. This is resistant to soiling and is very easy to clean.

### Cleaning the door seal





 Risk of damage as a result of incorrect cleaning.  
If you treat the door seal with oils or grease, it can become porous.  
Do not use any oils or grease on the door seal.

- The door seals should be cleaned regularly with clean water, and then wiped dry with a soft cloth.

### Cleaning the ventilation openings

- The ventilation openings should be cleaned on a regular basis with a feather duster or vacuum cleaner (you could use a Miele vacuum cleaner dusting brush, for example).

### After cleaning

- Place all shelves and accessories back in the refrigeration appliance.
- Switch the refrigeration appliance back on, if necessary.
- Switch the fridge zone cleaning mode  off again, if necessary.
- Switch the SuperFreeze function  on for a while so that the freezer zone can cool down quickly.
- Switch the SuperCool function  on for a while so that the fridge zone can cool down quickly.
- Place food in the fridge zone.
- Once the temperature in the freezer zone is cold enough, you can place the food in the freezer zone and return the drawers to the freezer.
- Switch the SuperCool function  off once food and drinks are sufficiently chilled.
- Switch off the SuperFreeze function  as soon as the temperature in the freezer zone is a constant 0°F (-18°C) or colder.
- Close the appliance doors.

## Frequently asked questions

Many malfunctions and faults can be easily remedied. You can save time and money in many cases, as you do not need to contact Miele Service.

More information to help you rectify faults yourself can be found at <https://www.mieleusa.com/support/customer-assistance>.



To prevent cold from escaping, open the appliance doors as little as possible until the fault has been corrected.





### Other problems

Problem	Possible cause and solution
<b>The refrigeration appliance is not cooling.</b>	The refrigeration appliance has not been turned on. ■ Turn the refrigeration appliance on.
	The electrical plug is not inserted in the socket correctly or the plug connector is not inserted into the socket at the back of the machine correctly. ■ Insert the electrical plug into the socket and the plug connector into the machine socket.
	The circuit breaker has tripped. There could be a fault with the refrigeration appliance, the household electrical wiring, or another appliance. ■ Contact a qualified electrician or Miele Service.
<b>The compressor runs continuously.</b>	This is not a fault. To save energy, the compressor runs at a lower speed when less cooling is required. This increases the compressor run time.
<b>The compressor is turning on more frequently and for longer periods of time; the temperature in the refrigeration appliance is too low.</b>	The appliance doors have been opened too frequently. Or large amounts of fresh food have been placed in the appliance. ■ Only open the appliance doors when necessary and for as short a time as possible.
	The appliance doors are not closing fully. The temperature in the refrigeration appliance is dropping. ■ Check that the appliance doors are seated correctly and use the screws in the hinges to adjust them if necessary.
	The appliance doors are not closed properly. If a thick layer of ice has already formed, this will affect cooling and increase energy consumption.

## Frequently asked questions











Problem	Possible cause and solution
	<ul style="list-style-type: none"> <li>■ Always close the appliance doors fully.</li> <li>■ Defrost the refrigeration appliance if necessary and clean it.</li> </ul> <p>The ambient temperature is too high. The higher the ambient temperature, the longer the compressor runs.</p> <ul style="list-style-type: none"> <li>■ See the information in “Installation – Installation site”.</li> </ul> <p>The ventilation openings are obstructed or dusty.</p> <ul style="list-style-type: none"> <li>■ Do not block the ventilation openings.</li> <li>■ Clean the ventilation openings on a regular basis to remove any dust.</li> </ul> <p>Built-in appliances: The refrigeration appliance was not properly installed in the niche.</p> <ul style="list-style-type: none"> <li>■ Install the refrigeration appliance in the niche as described in the installation instructions.</li> </ul>
<p><b>The temperature in the refrigeration appliance is too low.</b></p>	<p>The temperature setting in the refrigeration appliance is too low.</p> <ul style="list-style-type: none"> <li>■ Correct the temperature setting.</li> </ul> <p>A large amount of food was put in for freezing all at once.</p> <ul style="list-style-type: none"> <li>■ Refer to the instructions in “Operation – Freezing and storing fresh food”.</li> </ul> <p>The SuperCool function ❄️ is still switched on.</p> <ul style="list-style-type: none"> <li>■ Switch off the SuperCool function ❄️ earlier to save energy.</li> </ul> <p>The SuperFreeze function ❄️ is still switched on.</p> <ul style="list-style-type: none"> <li>■ Switch off the SuperFreeze function ❄️ earlier to save energy.</li> </ul>

## Frequently asked questions





Problem	Possible cause and solution
<p><b>The temperature in the refrigeration appliance is too high. The frozen food (depending on the model) could defrost.</b></p>	<p>This is not a fault. The temperature setting is too high.</p> <ul style="list-style-type: none"> <li>■ Correct the temperature setting.</li> <li>■ Check the temperature again after 24 hours.</li> </ul> <p>The ambient temperature is too low for this refrigeration appliance. If the ambient temperature is too low, the compressor will run less frequently. The temperature in the refrigeration appliance rises.</p> <ul style="list-style-type: none"> <li>■ See the information in “Installation – Installation site”.</li> <li>■ Increase the ambient temperature.</li> </ul>
<p><b>Ice or condensation has built up inside the refrigeration appliance. The appliance door may not close correctly.</b></p>	<p>The door seal has come out of its groove.</p> <ul style="list-style-type: none"> <li>■ Check that the door seal is correctly positioned in the groove.</li> </ul> <p>The door seal is damaged.</p> <ul style="list-style-type: none"> <li>■ Check whether the door seal is damaged.</li> </ul>
<p><b>The door seal is damaged or needs to be replaced.</b></p>	<p>No tools are required to change the door seal.</p> <ul style="list-style-type: none"> <li>■ Change the door seal. A replacement is available from Technical Service.</li> </ul>
<p><b>Food has frozen together or to the wall.</b></p>	<p>The food packaging was not dry when loaded in the freezer.</p> <ul style="list-style-type: none"> <li>■ Use a blunt instrument (such as a spoon handle) to carefully pry them apart.</li> </ul>
<p><b>An alarm does not sound even though the appliance door has been open for a long time.</b></p>	<p>This is not a fault. The alarm has been switched off in Settings mode. If you want to switch the audible alarm back on again:</p> <ul style="list-style-type: none"> <li>■ Touch <i>OK</i>.</li> <li>■  appears on the display.</li> <li>■ Use the &lt; or &gt; sensor control to scroll to the  symbol.</li> <li>■ Touch <i>OK</i>.</li> <li>■ Use the &lt; or &gt; sensor control to scroll to the  symbol.</li> <li>■ Touch <i>OK</i>.</li> <li>■ Use the &lt; and &gt; sensor controls to select the volume you want for alarms and audible signals.</li> <li>■ Touch <i>OK</i>.</li> </ul> <p>When the alarms and audible signals are switched on,  will appear.</p>

# Frequently asked questions



## Messages in the display

Message	Possible cause and solution
<p><b>■ lights up on the display, the refrigeration appliance does not get cold even though the controls and the interior lighting are working.</b></p>	<p>Demo mode has been activated.</p> <ul style="list-style-type: none"> <li>■ Touch <i>OK</i>.</li> </ul> <p>Miele will appear initially in the display, followed by the start screen.</p> <ul style="list-style-type: none"> <li>■ Touch <i>OK</i>.</li> <li>■ In Settings mode , use the &lt; or &gt; sensor control to scroll to the ■ symbol.</li> <li>■ Touch <i>OK</i>.</li> </ul> <p>After Demo mode ■ has been switched off, the refrigeration appliance shuts down and must be switched on again.</p>
<p><b> is lit up on the display and the refrigeration appliance cannot be used.</b></p>	<p>Cleaning mode is still switched on.</p> <ul style="list-style-type: none"> <li>■ Touch the <i>OK</i> sensor control on the control panel to switch off Cleaning mode.</li> </ul> <p> will appear in the display.</p> <ul style="list-style-type: none"> <li>■ Touch <i>OK</i>.</li> </ul> <p>When Cleaning mode  is switched off, the dot in the upper corner of the display goes out.</p> <ul style="list-style-type: none"> <li>■ Use the &lt; or &gt; sensor control to scroll to the  symbol and touch <i>OK</i>.</li> </ul> <p>The refrigeration appliance will start cooling again.</p>
<p><b>Nothing is visible on the display. The display is completely blank.</b></p>	<p>Sabbath mode  is switched on: the interior lighting is switched off and the appliance is cooling.</p> <ul style="list-style-type: none"> <li>■ Touch <i>OK</i>.</li> </ul> <p> will appear in the display.</p> <ul style="list-style-type: none"> <li>■ Touch <i>OK</i>.</li> </ul> <p>When the Sabbath-mode function  is switched on, a dot appears in the upper corner of the display •.</p> <ul style="list-style-type: none"> <li>■ Touch <i>OK</i>.</li> </ul> <p>When the Sabbath-mode function  is switched off, the dot in the upper corner of the display goes out.</p>
<p><b>The  symbol is lit up on the display and the refrigeration appliance cannot be used.</b></p>	<p>The lock function has been activated.</p> <ul style="list-style-type: none"> <li>■ Unlock the refrigeration appliance temporarily or switch the lock function off completely.</li> </ul>



## Frequently asked questions

Message	Possible cause and solution
<p>The  symbol lights up on the status display and an audible signal also sounds.</p>	<p>The carbon-filter change indicator  reminds you that the carbon filter needs to be changed.</p> <ul style="list-style-type: none"> <li>■ Replace the carbon filter in the holder (see “Cleaning and care – Replacing the carbon filters (optional accessory)”) and confirm that the carbon filter has been replaced by touching the <i>OK</i> sensor control.</li> </ul> <p>The  symbol will go out on the status display.</p>
<p> lights up in one of the temperature displays, an alarm sounds, and the interior lighting is flashing.</p>	<p>The <b>door alarm</b> has been activated.</p> <ul style="list-style-type: none"> <li>■ Touch <i>OK</i>.</li> </ul> <p>The alarm will stop, the  symbol will go out, and the interior lighting will light up again constantly.</p> <ul style="list-style-type: none"> <li>■ Close the relevant appliance door.</li> </ul>



## Frequently asked questions

Message	Possible cause and solution
<p> lights up on the temperature display for the freezer zone and an alarm also sounds.</p>	<p>The <b>temperature alarm</b> has been activated; the temperature in the freezer zone has risen higher or fallen lower than the temperature set.</p> <p>Possible reasons for this include:</p> <ul style="list-style-type: none"> <li>– The appliance door has been opened too frequently.</li> <li>– A large quantity of fresh food has been placed in the freezer without switching on the Super-Freeze function.</li> <li>– A prolonged power outage has occurred.</li> <li>– The refrigeration appliance has a fault.</li> </ul> <p>■ Touch <i>OK</i>.</p> <p>The alarm message is confirmed:  goes out and the alarm stops.</p> <p>The warmest temperature recorded in the freezer zone will flash for about 1 minute on the display. Then the temperature display will change to the current temperature in the freezer zone.</p> <p>You can exit from the flashing temperature display early:</p> <p>■ Touch <i>OK</i>.</p> <p>The warmest temperature display will disappear. The display will then revert to showing the current temperature in the freezer zone.</p> <p>■ Rectify the cause of the alarm.</p> <p>■ Depending on the temperature displayed, you should check whether food in the freezer has started to thaw or has defrosted. If it has, cook it before freezing it again.</p>

## Frequently asked questions

Message	Possible cause and solution
<p> lights up on the display and an alarm also sounds.</p>	<p>Indication of a power outage: The temperature in the freezer zone over the last few days or hours has risen too high because of a power outage or interruption to the power supply.</p> <ul style="list-style-type: none"> <li>■ Touch <i>OK</i>.</li> </ul> <p>The fault message is confirmed:   goes out and the alarm stops.</p> <p>The warmest temperature recorded in the freezer zone will flash for about 1 minute on the temperature display for the freezer zone. Then the temperature display will change to the current temperature in the freezer zone.</p> <p>You can exit from the flashing temperature display early:</p> <ul style="list-style-type: none"> <li>■ Touch <i>OK</i>.</li> </ul> <p>The warmest temperature display will disappear. The display will then revert to showing the current temperature in the freezer zone. The refrigeration appliance will go back to the last temperature setting when the power is restored.</p> <ul style="list-style-type: none"> <li>■ Rectify the cause of the alarm.</li> <li>■ Depending on the temperature displayed, you should check whether food in the freezer has started to thaw or has defrosted. If it has, cook it before freezing it again.</li> </ul>





## Frequently asked questions

Message	Possible cause and solution
<p><b>⚠ lights up in the display and a fault code F with numbers may appear. An alarm is also sounding.</b></p>	<p>A fault has occurred.</p> <ul style="list-style-type: none"><li>■ Switch the alarm off by touching <i>OK</i>.</li><li>■ Contact Miele Service.</li></ul> <p>To report the fault, you need the fault code and also the model number and serial number of your refrigeration appliance. You can access this information <b>i</b> on the display:</p> <ul style="list-style-type: none"><li>■ Touch <i>OK</i>.</li></ul> <p>The appliance data required will be shown on the display.</p> <ul style="list-style-type: none"><li>■ Touch <i>OK</i>.</li><li>■ To switch off the refrigeration appliance, use the &lt; or &gt; sensor control to scroll to the  symbol.</li><li>■ To exit the information display, use the &lt; or &gt; sensor control to scroll to the  symbol.</li><li>■ Touch <i>OK</i>.</li></ul> <hr/> <p>There is an appliance fault: This display always has priority over any settings which have just been selected.</p> <p>An appliance fault has priority over any current door and/or temperature alarms displayed.</p>

### Interior lighting

 Risk of electric shock due to exposed, live electrical components.  
When removing the lighting cover, there is a risk of coming into contact with live electrical components.  
Do not remove the lighting cover. The LED lighting may only be repaired or replaced by Customer Service.

 Risk of injury from LED lighting.  
This lighting corresponds to risk group RG 2. If the cover is defective, there is a risk of eye injury.  
If the lighting cover is defective, do not look from a close range directly into the lighting with optical instruments (e.g., magnifying glass or similar).

Problem	Possible cause and solution
<p><b>The interior lighting is not working.</b></p>	<p>The refrigeration appliance has not been turned on. ■ Turn the refrigeration appliance on.</p>
	<p>Sabbath mode  is switched on: the display is dark and the refrigeration appliance is cooling. ■ Touch <i>OK</i>.  will appear in the display. ■ Touch <i>OK</i>.</p>
	<p>When the Sabbath-mode function  is switched on, a dot appears in the upper corner of the display •. ■ Touch <i>OK</i>.</p>
	<p>When the Sabbath-mode function  is switched off, the dot in the upper corner of the display goes out.</p> <p>To avoid overheating, the interior lighting switches itself off automatically after approximately 15 minutes if the appliance door is left open. If this is not the cause, there is a fault. ■ Contact Miele Customer Service.</p>
<p><b>The interior lighting is pulsating.</b></p>	<p>This is not a fault. The door alarm has been activated.</p>

# Frequently asked questions

---

## Causes of noises

The refrigeration appliance is producing various noises during operation. If the cooling performance is low, the refrigeration appliance will conserve energy but operate for longer. The volume will be lower. Food will be chilled faster if the cooling performance is high. The volume will be higher.

<b>Normal noises</b>	<b>What is causing the noises?</b>
<b>Hissing</b>	Refrigerant is being injected into the cooling circuit.
<b>Bubbling, gurgling, splashing</b>	Refrigerant is circulating through the pipes.
<b>Humming</b>	The refrigeration appliance is cooling.
<b>Clicking</b>	The thermostat is switching the compressor on or off.
<b>Humming, whirring</b>	The fan is running. The automatic door opener (depending on the model) is opening or closing the appliance door.
<b>Cracking</b>	Material in the refrigeration appliance is expanding.
<b>Rattling</b>	Valves or flaps are active.
<b>Buzzing (refrigeration appliances with water container)</b>	Water is being pumped out of the water container.
<b>Slurping (refrigeration appliances with soft-close mechanism)</b>	The appliance door with soft-close mechanism is being opened or closed.

Please keep in mind that a certain amount of noise is unavoidable (from the compressor and the refrigerant circulating through the cooling circuit).

## Frequently asked questions

Noises	Cause and solution
<b>Vibrating, rattling, clinking</b>	The refrigeration appliance is uneven. Use a level to check and adjust the alignment of the refrigeration appliance. The refrigeration appliance is aligned by raising or lowering the adjustable feet (depending on the model) underneath it.  <b>For built-in appliances:</b> For niches of 55 1/8" (140 cm) and more: place the stabilizing rods supplied underneath the appliance base.
	The refrigeration appliance is touching another appliance or piece of furniture. Move it away.
	Drawers, baskets, or shelves are jiggling or are stuck. Check all removable items and reinsert them correctly.
	Bottles or containers are touching each other. Separate bottles or containers slightly.
	The transport cable clips (depending on the model) are hanging loose at the back of the appliance. Remove the transport cable clips.

## Customer Service

---

Information to help you rectify faults yourself and about Miele spare parts can be found at [www.miele.com/service](http://www.miele.com/service).

### Contact in the event of a fault

In the event of a fault which you cannot remedy yourself, please contact your Miele dealer or Miele Customer Service.

You can book a Miele Customer Service call online at [www.miele.com/service](http://www.miele.com/service).

Contact information for Miele Customer Service can be found at the end of this document.

Please quote the model identifier and serial number of your appliance (SN) when contacting Miele Customer Service. Both numbers can be found on the data plate inside the refrigeration appliance or, depending on the model, in Settings mode under Information **i**.

You will find the data plate inside your appliance.

### Appliance warranty and product registration

You can register your product and/or view the manufacturer's warranty terms and conditions for Miele appliances and vacuum cleaners at [www.mieleusa.com](http://www.mieleusa.com).

Frequency range	2.412 GHz – 2.462 GHz
Maximum transmitting power	< 100 mW

## Copyrights and licenses

For the purpose of operating and controlling the communication module, Miele uses proprietary or third-party software that is not covered by open source licensing terms. This software/these software components are protected by copyright. The copyrights held by Miele and third parties must be respected.

In addition, the integrated communication module contains software components which are distributed under open source licensing terms. You can access these open source components along with the associated copyright notices, copies of the valid licensing terms, and any additional information locally via IP using a web browser ([http\[s\]://<ip address>/Licenses](http[s]://<ip address>/Licenses)). The liability and warranty arrangements for the open source licenses displayed in this location only apply in relation to the respective rights holders.



Please have the model and serial number of your appliance available when contacting Customer Service.

---

## **U.S.A.**

**Miele, Inc.**

### **National Headquarters**

9 Independence Way  
Princeton, NJ 08540  
[www.mieleusa.com](http://www.mieleusa.com)

### **Customer Support**

Phone: 888-99-MIELE (64353)  
[info@mieleusa.com](mailto:info@mieleusa.com)

### **International Headquarters**

Miele & Cie. KG  
Carl-Miele-Straße 29  
33332 Gütersloh  
Germany

## **Canada**

**Importer  
Miele Limited**

### **Headquarters and Miele Centre**

161 Four Valley Drive  
Vaughan, ON L4K 4V8  
[www.miele.ca](http://www.miele.ca)

### **Customer Care Centre**

Phone: 1-800-565-6435  
905-532-2272  
[contact@miele-support.ca](mailto:contact@miele-support.ca)

KFN 4776 ...

en-US

M.-Nr. 12 090 320 / 09 / 002