

Operating and installation instructions Rangehood



To prevent the risk of accidents or damage to the appliance, it is **essential** to read these instructions before it is installed and used for the first time.

Contents

Warning and Safety instructions	4
Caring for the environment	10
Description of the functions	11
Guide to the rangehood	12
Before using for the first time	14
Setting up Miele@home	14
Performing Scan & Connect	14
Signing out of Wi-Fi (reset to factory settings)	15
Setting up Con@ctivity	15
Con@ctivity via the home Wi-Fi network (Con@ctivity 3.0)	16
Con@ctivity via a direct Wi-Fi connection (Con@ctivity 3.0)	16
Reattempting the connection	16
Operation (automatic mode)	17
Cooking with Con@ctivity (automatic mode)	17
Cooking process	17
Leaving automatic mode temporarily	18
Returning to automatic mode	18
Operation (manual mode)	19
Cooking without Con@ctivity (manual mode)	19
Switching the fan on	19
Selecting a power level	19
Selecting the run-on time	19
Switching the fan off	19
Dimming/switching the cooktop lighting on/off	20
Power management	20
Safety switch-off	20
Operation (automatic and manual modes)	21
Operating hours counter	21
Altering the grease filter operating hours counter	21
Altering the charcoal filter operating hours counter	22
Reading the filter operating hours counter	22
Energy saving tips	23
Cleaning and care	24
Housing	24
Important information for appliances with stainless steel surfaces	24
Important for appliances with lacquered casing	24
Grease filters	24
Resetting the grease filter operating hours counter	26
Change grease filters	26

Contents

NoSmell active charcoal filters.....	27
Resetting the charcoal filter operating hours counter.....	27
Disposing of the charcoal filters.....	27
Reactivatable charcoal filters.....	27
Service.....	28
Contact in case of fault.....	28
Position of the data plate.....	28
Warranty.....	28
Installation.....	29
Before installation.....	29
Assembly parts.....	29
Installation instructions.....	29
Appliance dimensions.....	30
Safety distance (S).....	31
Installation recommendations.....	32
Electrical connection.....	33
Technical data.....	34
Optional accessory for recirculation mode.....	34

Warning and Safety instructions

This rangehood complies with all relevant local and national safety requirements. However, inappropriate use can lead to personal injury and damage to property.

Read the operating and installation instructions carefully before using the rangehood. They contain important information on the safety, installation, use and maintenance of the appliance. This prevents both personal injury and damage to the rangehood.

In accordance with standard IEC 60335-1, Miele expressly and strongly advises that you read and follow the instructions in “Installation” and in the “Warning and Safety instructions”.

Miele cannot be held liable for injury or damage caused by non-compliance with these instructions.

Keep these instructions in a safe place and pass them on to any future owner.

Correct application

► This rangehood is designed for domestic use and for use in similar environments by guests in hotel or motel rooms, bed & breakfasts and other typical living quarters. This does not include common/shared facilities or commercial facilities within hotels, motels or bed & breakfasts.

► The appliance is not suitable for outdoor use.

► It must only be used to extract vapours and remove odours from cooking.

Any other usage is at the owner's risk. Miele cannot be held liable for damage resulting from incorrect or improper use or operation.

► The rangehood cannot be used to ventilate the room in which it is installed in recirculation mode above a gas cooktop. Please seek the advice of a qualified gas fitter for more information if necessary.

► This appliance is not intended for use by persons (including children) with reduced physical, sensory or mental capabilities, or lack of experience and knowledge, unless they have been given supervision or instruction concerning its use by a person responsible for their safety, and are able to recognise the dangers of misuse.

Safety with children

- ▶ Young children must not be allowed to use the rangehood.
- ▶ Older children may only use the rangehood if its operation has been clearly explained to them and they are able to use it safely. They must be able to understand and recognise the possible dangers caused by incorrect operation.
- ▶ Cleaning work may only be carried out by older children under the supervision of an adult.
- ▶ Children should be supervised near the appliance. Ensure that they do not play with the appliance.
- ▶ The cooktop lighting is very intense. Ensure, in particular, that babies/small children do not look directly at the light.
- ▶ Danger of suffocation! Whilst playing, children may become entangled in packaging material (such as plastic wrapping) or pull it over their head with the risk of suffocation. Keep packaging material away from children.

Technical safety

- ▶ Unauthorised installation, maintenance and repairs (including removal of any cover) can cause considerable danger for the user. Installation must be performed by a suitably qualified and competent person. Maintenance and repairs must only be carried out by a Miele authorised technician.
- ▶ A damaged appliance can be dangerous. Check it for visible signs of damage. Do not use a damaged appliance.
- ▶ The electrical safety of this appliance can only be guaranteed when continuity is complete between it and an effective earthing system. It is most important that this basic safety requirement is present and tested regularly and, where there is any doubt, the household wiring system should be inspected by a qualified electrician.

Warning and Safety instructions

▶ Temporary or permanent operation with a self-sufficient or non-mains synchronous energy supply system (e.g. isolated networks, back-up systems) is possible. A requirement for the operation is that the energy supply system complies with all current local and national requirements that apply to stand-alone, solar and/or battery systems. The protective measures provided in the installation and in this Miele product must also be assured in their function and operation in isolated operation or in non-mains synchronous operation, or replaced with equivalent measures in the installation.

▶ The connection data (voltage and frequency) on the data plate of the rangehood must match the mains electricity supply in order to avoid the risk of damage to the rangehood.

Compare this before connecting the appliance to the mains electricity. If in doubt, consult a qualified electrician.

▶ Do not connect the appliance to the mains electricity supply by a multi-socket unit or an extension lead. Extension leads are a fire hazard and do not guarantee the required safety of the appliance.

▶ For safety reasons, this appliance may only be used after it has been built in.

▶ This rangehood must not be installed and operated in mobile installations (e.g. on a ship).

▶ Tampering with electrical connections or components and mechanical parts is highly dangerous to the user and can cause operational faults.

Only open the housing as described in the instructions given in the installation sheet and in the “Cleaning and care” section of this booklet. Under no circumstances should any other parts of the housing be opened.

▶ The manufacturer's warranty will be invalidated if the appliance is not repaired by a Miele authorised service technician.

▶ Do not pull on the mains connection cable. It must not be used for securing other components (such as a shelf).

▶ If the mains connection cable is damaged, it must only be replaced by a Miele authorised service technician or suitably qualified and competent electrician in order to avoid a hazard.

▶ The lamps are a built-in component of the lighting. Replacement lamps may only be installed by a Miele authorised technician.

Warning and Safety instructions

▶ During installation, maintenance and repair work, the appliance must be disconnected from the mains electricity supply. It is only completely isolated from the electricity supply when:

- the mains circuit breaker is switched off, or
- it is switched off at the wall socket and the plug is withdrawn from the socket. Do not pull the mains connection cable but the mains plug to disconnect your appliance from the mains electricity supply.

Correct use

▶ Open flames are a fire hazard!

Never use an open flame under the rangehood. To avoid the danger of fire, do not flambé or grill over an open flame. When switched on, the rangehood could draw flames into the filter. Kitchen grease deposits could ignite.

▶ The rangehood can become damaged when exposed to excessive heat.

- When using the rangehood over a gas cooktop, ensure that any burners in use are always covered by a pan. Switch the cooking zone off when a pan is removed, even for a short time.
- Select a pan which is suitable for the size of the burner.
- Regulate the flame so that it does not burn up the sides of the pan.
- Avoid overheating the pan (e.g. when cooking with a wok).

▶ Always switch the rangehood on when a cooking zone is in use, otherwise condensation may collect in the rangehood, which could cause corrosion.

▶ Overheated oil and fat can ignite, causing fire damage to the rangehood.

When cooking with oil or fat, chip pans and deep fat fryers etc., do not leave the pans unattended. Similarly, never leave an open grill unattended when grilling.

▶ Do not use the rangehood without the filters in place. This way you will avoid the risk of grease and dirt getting into the appliance and hindering its smooth operation.

▶ The rangehood can get very hot during cooking due to heat rising from the cooktop.

Do not touch the housing or the grease filters until the rangehood has cooled down.

Warning and Safety instructions

Correct installation

- ▶ To determine whether a rangehood may be operated above your cooking appliance, please refer to the information provided by the appliance's manufacturer.
- ▶ Safety regulations prohibit the fitting of a rangehood over solid fuel stoves.
- ▶ An insufficient safety distance between the cooktop and the rangehood can result in damage to the rangehood. The minimum safety distances between the top of the cooktop and the bottom of the rangehood given in the "Installation" section of this booklet must be observed, unless the cooktop manufacturer states that a greater safety distance is required. If more than one cooking appliance is fitted beneath the rangehood, and they have different minimum safety distances to the rangehood, select the greater distance.
- ▶ The information provided in "Installation" must be observed when installing the rangehood.

Cleaning and care

- ▶ There is a risk of fire if cleaning is not carried out as described in these operating instructions.
- ▶ Do not use a steam cleaning appliance to clean this appliance. The steam could reach electrical components and cause a short circuit.
- ▶ In areas which may be subject to infestation by cockroaches or other vermin, pay particular attention to keeping the machine and its surroundings in a clean condition at all times. Any damage which may be caused by cockroaches or other vermin will not be covered by the machine warranty.

Accessories and spare parts

- ▶ Use only genuine original Miele spare parts. If spare parts or accessories from other manufacturers are used, the warranty will be invalidated, and Miele cannot accept liability.
- ▶ Faulty components must only be replaced by genuine Miele spare parts. The manufacturer can only guarantee the safety of the appliance when Miele replacement parts are used.
- ▶ Miele will guarantee to supply functional spare parts for a minimum of 10 years and up to 15 years following the discontinuation of your appliance.

Caring for the environment

Disposal of the packing material

The transport and protective packaging has been selected from materials which are environmentally friendly for disposal, and can normally be recycled.

Recycling the packaging reduces the use of raw materials in the manufacturing process and also reduces the amount of waste in landfill sites.

Ensure that any plastic wrappings, bags etc. are disposed of safely and kept out of the reach of babies and young children. Danger of suffocation.

Only for Australia: Note for installer: Expanded polystyrene (EPS) packaging included. Please retain and dispose of EPS packaging responsibly. For further information, please contact Miele.

Disposing of your old appliance

Electrical and electronic appliances often contain valuable materials. They also contain specific materials, compounds and components, which were essential for their correct function and safety. These could be hazardous to human health and to the environment if disposed of with your domestic waste or if handled incorrectly. Please do not, therefore, dispose of your old appliance with your household waste.



Please dispose of it at your local community waste collection / recycling centre for electrical and electronic appliances. You are also responsible for deleting any personal data that may be stored on the appliance prior to disposal. Please ensure that your old appliance poses no risk to children while being stored prior to disposal.

Recirculation mode

This rangehood operates solely in recirculation mode.

The air is drawn in and cleaned first by the grease filters and then by four charcoal filters. The cleaned air is then recirculated back into the kitchen through ventilation grilles in the top of the rangehood.

Guide to the rangehood

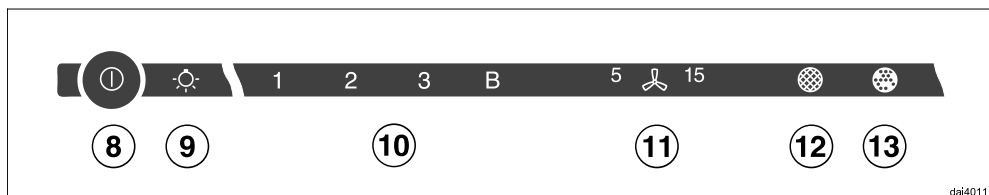
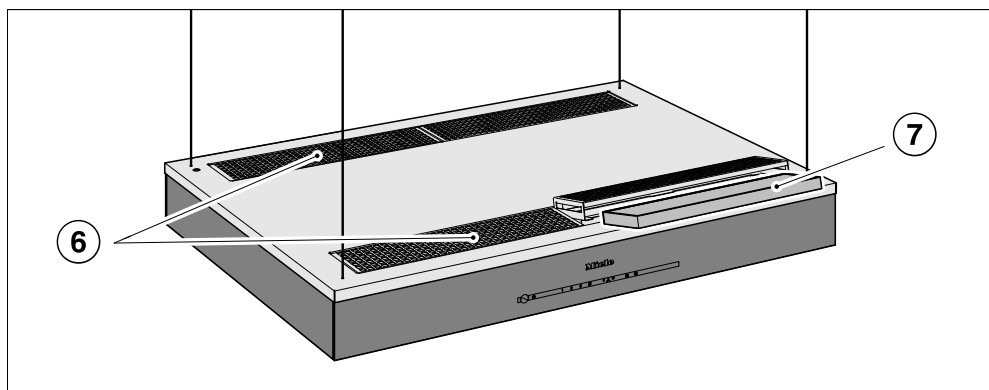
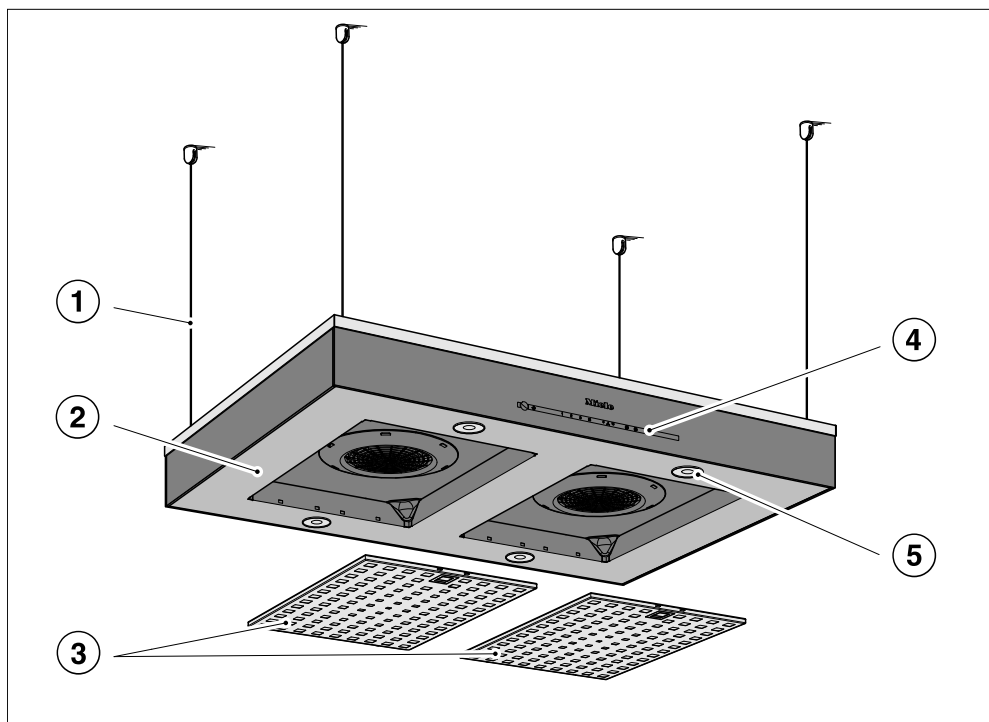

dai4011

- ① Suspension cables
- ② Canopy
- ③ Grease filter
- ④ Control panel
- ⑤ Cooktop lighting
- ⑥ Recirculation grilles
- ⑦ Charcoal filter
- ⑧ Touch control for switching the fan on and off
- ⑨ Sensor for switching the lighting on and off and for dimming the lighting
- ⑩ Touch controls for selecting the fan power level
- ⑪ Sensor for the run-on function
- ⑫ Sensor for the grease filter operating hours counter
- ⑬ Sensor for the charcoal filter operating hours counter

Before using for the first time

Setting up Miele@home

Prerequisites:

- a Wi-Fi network
- the Miele App
- a Miele user account. The user account can be created via the Miele App.

Your rangehood is equipped with an integrated Wi-Fi module. Connect the rangehood to your household Wi-Fi network. You will then be able to operate the rangehood via the Miele App.

If your Miele cooktop is connected to a home Wi-Fi network, you can control the rangehood automatically via the Con@ctivity function.

Before installing the rangehood in its final location, ensure that the signal of your Wi-Fi network is strong enough.

Miele@home availability

The ability to use the Miele App depends on the availability of the Miele@home service in your country.

The Miele@home service is not available in every country.

For information about availability, please visit www.miele.com.

Performing Scan & Connect

- Scan the QR code.

If you have installed the Miele App and have a user account, you will be taken directly to the networking steps.

If you have not yet installed the Miele App, you will be taken to the Apple App Store® or the Google Play Store™.

- Install the Miele App and set up a user account.
- Scan the QR code again.

The Miele App will guide you through the set-up process.



Signing out of Wi-Fi (reset to factory settings)

To set up a new Wi-Fi connection, the existing Wi-Fi connection must first be disconnected.

- Manually switch the rangehood off.



- Press and hold the **1** control.



- Touch the lighting control  at the same time.

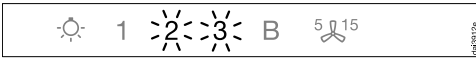

With an existing Wi-Fi connection **2** and **3** will light up constantly.

The rangehood is ready for disconnection during the next two minutes.



- Touch the **1** control.



2 will light up constantly, **3** will flash on and off.



After a few seconds **2** and **3** will flash on and off. The connection has now been disconnected.



- Quit disconnection mode on the rangehood by touching the run-on control .

The Wi-Fi connection has been disconnected. A new connection can now be set up.

Setting up Con@ctivity

Con@ctivity is the direct communication system between an electric Miele cooktop and a Miele rangehood. It enables the rangehood to operate automatically depending on the operational state of a Miele cooktop with onset controls.

- When the cooktop is switched on, the cooktop lighting on the rangehood comes on independently and, after a short time, the fan also switches on.
- The rangehood selects the power level automatically during cooking. The power level selected by the rangehood depends on the number of cooking zones being used and their power levels.
- After switching the cooktop off, the fan and the cooktop lighting will switch off automatically after a specified period of time.

See “Operation” for detailed information about this function.

Before using for the first time

Con@ctivity via the home Wi-Fi network (Con@ctivity 3.0)

Prerequisites:

- Home Wi-Fi network
- Wi-Fi enabled Miele cooktop

- Connect the rangehood and cooktop to your home Wi-Fi network (see "Setting up Miele@home").

The Con@ctivity function will be activated automatically.

Con@ctivity via a direct Wi-Fi connection (Con@ctivity 3.0)

Prerequisite:

- Wi-Fi enabled Miele cooktop

If you do not have a home network, you can establish a direct connection between the cooktop and the rangehood.

- Manually switch the rangehood off.



- Press and hold the **B** control.

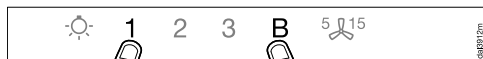

- Touch the **1** control for approx. 5 seconds at the same time.

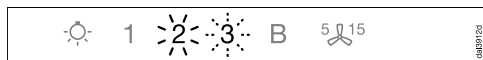

2 will light up constantly, **3** will flash on and off.

The rangehood will be ready for connection in the next 2 minutes.

- Start the Wi-Fi connection on the cooktop. For further details, see the cooktop operating instructions.

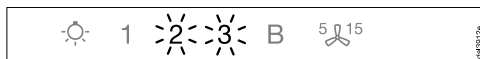

When successfully connected, **2** and **3** will light up constantly.



- Quit connection mode on the rangehood by touching the run-on control **5 15**.

Con@ctivity has now been activated.

With a direct Wi-Fi connection, it is not possible to connect the cooktop and the rangehood to a home network. Should this be required at a later date, the direct Wi-Fi connection between the cooktop and the rangehood must be disconnected first (see "Signing out of Wi-Fi").

Reattempting the connection

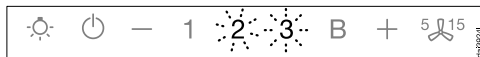

If it is not possible to connect, **2** and **3** flash or the rangehood cancels the process.

- Disconnect the connection to the rangehood (see "Signing out of Wi-Fi") and to the cooktop.
- Attempt to make the connection again.

When Con@ctivity is active, the rangehood always operates in automatic mode (see “Before using for the first time – Setting up Con@ctivity”).

If you wish to manually operate the rangehood, see “Operation (manual mode) – Cooking without Con@ctivity”.

Cooking with Con@ctivity (automatic mode)

- Switch on a cooking zone at any power level.

The cooktop lighting will come on.

After a few seconds the fan will switch on, first at power level **2**, then it will switch immediately to power level **1**.

The rangehood selects the power level automatically during cooking.

This is determined by the total output of the cooktop, i.e. the number of cooking zones in operation and the power levels selected.

If you select a higher power level on the cooktop or are using several cooking zones, the rangehood will switch to a higher power level.

When you reduce the power level on the cooktop or the number of cooking zones being used, the rangehood power level will also be reduced.

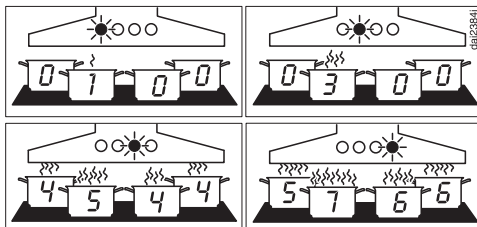

Examples for power levels **1** to **B**

Reaction time

The rangehood reacts with a slight delay because altering the power level on the cooktop does not immediately result in a reduction or increase in cooking vapours.

Because the cooktop transmits the information to the rangehood at intervals, this can also cause delays.

The reaction can vary from a few seconds to a few minutes.

Cooking process

- For example, you switch on a cooking zone at the highest power level to heat a pan for frying. After approx. 10 seconds to 4 minutes, you then reduce the power level (60 seconds to 5 minutes for a radiant cooktop).

The rangehood recognises a cooking process.

The rangehood switches itself on and when the cooktop power level has been reduced, the rangehood switches to power level 3 and remains at that level for approx. 5 minutes.

After that the rangehood power level is determined automatically by the Con@ctivity function.

You can select another power level manually before then.

Operation (automatic mode)

Switching off

- Switch off all cooking zones.

The rangehood fan will reduce its power level in stages over the next few minutes and will then switch itself off.

This helps to neutralise any lingering vapours and odours in the air.

- From the Booster setting, the fan switches immediately to level 3.
- From level 3, it will switch to level 2 after approx. 1 minute.
- From level 2, it will switch to level 1 after 2 minutes.
- After 2 minutes at Level 1, the fan switches itself off.
- After another 30 seconds, the cooktop lighting switches off.

The cooking process is then finished.

Leaving automatic mode temporarily

To leave automatic mode temporarily during cooking:

- Manually select a different power level, or
- Manually switch the rangehood off, or
- Activate the run-on function  on the rangehood. The fan will switch itself off after the selected run-on time, and the lighting will remain on.

The rangehood functions are now operated manually (see “Operation (manual mode)”).

Returning to automatic mode

The rangehood returns to automatic mode:

- if the rangehood has not been used for approx. 5 minutes after selecting a power level manually, or
- if the manually selected power level corresponds to the automatic one again, or
- if the rangehood fan and the cooktop have been switched off for at least 30 seconds.
Automatic mode will resume next time the cooktop is switched on.

You can also operate the rangehood manually for a complete cooking process.

- To do so switch the rangehood fan on **before** the cooktop.

If the rangehood fan and the cooktop have been switched off for at least 30 seconds after cooking, automatic mode will resume next time the cooktop is switched on.

Cooking without Con@ctivity (manual mode)

The rangehood can be operated manually if:

- the Con@ctivity function is not activated.
- You have temporarily deactivated the Con@ctivity function (see “Operation (manual operation) – Leaving automatic mode temporarily”).

Switching the fan on

Switch the fan on as soon as you start cooking. This is to ensure that vapours are captured right from the start.

- Touch the On/Off control .

The fan will come on at power level **2**.

Selecting a power level

For light to heavy cooking vapours and odours, select from power levels **1** to **3**. For short periods of cooking food with intensive vapours and a strong aroma, e.g. when searing meat, select Booster setting **B**.

- Select the power level required by touching a control from **1** to **B**.

Reducing power down from the Booster setting





If Power management is activated (default setting), the fan automatically switches back to level **3** after 5 minutes.

Selecting the run-on time

It is advisable to run the fan for a few minutes after cooking has finished. This helps to remove any lingering vapours and odours from the air.

It also reduces the risk of residues accumulating in the rangehood and any resultant odours.

The run-on function allows the fan to continue to run for a pre-determined time before switching itself off automatically.

- After you have finished cooking, touch the run-on control  with the fan still switched on:
 - Once: the fan will switch itself off after 5 minutes (**5**  lights up).
 - Twice: The fan will switch itself off after 15 minutes (**15**  lights up).
 - If you touch the run-on control  again, the fan will remain switched on ( will go out).

Switching the fan off

- Press the On/Off touch control  to switch the fan off.



Operation (manual mode)

Dimming/switching the cooktop lighting on/off

The cooktop lighting can be switched on and off and dimmed independently of the fan.

- Press the lighting sensor  briefly to switch it on or off.

The lighting will switch on at maximum brightness.

- To change the brightness, press and hold the lighting control  with the lighting switched on. The brightness will gradually dim until you release the control.
- To increase the brightness, press and hold the lighting  control again until the desired level has been reached and then release it.



Power management

The rangehood is fitted with a Power management system. The Power management system is designed to help save energy. It ensures that the fan power level is reduced automatically and that the lighting is switched off.

- If the Booster setting has been selected, the fan will automatically switch to setting 3 after 5 minutes.
- From fan power levels 3, 2 and 1, the power will be reduced by one level after 2 hours and then in 30-minute stages until the fan finally switches off.
- The cooktop lighting will switch off automatically after 12 hours.

You can deactivate Power management. Keep in mind that deactivating this function may increase energy consumption.

Activating/deactivating Power management

- Switch off the fan and the lighting.
- Touch the run-on control  for approx. 10 seconds until **1** lights up in the power levels display.
- Then touch in turn
 - the lighting control ,
 - the **1** control and then again
 - the lighting control .

When Power management is activated, the **1** and **B** indicators light up constantly.

When it is deactivated, the **1** and **B** indicators flash.

- To deactivate Power management, touch **1**.

The **1** and **B** indicators will flash.

- To activate Power management, touch **B**.

The **1** and **B** indicators will light up constantly.



- Confirm the setting by pressing the run-on control .

All the indicator lights will go out.

If you do not confirm your selection of setting within 4 minutes, the rangehood will revert to the previous setting.

Safety switch-off



If Power management has been deactivated, the rangehood will switch itself off automatically after 12 hours if it has been left on (fan and cooktop lighting).

- To switch it back on press the On/Off  control or the lighting control .

Operation (automatic and manual modes)

Operating hours counter



The rangehood registers the length of time it has been operated.

When the grease filter symbol  or the charcoal filter symbol  lights up, the operating hours counters are signalling that the filters need to be cleaned or replaced. Further information about cleaning and replacing the filters and resetting the operating hours counters can be found under "Cleaning and care".

Altering the grease filter operating hours counter

You can set the operating hours counter to suit the type of cooking you do.

The factory setting is a cleaning interval of 30 hours.

- Select a shorter time of 20 hours if you fry a lot.
- If you only cook occasionally, we recommend that you still select a short time for the counter. This is to prevent grease from hardening on the filter and making cleaning more difficult.
- Select a longer time of 40 or 50 hours if you use very little fat for cooking.
- Switch off the fan and the lighting.
- Touch the run-on control  and the grease filter control  at the same time.

The grease filter symbol  and one of the fan power level indicators will flash.

The fan power level indicators **1** to **B** show the time set:

1	20 hours
2	30 hours
3	40 hours
B	50 hours

- Touch the relevant control to select the duration required.
- Confirm your choice by touching the grease filter control .

All the indicator lights will go out.



If you do not confirm your selection within 4 minutes, the rangehood will automatically revert to the previous setting.

Operation (automatic and manual modes)

Altering the charcoal filter operating hours counter

You can set the operating hours counter to suit the type of cooking you do.

It is set at the factory for 180 hours of use before it needs to be replaced.

- Switch off the fan and the lighting.
- Touch the run-on control  and the charcoal filter control  at the same time.

The charcoal filter symbol  and one of the fan power settings will flash.

The fan power setting indicators **1** to **B** show the time set:

1	120 hours
2	180 hours
3	240 hours
B	Deactivated



- Touch the relevant control to select the duration required.
- Confirm the selection by pressing the charcoal filter touch control .

All the indicator lights will go out.

If you do not confirm your selection within 4 minutes, the rangehood will automatically revert to the previous setting.

Reading the filter operating hours counter

You can check the percentage of time set already used before the filters need replacing.

- Switch the fan on with the On/Off touch control .
- Press and hold the grease filter control  or the charcoal filter control .

One or more of the power level indicators will flash.

The number of flashing indicators shows the percentage of the operating time which has already been used up.

1	25 %
1 and 2	50 %
1 to 3	75 %
1 to B	100 %

The number of operating hours used remains in the memory even when the appliance is switched off or there is a power cut.

This rangehood operates very efficiently and economically. The following will help you to save even more energy when using it:

- Ensure there is sufficient ventilation in the kitchen when cooking.
 - Always cook with the lowest possible setting. This produces fewer cooking vapours, so you can use a lower rangehood power level and therefore benefit from reduced energy consumption.
 - Clean or change the filters at regular intervals. Heavily soiled filters reduce performance, increase the risk of fire and are unhygienic.
- Use the Con@ctivity function. The rangehood will switch on and off automatically. The rangehood will select the optimum power level for the cooking you are doing, which ensures low energy consumption.
 - If you are operating the rangehood manually, please note the following:
 - Check the power level selected on the rangehood. A low power level is usually sufficient. Only use the Booster setting when necessary.
 - When a large volume of cooking vapours are being produced, switch to a high power level in good time. This is more efficient than operating the rangehood for longer to try to capture cooking vapours which have already been distributed throughout the kitchen.
 - Make sure that you switch the rangehood off after use. If cooking vapours and odours still need to be removed from the kitchen air after cooking, use the run-on function. The fan will switch off automatically after the selected run-on time.

Cleaning and care

 Before carrying out any maintenance or cleaning, the rangehood must be disconnected from the electricity supply (see “Warning and Safety instructions”).

Housing

General

 The surfaces and controls are susceptible to scratches and abrasion.

Please observe the following cleaning instructions.

- All external surfaces and controls can be cleaned using warm water with a small amount of washing-up liquid applied with a well wrung-out soft sponge or cloth.
- After cleaning, wipe the surfaces dry using a soft cloth.

Do not use:

- cleaning agents containing soda, acids, chlorides or solvents,
- abrasive cleaning agents, e.g. powder cleaners or cream cleaners and abrasive sponges, as well as pot scourers or sponges which have been used previously with abrasive cleaning agents. These will damage the surface material.

Important information for appliances with stainless steel surfaces

Stainless steel surfaces can be cleaned with a non-abrasive cleaning agent designed specifically for use on stainless steel.

To prevent the surfaces from quickly becoming dirty again, we recommend treating them with a stainless steel care product (available from Miele).

Important for appliances with lacquered casing

Minor scratches on the surface are inevitable when cleaning the casing; they may be visible depending on the lighting in the kitchen.

Important for appliances with glass surfaces

- Glass surfaces can be cleaned using a proprietary non-abrasive cleaning agent designed specifically for use on glass.

Grease filters

 Fire hazard!

Oversaturated grease filters are a fire hazard.

Clean the grease filters at regular intervals.

The re-usable metal grease filters in the appliance remove solid particles (grease, dust, etc.) from the kitchen vapours, preventing soiling of the rangehood.

The grease filters must be cleaned at regular intervals.

Heavily soiled grease filters hinder air extraction and will lead to increased levels of soiling in the rangehood and in the kitchen.

Grease filter cleaning intervals

Accumulated grease solidifies over a longer period of time and makes cleaning more difficult. The grease filters should therefore be cleaned every 3 to 4 weeks.

The operating hours control reminds you to regularly clean the grease filters by illuminating the grease filter symbol .

You can set the operating hours counter interval to suit the type of cooking you do (see “Operation (automatic and manual modes)”).

Removing the grease filter

 When handling the grease filter, be careful not to drop it.

This can result in damage to the filter and the cooktop below.

Make sure you hold the filter securely at all times when handling it.

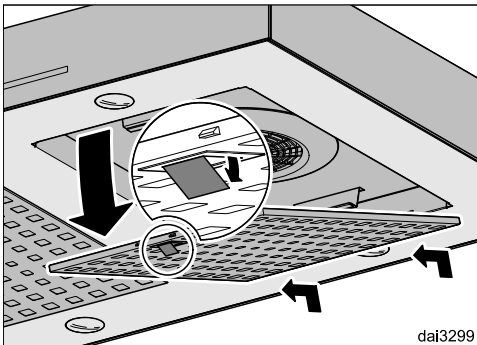

dai3299

- To take out the grease filter, release the locking clip on the filter, lower the filter approx. 45°, unhook it at the back and remove it.

Cleaning the grease filters by hand

- Clean the filters with a soft nylon brush in a mild solution of hot water and a small amount of washing-up liquid. Do not use undiluted washing up liquid.

Unsuitable cleaning agents

Unsuitable cleaning agents can cause damage to the surface of the filters if used regularly.

Do not use:

- cleaning agents containing descaling agents,
- powder cleaners or cream cleaners,
- aggressive all-purpose cleaning agents or spray cleaners for grease,
- oven sprays.

Cleaning and care

Cleaning the grease filters in the dishwasher

 Risk of damage due to excessively high temperatures in the dishwasher.

Excessively high temperatures may cause the grease filters to become unusable, if they become deformed, for example.

Select a programme that does not exceed the recommended temperature.

Also follow the information provided in the operating instructions for the dishwasher.

- Place the grease filters upright or slightly inclined in the lower basket. Ensure the spray arm is not obstructed.
- Use a standard household cleaning detergent.
- Select a programme with a maximum wash temperature of 65 °C.

Depending on the detergent used, the internal filter surfaces may become discoloured. This will not affect the functioning of the grease filters in any way.

After cleaning

- After cleaning, leave the filters to dry on an absorbent surface before refitting them.
- When removing the filters for cleaning, also clean off any residues of oil or fat from the now accessible housing to prevent the risk of these catching fire.
- Refit the grease filters. When inserting the grease filters, make sure that the latch faces outwards.

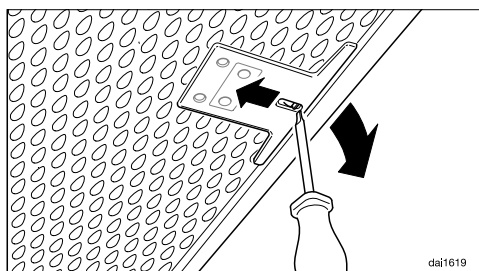

- If a grease filter is inadvertently fitted upside down, insert a small screwdriver blade into the slit to disengage the clip.

Resetting the grease filter operating hours counter

After cleaning, the operating hours counter needs to be reset.

- With the fan is switched on, press the grease filter control  for approx. 3 seconds, until only **1** is flashing.

The grease filter symbol  goes out.

If the grease filters are cleaned before the operating hours counter has reached its maximum:

- Touch the grease filter control  for approx. 6 seconds, until only **1** is flashing.

Change grease filters

Regular use and cleaning can cause the filter surfaces to wear.

If you notice any damage, replace the grease filters.

You can obtain grease filters from Miele customer service (see end of these operating instructions) or from your Miele specialist dealer.

NoSmell active charcoal filters

Four charcoal filters must be fitted in addition to the grease filters. These are designed to absorb cooking odours.

The charcoal filters are fitted in the canopy from above.

Fitting/replacing charcoal filters

- Take the charcoal filters out of their packaging.

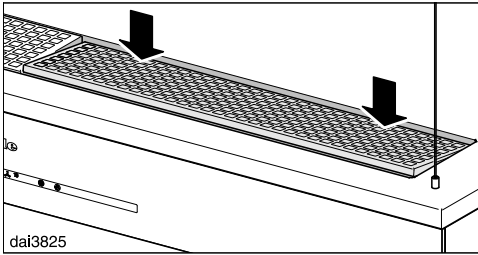

- Open the holders for the charcoal filters.

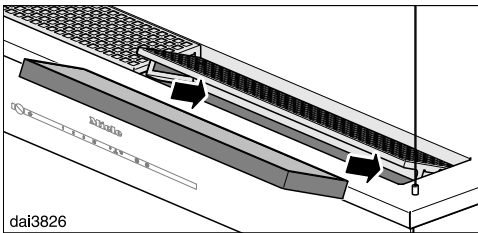

- Insert the charcoal filters and close the holders again.

When to change the NoSmell active charcoal filters

- Always replace the charcoal filters when they no longer absorb kitchen odours effectively. They should, however, be replaced at least every 2 years.

The operating hours counter will remind you to replace the charcoal filters by lighting up the charcoal filter symbol .

Resetting the charcoal filter operating hours counter

After changing the charcoal filters, the operating hours counter needs to be reset.

- Touch the charcoal filter control  for approx. 3 seconds with the rangehood switched on until only the indicator light for setting **1** is flashing.

The charcoal filter symbol  goes out.

If you want to replace the charcoal filters **before** the operating hours counter has reached its maximum:

- Touch the charcoal filter control  for approx. 6 seconds until only the indicator light for setting **1** is flashing.

Disposing of the charcoal filters

- Used charcoal filters can be disposed of with the normal household waste.

Reactivatable charcoal filters

Reactivatable charcoal filters are available for this rangehood. They can be used several times after being reactivated in the oven.

Please follow the operating instructions supplied with the filter.

Charcoal filters are available to order via the Miele online shop (see end of this booklet for contact details) or directly from Miele.

The charcoal filters are listed under “Technical data” at the back of this booklet.

Service

You can find information on how to remedy faults yourself and about Miele spare parts at www.miele.com.au/service or www.miele.co.nz/service.

Contact in case of fault

In the event of any faults which you cannot remedy yourself, please contact Miele.

You can book a Miele customer service call-out online at www.miele.com.au/service or www.miele.co.nz/service.

Contact information for Miele can be found at the end of this booklet.

Please quote the model and serial number of your appliance when contacting Miele. This information can be found on the data plate.

Position of the data plate

The data plate is visible after removing the grease filters.

Warranty

The manufacturer's warranty for this appliance is 2 years.

For further information, please refer to your warranty booklet.

Before installation

 Before installation, it is important to read the information given on the following pages as well as the “Warning and Safety instructions” at the beginning of this booklet.

Assembly parts

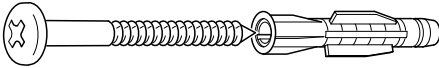

56612048x50

4 screws 5 x 60 mm and
4 plugs 8 x 50 mm

for securing the rangehood to the ceiling.

 The screws and plugs are suitable for use in concrete ceilings only.

For other types of ceiling construction, alternative fixings will be required.

Make sure the ceiling is able to take the weight of the rangehood.

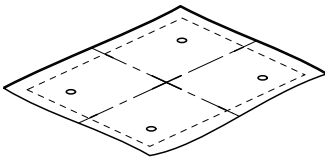

da12796

Drilling template

One of the cardboard inserts serves as drilling template.

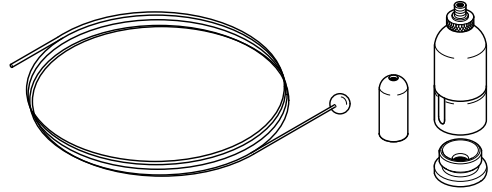

4 sets of ceiling fixings

For suspending the rangehood, comprising 4 suspension cables, 4 housing fixings and 4 ceiling fixings.

 The wire cables must not be used to secure additional components (e.g. an interim shelf).

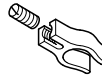

06277310

3 cable clamps

For securing the mains connection cable to one of the suspension cables.



da12791

1 cable guide

For securing the mains connection cable to one of the ceiling fixings.

Installation instructions

See enclosed installation sheet for instructions on how to install this appliance.

 Failure to install the screws or fixing device in accordance with these instructions may result in electrical hazards.

Installation

Appliance dimensions

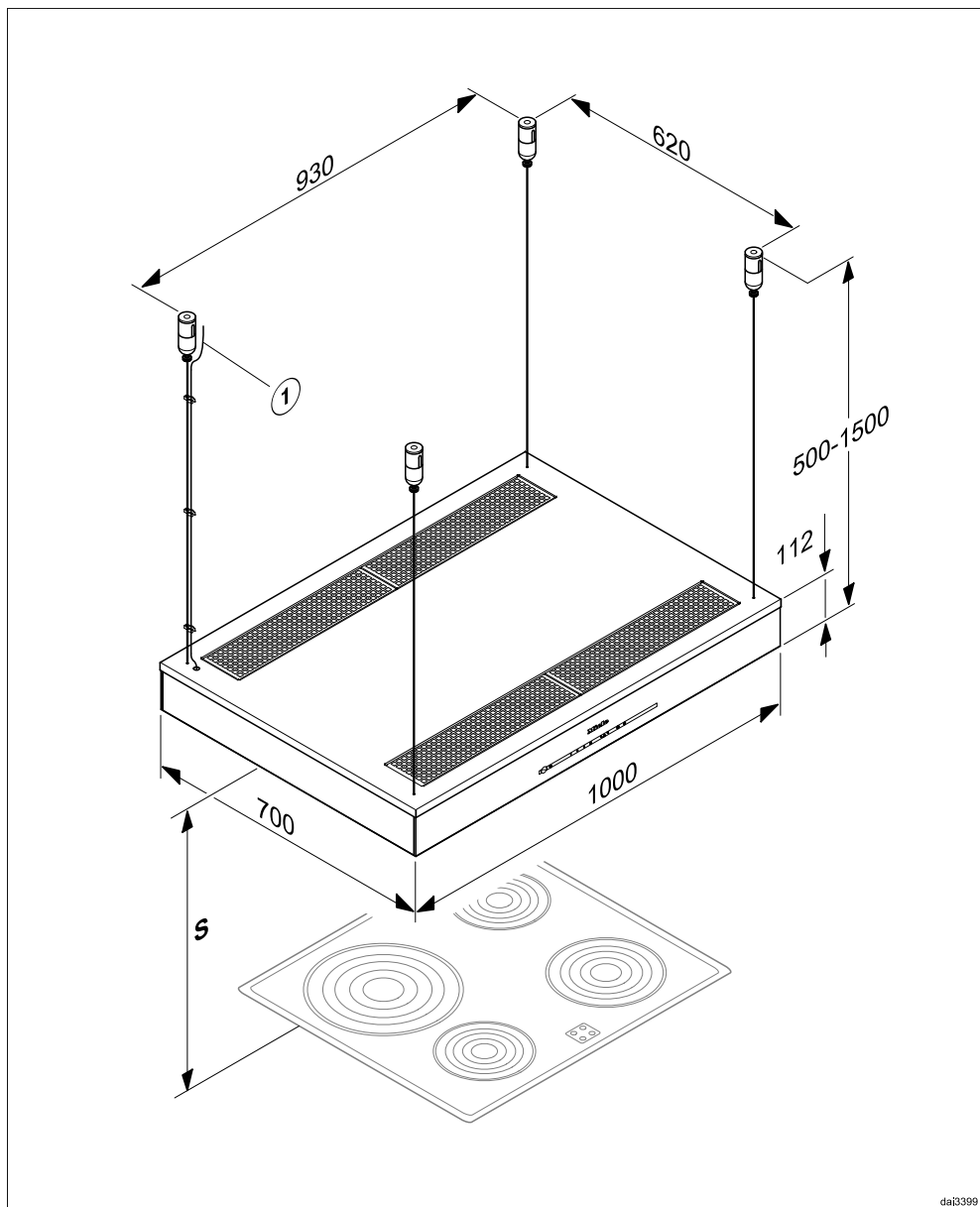

① Mains connection cable

Safety distance (S)

The minimum distances between the cooking surface of a cooktop (pan support(s) for gas models) and the bottom of the rangehood are as follows, unless a greater distance is specified by the manufacturer of your cooking appliance. See also “Warning and Safety instructions”.

Cooking appliance	Minimum distance S
Electric cooktop	600 mm (AU, NZ) 450 mm (HK, MY, SG, TH, TW)
Electric grill, deep fat fryer (electric)	650 mm
Multi-burner gas cooktop with maximum 45.4 MJ/h total output, with no burner having a greater output than 16.2 MJ/h.	650 mm
Multi-burner gas cooktop with total output greater than 45.4 MJ/h, but with a maximum of 77.8 MJ/h, with no burner having a greater output than 17.3 MJ/h.	760 mm
Multi-burner gas cooktop with total output greater than 77.8 MJ/h, with a single burner having a greater output than 17.3 MJ/h.	Not possible
Single burner gas cooktop with a maximum output of 21.6 MJ/h.	650 mm
Single burner gas cooktop with an output greater than 21.6 MJ/h, but with a maximum of 29.2 MJ/h.	760 mm
Single burner gas cooktop with an output greater than 29.2 MJ/h.	Not possible

Installation

Installation recommendations

- When deciding on the safety distance between the cooktop and rangehood, please note that a distance of 650 mm above electric cooktops may be preferable to give more working space under the rangehood.
- Account should also be taken of the height of the person who will be using the rangehood most often. They should have sufficient space to work comfortably at the cooktop, and be able to reach the rangehood controls with ease.
- If positioned too high, extraction will be inefficient.
- To achieve optimum vapour extraction, the rangehood must be centred over the cooktop, not to the side or behind it.
- The cooktop should be no wider than the rangehood and, if possible, it should be narrower, especially for safety distances greater than 750 mm.
- The installation area must be easily accessible. The rangehood should be easily accessible and easy to dismantle in the event that service is required. This should be taken into consideration when planning the position of cupboards, shelves, ceilings or features in the vicinity of the rangehood.

Electrical connection

 Installation, repairs and other work by unqualified persons could be dangerous. The manufacturer cannot be held liable for unauthorised work. All electrical work should be undertaken by a suitably qualified and competent person in strict accordance with current national and local safety and building code regulations. Ensure power is not supplied to the appliance until after installation or repair work has been carried out.

The wires in the mains lead are coloured in accordance with the following code:

Green/Yellow..... earth (⊕)
Blue neutral (N)
Brown.....live (L1)

The rangehood must be connected to a mains connection which complies with current local and national safety regulations.

For extra safety, it is advisable to install a residual current device (RCD), with a trip current of 30 mA. Contact a qualified electrician for advice.

Connection of this appliance should be made via a suitable isolator which complies with national and local safety regulations. When switched off, there must be an all-pole contact gap of 3 mm in the switch (including switch, fuses and relays).

The connection data is given on the data plate (See “After sales service and warranty”). Ensure that this data matches the household mains supply.

Technical data

Fan motor	2 x 72 W
Cooktop lighting	4 x 3 W
Total rated load	156 W
Voltage, frequency	AC 230 V, 50 Hz
Fuse rating	10 A
Mains connection cable length	1.8 m
Weight	33 kg

Wi-Fi module

Frequency band	2.400–2.4835 GHz
Maximum transmission power	< 100 mW

Optional accessory for recirculation mode

Charcoal filter set DKF 21-P or DKF 21-R (reactivatable). The sets contain four charcoal filters.

Miele Australia Pty. Ltd.

ACN 005 635 398

ABN 96 005 635 398

Miele Head Office Melbourne:

Level 4, 141 Camberwell Road

Hawthorn East, VIC 3123

1300 464 353 (1300 4 MIELE)**info@miele.com.au****www.miele.com.au****Hong Kong, China**

Miele (Hong Kong) Ltd.

41/F - 4101, Manhattan Place

23 Wang Tai Road, Kowloon Bay

Hong Kong

Tel.: (852) 2610 1025

Fax: (852) 3579 1404

E-mail: customerservices@miele.com.hk

Website: www.miele.hk

Singapore

Miele Pte. Ltd.

29 Media Circle

#11-04 ALICE@Mediapolis

Singapore 138565

Tel.: +65-67351191

Fax: +65-67351161

E-mail: info@miele.com.sg

Internet: www.miele.sg

Miele Global Headquarters Germany**Miele & Cie. KG** Carl-Miele-Straße 29, 33332 Gütersloh, Federal Republic of Germany**Miele New Zealand Ltd.**

IRD 98 463 631

Head Office:

8 College Hill

Freemans Bay, Auckland 1011

0800 464 353 (0800 4 MIELE)**customercare@miele.co.nz****www.miele.co.nz****Malaysia**

Miele Sdn Bhd

Suite 12-2, Level 12

Menara Sapura Kencana Petroleum

Solaris Dutamas No. 1, Jalan Dutamas 1

50480 Kuala Lumpur, Malaysia

Phone: +603-6209-0288

Fax: +603-6205-3768

Thailand

Miele Appliances Ltd.

BHIRAJ TOWER at EmQuartier

43rd Floor Unit 4301-4303

689 Sukhumvit Road

North Klongton Sub-District

Vadhana District

Bangkok 10110, Thailand

DA 6708 D

en-AU, NZ

M.-Nr. 11 418 220 / 03