

Operating and installation instructions Rangehood



To prevent the risk of accidents or damage to the appliance, it is **essential** to read these instructions before it is installed and used for the first time.

Contents

Warning and Safety instructions	4
Caring for the environment	11
Guide to the rangehood	12
Description of the functions	14
Before using for the first time	15
Selecting extraction mode or recirculation mode	15
Setting up Miele@home	15
Connecting via the App	16
Connecting via WPS	17
Signing out of Wi-Fi (reset to factory settings)	18
Setting up Con@ctivity	18
Con@ctivity via the home Wi-Fi network (Con@ctivity 3.0)	19
Con@ctivity via a direct Wi-Fi connection (Con@ctivity 3.0)	19
Reattempting the connection	19
Operation (automatic mode)	20
Cooking with Con@ctivity (automatic mode)	20
Cooking process	20
Leaving automatic mode temporarily	21
Returning to automatic mode	21
Operation (manual mode)	22
Cooking without Con@ctivity (manual mode)	22
Switching the fan on	22
Selecting a power level	22
Selecting the second Booster level	22
Selecting the run-on time	23
Switching the fan off	23
Dimming/Switching the cooktop lighting on/off	23
Safety switch-off	23
Changing settings	24
Altering the grease filter operating hours counter	24
Altering or deactivating the charcoal filter operating hours counter	24
Deactivating Power management	25
Buzzer for the sensors	25
Energy saving tips	26
Cleaning and care	27
Housing	27
Important information for appliances with stainless steel surfaces	27
Grease filters	27
Change grease filters	29

Contents

NoSmell active charcoal filters.....	29
Resetting the charcoal filter operating hours counter.....	29
Disposing of the charcoal filters.....	30
Reactivatable charcoal filters.....	30
Service.....	31
Contact in case of fault.....	31
Position of the data plate.....	31
Warranty.....	31
Installation.....	32
Before installation.....	32
Installation recommendations.....	32
Installation materials.....	32
Installation materials for recirculation mode.....	33
Appliance dimensions.....	34
Safety distance (S).....	36
Adjusting the vapour shield.....	37
Connection for air extraction.....	38
Non-return flap.....	38
Condensed water.....	39
Silencer.....	39
Electrical connection.....	40
Technical data.....	41
Optional accessory for recirculation mode.....	41

Warning and Safety instructions

This rangehood complies with all relevant local and national safety requirements. However, inappropriate use can lead to personal injury and damage to property.

Read the operating and installation instructions carefully before using the rangehood. They contain important information on the safety, installation, use and maintenance of the appliance. This prevents both personal injury and damage to the rangehood.

In accordance with standard IEC 60335-1, Miele expressly and strongly advises that you read and follow the instructions in “Installation” and in the “Warning and Safety instructions”.

Miele cannot be held liable for injury or damage caused by non-compliance with these instructions.

Keep these instructions in a safe place and pass them on to any future owner.

Correct application

► This rangehood is designed for domestic use and for use in similar environments by guests in hotel or motel rooms, bed & breakfasts and other typical living quarters. This does not include common/shared facilities or commercial facilities within hotels, motels or bed & breakfasts.

► The appliance is not suitable for outdoor use.

► It must only be used to extract vapours and remove odours from cooking.

Any other usage is at the owner's risk. Miele cannot be held liable for damage resulting from incorrect or improper use or operation.

► The rangehood cannot be used to ventilate the room in which it is installed in recirculation mode above a gas cooktop. Please seek the advice of a qualified gas fitter for more information if necessary.

► This appliance is not intended for use by persons (including children) with reduced physical, sensory or mental capabilities, or lack of experience and knowledge, unless they have been given supervision or instruction concerning its use by a person responsible for their safety, and are able to recognise the dangers of misuse.

Safety with children

- ▶ Young children must not be allowed to use the rangehood.
- ▶ Older children may only use the rangehood if its operation has been clearly explained to them and they are able to use it safely. They must be able to understand and recognise the possible dangers caused by incorrect operation.
- ▶ Cleaning work may only be carried out by older children under the supervision of an adult.
- ▶ Children should be supervised near the appliance. Ensure that they do not play with the appliance.
- ▶ The cooktop lighting is very intense. Ensure, in particular, that babies/small children do not look directly at the light.
- ▶ Danger of suffocation! Children may be able to wrap themselves in packing material or pull it over their heads with the risk of suffocation. Keep children away from any packing material.

Technical safety

- ▶ Unauthorised installation, maintenance and repairs (including removal of any cover) can cause considerable danger for the user. Installation must be performed by a suitably qualified and competent person. Maintenance and repairs must only be carried out by a Miele authorised technician.
- ▶ A damaged appliance can be dangerous. Check it for visible signs of damage. Do not use a damaged appliance.
- ▶ The electrical safety of this appliance can only be guaranteed when continuity is complete between it and an effective earthing system. It is most important that this basic safety requirement is present and tested regularly and, where there is any doubt, the household wiring system should be inspected by a qualified electrician.
- ▶ The connection data (voltage and frequency) on the data plate of the rangehood must match the mains electricity supply in order to avoid the risk of damage to the rangehood. Compare this before connecting the appliance to the mains electricity. If in doubt, consult a qualified electrician.

Warning and Safety instructions

▶ Temporary or permanent operation with a self-sufficient or non-mains synchronous energy supply system (e.g. isolated networks, back-up systems) is possible. A requirement for the operation is that the energy supply system complies with all current local and national requirements that apply to stand-alone, solar and/or battery systems. The protective measures provided in the installation and in this Miele product must also be assured in their function and operation in isolated operation or in non-mains synchronous operation, or replaced with equivalent measures in the installation.

▶ Do not connect the appliance to the mains electricity supply by a multi-socket unit or an extension lead. Extension leads are a fire hazard and do not guarantee the required safety of the appliance.

▶ For safety reasons, this appliance may only be used after it has been built in.

▶ This rangehood must not be installed and operated in mobile installations (e.g. on a ship).

▶ Tampering with electrical connections or components and mechanical parts is highly dangerous to the user and can cause operational faults.

Only open the housing as described in the instructions given in the installation sheet and in the “Cleaning and care” section of this booklet. Under no circumstances should any other parts of the housing be opened.

▶ During installation, maintenance and repair work, the appliance must be disconnected from the mains electricity supply. It is only completely isolated from the electricity supply when:

- the mains circuit breaker is switched off, or
- it is switched off at the wall socket and the plug is withdrawn from the socket. Do not pull the mains connection cable but the mains plug to disconnect your appliance from the mains electricity supply.

▶ The manufacturer's warranty will be invalidated if the appliance is not repaired by a Miele authorised service technician.

▶ If the mains connection cable is damaged, it must only be replaced by a Miele authorised service technician or suitably qualified and competent electrician in order to avoid a hazard.

▶ The lamps are a built-in component of the lighting. Replacement lamps may only be installed by a Miele authorised technician.

Warning and Safety instructions

Using at the same time as other heating appliances that depend on the air from the room

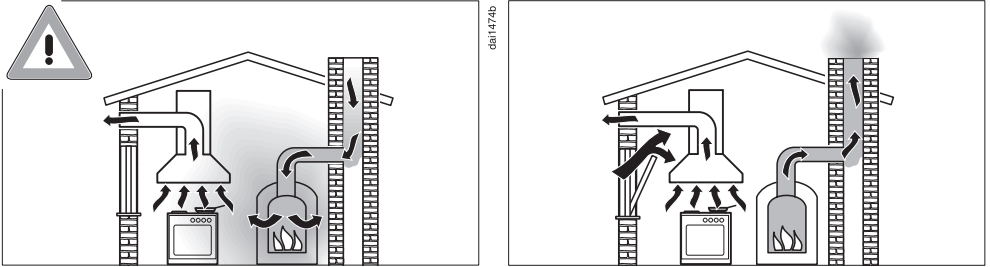

Danger of toxic fumes!

Great care should be taken when using the rangehood in the same room or the same area of the house as another heating appliance that depends on the air from the room.

Such heating appliances draw in air from the room and duct exhaust gases out through a chimney or extraction ducting. They include gas, oil, wood and coal-fired boilers and heaters, continuous flow or other water heaters, gas cooktops and ovens.

The rangehood draws in air from the kitchen and from neighbouring rooms. This applies to the following modes of operation:

- extraction mode
- recirculation mode with a recirculation box installed outside the room.

If there is insufficient air, an underpressure will occur. The heating appliance may be starved of oxygen. This impairs combustion. Harmful gases could be drawn from the chimney or extraction ducting back into the room.

This could have potentially fatal consequences. Risk of death!

Warning and Safety instructions

In order to ensure safe operation and to prevent gases given off by a heating appliance from being drawn back into the room, when the rangehood and the heater are both operated simultaneously, an underpressure in the room of 0.04 mbar (4 Pa) is the maximum permissible.

Sufficient ventilation can be maintained by air inlets which cannot be blocked, e.g. in windows, doors and outside wall vents. The diameter of the inlet openings must enable sufficient ventilation. A ventilation brick alone is not generally sufficient to ensure safe ventilation.

The overall ventilation condition of the dwelling must be taken into account. If in any doubt, the advice of a competent builder or, for gas, a qualified gas fitter (registered with an official gas safety body in accordance with national safety regulations) must be sought.

If the rangehood is being operated in recirculation mode, whereby the air is redirected into the room in which it is installed, the above restrictions do not apply.

Correct use

► Open flames are a fire hazard!

Never use an open flame under the rangehood. To avoid the danger of fire, do not flambé or grill over an open flame. When switched on, the rangehood could draw flames into the filter. Kitchen grease deposits could ignite.

► The rangehood can become damaged when exposed to excessive heat.

- When using the rangehood over a gas cooktop, ensure that any burners in use are always covered by a pan. Switch the cooking zone off when a pan is removed, even for a short time.
- Select a pan which is suitable for the size of the burner.
- Regulate the flame so that it does not burn up the sides of the pan.
- Avoid overheating the pan (e.g. when cooking with a wok).

► Always switch the rangehood on when a cooking zone is in use, otherwise condensation may collect in the rangehood, which could cause corrosion.

Warning and Safety instructions

▶ Overheated oil and fat can ignite, causing fire damage to the rangehood.

When cooking with oil or fat, chip pans and deep fat fryers etc., do not leave the pans unattended. Similarly, never leave an open grill unattended when grilling.

▶ Do not use the rangehood without the filters in place. This way you will avoid the risk of grease and dirt getting into the appliance and hindering its smooth operation.

▶ The rangehood can get very hot during cooking due to heat rising from the cooktop.

Do not touch the housing or the grease filters until the rangehood has cooled down.

Correct installation

▶ To determine whether a rangehood may be operated above your cooking appliance, please refer to the information provided by the appliance's manufacturer.

▶ Safety regulations prohibit the fitting of a rangehood over solid fuel stoves.

▶ An insufficient safety distance between the stovetop and the rangehood can result in damage to the rangehood.

The minimum safety distances between the top of the cooktop and the bottom of the rangehood given in the "Installation" section of these instructions must be observed, unless the cooktop manufacturer states that a greater safety distance is required.

If more than one cooking appliance is fitted beneath the rangehood, and they have different minimum safety distances to the rangehood, select the greater distance.

▶ The information provided in "Installation" must be observed when installing the rangehood.

▶ There may be a risk of injury due to protruding parts and sharp edges.

Wear gloves that offer protection against cuts during assembly.

▶ All ducting, pipework and fittings must be of non-flammable material and comply with all relevant national and local building regulations.

Warning and Safety instructions

- ▶ The appliance must not be connected to a chimney or vent flue which is in current use for exhausting fumes from appliances burning gas or other fuels. Neither should it be connected to ducting which ventilates rooms with fireplaces.
- ▶ If exhaust air is to be extracted into a chimney or ventilation duct no longer used for other purposes, seek professional advice.

Cleaning and care

- ▶ There is a risk of fire if cleaning is not carried out as described in these operating instructions.
- ▶ Do not use a steam cleaning appliance to clean this appliance. The steam could reach electrical components and cause a short circuit.

Accessories and spare parts

- ▶ Use only genuine original Miele spare parts. If spare parts or accessories from other manufacturers are used, the warranty will be invalidated, and Miele cannot accept liability.
- ▶ Faulty components must only be replaced by genuine Miele spare parts. The manufacturer can only guarantee the safety of the appliance when Miele replacement parts are used.
- ▶ Miele will guarantee to supply functional spare parts for a minimum of 10 years and up to 15 years following the discontinuation of your appliance.

Disposal of the packing material

The transport and protective packaging has been selected from materials which are environmentally friendly for disposal, and can normally be recycled.

Recycling the packaging reduces the use of raw materials in the manufacturing process and also reduces the amount of waste in landfill sites.

Ensure that any plastic wrappings, bags etc. are disposed of safely and kept out of the reach of babies and young children. Danger of suffocation.

Only for Australia: Note for installer: Expanded polystyrene (EPS) packaging included. Please retain and dispose of EPS packaging responsibly. For further information, please contact Miele.

Disposing of your old appliance

Electrical and electronic appliances often contain valuable materials. They also contain specific materials, compounds and components, which were essential for their correct function and safety. These could be hazardous to human health and to the environment if disposed of with your domestic waste or if handled incorrectly. Please do not, therefore, dispose of your old appliance with your household waste.



Please dispose of it at your local community waste collection / recycling centre for electrical and electronic appliances. You are also responsible for deleting any personal data that may be stored on the appliance prior to disposal. Please ensure that your old appliance poses no risk to children while being stored prior to disposal.

Guide to the rangehood

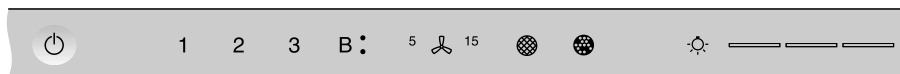
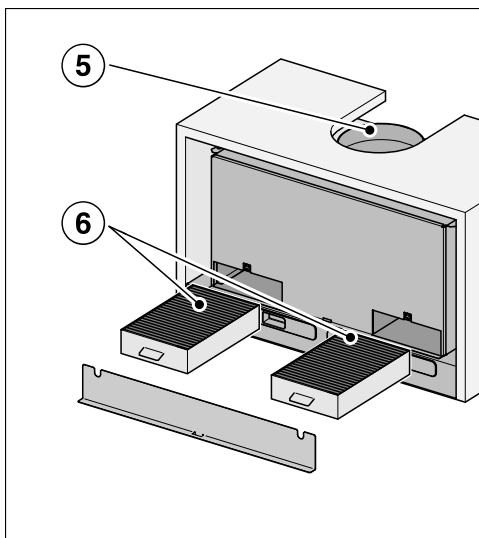
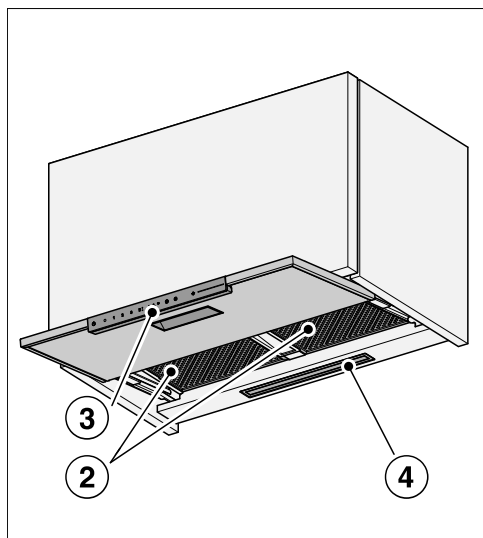
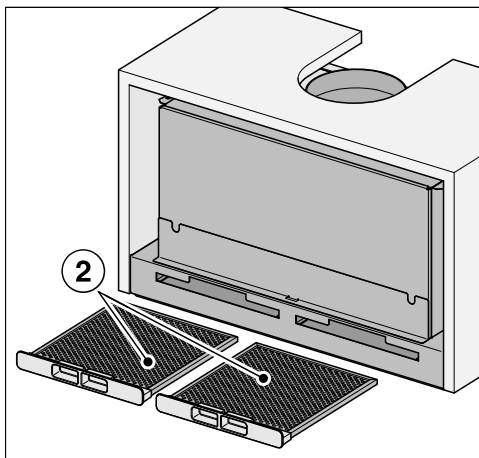
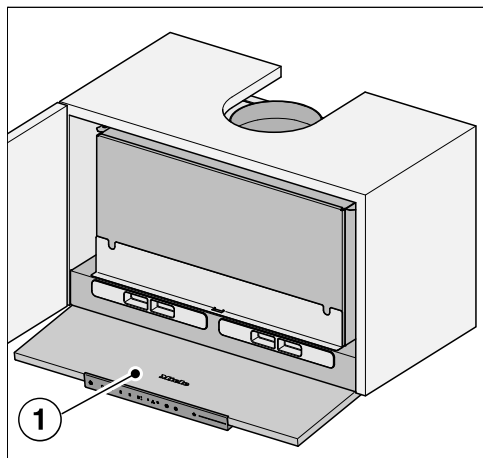

7

8

9

10

11

12

13

- ① Pull-out deflector plate
- ② Grease filter
- ③ Control panel
- ④ Cooktop lighting
- ⑤ Exhaust connection
- ⑥ Charcoal filter
 - Single-use or reactivatable charcoal filters
 - Optional accessory for recirculation mode
- ⑦ Sensor for switching the rangehood on and off
- ⑧ Sensors for switching the fan on and off and for setting the fan power level
- ⑨ Sensor for the run-on function
- ⑩ Sensor for the grease filter operating hours counter
- ⑪ Sensor for the charcoal filter operating hours counter
- ⑫ Sensor for switching the lighting on and off and for dimming the lighting
- ⑬ Sensors for selecting and displaying lighting levels

Description of the functions

Depending on the model of the rangehood, the following options are available:

Air extraction mode



The air is drawn in and cleaned by the grease filters and directed outside.

Recirculation mode

(available as an optional extra with a conversion kit and charcoal filter: see “Technical Data”)



The air is drawn in and cleaned first by the grease filters and then by a charcoal filter. The cleaned air is then recirculated back into the kitchen.





clh001941a

clh001941b

Selecting extraction mode or recirculation mode

The rangehood can be operated with either extraction mode or recirculation mode. The power of the fan is adapted to suit the selected mode of operation. The rangehood is set up at the factory for recirculation mode. It has to be reset for extraction mode.

To reset it for extraction mode, the operating hours counter for the charcoal filter(s) has to be deactivated.

- Pull out the deflector plate.
- Switch off the fan with the button **2** and the lighting with the button .
- Press and hold the run-on option control ⁵/₁₅ until the grease filter  and charcoal filter  symbols light up.
- Touch the charcoal filter symbol .

The charcoal filter symbol  and one of the fan power levels will flash.

- Touch the **B** control.
- Confirm your choice by touching the charcoal filter sensor .

All the indicator lights will go out.

Extraction mode has now been set.

If you do not confirm your selection within 4 minutes, the rangehood will automatically revert to the previous setting.

Setting up Miele@home

Prerequisites:

- a Wi-Fi network
- the Miele App
- a Miele user account. The user account can be created via the Miele App.

Your rangehood is equipped with an integrated Wi-Fi module. Connect the rangehood to your household Wi-Fi network. You will then be able to operate the rangehood via the Miele App.

If your Miele cooktop is connected to a home Wi-Fi network, you can control the rangehood automatically via the Con@ctivity function.

Before installing the rangehood in its final location, ensure that the signal of your Wi-Fi network is strong enough.

You can connect to the Wi-Fi network via the Miele@home App or via WPS.

Before using for the first time

Miele@home availability

The ability to use the Miele App depends on the availability of the Miele@home service in your country.

The Miele@home service is not available in every country.

For information about availability, please visit www.miele.com.

Miele App

You can download the Miele App from the Apple App Store® or the Google Play Store™ free of charge (only functional in selected countries).



Connecting via the App

The Miele App can be used to connect to your network.

- Install the Miele App on your mobile device.

To log in you will need:

1. Your Wi-Fi network password
2. Your rangehood password



The password for your rangehood consists of the last nine digits of the serial number, which can be found on the appliance's data plate.

The data plate is located on the casing of the rangehood and is visible when the cover for the charcoal filter slots is removed.







- Start the appliance registration in the App. Follow the login steps.

If requested to activate Wi-Fi on the rangehood, proceed as follows:

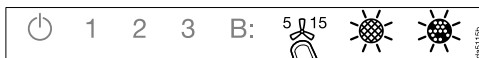
- Touch the On/Off sensor .

All symbols light up with reduced brightness.



- Press and hold the run-on option control  until the grease filter  and charcoal filter  symbols light up.



- Touch the **2** control.

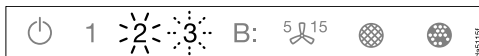

2 will light up constantly, **3** will flash on and off.

The rangehood is ready for connection during the next two minutes.



- Follow the instructions in the App.



When successfully connected **2** and **3** will light up constantly.

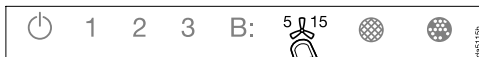

- Quit connection mode on the rangehood by touching the run-on control .

The rangehood can now be operated via the App.

Before using for the first time



Connecting via WPS

Your Wi-Fi router must support WPS (Wi-Fi Protected Setup).

- Touch the On/Off sensor .

All symbols light up with reduced brightness.



- Press and hold the run-on option control  until the grease filter  and charcoal filter  symbols light up.



- Touch the **2** control.

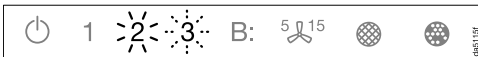

2 will light up constantly, **3** will flash on and off.

The Wi-Fi connection must be started on the rangehood at the same time as on the Wi-Fi router.



- Press the **B** control on the rangehood after a few seconds.

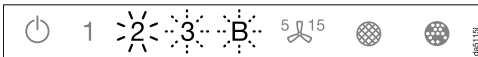

After a short while **2** will light up constantly, and **3** and **B** will flash on and off.

The rangehood is ready for connection during the next two minutes.



- Start the WPS connection on your Wi-Fi router.



When successfully connected **2** and **3** will light up constantly.



- Quit connection mode on the rangehood by touching the run-on control .

The rangehood can now be operated via the App.

If the connection fails, you have probably not connected WPS on your router quickly enough. Repeat the steps above.

Useful tip: If your Wi-Fi router does not support WPS, please connect via the Miele App.

Before using for the first time



Signing out of Wi-Fi (reset to factory settings)

To set up a new Wi-Fi connection, the existing Wi-Fi connection must first be disconnected.

■ Touch the On/Off sensor .

All symbols light up with reduced brightness.



■ Press and hold the run-on option control  until the grease filter  and charcoal filter  symbols light up.



■ Touch the **1** control.



With an existing Wi-Fi connection **2** and **3** will light up constantly.

The rangehood is ready for disconnection during the next two minutes.

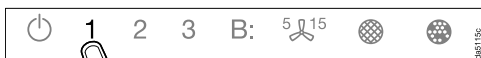

■ Touch the **1** control.



2 will light up constantly, **3** will flash on and off.



After a few seconds **2** and **3** will flash on and off. The connection has now been disconnected.

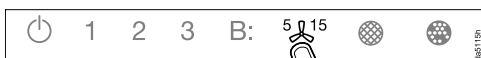

■ Quit disconnection mode on the rangehood by touching the run-on control .

The Wi-Fi connection has been disconnected. A new connection can now be set up.

Setting up Con@ctivity

Con@ctivity is the direct communication system between an electric Miele cooktop and a Miele rangehood. It enables the rangehood to operate automatically depending on the operational state of a Miele cooktop with onset controls.

- When the cooktop is switched on, the cooktop lighting on the rangehood comes on independently and, after a short time, the fan also switches on.
- The rangehood selects the power level automatically during cooking. The power level selected by the rangehood depends on the number of cooking zones being used and their power levels.
- After switching the cooktop off, the fan and the cooktop lighting will switch off automatically after a specified period of time.

See “Operation” for detailed information about this function.

Before using for the first time

Con@ctivity via the home Wi-Fi network (Con@ctivity 3.0)

Prerequisites:

- Home Wi-Fi network
- Wi-Fi enabled Miele cooktop

- Connect the rangehood and cooktop to your home Wi-Fi network (see "Setting up Miele@home").

The Con@ctivity function will be activated automatically.

Con@ctivity via a direct Wi-Fi connection (Con@ctivity 3.0)

Prerequisite:



- Wi-Fi enabled Miele cooktop

If you do not have a home network, you can establish a direct connection between the cooktop and the rangehood.

- Touch the On/Off sensor .

All symbols light up with reduced brightness.



- Press and hold the run-on option control  until the grease filter  and charcoal filter  symbols light up.

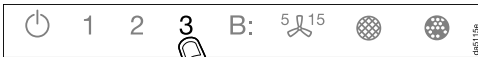

- Touch the **3** control.

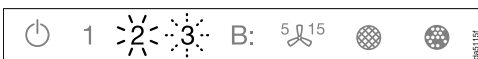

2 will light up constantly, **3** will flash on and off.

The rangehood is ready for connection during the next two minutes.

- Start the Wi-Fi connection on the cooktop. For further details, see the cooktop operating instructions.

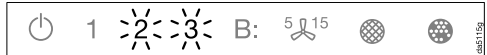

When successfully connected **2** and **3** will light up constantly.



- Quit connection mode on the rangehood by touching the run-on control .

Con@ctivity has now been activated.

With a direct Wi-Fi connection, it is not possible to connect the cooktop and the rangehood to a home network. Should this be required at a later date, the direct Wi-Fi connection between the cooktop and the rangehood must be disconnected first (see "Signing out of Wi-Fi").

Reattempting the connection

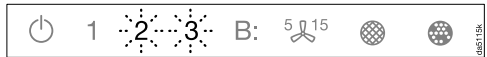

If it is not possible to connect, **2** and **3** flash or the rangehood cancels the process.

- Disconnect the connection to the rangehood (see "Signing out of Wi-Fi") and to the cooktop.
- Attempt to make the connection again.

Operation (automatic mode)

When Con@ctivity is active, the rangehood always operates in automatic mode (see “Before using for the first time – Setting up Con@ctivity”).

If you wish to manually operate the rangehood, see “Operation (manual mode) – Cooking without Con@ctivity”.

Cooking with Con@ctivity (automatic mode)

- Switch on a cooking zone at any power level.

The rangehood lighting will come on.

- Pull out the deflector plate.

The fan will come on at power level **2**.

The rangehood selects the power level automatically during cooking.

This is determined by the total output of the cooktop, i.e. the number of cooking zones in operation and the power levels selected.

- If you select a higher power level on the cooktop or are using several cooking zones, the rangehood will switch to a higher power level.
- When you reduce the power level on the cooktop or the number of cooking zones being used, the rangehood power level will also be reduced.

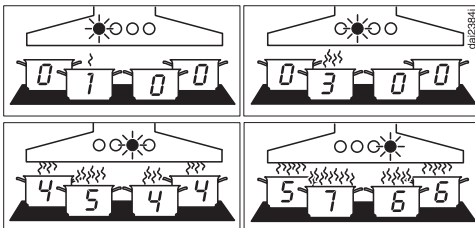

Examples for power levels **1** to **B**

Reaction time

The rangehood reacts with a slight delay because altering the power level on the cooktop does not immediately result in a reduction or increase in cooking vapours.

Because the cooktop transmits the information to the rangehood at intervals, this can also cause delays.

The reaction can vary from a few seconds to a few minutes.

Cooking process

- For example, you switch on a cooking zone at the highest power level to heat a pan for frying. After approx. 10 seconds to 4 minutes, you then reduce the power level (60 seconds to 5 minutes for a radiant cooktop).

The rangehood recognises a cooking process.

The rangehood switches itself on and when the cooktop power level has been reduced, the rangehood switches to power level 3 and remains at that level for approx. 5 minutes.

After that the rangehood power level is determined automatically by the Con@ctivity function.

You can select another power level manually before then.

Switching off

- Switch off all cooking zones.

The rangehood fan will reduce its power level in stages over the next few minutes and will then switch itself off.

This helps to neutralise any lingering vapours and odours in the air.

- From the Booster setting, the fan switches immediately to level 3.
- From level 3, it will switch to level 2 after approx. 1 minute.
- From level 2, it will switch to level 1 after 2 minutes.
- After 2 minutes at Level 1, the fan switches itself off.
- After another 30 seconds, the cooktop lighting switches off.

The cooking process is then finished.

If the deflector plate remains pulled out, the rangehood will be switched on automatically the next time the cooktop is switched on:

The fan switches on a few seconds after the cooktop switches on, initially at level 2, before immediately changing to level 1. Operation then continues automatically.

Leaving automatic mode temporarily

To leave automatic mode temporarily during cooking:

- Manually select a different power level, or
- Manually switch the rangehood off, or
- Activate the run-on function  on the rangehood. The fan will switch itself off after the selected run-on time, and the lighting will remain on.

The rangehood functions are now operated manually (see “Operation (manual mode)”).

Returning to automatic mode

The rangehood returns to automatic mode:

- if the rangehood has not been used for approx. 5 minutes after selecting a power level manually, or
- if the manually selected power level corresponds to the automatic one again, or
- the rangehood fan and the cooktop have been switched off for at least 30 seconds.
Automatic mode will resume next time the cooktop is switched on.

You can also operate the rangehood manually for a complete cooking process.

- To do so switch the rangehood fan on **before** the cooktop.

If the rangehood fan and the cooktop have been switched off for at least 30 seconds after cooking, automatic mode will resume next time the cooktop is switched on.

Operation (manual mode)

Cooking without Con@ctivity (manual mode)

The rangehood can be operated manually if:

- the Con@ctivity function is not activated.
- You have temporarily deactivated the Con@ctivity function (see “Operation (manual operation) – Leaving automatic mode temporarily”).

Switching the fan on

Switch the fan on as soon as you start cooking. This is to ensure that vapours are captured right from the start.

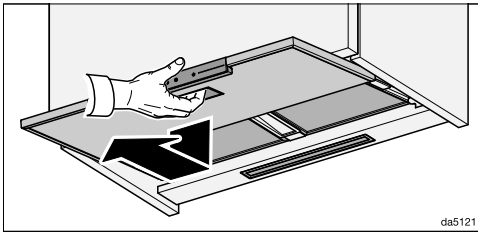

- Pull out the deflector plate. To ensure optimum extraction and a low noise level, pull the canopy all the way out.

The fan will switch on at power level **2**.

Selecting a power level

For light to heavy cooking vapours and odours, select from power levels **1** to **3**.

For short periods of cooking food with intensive vapours and a strong aroma, e.g. when searing meat, select Booster setting **B**.

- Select the power level required by touching a control from **1** to **B**.

Selecting the second Booster level

- When you select the Booster level, the **B**• symbol lights up. To increase the power level further, touch **B** again.

The **B**• symbol lights up.

The second Booster level is activated. The air throughput is increased for a short time.

Switching back the Booster levels

If Power management is activated (default setting), the first Booster level **B**• automatically switches back to level **3** after 5 minutes.





The second Booster level **B**• switches back after 2 minutes (even if Power management is deactivated).

Selecting the run-on time

It is advisable to run the fan for a few minutes after cooking has finished. This helps to remove any lingering vapours and odours from the air.

It also reduces the risk of residues accumulating in the rangehood and any resultant odours.

The run-on function allows the fan to continue to run for a pre-determined time before switching itself off automatically.

- After you have finished cooking, touch the run-on control  with the fan still switched on:
 - Once: the fan will switch itself off after 5 minutes ( lights up).
 - Twice: The fan will switch itself off after 15 minutes ( lights up).
 - If you touch the run-on control  again, the fan will remain switched on ( will go out).



Switching the fan off

- Touching the control for the active power level again switches the fan off.
- Also, when you slide in the vapor screen, the blower turns off.

Dimming/Switching the cooktop lighting on/off

- You can switch the cooktop lighting on by pulling the deflector plate out and off by pushing it in.
- When the deflector plate is pulled out, you can switch the cooktop lighting on and off with the lighting control .

The lighting will switch on at maximum brightness. All 3 bars next to the lighting control  light up.

- To change the brightness, press and hold the lighting control  with the lighting switched on. The brightness will gradually dim until you release the control.
- To increase the brightness, press and hold the lighting control  again until the desired level has been reached and then release it.
- Alternatively, you can select 3 brightness levels by touching the bars next to the lighting control .

Safety switch-off

If Power management has been deactivated, the fan and the cooktop lighting will switch off automatically after 12 hours if they have been left on.

- To switch back on, press the On/Off control .

Changing settings

All settings are made with the rangehood switched off.

- Pull out the deflector plate and switch off the fan and the lighting.

Altering the grease filter operating hours counter



You can set the operating hours counter to suit the type of cooking you do.

The factory setting is a cleaning interval of 30 hours.

- Select a shorter time of 20 hours if you fry a lot.
- If you only cook occasionally, we recommend that you still select a short time for the counter. This is to prevent grease from hardening on the filter and making cleaning more difficult.
- Select a longer time of 40 or 50 hours if you use very little fat for cooking.

- Touch the On/Off sensor .

All symbols light up with reduced brightness.

- Press and hold the run-on option control  until the grease filter  and charcoal filter  symbols light up.

- Touch the grease filter symbol .

The grease filter symbol  and one of the fan power level indicators will flash.

The fan power level indicators **1** to **B** show the time set:

- 1**..... 20 hours
- 2**..... 30 hours
- 3**..... 40 hours
- B**..... 50 hours

- Touch the relevant control to select the duration required.

- Confirm your choice by touching the grease filter control . If you do not confirm your selection within 4 minutes, the rangehood will automatically revert to the previous setting.

Altering or deactivating the charcoal filter operating hours counter

Charcoal filters are needed for recirculation mode.



You can set the operating hours counter to suit the type of cooking you do.

It has to be deactivated for extraction mode.

It is set at the factory for 180 hours of use before the filters need replacing.

- Touch the On/Off sensor .

All symbols light up with reduced brightness.

- Press and hold the run-on option control  until the grease filter  and charcoal filter  symbols light up.

- Touch the charcoal filter symbol .

The charcoal filter symbol  and one of the fan power levels will flash.

The fan power level indicators **1** to **B** show the time set:

- 1**..... 120 hours
- 2**..... 180 hours
- 3**..... 240 hours
- B**..... deactivated

- Touch the relevant control to select the duration required.

- Confirm your choice by touching the charcoal filter sensor . If you do not confirm your selection within 4 minutes, the rangehood will automatically revert to the previous setting.

Deactivating Power management



Keep in mind that deactivating this function may increase energy consumption.

Activating/deactivating Power management



- Touch the On/Off sensor .

All symbols light up with reduced brightness.

- Press and hold the run-on option control .

After a few seconds, the grease filter  and charcoal filter  symbols light up, and after a further 5 seconds the **1** fan power level indicator lights up.

The deflector plate extends.

- Then touch in turn
 - the lighting control ,
 - the **1** control and then again
 - the lighting control .

When Power management is activated, the **1** and **B** indicators light up constantly.

When it is deactivated, the **1** and **B** indicators flash.

- To deactivate Power management, touch **1**.

The **1** and **B** indicators will flash.

- To activate, touch **B**.

The **1** and **B** indicators will light up constantly.

- Confirm the setting by pressing the run-on control .

All the indicator lights will go out.

If you do not confirm your selection of setting within 4 minutes, the rangehood will revert to the previous setting.



Buzzer for the sensors

When a function is selected with the sensors, a short buzzer will sound for confirmation.

The buzzer can be switched off.

- Touch the On/Off sensor .

All symbols light up with reduced brightness.

- Press and hold the run-on option control  until the grease filter  and charcoal filter  symbols light up.

- Touch the **B** control.

The buzzer is switched off.

- If you want to switch the buzzer on again, proceed in the same way.

Regardless of the previous setting, the buzzer will be reactivated when power is restored to the rangehood after it has been disconnected from the mains electricity supply or after a power cut.

Energy saving tips

This rangehood operates very efficiently and economically. The following will help you to save even more energy when using it:

- Ensure that there is sufficient ventilation in the kitchen when cooking. In extraction mode, if there is insufficient air flow the rangehood cannot operate efficiently and this causes increased operating noise levels.
- Always cook with the lowest possible setting. This produces fewer cooking vapours, so you can use a lower rangehood power level and therefore benefit from reduced energy consumption.
- Clean or change the filters at regular intervals. Heavily soiled filters reduce performance, increase the risk of fire and are unhygienic.
- Use the Con@ctivity function. The rangehood will switch on and off automatically. The rangehood will select the optimum power level for the cooking you are doing, which ensures low energy consumption.
- If you are operating the rangehood manually, please note the following:
 - Check the power level selected on the rangehood. A low power level is usually sufficient. Only use the Booster setting when necessary.
 - When a large volume of cooking vapours are being produced, switch to a high power level in good time. This is more efficient than operating the rangehood for longer to try to capture cooking vapours which have already been distributed throughout the kitchen.
 - Make sure that you switch the rangehood off after use. If cooking vapours and odours still need to be removed from the kitchen air after cooking, use the run-on function. The fan will switch off automatically after the selected run-on time.

 Before carrying out any maintenance or cleaning, the rangehood must be disconnected from the electricity supply (see “Warning and Safety instructions”).

Housing

General

 The surfaces and controls are susceptible to scratches and abrasion. Please observe the following cleaning instructions.

- All external surfaces and controls can be cleaned using warm water with a small amount of washing-up liquid applied with a well wrung-out soft sponge or cloth.
- After cleaning, wipe the surfaces dry using a soft cloth.

Do not use:

- cleaning agents containing soda, acids, chlorides or solvents,
- abrasive cleaning agents, e.g. powder cleaners or cream cleaners and abrasive sponges, as well as pot scourers or sponges which have been used previously with abrasive cleaning agents. These will damage the surface material.

Important information for appliances with stainless steel surfaces

Stainless steel surfaces can be cleaned with a non-abrasive cleaning agent designed specifically for use on stainless steel.

To prevent the surfaces from quickly becoming dirty again, we recommend treating them with a stainless steel care product (available from Miele).

Important for appliances with glass surfaces

- Glass surfaces can be cleaned using a proprietary non-abrasive cleaning agent designed specifically for use on glass.

Grease filters

 Fire hazard!
Oversaturated grease filters are a fire hazard.
Clean the grease filters at regular intervals.

The re-usable metal grease filters in the appliance remove solid particles (grease, dust, etc.) from the kitchen vapours, preventing soiling of the rangehood.

The grease filters must be cleaned at regular intervals.

Heavily soiled grease filters hinder air extraction and will lead to increased levels of soiling in the rangehood and in the kitchen.

Grease filter cleaning intervals

Accumulated grease solidifies over a longer period of time and makes cleaning more difficult. The grease filters should therefore be cleaned every 3 to 4 weeks.

The operating hours control reminds you to regularly clean the grease filters by illuminating the grease filter symbol .

Cleaning and care

Removing the grease filter

⚠ When handling the grease filter, be careful not to drop it. This can result in damage to the filter and the cooktop below. Make sure you hold the filter securely at all times when handling it.

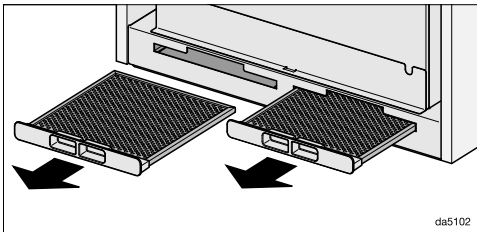

- Remove the grease filters from the slots on the front of the housing.

Cleaning the grease filters by hand

- Clean the filters with a soft nylon brush in a mild solution of hot water and a small amount of washing-up liquid. Do not use undiluted washing up liquid.

Unsuitable cleaning agents

Unsuitable cleaning agents can cause damage to the surface of the filters if used regularly.

Do not use:

- cleaning agents containing descaling agents,
- powder cleaners or cream cleaners,
- aggressive all-purpose cleaning agents or spray cleaners for grease,
- oven sprays.

Cleaning the grease filters in the dishwasher

⚠ Risk of damage due to excessively high temperatures in the dishwasher.

Excessively high temperatures may cause the grease filters to become unusable, if they become deformed, for example.

Select a programme that does not exceed the recommended temperature.

Also follow the information provided in the operating instructions for the dishwasher.

- Place the grease filters upright or slightly inclined in the lower basket. Ensure the spray arm is not obstructed.
- Use a standard household cleaning detergent.
- Select a programme with a maximum wash temperature of 65 °C.

Depending on the detergent used, the internal filter surfaces may become discoloured. This will not affect the functioning of the grease filters in any way.

After cleaning

- After cleaning, leave the filters to dry on an absorbent surface before refitting them.
- When removing the filters for cleaning, also clean off any residues of oil or fat from the now accessible housing to prevent the risk of these catching fire.
- Refit the grease filters.

Resetting the grease filter operating hours counter

After cleaning, the operating hours counter needs to be reset.

- While the fan is switched on, press the grease filter control  for approx. 3 seconds until only **1** is flashing.

The grease filter symbol  goes out.

Change grease filters

Regular use and cleaning can cause the filter surfaces to wear.

If you notice any damage, replace the grease filters.

You can obtain grease filters from Miele customer service (see end of these operating instructions) or from your Miele specialist dealer.

NoSmell active charcoal filters

With recirculation mode, two charcoal filters must be fitted in addition to the grease filters. These are designed to absorb cooking odours.

Charcoal filters are available to order via the Miele online shop (see the end of this booklet for contact details) or directly from Miele.

The part number of the charcoal filter required is listed under “Technical data”.

Fitting/Replacing the charcoal filters

The slots for the charcoal filters are located above the grease filters.

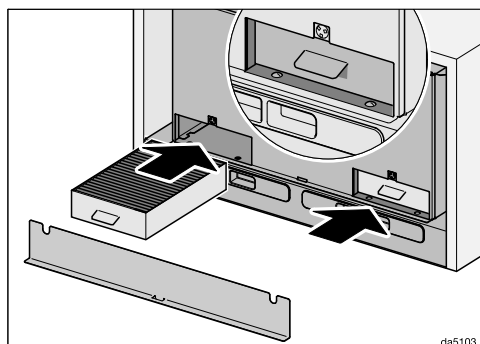

- Take the lid off. It is held in place by magnets.
- Take the charcoal filters out of their packaging.
- Insert the charcoal filters in the slots as far as they will go.
- Refit the lid.

When to change the NoSmell active charcoal filters

Replace the charcoal filters when they no longer absorb kitchen odours effectively, or at least every 6 months.

The operating hours counter will remind you to replace the charcoal filters by lighting up the charcoal filter symbol .

Resetting the charcoal filter operating hours counter

After changing the charcoal filters, the operating hours counter needs to be reset.

- Touch the charcoal filter control  for approx. 3 seconds with the rangehood switched on until only the indicator light for level **1** is flashing.

The charcoal filter symbol  goes out.

Cleaning and care

Disposing of the charcoal filters

- Used charcoal filters can be disposed of with the normal household waste.

Reactivatable charcoal filters

Reactivatable charcoal filters are available for this rangehood. They can be used several times after being reactivated in the oven.

Please follow the operating instructions supplied with the filter.

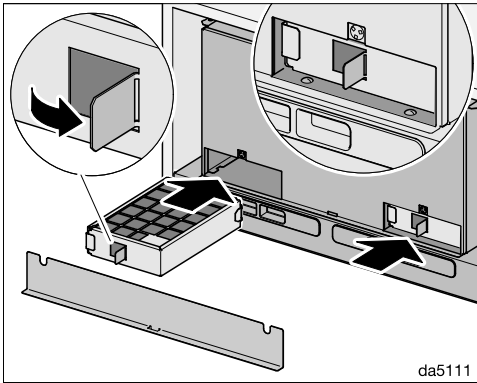

- Bend out the tab, e.g. with a screwdriver. The charcoal filter can be pulled out at the tab for removal.
- Insert the charcoal filters in the slots as far as they will go.
- Refit the lid.

You can find information on how to remedy faults yourself and about Miele spare parts at www.miele.com.au/service or www.miele.co.nz/service.

Contact in case of fault

In the event of any faults which you cannot remedy yourself, please contact Miele.

You can book a Miele customer service call-out online at www.miele.com.au/service or www.miele.co.nz/service.

Contact information for Miele can be found at the end of this booklet.

Please quote the model and serial number of your appliance when contacting Miele. This information can be found on the data plate.

Position of the data plate

The data plate is located on the casing of the rangehood and is visible when the cover for the charcoal filter slots is removed.

Warranty

The manufacturer's warranty for this appliance is 2 years.

For further information, please refer to your warranty booklet.

Installation

Before installation

 Before installation, it is important to read the information given on the following pages as well as the “Warning and Safety instructions” at the beginning of this booklet.

Installation recommendations

- To achieve optimum vapour extraction, the rangehood must be positioned centrally over the cooktop, not to the side.
- The cooktop should be no wider than the rangehood and, if possible, it should be narrower, especially for safety distances greater than 750 mm.
- The installation area must be easily accessible. The rangehood should be easily accessible and easy to dismantle in the event that service is required. This should be taken into consideration when planning the position of cupboards, shelves, ceilings or features in the vicinity of the rangehood.

Installation materials

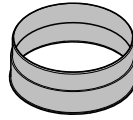

1 exhaust connection
for exhaust ducting \varnothing 150 mm.

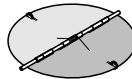

1 non-return flap
for fitting into the exhaust connection on the motor unit (not needed for recirculation mode).

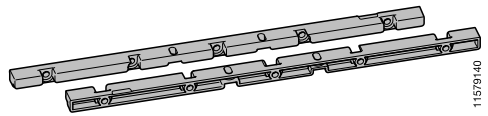

2 mounting brackets
for mounting in the cabinet

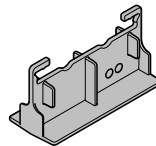

1 drilling template

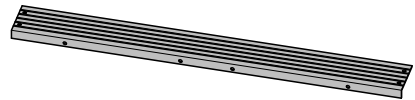

1 spacer strip
for concealing the gap between the rear of the appliance and the wall

08565780

08272520

11579140

11858020

115697850



01056271

6 screws, 4 x 15 mm



07602740

4 screws, M4 x 16 mm

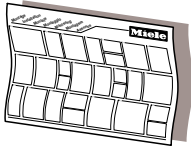

dina3mle

Installation plan

See the installation plan for details on the individual steps involved in the installation of this appliance.

Installation materials for recirculation mode

You need the following optional accessories for recirculation mode.

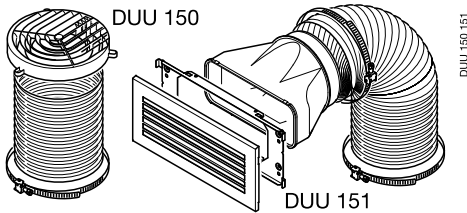

DUU 15x installation kit

contains a directional unit socket, hose and hose clips (DUU 150 for the top of the cabinet or DUU 151 for the sides or front of the cabinet)

Installation

Appliance dimensions

Diagram 1: DAS 8630 in a 600 mm wide cabinet.

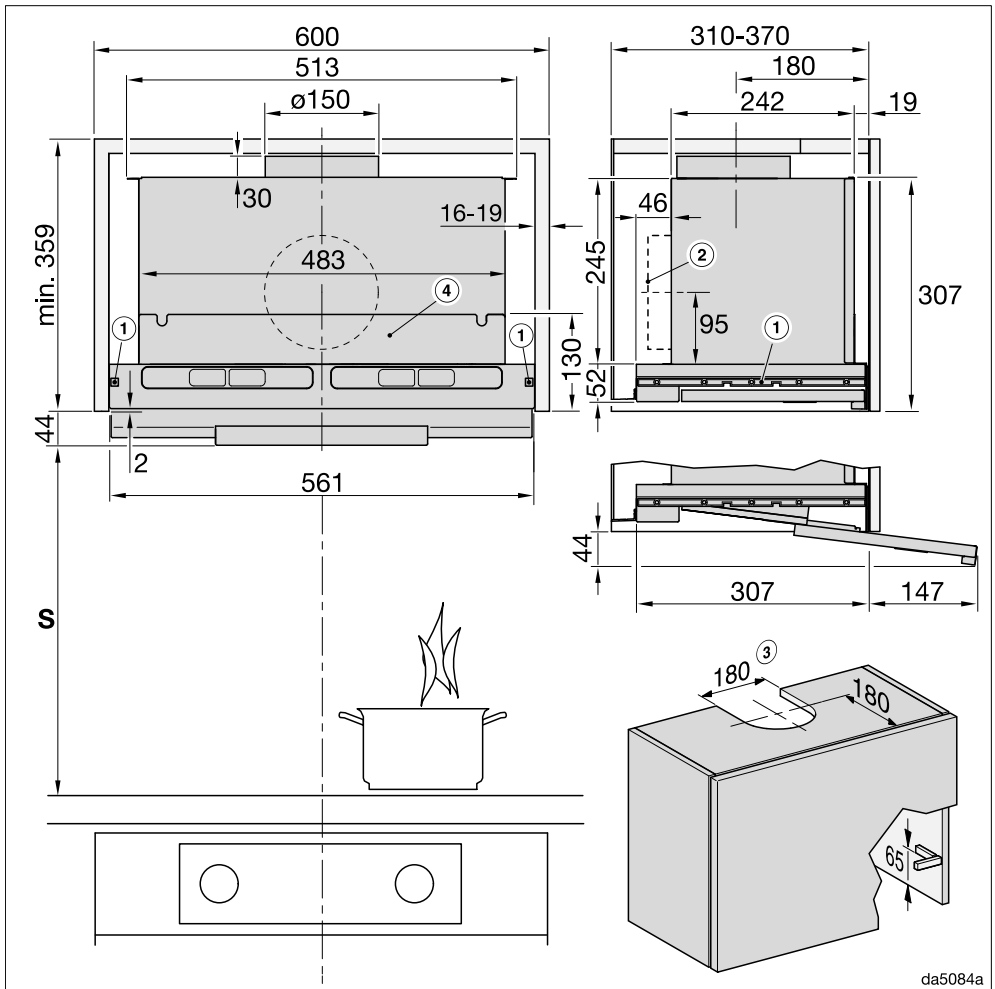

da5084a

The drawing is not to scale

Diagram 2: DAS 8930 in a 900 mm wide cabinet.

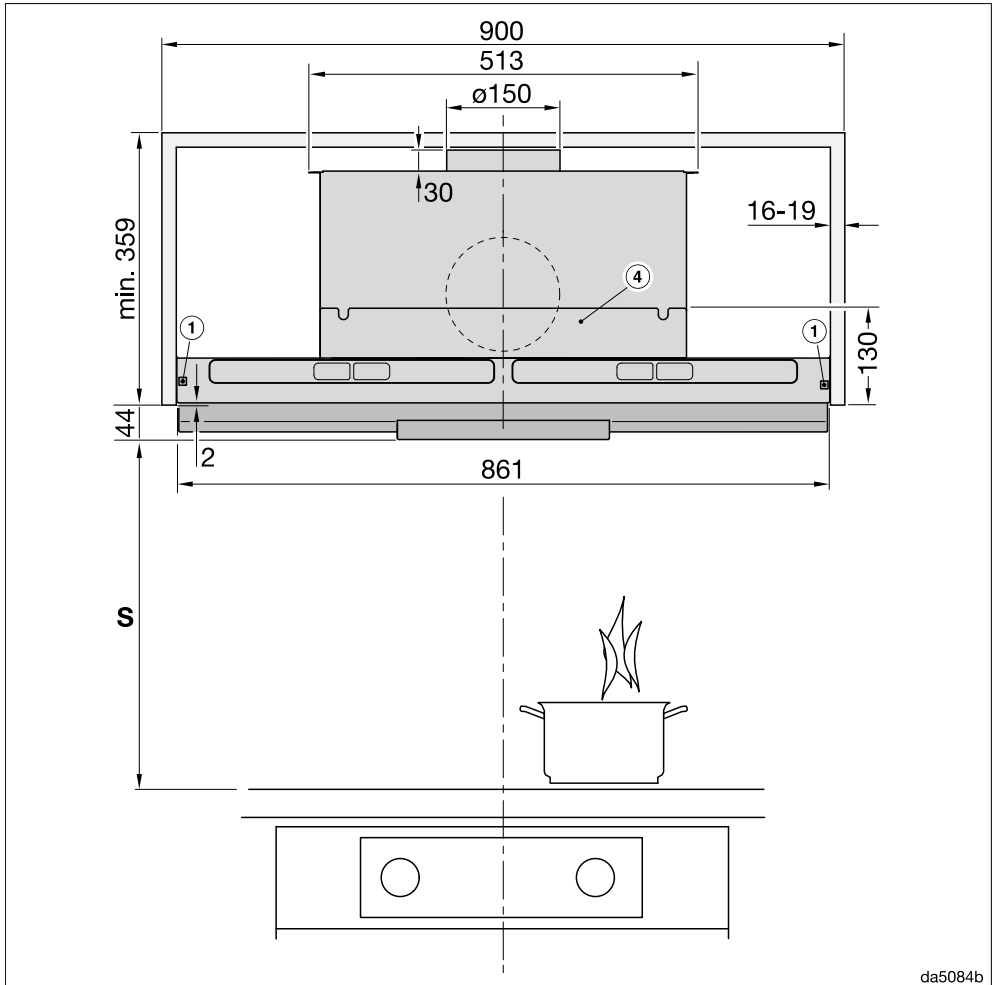

The drawing is not to scale

See diagram 1 for side view

Footnotes for diagrams 1 to 2:

- ① The mounting brackets are suitable for cabinets with wall thicknesses from 16 to 19 mm.
- ② The ducting can also be connected at the back.
- ③ Cut-out for extraction mode or for recirculation mode with conversion kit DUU 150
- ④ The wall unit can be fitted with a partition after installation. Slots for the grease filters, and with recirculation mode for the charcoal filters, must remain accessible.

Installation

Safety distance (S)

The minimum distances between the cooking surface of a cooktop (pan support(s) for gas models) and the bottom of the rangehood are as follows, unless a greater distance is specified by the manufacturer of your cooking appliance. See also “Warning and Safety instructions”.

Cooking appliance	Minimum distance S
Electric cooktop	600 mm (AU, NZ) 450 mm (HK, MY, SG, TH, TW)
Electric grill, deep fat fryer (electric)	650 mm
Multi-burner gas cooktop with maximum 45.4 MJ/h total output, with no burner having a greater output than 16.2 MJ/h.	650 mm
Multi-burner gas cooktop with total output greater than 45.4 MJ/h, but with a maximum of 77.8 MJ/h, with no burner having a greater output than 17.3 MJ/h.	760 mm
Multi-burner gas cooktop with total output greater than 77.8 MJ/h, with a single burner having a greater output than 17.3 MJ/h.	Not possible
Single burner gas cooktop with a maximum output of 21.6 MJ/h.	650 mm
Single burner gas cooktop with an output greater than 21.6 MJ/h, but with a maximum of 29.2 MJ/h.	760 mm
Single burner gas cooktop with an output greater than 29.2 MJ/h.	Not possible

Adjusting the vapour shield

When retracted, the deflector plate is held in place by magnets.

The retaining force of the magnets can be adjusted. The magnets should be adjusted such that the deflector plate is held in place securely on the left and right hand side and can be lowered slightly.

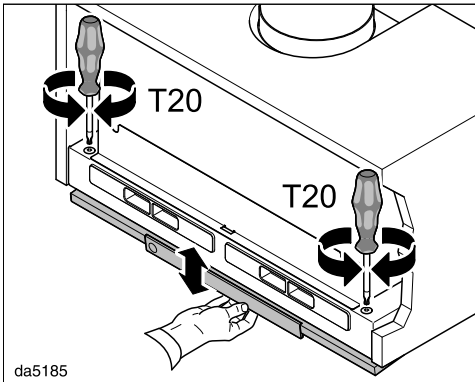

- Adjust both sides equally. Turn **in stages** by a half turn each time and check the adjustment by lowering and raising the deflector plate.
- Turning the adjusting screws clockwise increases the magnetic retaining force.
- Turning the adjusting screws anti-clockwise reduces the magnetic retaining force.

Installation

Connection for air extraction

 Before installation, it is important to read the information given on the following pages as well as the "Appliance dimensions" and the "Warning and Safety instructions" at the beginning of this booklet. This is particularly crucial when using the rangehood at the same time as a heating appliance that relies on oxygen from the same room, which could result in the build-up of toxic fumes.

The rangehood should be installed according to local and national building regulations. Seek approval from the building inspector where necessary.

Only use smooth pipes or flexible ducting made from approved non-flammable materials for exhaust ducting.

To achieve the most efficient air extraction with the lowest noise levels, please note the following:

- The diameter of the exhaust ducting must not be smaller than the cross-section of the exhaust connection (see "Appliance dimensions"). This is particularly applicable when using flat ducting.
- The exhaust ducting must be as short and straight as possible.
- Only use wide radius bends.
- The exhaust ducting must not be kinked or compressed.
- All connections must be strong and airtight.

- If the ducting has flaps, these must be opened when the rangehood is switched on.

Any constriction of the airflow will reduce extraction performance and increase operating noise.

Vent flue

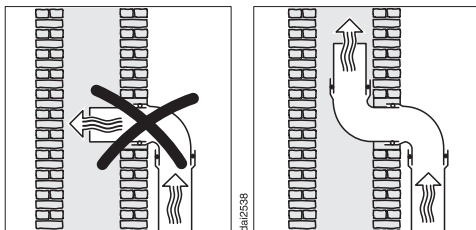

If the exhaust air is to be ducted into a vent flue, the ducting must be directed in the flow direction of the flue.

If the flue is used by several ventilation units, the cross-section of the flue must be large enough.

Non-return flap

- Make sure you use a non-return flap in the exhaust air system.

A non-return flap ensures that when the rangehood is not in operation, the duct is closed and no exchange of room and outside air can take place.

If the exhaust air is ducted through an outside wall, a Miele wall vent or a Miele roof vent (available as an optional accessory) is recommended. These are fitted with an integrated non-return flap.

If the on-site exhaust air system does not have a non-return flap, one is supplied with the rangehood.

The non-return flap is fitted to the fan's exhaust connection.

Condensed water

If the exhaust ducting is to run through rooms, ceiling space etc., condensate may form in the ducting due to variations in temperature between the different areas. To minimise temperature variations, the exhaust ducting will need to be suitably insulated.

Where ducting is horizontal, it must be laid to slope away at at least 1 cm per metre. The gradient ensures that condensate cannot drain back into the rangehood.

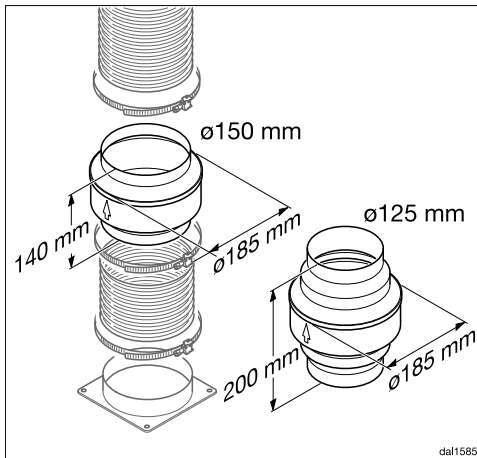

In addition to insulating the exhaust ducting, we recommend that a suitable condensate trap is also installed to collect and evaporate any condensate which may occur.

Condensate traps are available for 125 mm or 150 mm ducting.

When installing a condensate trap, ensure that it is positioned vertically and, if possible, directly above the exhaust socket. The arrow on the housing indicates the direction of airflow.

Miele will not accept warranty claims for any functional defects or damage caused by inadequate ducting.

Silencer

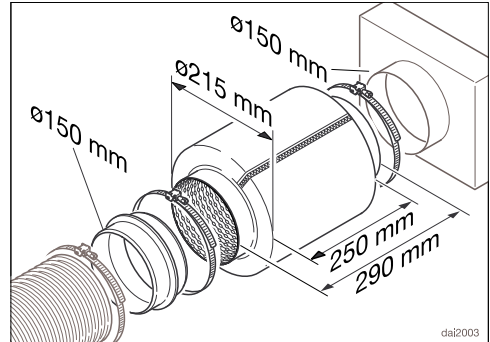

To achieve even further reductions in noise levels, a special silencer (optional accessory) can be fitted in the ducting system.

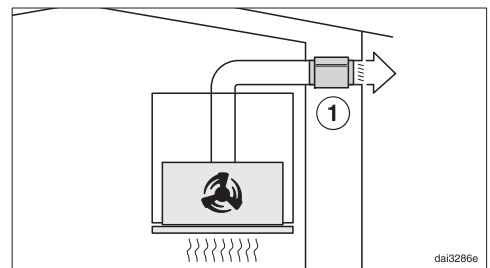

In extraction mode the silencer not only reduces noise from the fan outside the house, but also sounds from outside which reach the kitchen via the vent ducting (e.g. traffic noise). For this reason, the silencer must be positioned as close as possible to the ducting exit ①.

Installation

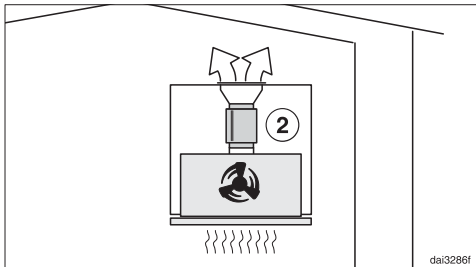

In recirculation mode the silencer needs to be positioned between the exhaust connection and the exhaust grille ②. Please ensure there is adequate installation space.

Electrical connection

The rangehood is supplied with a mains connection cable with moulded plug ready for connection to a suitable earthed socket.

If the socket is not easily accessible or if the appliance is to be hard-wired, ensure that a suitable means of disconnection is provided on the installation side for each pole.

⚠ Risk of fire from overheating.
Connecting the rangehood to multi-socket adapters or extension cables can overload the cables.
For safety reasons, do not use an extension cable or multi-socket adapter.

All electrical work must be carried out by a suitably qualified and competent person in strict accordance with national and local safety regulations.

For safety reasons, we recommend using a suitable residual current device (RCD) in the relevant electrical installation for connecting the rangehood.

If the mains connection cable is damaged, it must only be replaced with a specific mains connection cable of the same type (available from Miele). For safety reasons, such replacement may only be carried out by a suitably qualified and competent electrician or a Miele authorised service technician, in order to avoid a hazard.

The data plate indicates the nominal power consumption and the connection data. Compare this information with the data of the on-site electrical connection. If in any doubt, consult a qualified electrician.

Temporary or permanent operation with a self-sufficient or non-mains synchronous energy supply system (e.g. isolated networks, back-up systems) is possible. A requirement for the operation is that the energy supply system complies with all current local and national requirements that apply to stand-alone, solar and/or battery systems. The protective measures provided in the domestic installation and in this Miele product must also be assured in their function and operation in isolated operation or in non-mains synchronous operation, or replaced with equivalent measures in the installation.

Technical data

Fan motor	290 W
Cooktop lighting	3 W
Total rated load	293 W
Voltage, frequency	AC 230 V, 50 Hz
Fuse rating	10 A
Mains connection cable length	1.5 m
Weight	
DAS 8630	15 kg
DAS 8930	19 kg

Optional accessory for recirculation mode

For recirculation operation, you need the DUU 150 or DUU 151 kit and the DKF 31-P or DKF 31-R charcoal filters (reactivatable). The packs contain 2 charcoal filters.

Miele Australia Pty. Ltd.

ACN 005 635 398

ABN 96 005 635 398

Level 4, 141 Camberwell Road
Hawthorn East, VIC 3123

1300 464 353 (1300 4 MIELE)

info@miele.com.au

www.miele.com.au

Miele New Zealand Limited

IRD 98 463 631

8 College Hill
Freemans Bay, Auckland 1011

0800 464 353 (0800 4 MIELE)

customercare@miele.co.nz

www.miele.co.nz

Miele Global Headquarters

Germany

Miele & Cie. KG

Carl-Miele-Straße 29

33332 Gütersloh

Federal Republic of Germany

DAS 8630, DAS 8930

en-AU, NZ

M.-Nr. 12 039 300 / 01