



Quick Start Guide Commercial tumble dryers PDR 511 HP PDR 516 EL/G

To avoid the risk of accidents or damage to the machine, it is **essential** to read these instructions before it is installed and used for the first time.

en-GB

Contents

Warning and Safety instructions	4
Extended documentation	4
Appropriate use	4
Foreseeable misuse	5
Technical safety	6
Gas-heated tumble dryers	8
Correct use.....	8
Description of the machine	10
PDR 511 SL (with heat pump)	10
PDR 516 SL (electrically heated)	11
PDR 516 SL (gas heated)	12
Operating the tumble dryer	13
Machines with residual moisture control (ROP)	13
Drying levels	13
Drying programmes.....	14
Machines with time control (TOP)	15
Drying levels (TOP).....	15
Timed programmes	16
Machines with payment systems (COP).....	17
Drying programmes.....	17
How the control field works.....	19
Indicators	19
Drying	20
1. Notes on correct laundry care	20
Washing before drying	20
Preparing the laundry	20
Removing foreign objects.....	20
2. Loading the tumble dryer.....	22
3. Selecting a programme	23
Selecting a programme.....	23
Care symbols.....	23
Drying level for programmes with a selectable drying level	23
Time-controlled and other programmes	23
Selecting the Delay start function.....	23
4. Starting a programme	25
5. Unloading laundry from the tumble dryer	26
End of the programme	26
Removing the laundry	26
Care notes	26
Programme overview	27
“Label” programme package	27
“Standard” programme package	28
Installation	29
Installation requirements	29
General operating conditions	29
Transporting the tumble dryer	29
Installing the tumble dryer.....	30
Electrical connection	31

Installation of electrically heated and gas-heated variants	33
Air intake/exhaust air	33
Gas connection (only for gas-heated variants)	35
Installation of variants with heat pumps	43
General operating conditions	43
Transport	43
Air intake vent	43
Air outlet vent	43
Condensate drainage point	44
Connectivity	45
Pairing instructions	45
Technical data	46
Technical data	47
Technical data	47
UK declaration of conformity	47

Warning and Safety instructions

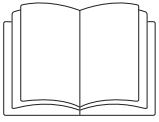

- It is essential to read these instructions.

Extended documentation

This document contains essential information. You can access the full operating instructions and other up-to-date documentation for your appliance on the Miele website:

<https://www.miele.co.uk/professional/user-manuals-177.htm>



In order to access the documentation, you will need the model number or serial number for your appliance. This information can be found on the appliance's data plate.

This tumble dryer complies with all current local and national safety requirements. However, inappropriate use can lead to personal injury and damage to property.

Read the operating instructions carefully before using the tumble dryer. They contain important information on safety, installation, use and maintenance. This prevents both personal injury and damage to the tumble dryer.

In accordance with standard IEC 60335-1, Miele expressly and strongly advises that you read and follow the instructions in the chapter on installing the tumble dryer as well as the safety instructions and warnings.

Miele cannot be held liable for damage caused by non-compliance with these instructions.

Keep these operating instructions in a safe place and pass them on to any future owner.

When instructing other people how to use the tumble dryer, they must be made aware of these safety and warning instructions.

Appropriate use

This tumble dryer complies with current safety requirements. Inappropriate use can, however, lead to personal injury and damage to property.

It is essential to read these operating instructions before using the tumble dryer for the first time. They contain important information for your safety, as well as information on using and maintaining the tumble dryer. This prevents both personal injury and damage to the machine.

- The tumble dryer is intended for installation in a commercial environment.
- This tumble dryer is only intended for drying fabrics which have been washed in a water solution, and marked on the manufacturer's care label as being suitable for tumble drying. "Dry cleaning kits" for freshening up garments in a tumble dryer are increasingly available on the market. If using, do so at your own risk, and follow the instructions provided on the packaging. Any other applications may be dangerous. Miele cannot be held liable for damage resulting from incorrect or improper use or operation.

Warning and Safety instructions

- ▶ The tumble dryer is not intended for outdoor use.
- ▶ The tumble dryer must not be used in a non-stationary location (e.g. on a ship).
- ▶ Do not install the tumble dryer in a room where there is a risk of frost. At temperatures around freezing point, the tumble dryer may not be able to operate properly.
A room temperature between 2 °C and 40 °C is permitted for electrically heated and gas-heated tumble dryers.
A room temperature between 10 °C and 40 °C is permitted for tumble dryers with heat pumps.
- ▶ If the machine is used in a commercial environment it may only be operated by instructed/trained personnel. If the machine is used in a publicly accessible area, the supervisor must ensure that it can be operated safely without risk of danger.
- ▶ This appliance can only be used by people with reduced physical, sensory or mental capabilities, or lack of experience or knowledge, if they are supervised whilst using it or have been shown how to use it in a safe way and understand and recognise the consequences of incorrect operation.
- ▶ Children under 8 years of age must be kept away from the tumble dryer unless they are constantly supervised.
- ▶ Children 8 years and older may only use the tumble dryer unsupervised if they have been shown how to use it safely and recognise and understand the consequences of incorrect operation.
- ▶ Children must not be allowed to clean or maintain the tumble dryer unsupervised.
- ▶ Please supervise children in the vicinity of the tumble dryer and do not let them play with it.
- ▶ This tumble dryer may also be operated in public areas.
- ▶ Any uses other than those listed above are prohibited. The manufacturer accepts no liability in such cases.

Foreseeable misuse

- ▶ Do not make any alterations to the tumble dryer, unless authorised to do so by Miele.
- ▶ In the case of parts that have been sealed by Miele, the seals must not be broken. If these seals need to be broken in order to carry out a repair or conversion, they must be replaced following the inspection.
- ▶ Do not lean on the tumble-dryer door. Otherwise, the tumble dryer may tip over, causing injury to yourself or others.
- ▶ Do not use a pressure washer or water jet to clean the tumble dryer.
- ▶ The tumble dryer must be serviced in a timely and professional manner. Otherwise, there is a potential risk of loss in performance, faults and fire.
- ▶ Benzine, petrol, paraffin, or any easily flammable liquid must not be stored or used near the machine. Danger of explosion.
- ▶ Do not expose the dryer to air which is contaminated with vapour of chlorine, fluorine or other solvents. Danger of fire.

Warning and Safety instructions

- ▶ To prevent the risk of fire, the following items must not be dried in this tumble dryer:
 - Items which have not been washed.
 - Items which have not been thoroughly cleaned and are still soiled with grease, oil or other deposits (such as kitchen linens or cosmetics cloths with cooking oils, grease, lotions, etc). If items have not been thoroughly cleaned, there is a danger that they might ignite when heated, even after they have been removed from the tumble dryer at the end of the programme.
 - Items (e.g. mops and floor cloths) that have been treated with inflammable cleaning agents or which contain residues of acetone, alcohol, benzene, petrol, kerosene, stain remover, turpentine, wax and wax remover or other chemicals.
 - Items which have been splashed with hair lacquer, hair spray, nail varnish remover or similar substances.

Wash heavily soiled items thoroughly by increasing the amount of detergent and selecting a high washing temperature. If in doubt, wash the items several times.

- ▶ Danger of squashing or cutting fingers etc. around the drum door hinges and the fluff filter cover. Use the appropriate handles and release catches only.
- ▶ Always make sure that the drum is stationary before reaching in to remove laundry. Do not touch the drum whilst it is still rotating.
- ▶ In many programmes, the heating phase is followed by a cooling down phase to ensure that the items are not too hot to handle when you remove them (this also avoids the danger of the laundry self-igniting). The programme is not finished until the cooling down phase is complete. Ensure that you always wait until the end of the programme before removing the laundry.

Technical safety

- ▶ This tumble dryer must only be set up and commissioned by a Miele Service technician or authorised Miele Service Dealer.
- ▶ Before installation check the tumble dryer for any obvious damage. A damaged tumble dryer must not be installed and/or used.
- ▶ Do not connect the tumble dryer to the power supply by an extension lead (fire hazard due to overheating).
- ▶ Do not operate the tumble dryer in a room where cleaning machines operate with solvents containing CFCs. During combustion, any vapours that are emitted will break down into hydrochloric acid, leading to consequential damage affecting laundry and the machine. Air exchange must not take place between rooms if machines are set up in separate rooms.
- ▶ Fire hazard due to controllable socket. This tumble dryer must not be connected to a controllable socket (e.g. a timer). There is a risk of the laundry self-igniting if the tumble dryer's cooling phase is interrupted.
- ▶ The electrical safety of this tumble dryer can only be guaranteed when correctly earthed. It is essential that this standard safety requirement is met. If in any doubt, please have the on-site wiring system tested by a qualified electrician. Miele cannot be held liable for the consequences of an inadequate earthing system (e.g. electric shock).
- ▶ The tumble dryer is only electrically disconnected from the power supply, if
 - the plug has been disconnected from the socket.
 - it is switched off at the main switch, or the mains electrical fuse is disconnected (on site).
- ▶ The plug must be easily accessible so that the tumble dryer can be disconnected from the power supply at any time. The operator must be able to check from any access point that the plug is still removed.

Warning and Safety instructions

- ▶ If the appliance is hard wired, adequate provision must be made on site to switch off all poles to disconnect the tumble dryer from the power supply.
- ▶ If the mains connection cable is faulty it must always be replaced by a Miele authorised technician to protect the user from danger.
- ▶ Tumble dryers with damage to the control panel or wire insulation must not be used until they have been repaired.
- ▶ Unauthorised repairs could result in unforeseen dangers for the user, for which Miele cannot accept liability. Repairs should only be undertaken by a Miele authorised technician, otherwise any subsequent damage will not be covered by the warranty.
- ▶ Faulty components may only be replaced by genuine Miele spare parts. Miele can only guarantee the safety standards of the appliance when Miele replacement parts are used.
- ▶ Only operate the tumble dryer when all removable outer panels are in place so that it is impossible to touch an electrical component or moving part.
- ▶ During the drying process, the door glass and the frame around the drum door will get hot. Please be aware that the laundry may also be hot if it is removed from the tumble dryer before the end of the drying programme.
- ▶ In the event of a fault and for cleaning and maintenance purposes, the tumble dryer must be disconnected from the power supply. The tumble dryer is only disconnected from the power supply, if:
 - It is switched off at the wall socket or the plug is withdrawn.
 - The mains fuse is disconnected.
 - The mains fuses have been completely removed.
- ▶ If the heater element malfunctions, accessible parts can get very hot.
- ▶ Only allow clean, fresh air to be fed into the tumble dryer. Air entering the machine must not contain vapours with chlorine, fluorine or other solvents.
- ▶ Electrically heated and gas-heated tumble dryers may only be operated when the vent ducting has been installed and the room is sufficiently ventilated. Vent ducting is not required for tumble dryers with heat pump.
- ▶ The vent ducting must never be installed in any of the following flues or shafts:
 - Chimneys or smokestacks that are in use.
 - Shafts that are used to ventilate installation rooms with fireplaces.
 - Flues that are used by third parties.

Smoke or exhaust gas that is fed back into the flue or shaft may be toxic.

▶ Regularly check all components in the vent ducting (e.g. wall pipe, external grille, bends, elbows, etc.) to make sure air can move through them and to ensure that they are working properly. Clean components when necessary. Fluff deposits in the vent ducting system will prevent the air from being extracted properly and, as a result, will stop the tumble dryer from working properly.

If existing vent ducting is due to be used, it must be checked before being connected to the tumble dryer.

Low pressure must not occur in the vent ducting.

▶ There is a risk of suffocation and poisoning due to exhaust gases being sucked back if gas-powered flow heaters, gas-powered room heaters, coal-burning stoves with a flue connection, etc., are installed in the same room, in the same flat or in neighbouring rooms and the negative pressure is 4 Pa or more.

The following measures for suitable room ventilation (examples) can help to prevent negative pressure in the installation area:

- Install suitably sized vents that cannot be closed in the exterior walls.

Warning and Safety instructions

Please always seek approval from your building regulations inspector to confirm that the appliance can be operated without risk and that negative pressure of over 4 Pa can be prevented.

▶ If multiple tumble dryers are to be connected to one vent ducting, a non-return flap must be installed directly on the duct for each tumble dryer.

If this requirement is not observed, the tumble dryers may be damaged and their electrical safety could be affected.

▶ Ensure that no closeable door, sliding door or an oppositely hinged door is installed that would hinder the drum door being opened in any way.

Gas-heated tumble dryers

▶ In the event of a fault or when carrying out cleaning and maintenance, the on-site manual gas shut-off valve and the shut-off device on the gas meter must be closed.

▶ Before completing commissioning, maintenance, conversion and repair work, all gas-conducting components – from the manual shut-off valve to the burner jet – must be checked for leaks. Particular attention must be paid to the measurement connections on the gas valve and on the burner. Checks must be performed when the burner is both switched on and switched off.

▶ Carry out an annual visual inspection of the gas lines and gas appliances in your property. This inspection must comply with applicable national regulations.

Take these safety precautions if you smell gas

- Extinguish all flames immediately.
- Close the on-site gas shut-off device, the gas shut-off device on the gas meter or the main gas shut-off device immediately.
- Open all windows and doors immediately.
- Do not light any naked flames (e.g. matches or lighters).
- Do not smoke.
- If there is the smell of gas in a room, never enter the room with a naked flame.
- Do not carry out any actions that will create electrical sparks (such as pulling out electrical plugs or pressing electrical switches or bells).
- If you cannot find the cause of the gas smell and all gas valves have been shut off, please call the gas supply company immediately.

If other persons are being shown how to operate the appliance, they must be given and/or made aware of these important safety precautions.

Correct use

▶ Do not damage, remove or bypass the safety features and control elements of the tumble dryer.

▶ Always close the drum door after each drying cycle. This will prevent:

- Children climbing into the tumble dryer or hiding things in it.
- Pets or other small animals climbing into the tumble dryer.

▶ Keep the room where the tumble dryer is located free from dust and fluff. If the air that is taken into the machine contains dirt particles, this can cause blockages. A fault may then occur and there is a risk of fire.

▶ Never operate the tumble dryer without the fluff filter or with a damaged fluff filter. This could lead to malfunctions. Fluff can clog the air channels, heating elements and vent ducting, which could result in a fire. In this case, stop the tumble dryer immediately and replace the damaged fluff filter.

Warning and Safety instructions

- ▶ The fluff filter must be cleaned on a regular basis.
- ▶ To ensure problem-free operation of the tumble dryer:
 - Clean the surface of the fluff filter after each drying cycle.
 - In addition, the fluff filter and the air passages must be cleaned when prompted by the display.
- ▶ Remove all items from the pockets of the laundry to be dried (e.g. lighters, matches, keys).
- ▶ The programme ends when the cooling phase starts. Many programmes are followed by the cooling phase to ensure that the items of laundry are kept at a temperature that will not cause them damage (for instance to prevent the risk of the laundry self-igniting). Always remove all items of laundry from the tumble dryer immediately after the cooling phase.
- ▶ Accessory parts may only be fitted when expressly approved by Miele. If other parts are used, warranty, performance and product liability claims will be invalidated.

 Miele cannot be held liable for damage caused by non-compliance with these Warning and Safety instructions.

Description of the machine

PDR 511 SL (with heat pump)

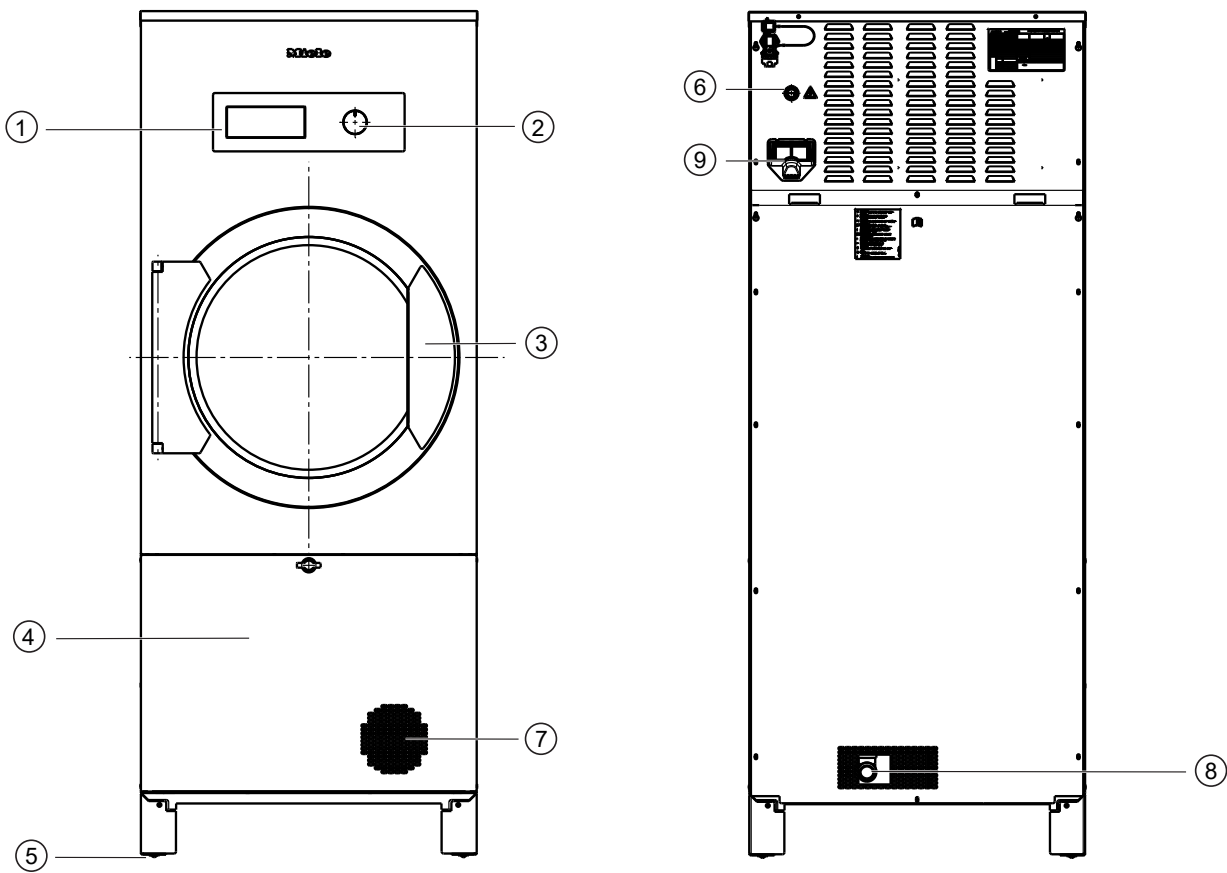

① **Control panel**

② **Rotary control**

Turn the rotary control to switch on the tumble dryer and select the drying programme.

③ **Drum door**

The drum door is opened by pulling the door handle.

④ **Fluff filter compartment cover with handle**

The fluff filter compartment cover is opened by turning the handle. The fluff filter is behind the fluff filter compartment.

⑤ **Screw foot (4 feet)**

To ensure that the tumble dryer is aligned, its height can be adjusted by turning the feet.

⑥ **Electrical connection**

The permitted supply voltage is specified on the data plate of the tumble dryer.

⑦ **Air intake vent**

⑧ **Condensate drainage**

⑨ **Communication slot for communication module**

PDR 516 SL (electrically heated)

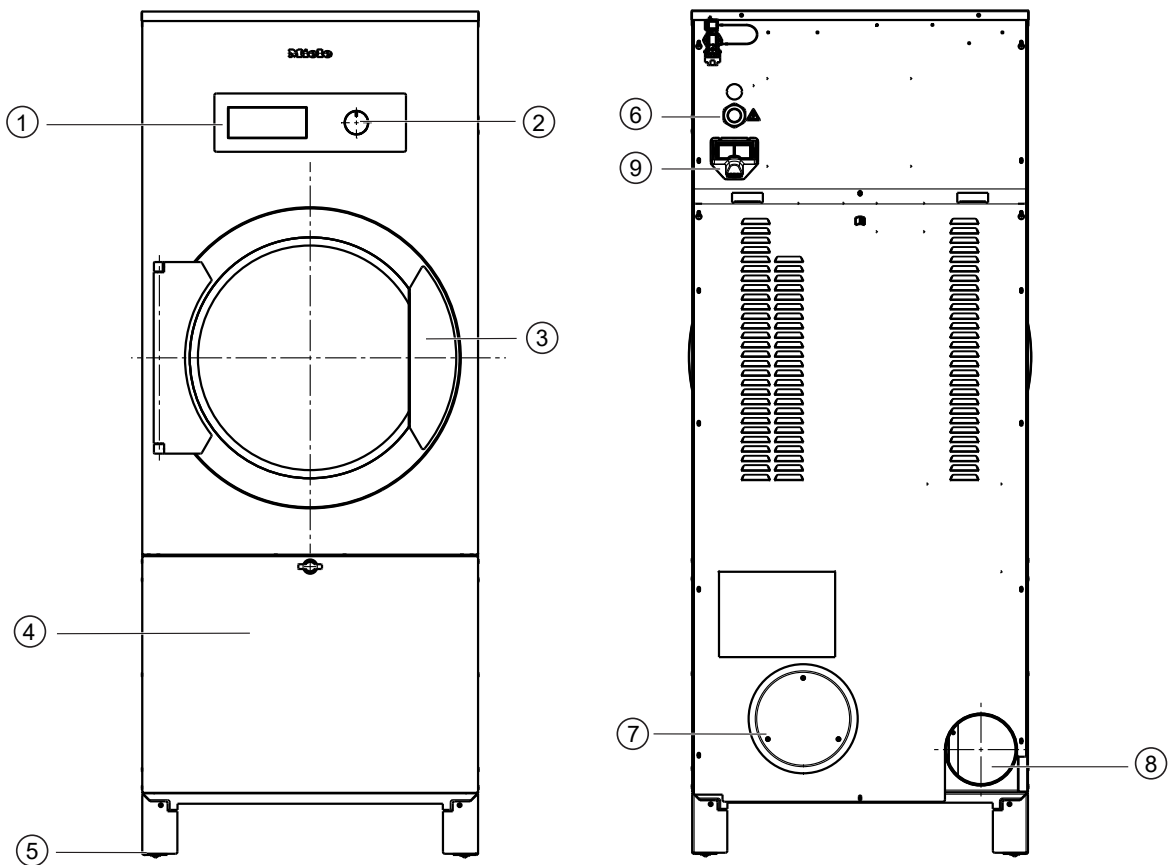

① **Control panel**

② **Rotary control**

Turn the rotary control to switch on the tumble dryer and select the drying programme.

③ **Drum door**

The drum door is opened by pulling the door handle.

④ **Fluff filter compartment cover with handle**

The fluff filter compartment cover is opened by turning the handle. The fluff filter is behind the fluff filter compartment.

⑤ **Screw foot (4 feet)**

To ensure that the tumble dryer is aligned, its height can be adjusted by turning the feet.

⑥ **Electrical connection**

The permitted supply voltage is specified on the data plate of the tumble dryer.

⑦ **Air intake vent**

⑧ **Exhaust duct**

⑨ **Communication slot for communication module**

Description of the machine

PDR 516 SL (gas heated)

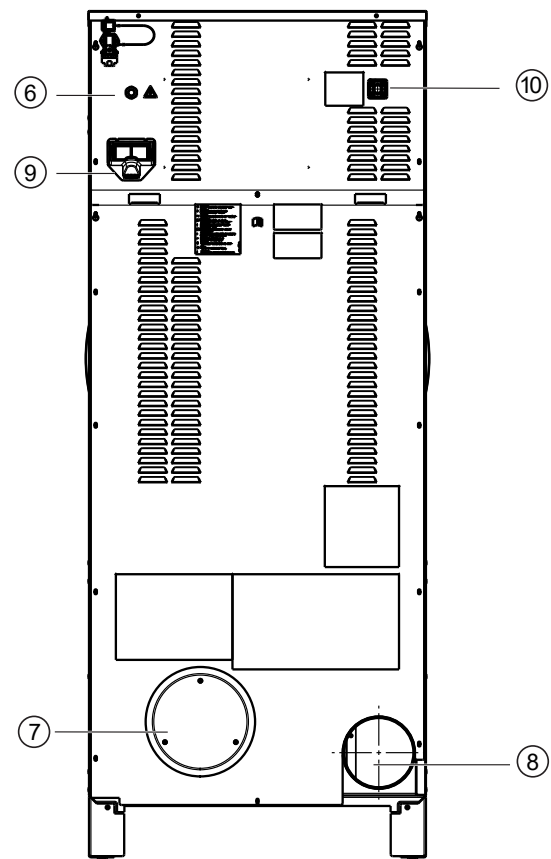
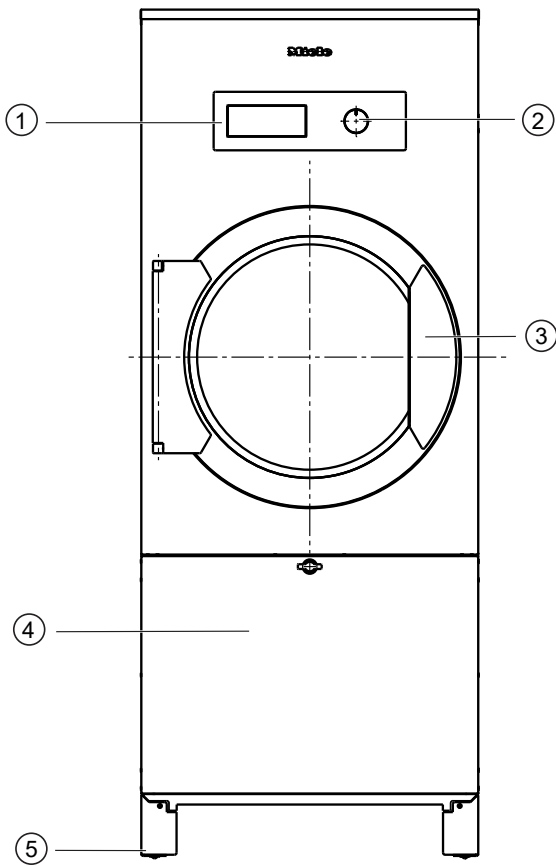

① **Control panel**

② **Rotary control**

Turn the rotary control to switch on the tumble dryer and select the drying programme.

③ **Drum door**

The drum door is opened by pulling the door handle.

④ **Fluff filter compartment cover with handle**

The fluff filter compartment cover is opened by turning the handle. The fluff filter is behind the fluff filter compartment.

⑤ **Screw foot (4 feet)**

To ensure that the tumble dryer is aligned, its height can be adjusted by turning the feet.

⑥ **Electrical connection**

The permitted supply voltage is specified on the data plate of the tumble dryer.

⑦ **Air intake vent**







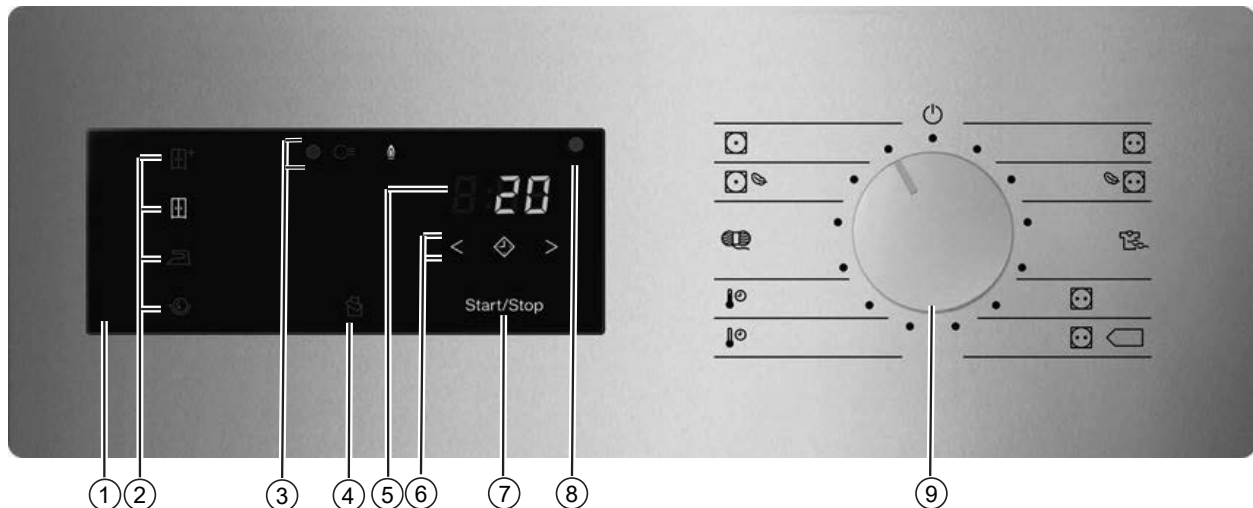

⑧ **Exhaust duct**

⑨ **Communication slot for communication module**





⑩ **Gas connection**

Machines with residual moisture control (ROP)















- ① **Control field**
- ② **Sensor controls for the drying levels**
- ③ **Status displays**   
Light up when necessary.
- ④  **sensor control**
Activates the Intermittent fan operation to perfectly dry light fabrics, e.g. bed linen and cloths. The function is deactivated as a factory default setting and can only be activated and set by the Miele Customer Service Department.
- ⑤ **Time display 8:88**
Displays the remaining programme running time in hours and minutes.
- ⑥   **sensor controls**
For the Delay start function. After touching the  sensor control, a later start time for the programme (Delay start) can be selected. The  sensor control lights up brightly when selected.
The duration of the Delay start period is selected by touching the < or > sensor control.
- ⑦ **Start/Stop sensor control**
For starting the selected drying programme and cancelling a programme once it has started. The programme selected can be started as soon as the sensor control starts flashing.
- ⑧ **Optical interface**
Used for data transfer by the Customer Service Department.
- ⑨ **Programme selector**
For selecting programmes and for switching the machine off. The tumble dryer is switched on when you select a programme and switched off by turning the programme selector to the  position.

Drying levels

-  sensor control = "Normal plus"
-  sensor control = "Normal"
-  sensor control = "Hand iron"
-  sensor control = "Machine iron"
-  sensor control: "Duvets" function









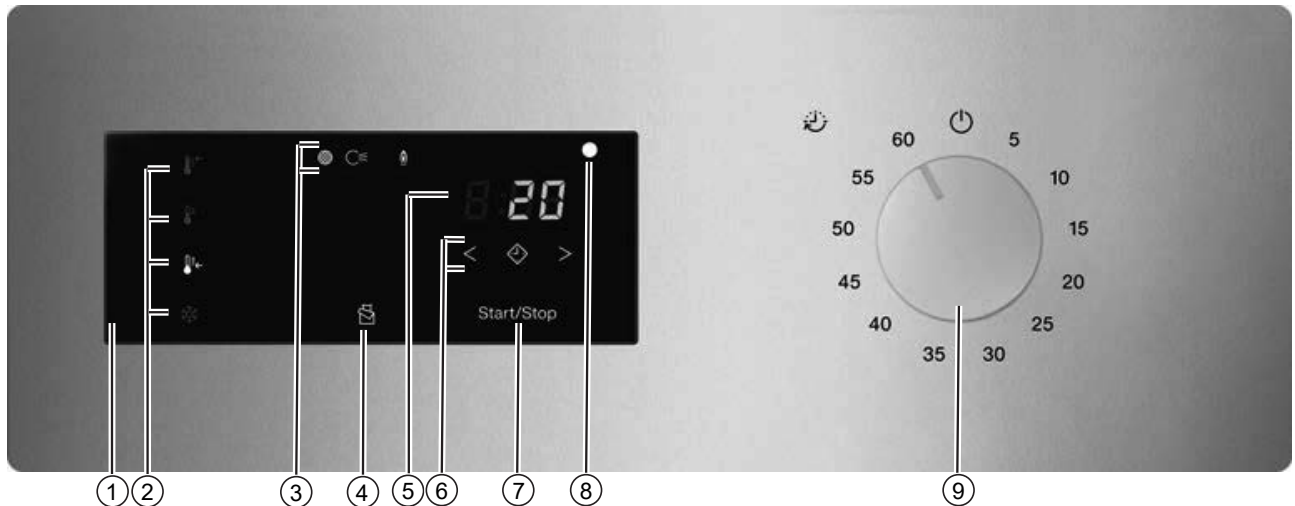



Operating the tumble dryer

Drying programmes





-  position = “Cottons” programme
For drying cotton and linen fabrics.
-  position = “Cottons Low temperature” programme
For drying delicate cotton and linen fabrics.
-  position = “Synthetics/Delicates” programme
For drying synthetic fibres and artificial silk to 20 % residual moisture.
-  PRO position = “Label programme” programme
-   position = “Label programme” programme
-  position = “Timed drying cool air” programme
For airing fabrics with 10 minutes of drying time.
-  position = “Timed drying warm air” programme
For drying fabrics at high temperatures and with 20 minutes of drying time
-  position = “Woollens” programme
For drying woollens with 5 minutes of drying time.
-   position = “Minimum iron Low temperature” programme
-  position = “Minimum iron” programme
-  position = machine off

Machines with time control (TOP)



- ① **Control field**
- ② **Sensor controls for the drying levels**
- ③ **Status displays**   
Light up when necessary.
- ④  **sensor control**
Activates the Intermittent fan operation to perfectly dry light fabrics, e.g. bed linen and cloths. The function is deactivated as a factory default setting and can only be activated and set by the Miele Customer Service Department.
- ⑤ **Time display 8:20**
Displays the remaining programme running time in hours and minutes.
- ⑥    **sensor controls**
For the Delay start function. After touching the  sensor control, a later start time for the programme (Delay start) can be selected. The  sensor control lights up brightly when selected.
The duration of the Delay start period is selected by touching the  or  sensor control.
- ⑦ **Start/Stop sensor control**
For starting the selected drying programme and cancelling a programme once it has started. The programme selected can be started as soon as the sensor control starts flashing.
- ⑧ **Optical interface**
Used for data transfer by the Customer Service Department.
- ⑨ **Time selector**
For selecting times and for switching the machine off. The tumble dryer is switched on when you select a time and switched off based on the position of the time selector .

Drying levels (TOP)

-  sensor control = "high" temperature setting
-  sensor control = "medium" temperature setting
-  sensor control = "low" temperature setting
-  sensor control = "cool" temperature setting

Operating the tumble dryer

Timed programmes

- 5 position = Timed drying: 05 minutes
- 10–55 position = Timed drying: 10–55 minutes
- 60 position = Timed drying: 60 minutes
-  position = machine off

Machines with payment systems (COP)

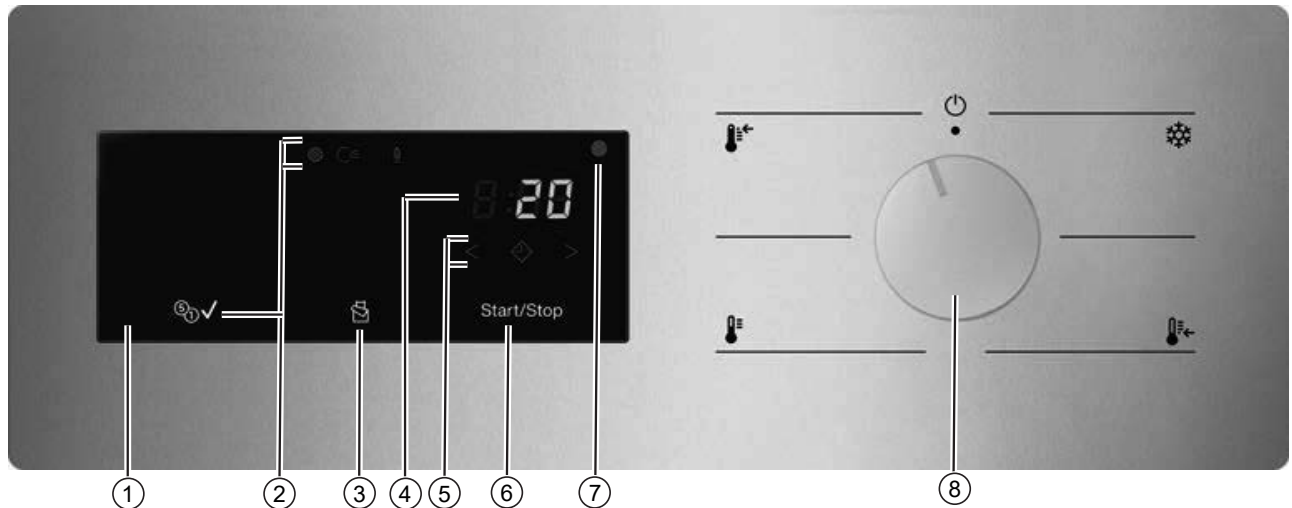

① **Control field**

② **Status displays** 🌐 ⏸ 🔥 ✓
Light up when necessary.

③ **sensor control**
Activates the Intermittent fan operation to perfectly dry light fabrics, e.g. bed linen and cloths. The function is deactivated as a factory default setting and can only be activated and set by the Miele Customer Service Department.

④ **Time display 8:88**
Displays the remaining programme running time in hours and minutes.

⑤ **< > sensor controls**
For the Delay start function. After touching the sensor control, a later start time for the programme (Delay start) can be selected. The sensor control lights up brightly when selected.
The duration of the Delay start period is selected by touching the < or > sensor control.

⑥ **Start/Stop sensor control**
For starting the selected drying programme and cancelling a programme once it has started. The programme selected can be started as soon as the sensor control starts flashing.

⑦ **Optical interface**
Used for data transfer by the Customer Service Department.

⑧ **Temperature setting selector**
For selecting temperature settings and for switching the machine off. The tumble dryer is switched on when you select a temperature setting and switched off at temperature selector setting .

Drying programmes

- position range = cool temperature setting
For airing fabrics.
- position range = “low” temperature setting
For drying delicates made from artificial silk or synthetic fibres.
- position range = “medium” temperature setting
For drying easy-care synthetics and mixed fibres.

Operating the tumble dryer

- 🔥 position range = “high” temperature setting
For drying cotton and linen fabrics.
- ⏻ position = machine off

How the control field works

The sensor controls react to fingertip contact. If a sensor control is lit, it can be selected.





If a sensor control is brightly lit, this means it is currently selected.

If a sensor control is dimly lit, this means it can be selected.





Sensor controls for the drying levels

After selecting a drying level programme with the programme selector, the recommended drying level lights up. Drying levels that can be selected are dimly lit.





Drying levels

-  sensor control = "Normal plus"
-  sensor control = "Normal"
-  sensor control = "Hand iron"
-  sensor control = "Machine iron"





Drying levels (TOP)

-  sensor control = "high" temperature setting
-  sensor control = "medium" temperature setting
-  sensor control = "low" temperature setting
-  sensor control = "cool" temperature setting

Drying levels in payment system operation

-  sensor control = "high" temperature setting
-  sensor control = "medium" temperature setting
-  sensor control = "low" temperature setting
-  sensor control = "cool" temperature setting

Indicators

-  indicator light: lights up when the fluff filter needs cleaning.
-  indicator light: lights up if a fault is present in the ducting.
-  indicator light (gas-heated machines only): lights up when the heating is active.
-  indicator light (machines with payment system only): lights up when payment has been made.
-  time display: the remaining programme running time is displayed in hours and minutes. With most programmes, the duration displayed may vary or "jump". The following factors, among others, affect the programme duration displayed: the quantity of laundry, the type of fabric and the residual moisture in the laundry. The electronic module adapts to these parameters and then adjusts the programme duration with increasing accuracy.

Drying

1. Notes on correct laundry care

Washing before drying

Heavily soiled laundry must be washed particularly thoroughly. Use sufficient detergent and select a high wash temperature. If in doubt, wash the items several times.

The tumble dryer must not be used for drying items of laundry which have been cleaned using industrial chemicals.

New and coloured items must be washed thoroughly and separately. Do not dry new and coloured items with light coloured garments. There is the risk of colours running and discolouring other garments or even plastic components in the tumble dryer. Dark coloured fluff can also settle on light coloured garments and vice versa.

Preparing the laundry

Not all fabrics are suitable for drying in a tumble dryer. Please observe the symbols on the fabric care label.

Observe the instructions on the laundry care label:

- ☉ Dry at normal temperature
- ☺ Dry at low temperature
- ☒ Do not tumble dry

Tip: For even drying results and to avoid damaging fabrics, sort the laundry by fibre and weave.

⚠ Fire hazard due to drying unsuitable fabrics.
Machine drying unsuitable textiles poses a fire hazard.
Only tumble dry items that have a care label stating that they are suitable for tumble drying.

The following fabrics must not be dried in a tumble dryer:

- Fabrics which contain a large proportion of rubber, foam rubber or rubber-like materials.
- Fabrics treated with inflammable cleaning agents.
- Items which have been splashed with hair lacquer, hair spray, nail varnish remover or similar substances.
- Items soiled with oil, grease and similar residues, e.g. kitchen linen and linen used in beauty clinics.
- Items such as mop heads and floor cloths containing residual wax or chemicals.
- Damaged items that contain fillings, e.g. pillows and jackets.
- Fabrics contaminated by greases and oils that have not been adequately washed. Use a heavy-duty detergent for very heavily soiled items (e.g. workwear). Please seek advice from the detergent and cleaning agent manufacturer in this regard.

Removing foreign objects

Before drying, ensure that there are no foreign objects in the laundry.

⚠ Damage due to foreign objects which were not removed from the laundry.
Foreign objects in the laundry can melt, burn or explode.
Ensure that any foreign objects (e.g. detergent dispensing aids, lighters, etc.) have been removed from the laundry.

Check seams and stitching to ensure that the items of laundry are intact. This way you will avoid the danger of fillings coming out and causing a fire. Sew in or remove underwiring from bras.

 Risk of fire due to incorrect use and operation.
The laundry can burn and destroy the tumble dryer and the surroundings.
See the section on “Warnings and safety notes” for further information.

2. Loading the tumble dryer

Loading the laundry

⚠ Damage to fabrics caused by incorrect laundry care. Incorrect laundry care can damage fabrics during tumble drying. Before loading the dryer, read “1. Notes on correct laundry care”.

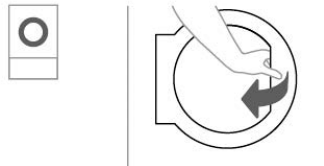

- Open the door.

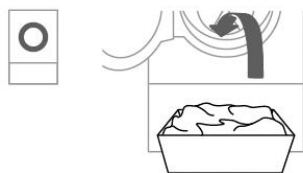

- Load the washed laundry into the tumble dryer.

Do not overload the drum. Overloading the drum will cause unnecessary wear and tear to the laundry and affect the drying results. This can also increase the creasing in the laundry.

Closing the door

⚠ Damage caused by laundry getting trapped. Laundry can be damaged by getting trapped when closing the door. When closing the door, make sure that laundry does not get trapped in the door opening.

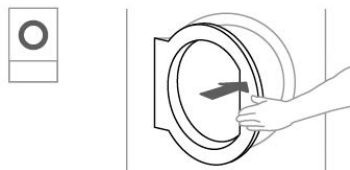

- Shut the door gently.

3. Selecting a programme







Selecting a programme

The tumble dryer is switched on by selecting a programme and switched off by turning the programme selector to the  position.

- Turn the programme selector to the required programme.

A drying level may also light up and durations will appear in the time display.

Care symbols

Drying	
	Normal/higher temperature (see control panel: "Cottons" programme)
	Low temperature (see control panel: "Minimum iron" programme)
	Do not tumble dry
Ironing	
	Very hot
	Hot
	Hot
	Do not iron

Drying level for programmes with a selectable drying level

The pre-set drying level can be changed if required.

- Touch the sensor control for the drying level you want. It then lights up brightly.

The drying levels that are available for selection depend on the selected programme.

Time-controlled and other programmes

Warm air

You can set the duration in one-minute increments from 0:20 minutes to 2:00 hours.

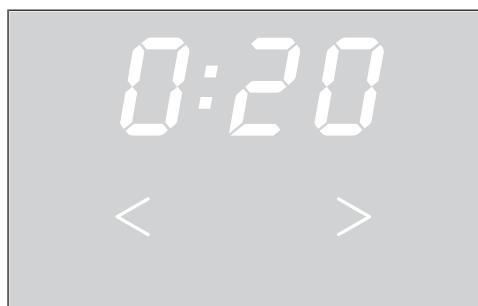

- Touch the < or > sensor control repeatedly until the required programme running time appears in the time display.





The drying result is preset by the tumble dryer and cannot be altered.



Selecting the Delay start function

With Delay start, you can delay the start of a programme from 0:30 minutes up to 24h (hours).



Drying



- Touch the  sensor control.
-  lights up brightly.
- Touch the  or  sensor control repeatedly until the required Delay start time appears in the time display.

Tip: The time will count upwards or downwards automatically if you touch the  or  sensor controls continuously.

Changing the Delay start time

- Touch the *Start/Stop* sensor control.
- Touch the  or  sensor control repeatedly until the required Delay start time appears in the time display.
- Touch the *Start/Stop* sensor control.

The Delay start function continues to count down.

Cancelling/deleting Delay start

- Turn the programme selector to the  position. Alternatively, you can also cancel Delay start by opening the door.

Delay start count-down

- Delay start times of more than *10h* will count down in hours and then in minutes until the start of the programme.
- The drum will turn briefly every hour until the start of the programme to reduce laundry creasing.

4. Starting a programme

Starting a programme

- Touch the flashing *Start/Stop* sensor control.

The *Start/Stop* sensor control will light up.

Programme sequence

- If Delay start has been selected, the Delay start time will start to count down first.
- The programme starts.

Programme running time/Time left estimation

The programme running time depends on the quantity of laundry, the type of fabric and the residual moisture in the laundry. The displayed programme running time for drying level programmes can therefore vary or “jump”. The tumble dryer’s electronic module adapts during the ongoing drying programme. The displayed programme running time becomes more and more accurate.

When using the programmes for the first time, the displayed time sometimes deviates significantly from the real time left. The difference between the estimated and achieved time becomes smaller if the corresponding programme is run more often. If different load sizes are dried in one programme, the time left display can only show an approximate time.

Laundry items and fabrics can wear out unnecessarily.
Avoid overdrying the laundry.

Energy saving

After a programmed time, the indicators dim. The *Start/Stop* sensor control flashes slowly.

- Touch the *Start/Stop* sensor control to switch the indicators back on.

Energy saving for the indicators will not affect a running programme.

- The laundry is cooled before the end of the programme in line with the setting in the programmable function.

5. Unloading laundry from the tumble dryer

End of the programme

The tumble dryer can be configured so that a buzzer sounds at the end of the programme.

At the end of the programme (0:00 is indicated on the time display), the laundry has cooled down and can be removed.

If *Anti-crease* has been selected, the drum keeps rotating at intervals. This reduces creasing if the laundry cannot be removed straight away.

The tumble dryer will switch off automatically after the programmed time after the end of a programme.

Removing the laundry

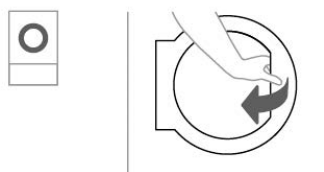

- Open the door.

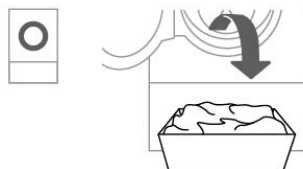

- Remove all of the laundry from the drum.

⚠ Damage caused by overdrying.
Laundry left in the dryer can be damaged by overdrying.
Always remove all items from the drum once drying has finished.

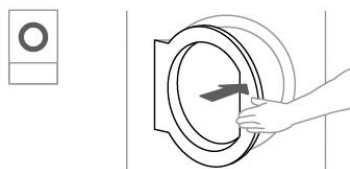





- Close the door.
- Switch the tumble dryer off.

Care notes

This tumble dryer requires regular maintenance, particularly if it is used on a continuous basis. Please see “Cleaning and care” for details.















“Label” programme package

Programme name	Suitable fabrics	Selectable drying levels (residual moisture in %)	Activatable extras	Maximum load size
 Cottons 	Cotton items with normal residual moisture	<ul style="list-style-type: none"> - Machine iron (40 %) - Hand iron (25 %) - Normal (0 %) - Normal plus (-2 %) 	-  Anti-crease*	PDR 511: 11 kg PDR 516: 16 kg
 Cottons PRO	Cotton items with normal residual moisture	<ul style="list-style-type: none"> - Machine iron (40 %) - Hand iron (25 %) - Normal (0 %) - Normal plus (-2 %) 	-  Anti-crease*	

* If the extra is activated in the programmable function at supervisor level.

Programme overview

“Standard” programme package

Programme name	Suitable fabrics	Selectable drying levels (residual moisture in %)	Activatable extras	Maximum load size
 Cottons	Single and multi-layer cotton/linen items	<ul style="list-style-type: none"> - Machine iron (40 %) - Hand iron (25 %) - Normal (0 %) - Normal plus (-2 %) 	-  Anti-crease*	PDR 511: 11 kg PDR 516: 16 kg
 Minimum iron	Minimum iron fabrics made of synthetic, cotton or mixed fibre	<ul style="list-style-type: none"> - Hand iron (20 %) - Normal (2 %) - Normal plus (0 %) 	-  Anti-crease*	PDR 511: 4.5 kg PDR 516: 6 kg
 Woolens	Woollen items	-	-	
 Delicates	Delicate synthetic, cotton or mixed fibre fabrics	<ul style="list-style-type: none"> - Hand iron (20 %) - Normal (2 %) - Normal plus (0 %) 	-  Anti-crease*	PDR 511: 2 kg PDR 516: 3 kg
 Timed drying cool air	Fabrics that need airing	-	-  Anti-crease*	
 Timed drying warm air	For drying small loads or for airing individual items	-	-  Anti-crease*	
 Cottons Low temperature	For drying small loads or for airing individual items	<ul style="list-style-type: none"> - Machine iron (40 %) - Hand iron (25 %) - Normal (0 %) - Normal plus (-2 %) 	-  Anti-crease*	PDR 511: 11 kg PDR 516: 16 kg
 Minimum iron Low temperature	Items suitable for tumble drying for which mechanical stress should be avoided.	<ul style="list-style-type: none"> - Hand iron (20 %) - Normal (2 %) - Normal plus (0 %) 	-  Anti-crease*	PDR 511: 4.5 kg PDR 516: 6 kg

* If the extra is activated in the programmable function at supervisor level.

Installation requirements

⚠ Risk of injury or damage to property due to improper installation.

Incorrect installation of the tumble dryer can lead to personal injury or damage to property.

The tumble dryer must only be installed and commissioned by Miele Customer Service Department or an authorised dealer.

- ▶ The tumble dryer must be installed in accordance with all relevant regulations and standards.
- ▶ The dryer must only be operated in a room that has sufficient ventilation and which is frost-free.
- ▶ The tumble dryer must not be installed behind a closeable door or a sliding door. The maximum opening angle of the tumble dryer door must not be limited by objects or doors. It must be possible to fully open the tumble dryer door at any time.

General operating conditions

This dryer is intended only for use in a commercial environment and must only be operated indoors.

Do not install the tumble dryer in a room where there is a risk of frost.

Depending on the nature of the installation site, sound emissions and vibrations may occur.

Tip: Have the installation site inspected and seek the advice of a professional in instances where increased noise may cause a nuisance.

Transporting the tumble dryer

⚠ Risk of injury caused by the tumble dryer tipping over.

When transporting the tumble dryer, there is the risk of the appliance tipping over.

The tumble dryer must only be transported with a transport pallet.

Suitable transport aids must always be used during transportation.

- Transport the tumble dryer to the installation site using a suitable pallet truck.
- Remove the transport packaging.

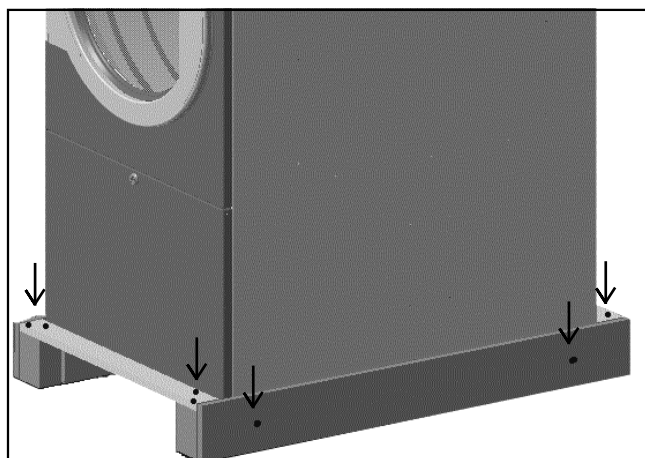

- Unscrew Torx screws (Torx T 20 and T 30) from the wooden pallet and remove the wooden battens.
- Remove the wooden battens.
- Lift the tumble dryer with the pallet truck.

Installation

- Fit the 4 adjustable feet supplied.

Installing the tumble dryer

- Place the tumble dryer on a perfectly level, secure and horizontal surface that is able to withstand the specified floor load.

The floor load created by the tumble dryer is concentrated and transferred to the installation surface via the machine feet. A base is not required. However, an uneven floor surface must be compensated for.

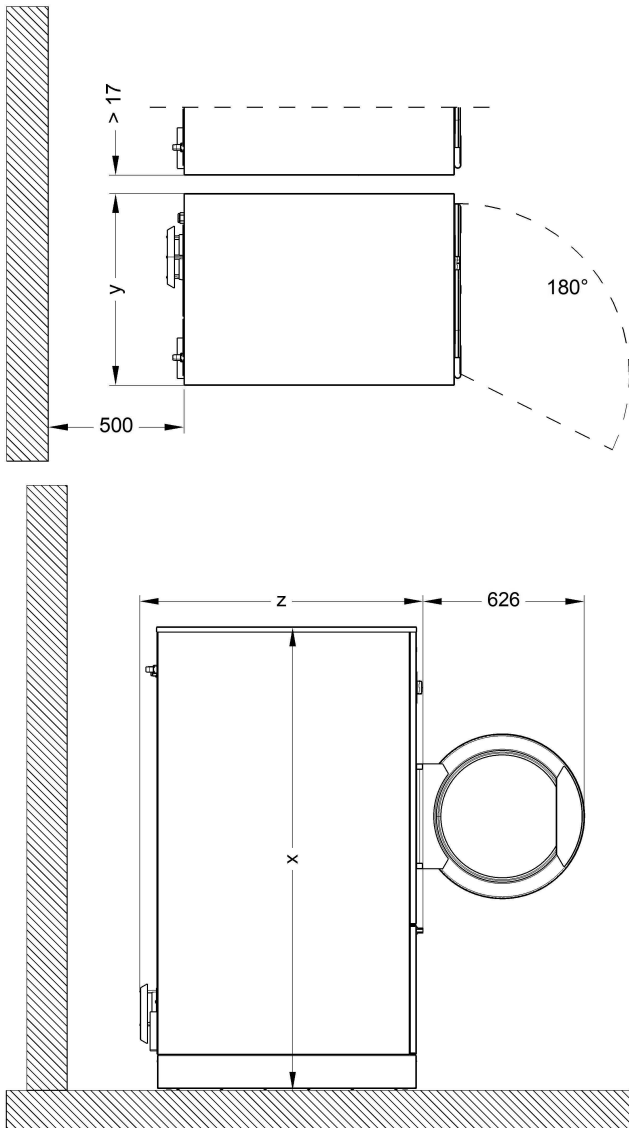

	PDR 516 SL
x	1800 mm
y	710 mm
z	1090 mm

- To ensure a sufficient flow of air to the machine and to facilitate any future maintenance work, a maintenance corridor with a width of at least 500 mm must be set up behind the machine and must be accessible at all times. The distance between the machine and any walls must not fall below the specified minimum values.

- The tumble dryer must be aligned and set up on a level surface. Adjust the tumble dryer adjustable feet until the machine is level. After the machine has been aligned, screw the nuts tightly to the base plate using a screwdriver.

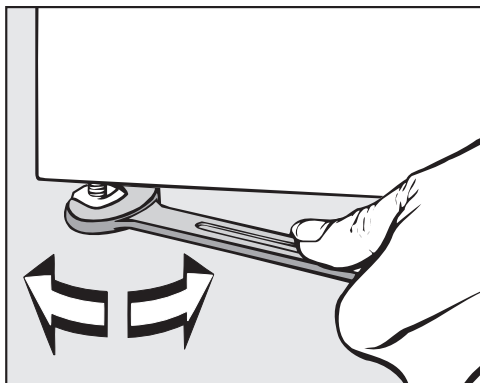

Tip: Use a spirit level to ensure correct alignment.

- Gas-heated tumble dryers or tumble dryers that are installed on a plinth or offshore must be fastened to the floor with tensioning strips following installation.

⚠ Danger of gas leakage from gas-heated tumble dryers due to lack of floor fastening. Accidental displacement of a gas-heated tumble dryer can damage the gas line and cause gas to leak.
After installation, always secure gas-heated tumble dryers to the floor using suitable fastening material.

Electrical connection

The electrical connection must be established by a qualified electrician.

- ▶ The electrical connection may only be made to an electrical system provided in accordance with all appropriate local and national legislation, regulations and guidelines. Please also observe the regulations set out by your insurance provider and energy supplier, accident prevention regulations, as well as recognised codes of practice.
- ▶ Reliable and safe operation of this tumble dryer is only ensured if it has been connected to the mains electricity supply.

The required supply voltage, power rating and fuse rating can be found on the data plate on the tumble dryer. Ensure that the supply voltage matches the voltage quoted on the data plate before establishing the electrical connection to the tumble dryer.

Connection to a supply voltage other than the one quoted on the data plate can damage the tumble dryer if the voltage is too high.

- ▶ If more than one voltage is specified on the data plate, the tumble dryer can be converted for connection to the relevant input voltage. This conversion must be performed by the Miele Customer Service Department or by an authorised dealer. During the conversion, the wiring instructions given on the wiring diagram must be followed.

Tip: We recommend connecting the tumble dryer to the power supply via a plug and socket so that it is easier to conduct electrical safety checks (e.g. during maintenance or repair work).

It is recommended the tumble dryer is connected with a suitable plug and socket in accordance with IEC 60309-1, however if the installation requires a hard-wired connection, an all-pole means of isolation must be provided on site. Switches with a minimum contact gap greater than 3 mm are suitable disconnectors. These include circuit breakers (MCB), fuses and contactors (VDE 0660) (IEC/EN 60947)

Installation

If the mains supply cannot be permanently disconnected, the isolation device (including plug and socket) must be safeguarded against being switched on either unintentionally or without authorisation.

► The tumble dryer must not be connected to devices such as timers which would switch it off automatically.

► If it is necessary to install a residual current device (RCD) in accordance with local regulations, a residual current device type B (sensitive to universal current) must be used.

⚠ Loud noises and risk of damage due to incorrect phase connection on heat-pump dryers.

An incorrect phase position causes a lot of noise in tumble dryers with heat pumps and can cause damage to the compressor.

When connecting a heat-pump dryer to the power connection, ensure the correct phase position according to the wiring diagram.

Installation of electrically heated and gas-heated variants

Air intake/exhaust air

The tumble dryer may only be operated when the ducting has been connected properly and the room is sufficiently ventilated.

Silencer (Miele accessory available to order)

The use of silencers is not permitted in exhaust ducting used by gas-heated washing machines or ironers. The tightness of the silencer is classified as category B in accordance with EN 13180.

With gas-heated tumble dryers, Building regulations approval must be obtained for the overall ducting system. You are not permitted to install multiple tumble dryers to a single silencer. If the tumble dryer is connected to a shared extraction system, the silencer must be installed directly onto the tumble dryer's exhaust connection point. The non-return flap must then be installed downstream of the silencer in the direction of flow.

Calculating the total length and diameter of a supply-air or exhaust pipe

The length of the required pipeline and the number and shape of the elbows are determined by the structural conditions. In order to avoid impairing the airflow performance, the pipeline should be as short as possible and if feasible should not have any sharp bends.

In addition, a decision must be made as to whether flexible piping or steel piping should be installed with a round or square cross-section. If the tumble dryer is connected to a central air supply, the total pipe length is calculated from the sum of all exhaust and supply pipes. The maximum supply pipe length should not exceed half of the total pipe length.

⚠ The exhaust ducting for gas-heated appliances must not be made from flammable materials.

Otherwise there is a risk of fire.

Use only non-flammable materials for the exhaust ducting.

In upward exhaust ducting systems, a condensate drain must be fitted at the lowest point. The condensate must be drained via a water collection tray or a floor drain positioned in an appropriate location.

If air is being directed from multiple appliances into a combined ducting system (exceptional circumstances), a non-return device (non-return flap) must be installed in the ducting for each appliance to prevent backflow.

To make subsequent cleaning of the pipes easier, inspection hatches should be fitted to elbows wherever possible.

The on-site exhaust ducting and outlet to the outdoors must be regularly checked for lint deposits and cleaned if necessary.

Installation

Substitute pipe lengths

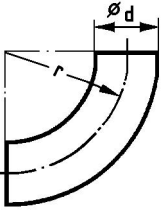
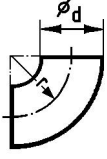
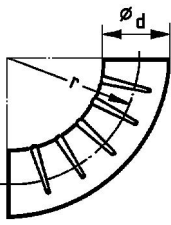
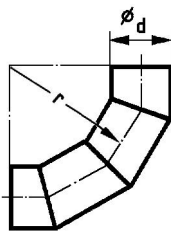
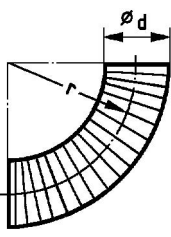
Type of elbow	Type		PDR 516 SL
	90° elbow	$r = 2d$	1.1 m
	45° elbow	$r = 2d$	0.7 m
	90° elbow	$r = d$	1.9 m
	45° elbow	$r = d$	1.1 m
	90° corrugated pipe elbow	$r = 2d$	3.2 m
	45° corrugated pipe elbow	$r = 2d$	2.0 m
	90° segmented elbow (3 welded seams)	$r = 2d$	1.2 m
	90° elbow, Westaflex ducting	$r = 2d$ $r = 4d$	1.2 m 0.9 m
	45° elbow, Westaflex ducting	$r = 2d$ $r = 4d$	1.0 m 0.8 m
	Non-return flap		5.5 m

Maximum permissible total ducting length

Clear minimum pipe diameter (metal pipes)	PDR 516
150 mm	10 m
180 mm	27 m
200 mm	48 m
Permissible counter pressure in the vent ducting EL: electrically heated G: gas heated	EL: 350 Pa G: 300 Pa

When connecting the vent ducting to the exhaust duct on a machine, particular care must be taken to make sure the connection is secure and air-tight.

With complex ducting with many bends and additional components, or when several different appliances are connected to a shared duct, it is recommended that a detailed pipework calculation is carried out by a qualified specialist.

The vent ducting must not be channeled into a chimney or flue already in use for any gas, coal or oil-burning installation. The warm and moist exhaust air is to be conducted to the outside or through suitable ventilation ducting along the shortest path possible. The vent ducting must be laid so that air flow is not hindered. To achieve this, use as few bends as possible along with short pipelines and well-made connections and transitions checked for air-tightness. No filters or grilles may be fitted in the vent ducting.

The end of the vent ducting leading outside must be protected against the elements, e.g. with a downward-facing 90° elbow.

 During tumble dryer operation, the room must be adequately ventilated.

Room ventilation opening for air intake from the setup room

The minimum dimension of the ventilation opening depends on the cross-section of the extraction ducting.

If the tumble dryer is connected to a central air supply, additional ventilation openings are normally not needed. Additional ventilation for comfort air/cooling of the room may be required depending on the installation.

Extraction ducting			Minimum dimension for ventilation opening		
⊙	□	A	A	⊙	□
150 mm	-	177 cm ²	531 cm ²	260 mm	230 mm
-	150 mm	225 cm ²	675 cm ²	295 mm	260 mm
180 mm	-	254 cm ²	762 cm ²	315 mm	280 mm
-	180 mm	324 cm ²	972 cm ²	355 mm	315 mm
200 mm	-	314 cm ²	942 cm ²	350 mm	310 mm
-	200 mm	400 cm ²	1200 cm ²	395 mm	350 mm
220 mm	-	380 cm ²	1140 cm ²	381 mm	377 mm
-	220 mm	484 cm ²	1452 cm ²	430 mm	382 mm
250 mm	-	491 cm ²	1473 cm ²	435 mm	385 mm
-	250 mm	625 cm ²	1875 cm ²	490 mm	435 mm
300 mm	-	707 cm ²	2121 cm ²	520 mm	460 mm
-	300 mm	900 cm ²	2700 cm ²	590 mm	520 mm

Gas connection (only for gas-heated variants)

The gas connection may only be carried out by a registered installation technician in accordance with the applicable national regulations.

The use of a gas socket for the supply hose is not permitted as the flow rate is too low for the specified heater rating.

The gas heating is configured at the factory in line with the gas specifications on the sticker on the rear of the appliance.

If the gas type needs to be changed, please request the appropriate conversion kit from the Miele Customer Service Department. Information is required on the appliance type, serial number, gas family, gas group, gas connection pressure and country of installation. This gas conversion may only be carried out by a registered specialist.

Installation

Gas safety precautions

This machine must be installed in accordance with local and national building and safety regulations by a suitably qualified engineer. In the U.K. this must be done for gas-heated machines by a Gas Safe registered engineer. Adequate ventilation must be present in the room in which the machine is operated. It is essential to read these instructions before installing and operating the machine.

In the UK:

- Gas Emergency Contact Centre (Tel: 0 800 111 999)
- For any gas work in the UK always use a Gas Safe registered engineer.



In other countries please follow relevant country specific procedures on gas.

Keep these instructions in a safe place and ensure they are made available to new users. They must be made aware of these Warning and Safety instructions.

All personnel working with this machine must be fully trained in all aspects of its use and safety.

Take these safety precautions if you smell gas

- Extinguish all flames immediately.
- Close the on-site gas shut-off device, the gas shut-off device on the gas meter or the main gas shut-off device immediately.
- Open all windows and doors immediately.
- Do not light any naked flames (e.g. matches or lighters).
- Do not smoke.
- If there is the smell of gas in a room, never enter the room with a naked flame.
- Do not carry out any actions that will create electrical sparks (such as pulling out electrical plugs or pressing electrical switches or bells).
- If you cannot find the cause of the gas smell and all gas valves have been shut off, please call the gas supply company immediately.

If other persons are being shown how to operate the appliance, they must be given and/or made aware of these important safety precautions.

During installation, the technical regulations for gas installations as well as national and regional building regulations, fire regulations and specifications from the relevant gas supply companies must be adhered to.

When planning a gas-heated system, contact the relevant gas supply company and a building regulations inspector.

Installation site

Gas-heated tumble dryers must **not** be operated in a room where cleaning machines operate with solvents containing perchloroethylene or CFCs. During combustion, any vapours that are emitted will break down into hydrochloric acid, leading to consequential damage affecting laundry and the appliance. Air exchange must not take place if appliances are set up in separate rooms.

Rooms with fuel-burning installations must be adequately aerated and ventilated. Any gas-heated appliance must be considered to be a fuel-burning installation (regardless of its gas flow rate).

If no low pressure occurs when a full fire is burning in all fuel-burning installations, this means that the room ventilation is working properly, even if the exhaust gases from the installations are being extracted mechanically. This ensures that the gas is being combusted correctly and that the exhaust gases are being evacuated completely.

It must not be possible to seal off aeration and ventilation openings.

⚠ Before completing commissioning, maintenance, conversion and repair work, all gas-conducting components – from the manual shut-off valve to the burner jet – must be checked for leaks.

Particular attention must be paid to the measuring stubs on the gas valve. Checks must be performed when the burner is both switched on and switched off.

- ▶ Installing thermal shut-off equipment on site is recommended.
- ▶ If gas-heated appliances are accessible to anyone, it is also necessary to check whether a gas flow monitor needs to be used.

Gas supply

Required flow rate

Machine type	Rated heat load (Hi)	Natural gas (LL)	Natural gas (E)	Liquid gas
PDR 516	18 kW	2.22 m ³ /h	1.90 m ³ /h	1.42 kg/h

The rated load is based on the following calorific values:

Natural gas LL (G 25): 29.25 MJ/m³ (Hi)

Natural gas E (G 20): 34.02 MJ/m³ (Hi)

Liquid gas (G 30): 45.65 MJ/m³ (Hi)

Natural gas

Internal diameter	Length of gas line (natural gas)						
	3 m	5 m	10 m	20 m	30 m	50 m	100 m
	Maximum flow rate						
¾" (20 mm)	4.7 m ³ /h	3.7 m ³ /h	2.6 m ³ /h	1.6 m ³ /h	1.1 m ³ /h	0.7 m ³ /h	0.3 m ³ /h
1" (25 mm)	8.6 m ³ /h	6.9 m ³ /h	4.8 m ³ /h	3.1 m ³ /h	2.4 m ³ /h	1.9 m ³ /h	0.9 m ³ /h
1¼" (32 mm)	16.0 m ³ /h	12.4 m ³ /h	8.7 m ³ /h	6.2 m ³ /h	5.0 m ³ /h	3.8 m ³ /h	2.4 m ³ /h
1½" (40 mm)	26.5 m ³ /h	20.5 m ³ /h	14.5 m ³ /h	10.3 m ³ /h	8.4 m ³ /h	6.5 m ³ /h	4.0 m ³ /h
2" (50 mm)	60.0 m ³ /h	47.0 m ³ /h	33.0 m ³ /h	23.0 m ³ /h	19.0 m ³ /h	15.0 m ³ /h	10.0 m ³ /h

Installation

Liquid gas

	Length of gas line (liquid gas)			
	5 m	10 m	20 m	50 m
Internal diameter	Maximum flow rate			
10 mm	1.3 kg/h	1.0 kg/h	-	-
12 mm	2.0 kg/h	1.5 kg/h	1.0 kg/h	-
16 mm	4.0 kg/h	3.0 kg/h	2.0 kg/h	1.5 kg/h
22 mm	9.0 kg/h	6.5 kg/h	4.5 kg/h	3.0 kg/h
27 mm	-	12.0 kg/h	8.0 kg/h	5.0 kg/h

Exhaust gas evacuation ducts

Gas-heated Miele tumble dryers are type B₂₂ gas fuel-burning installations without flow safeguarding equipment, and with a fan behind the heater.

- The mixtures of exhaust gas and air that are emitted by gas-heated tumble dryers must be evacuated through a suitable chimney and out into the atmosphere via the roof.
- Vent ducts for exhaust air and exhaust gas must be kept as short as possible. The ducts must rise vertically up to the flue.
- Only materials that are resistant to heat and sooting may be used.
- A condensate drain must be placed at the lowest point of the vent ducting. The condensate must be drained via a water collection tray or a floor drain positioned in an appropriate location. No filters or grilles may be fitted in the pipeline. The vent ducting for exhaust air and exhaust gas must be installed leak-tight.

The latest guidelines for approving exhaust gas systems containing low-temperature exhaust gases must be observed.

Exceptions

1. Where it is not possible for evacuation to take place through a single duct, appropriate measures must be put in place to ensure that the exhaust gas/air mixture from the machine is not able to enter the room in which the appliance is located via the exhaust duct for other appliances (e.g. through the use of baffles and merged lines with a shape that is favourable for the flow). When using a shape that is favourable for the flow, it is important to ensure that high pressure cannot arise at the side that is not being operated. Machines fitted with fans must not be connected to the same vent flue as those without fans.
2. When evacuating the exhaust gas/air mixture through the exterior wall, no dangers or unreasonable nuisance may arise.
3. With a combined line, the exhaust air vent ducts for the individual machines must be installed horizontally in the combined line, in a way that is favourable for the flow. The cross-section of the vent flue must not be smaller than the cross-section of the combined line. Combined lines must be kept as short as possible and must rise vertically up to the vent flue. A condensate drain is required at the lowest point.

All exceptional cases, and particularly those where a combined line is being installed, require special permission from the relevant building regulations inspector supervisor's office.

Diameter and cross-section of the vent ducting

Tumble dryer	Exhaust gas connection Diameter/cross-section
PDR 5xx SL	150 mm/176 cm ²

Connection and conversion instructions

Connection and conversion work must be performed by the Miele Customer Service Department or by an authorised dealer.

The settings for tumble dryers are made at the factory in line with the gas specifications at the rear of the appliance.

Gas hose

The gas machine must be connected using a corrugated metal hose assembly made from stainless steel in accordance with DIN 3384 and BS 669-2. Alternatively, a hose that complies with DIN EN 16617 may be used with connections in accordance with DIN 3384.

The maximum length of the hose is 2 m. When selecting a hose, the required flow rate and applicable national regulations must also be taken into account.

Main connection

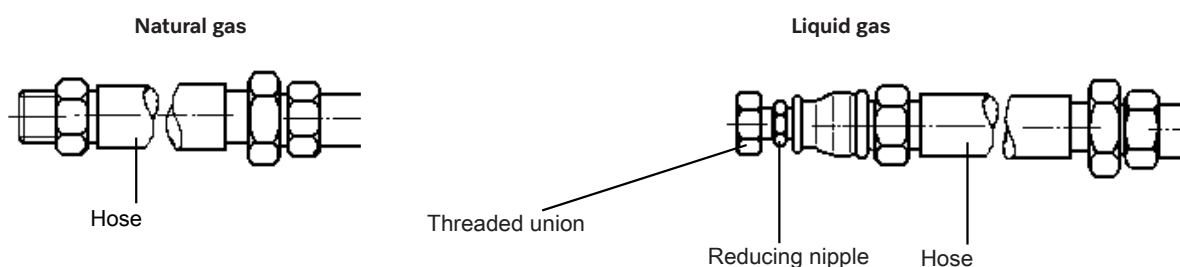

Gas regulator valve

Remove the plastic cap at the top to adjust the jet pressure. Under the plastic cap there is a screw in a hexagon. To adjust the jet pressure, this screw must be adjusted with a flat-head screwdriver.

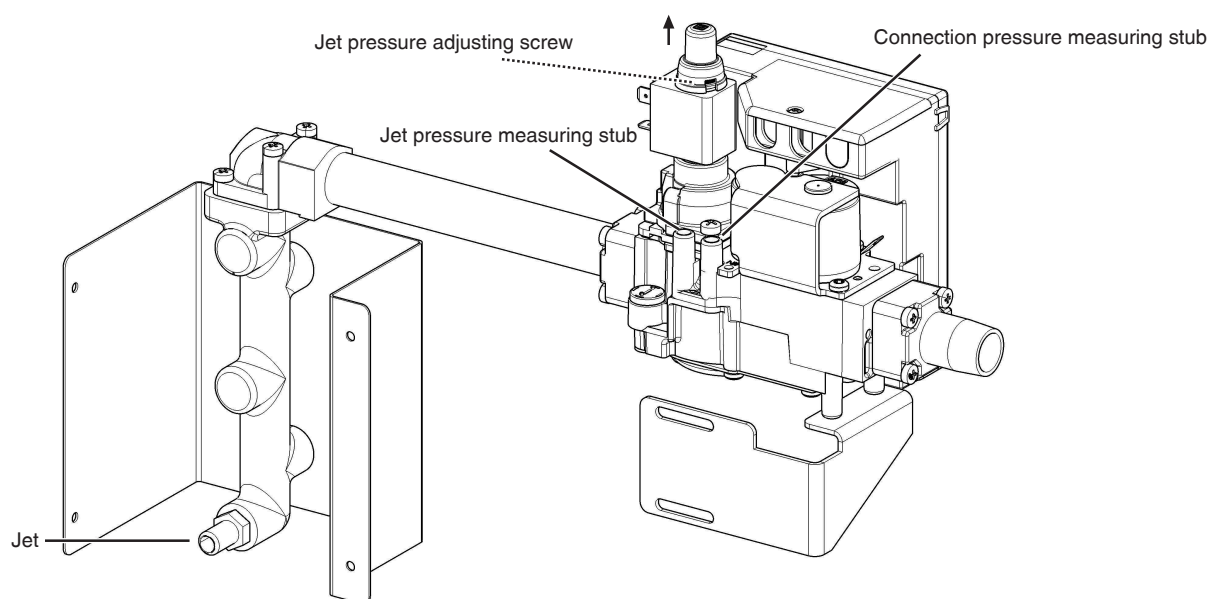

Installation

Gas settings

Model	Heater rating	Nozzle diameter	Nozzle pressure in mbar					
			2E/2H (AT, BE, CH, CY, CZ, DE, DK, EE, ES, FI, FR, GB, GR, HR, IE, IT, IS, LT, LV, NL, NO, PL, PT, RO, SE, SI, SK, TR)	2LL/2L (DE, NL)	2K** (NL)	3B/P (AT, CH, CY, CZ, DE, DK, EE, FI, GR, HR, IT, LT, LV, NL, NO, RO, SE, SI, SK, TR)	3P (BE, CH, ES, FR, GB, IE, IS, PL, PT)	1e* (DK)
Natural gas PDR 516	18 kW	4.0 mm	8.0	12.5	12.5	-	-	-
Liquid gas PDR 516	18 kW	2.6 mm	-	-	-	14.4	18.6	-
Town gas* PDR 516	18 kW	6.9 mm	-	-	-	-	-	5.0

* Denmark only

** Netherlands only

Gas connection pressures

With natural gas, if the connection pressure is less than 17 mbar (due to pressure loss in the supply network, for example), the gas supply company must be informed.

Country	Gas category	Connection pressure for natural gas (mbar)			Connection pressure for liquid gas (mbar)			Connection pressure for town gas* (mbar)		
		n _p	min _p	max _p	n _p	min _p	max _p	n _p	min _p	max _p
AT	II ₂ H3B/P	20	17	25	50	42.5	57.5	-	-	-
BE	I ₂ E(R)B	20	17	25	-	-	-	-	-	-
		25	20	30	-	-	-	-	-	-
	I ₃ P	-	-	-	37	25	45	-	-	-
BG	II ₂ H3B/P	20	17	25	29	25	35	-	-	-
CH	II ₂ H3B/P	20	17	25	50	42.5	57.5	-	-	-
CY	II ₂ H3B/P	20	17	25	29	25	35	-	-	-
CZ	II ₂ H3B/P	20	17	25	29	25	35	-	-	-
DE	II ₂ ELL3B/P	20 (E)	17 (E)	25 (E)	50	42.5	57.5	-	-	-
		20 (LL)	18 (LL)	25 (LL)						
DK	III _{1e2} H3B/P	20	17	25	29	25	35	8	6	15
EE	II ₂ H3B/P	20	17	25	29	25	35	-	-	-
ES	II ₂ H3P	20	17	25	37	25	45	-	-	-
FI	II ₂ H3B/P	20	17	25	29	25	35	-	-	-
FR	I ₂ Er	20	17	25	-	-	-	-	-	-
		25	20	30	-	-	-	-	-	-
	I ₃ P	-	-	-	37	25	45	-	-	-
GB	II ₂ H3P	20	17	25	37	25	45	-	-	-
GR	II ₂ H3B/P	20	17	25	29	25	35	-	-	-
HR	II ₂ H3B/P	20	17	25	29	25	35	-	-	-
HU	II ₂ H3B/P	25	20	30	50	42.5	57.5	-	-	-
IE	II ₂ H3P	20	17	25	37	25	45	-	-	-
IS	II ₂ H3P	20	17	25	30	25	35	-	-	-
IT	II ₂ H3B/P	20	17	25	29	25	35	-	-	-
LT	II ₂ H3B/P	20	17	25	29	25	35	-	-	-
LU	II ₂ E3B/P	20	17	25	29	25	35	-	-	-

Installation

Country	Gas category	Connection pressure for natural gas (mbar)			Connection pressure for liquid gas (mbar)			Connection pressure for town gas* (mbar)		
		n p	min p	max p	n p	min p	max p	n p	min p	max p
LV	I ² H3B/P	20	17	25	29	25	35	-	-	-
MT	I ³ B/P	-	-	-	29	25	35	-	-	-
NL	I ² EK3B/P	20 (E)	17 (E)	25 (E)	29	25	35	-	-	-
		25 (K)	20 (K)	30 (K)						
	I ² L3B/P	25	20	30	29	25	35	-	-	-
NO	I ² H3B/P	20	17	25	29	25	35	-	-	-
PL	I ² E3P	20	17	25	37	25	45	-	-	-
PT	I ² H3P	20	17	25	37	25	45	-	-	-
RO	I ² H3B/P	20	17	25	29	25	35	-	-	-
SE	I ² H3B/P	20	17	25	29	25	35	-	-	-
SI	I ² H3B/P	20	17	25	29	25	35	-	-	-
SK	I ² H3B/P	20	17	25	29	25	35	-	-	-
TR	I ² H3B/P	20	17	25	29	25	35	-	-	-

* Denmark only

Installation of variants with heat pumps

General operating conditions

This heat-pump dryer is intended only for use in a commercial environment and must only be operated indoors.

Ambient temperature for optimum heat-pump operation:
+10 °C to +40 °C

The ambient temperature for the heat-pump dryer must be at least 10 °C.
At lower ambient temperatures, there is a risk of ice forming on the lower heat exchanger.
This can also result in unexpected condensate formation.

Depending on the nature of the installation site, sound emissions and vibrations may occur.

Tip: Have the installation site inspected and seek the advice of a professional in instances where increased noise may cause a nuisance.

Transport

The tumble dryer and the heat pump must not be transported without transport pallets.
Suitable transport aids must always be used during transportation.
Tilting the heat pump by more than 30° should be avoided if at all possible.

After the heat pump has been transported, it should be left to stand for approximately one hour before commissioning. If the heat pump is subjected to especially strong vibrations or is tilted by more than 30°, it should be left to stand for up to 24 hours.

At the next installation site, the tumble dryer and the heat pump must be lifted off the transport pallet using suitable lifting gear.

If the heat-pump unit is tilted **up to a maximum of 30°** during transportation, it must be left to stand for at least one hour after it has been installed before the heat-pump dryer can be operated.

If the heat-pump unit was tilted by an angle **exceeding 30°** or if it was subjected to strong vibrations, the machine must be left to stand for 24 hours before commissioning.

After transportation and installation, downtime of at least one hour is required before connecting the tumble dryer to the electricity supply.
Insufficient downtime before commissioning can damage the heat pump.

Air intake vent

Air intake for the condenser is via an air intake vent at the front of the dryer. Air is taken from the room in which the dryer is installed.

A fluff filter is located in the air intake vent in the dryer. This must be regularly cleaned by hand.

The air intake vent must be kept clear. It must not be covered.

Air outlet vent

Because the heat-pump dryer operates with a closed air circuit, separate exhaust ducting is not required.

Installation

The warm air expelled from the machine as a result of cooling down the heat-exchanger warms the room air. It is essential to ensure the room has adequate ventilation, e.g. by providing ventilation openings that cannot be closed whilst the machine is in use. Insufficient ventilation in the room increases the time required for drying, which in turn will increase the amount of energy required for the drying process.

The ventilation openings must, on no account, be closed or blocked by objects.

Condensate drainage point

The heat pump in this tumble dryer operates according to the principle of condensation. A separate, vented floor drain must be provided at the installation site for condensate produced during the drying process.

The condensate drainage point is located at the back of the heat-pump dryer. Condensate can be fed via a downwards pointing pipe to the floor drain. It must be ensured that condensate cannot flow back into the dryer.

 Risk of electric shock and injury due to using the tumble dryer without the complete casing.

If the casing is dismantled, it is possible to come into contact with live or rotating machine parts.

Once the tumble dryer has been installed, replace all the casing parts that were removed.

Pairing instructions





Follow the steps below to connect the tumble dryer to your network.

Opening the Supervisor level

- Switch on the appliance by turning the rotary control from the  position to any other position.
- Open the door of the tumble dryer.
- Press and hold the start/stop sensor control while you close the door.
- Keep pressing the start/stop sensor control until start/stop flashes and then lights up permanently.

You are now in the Supervisor level.

Establishing the local network connection via WPS

- On the supervisor level, select *PS1* using the < or > arrow buttons.
- Then select the internal communication module *-01* using the < or > arrow buttons.
- Confirm with the start/stop sensor control.
- Restart the tumble dryer by turning the rotary control to the  position.
- Switch the appliance on again by turning the rotary control from the  position to any other position.
- Press and hold the  sensor control for 4 seconds until *APP* appears on the display.
- Then press and hold the  sensor control for 2 seconds until *WPS* appears on the display.

A timer will then start.



- Press the WPS button on your router within the specified time.

The network connection via WPS is being established.

The appliance is now successfully connected.

Establishing a temporary network connection via soft AP

The network connection via soft AP is only possible if the tumble dryer is not already connected to a network.

- On the supervisor level, select *PS1* using the < or > arrow buttons.
- Then select the internal communication module *-01* using the < or > arrow buttons.
- Confirm with the start/stop sensor control.
- Restart the tumble dryer by turning the rotary control to the  position.
- Switch the appliance on again by turning the rotary control from the  position to any other position.
- Press and hold the  sensor control until *APP* appears briefly on the display.

A timer will then start. The tumble dryer now opens the soft AP for 10 minutes.

- Establish the connection with the Device Connector in Miele MOVE.

Once a connection is established, dots flash in the *A.P.P* word.

Then continue with the Device Connector in Miele MOVE.

Connectivity

Establishing the network connection using a LAN cable

The optional XKM 3200 WL PLT communication module is required for wired network connection.

- On the supervisor level, select *P91* using the < or > arrow buttons.
- Then select the COM module *-02* using the < or > arrow buttons.
- Confirm with the start/stop sensor control.
- Connect the appliance to your router/switch using the network cable. The router/switch must be connected to the Internet.

The appliance is now successfully connected.

Technical data

System requirements for WiFi

- WiFi 802.11b/g/n
- 2.4 GHz band
- WPA/WPA2 encryption
- DHCP activated
- Multicast DNS / Bonjour / IGMP snooping activated
- Ports 443, 80, 53 and 5353 open
- IP DNS server = IP standard gateway/router
- Mesh/repeater use: same SSID and password as standard gateway/router
- SSID must be permanently visible

System requirements for LAN

- DHCP activated
- Multicast DNS / Bonjour / IGMP snooping activated
- Ports 443, 80, 53 and 5353 open
- IP DNS server = IP standard gateway/router

Technical data

		PDR 51x SL
Height		1800 mm
Width		711 mm
Depth		1075 mm
Depth with door open		1760 mm
Net weight	with heat pump	193 kg
	Electrically heated	146 kg
	Gas-heated	150 kg
Drum volume		PDR 511: 200 l
		PDR 516: 300 l
Maximum load size (dry weight)		PDR 511: 11 kg
		PDR 516: 16 kg
Supply voltage		See data plate
Fuse rating (on site)		See data plate
Power rating		See data plate
Issued test codes		See data plate
Permitted room temperature	PDR 511 (with heat pump)	10–40 °C
		2–40 °C
	PDR 516 (electrically heated)	2–40 °C
	PDR 516 (gas-heated)	
Max. floor load in operation	with heat pump	2052 N
	Electrically heated	1664 N
	Gas-heated	1704 N
Product safety standard		EN/IEC 60335-1; EN 50570; IEC 60335-2-11
Sound pressure level, EN ISO 11204		< 70 dB (A)
Sound power level, EN ISO 9614-2		< 80 dB (A)
Frequency range		2.4000–2.4835 GHz
Maximum transmission power		< 100 mW

UK declaration of conformity

UKCA mark (UK only)

The Supply of Machinery (Safety) Regulations 2008

This **Statement of Compliance** confirms this Miele product fully complies with the **Product Security and Telecommunications Infrastructure (Security Requirements for Relevant Connectable Products) Regulations 2023**.

- 1) Professional Appliance – *Tumble Dryer, commercial PT011, PT012, PT016, PT018*
- 2) Manufactured by: Miele & Cie KG, *PT013, PT014, PT015, PT017*
 Carl Miele Street 29, 33332 Gutersloh Germany
 Imported by and contact point: Miele Company Ltd, Fairacres, Marcham Road, Abingdon, Oxon, OX14 ITW Great Britain
- 3) The defined support period at the time of first supply is 10 years
- 4) To report vulnerabilities and cybersecurity issues please contact: psirt@miele.com
- 5) Signature 
 Name: **Paul Wright**
 Company Position: **Head of Technical Management**
 Date of signature: **19th March 2024**
 Place of signature: **Abingdon, Oxfordshire**

United Kingdom

Miele Co. Ltd., Fairacres, Marcham Road
Abingdon, Oxon, OX14 1TW
Professional Sales, Tel: 0845 365 6608
E-mail: professional@miele.co.uk
Internet: www.miele.co.uk/professional

Australia

Miele Australia Pty. Ltd.
ACN 005 635 398, ABN 96 005 635 398
Level 4, 141 Camberwell Road, Hawthorn East, VIC 3123
Tel: 1300 731 411
Internet: www.miele.com.au/professional
E-mail: professional.sales@miele.com.au

China Mainland

Miele Electrical Appliances Co., Ltd.
1-3 Floor, No. 82 Shi Men Yi Road
Jing' an District, 200040 Shanghai, PRC
Tel: +86 21 6157 3500, Fax: +86 21 6157 3511
E-mail: info@miele.cn, Internet: www.miele.cn

Hong Kong, China

Miele (Hong Kong) Ltd.
41/F - 4101, Manhattan Place
23 Wang Tai Road, Kowloon Bay, Hong Kong
Tel: (852) 2610 1025, Fax: (852) 3579 1404
Email: customerservices@miele.com.hk
Website: www.miele.hk

India

Miele India Pvt. Ltd.
1st Floor, Copia Corporate Suites,
Commercial Plot 9, Mathura Road, Jasola,
New Delhi - 110025
E-mail: customercare@miele.in, Website: www.miele.in

Ireland

Miele Ireland Ltd.
2024 Bianconi Ave., Citywest Business Campus,
Dublin 24
Tel: (01) 461 07 10, Fax: (01) 461 07 97
E-Mail: info@miele.ie, Internet: www.miele.ie

Malaysia

Miele Sdn Bhd
Suite 12-2, Level 12
Menara Sapura Kencana Petroleum
Solaris Dutamas No. 1, Jalan Dutamas 1
50480 Kuala Lumpur, Malaysia
Phone: +603-6209-0288
Fax: +603-6205-3768

New Zealand

Miele New Zealand Limited
IRD 98 463 631
8 College Hill
Freemans Bay, Auckland 1011, NZ
Tel: 0800 464 353
Internet: www.miele.com.au/professional
E-mail: professional.sales@miele.com.au

Singapore

Miele Pte. Ltd.
29 Media Circle, #11-04 ALICE@Mediapolis
Singapore 138565
Tel: +65 6735 1191, Fax: +65 6735 1161
E-Mail: info@miele.com.sg
Internet: www.miele.sg

South Africa

Miele (Pty) Ltd
63 Peter Place, Bryanston 2194
P.O. Box 69434, Bryanston 2021
Tel: (011) 875 9000, Fax: (011) 875 9035
E-mail: info@miele.co.za
Internet: www.miele.co.za

United Arab Emirates

Miele Appliances Ltd.
Showroom 1, Eiffel 1 Building
Sheikh Zayed Road, Umm Al Sheif
P.O. Box 114782 - Dubai
Tel. +971 4 3044 999, Fax. +971 4 3418 852
800-MIELE (64353)
E-Mail: info@miele.ae
Website: www.miele.ae



Manufacturer: Miele & Cie. KG, Carl-Miele-Straße 29, 33332 Gütersloh, Germany