

## Operating instructions Washer-dryer



To avoid the risk of accidents or damage to the machine, it is **essential** to read these instructions before it is installed and used for the first time.

# Contents



---

<b>Caring for the environment</b> .....	<b>5</b>
<b>Warning and Safety instructions</b> .....	<b>6</b>
<b>Operating the washer-dryer</b> .....	<b>14</b>
Control panel.....	14
How the control field works.....	15
Applications.....	15
<b>Before using for the first time</b> .....	<b>16</b>
Miele@home .....	17
Setting up Miele@home .....	18
Running the first wash programme .....	18
<b>Environmentally friendly washing and drying</b> .....	<b>20</b>
<b>WASHING</b> .....	<b>21</b>
1. Prepare the laundry .....	21
General tips .....	21
2. Loading the washer-dryer.....	22
3. Selecting a programme .....	23
4. Adding detergent .....	25
5. Starting the programme.....	28
6. End of the programme/unloading laundry.....	28
Spin speeds.....	29
Programme chart.....	30
Programme sequence.....	32
Detergent.....	33
Water softeners .....	33
Fabric conditioners, liquid starch, starch .....	34
<b>DRYING</b> .....	<b>37</b>
1. Prepare the laundry .....	37
2. Loading the washer-dryer.....	38
3. Selecting a programme .....	38
4. Select programme settings .....	39
5. Starting the programme.....	40
6. End of the programme/unloading laundry.....	40
Programme chart.....	41
Thermospin.....	43
<b>WASHING AND DRYING</b> .....	<b>44</b>
1. Prepare the laundry .....	44
2. Loading the washer-dryer.....	44
3. Selecting a programme .....	44
4. Selecting programme settings.....	44
5. Add detergent.....	45

6. Programme start/finish .....	45
After each washing or drying programme .....	45
<b>Rinse out fluff programme .....</b>	<b>46</b>
<b>Changing the programme sequence .....</b>	<b>47</b>
Changing a programme (safety lock) .....	47
Cancelling a programme .....	47
Adding laundry - AddLoad .....	47
<b>Delay start/SmartStart .....</b>	<b>48</b>
Delay start .....	48
<b>Cleaning and care .....</b>	<b>50</b>
Cleaning the casing and control panel .....	50
Cleaning the detergent dispenser drawer .....	50
Cleaning the drum .....	52
Cleaning the water intake filter .....	52
<b>Problem solving guide .....</b>	<b>53</b>
A programme does not start .....	53
Programme cancellation and fault indicator light .....	54
Fault indicator light lights up at the end of a programme .....	55
Symbols on the time display .....	56
General problems with the washer-dryer .....	57
An unsatisfactory wash result .....	60
Unsatisfactory drying results .....	61
The door will not open .....	62
Opening the door in the event of a blocked drain outlet and/or power cut .....	63
<b>Service .....</b>	<b>65</b>
Contact in the event of a fault .....	65
Warranty .....	65
Optional accessories .....	65
EPREL database .....	65
<b>Installation .....</b>	<b>66</b>
Front view .....	66
Rear view .....	67
Installation surface .....	68
Carrying the washer-dryer to its installation site .....	68
Removing the transit bars .....	68
Refitting the transit bars .....	70
Installing under a worktop .....	70
Aligning the washer-dryer .....	71
The water protection system .....	72
Water intake .....	72

# Contents

---

Water drainage.....	74
Electrical connection .....	75
<b>Garment care label symbols.....</b>	<b>76</b>
<b>Technical data.....</b>	<b>77</b>
EU Conformity declaration.....	78
UK Conformity declaration .....	78
<b>Consumption data .....</b>	<b>79</b>
<b>Programmable functions .....</b>	<b>80</b>
Choosing and selecting a programmable function.....	80
Editing and saving a programmable function .....	81
Exiting the programming level .....	81
<i>P11</i> Buzzer duration.....	81
<i>P12</i> Buzzer .....	81
<i>P13</i> Keypad tone .....	82
<i>P14</i> PIN code .....	82
<i>P22</i> Control field switch-off behaviour.....	82
<i>P24</i> Memory.....	83
<i>P28</i> Gentle action.....	83
<i>P29</i> Temperature reduction.....	83
<i>P32</i> Maximum rinse level.....	83
<i>P33</i> Suds cooling.....	83
<i>P49</i> Low water pressure .....	84
<i>P62</i> Display brightness .....	84
<i>P70</i> Cottons drying levels.....	84
<i>P71</i> Minimum iron drying levels.....	84
<i>P72</i> Extended cool down.....	84
<i>P77</i> Laundry ring prevention.....	84
<i>P90</i> Operating hours .....	85
<i>P97</i> Remote control.....	85
<i>P98</i> SmartGrid.....	85
<i>P99</i> RemoteUpdate.....	86
<i>P00</i> Factory default .....	87
Switching off WiFi .....	87
Copyrights and licences for the communication module.....	87
<b>Detergents and care products .....</b>	<b>88</b>
Detergent.....	88
Specialist detergents  .....	89
Fabric care  .....	90
Additives  .....	90
Machine care .....	90

### Disposing of the packaging material

The packaging material is used for handling and protects the appliance from transport damage. The packaging material used is selected from materials which are environmentally friendly for disposal and can generally be recycled.

Recycling the packaging material reduces the use of raw materials. Use material-specific collection points for valuable materials and take advantage of return options. Your Miele dealer will take the packaging material away.

### Disposing of your old appliance

Electrical and electronic appliances contain many valuable materials. They also contain certain materials, compounds and components which were essential for their correct functioning and safety. These could be hazardous to human health and to the environment if disposed of with household waste or if handled incorrectly. Please do not, therefore, dispose of your old appliance with household waste.



Instead, please make use of officially designated collection and disposal points to dispose of and recycle electrical and electronic appliances in your local community, with your dealer or with Miele, free of charge. By law, you are solely responsible for deleting any personal data from the old appliance prior to disposal. You are legally obliged to remove any old batteries which are not securely enclosed by the appliance and to remove any lamps without destroying them, where this is possible. These must be taken to a suitable collection point where they can be handed in free of charge. Please ensure that your old appliance poses no risk to children while being stored for disposal.

# Warning and Safety instructions

---

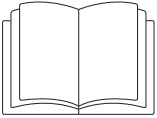

- ▶ It is **essential** to read these instructions.

This washer-dryer complies with all current local and national safety requirements. However, inappropriate use can lead to personal injury and damage to property.

Read the operating instructions carefully before using the washer-dryer. They contain important information on safety, installation, use and maintenance. This prevents both personal injury and damage to the washer-dryer.

In accordance with standard IEC 60335-1, Miele expressly and strongly advises that you read and follow the instructions in the chapter on installing the washer-dryer as well as the safety instructions and warnings.

Miele cannot be held liable for damage caused by non-compliance with these instructions.

Keep these operating instructions in a safe place and pass them on to any future owner.

## Correct application

- ▶ This washer-dryer is intended for use in domestic households and similar working and residential environments.

- ▶ This washer-dryer is intended for use in domestic households for the following applications only:

- washing textiles which have a care label stating that they are washable.
- drying textiles which have been washed in water and have a care label stating that they are suitable for tumble drying.

Any other usage is not permitted. Miele cannot be held liable for damage resulting from improper use or incorrect operation of the machine.

- ▶ This washer-dryer is not intended for outdoor use.

## Warning and Safety instructions

---

▶ This washer-dryer can only be used by people with reduced physical, sensory or mental capabilities, or lack of experience or knowledge, if they are supervised whilst using it or have been shown how to use it in a safe way and understand and recognise the consequences of incorrect operation.

### **Safety with children**

▶ Children under eight years of age must be kept away from the washer-dryer unless they are constantly supervised.

▶ Children eight years and older may only use the washer-dryer unsupervised if they have been shown how to use it safely and recognise and understand the consequences of incorrect operation.

▶ Children must not be allowed to clean or maintain the washer-dryer unsupervised.

▶ Please supervise children in the vicinity of the washer-dryer and do not let them play with it.

# Warning and Safety instructions

---

## Technical safety

▶ Before setting up the washing-dryer, check it for any externally visible damage.

Do not install or use a damaged washer-dryer.

▶ Before connecting the washer-dryer, ensure that the connection data on the data plate (fuse rating, voltage and frequency) match the mains electricity supply. If in any doubt, consult a qualified electrician.

▶ The electrical safety of this washer-dryer can only be guaranteed when correctly earthed.

It is essential that this standard safety requirement is met. If in any doubt, please have the household wiring system tested by a qualified electrician.

Miele cannot be held liable for the consequences of an inadequate earthing system (e.g. electric shock).

▶ Do not connect the machine to the mains electricity supply by an extension lead, multi-socket adapter or similar. These can overheat and are a fire hazard.

▶ Unauthorised repairs could result in unforeseen dangers for the user, for which the manufacturer cannot accept liability. Repairs should only be undertaken by a Miele authorised service technician, otherwise any subsequent damage will not be covered by the guarantee.

▶ The electrical socket must be easily accessible after installation so that the washer-dryer can be disconnected from the electricity supply if necessary.

▶ The washer-dryer must be isolated from the electricity supply when cleaning and maintaining the machine and in the event of a fault.

▶ Please observe the instructions in “Installation” and the “Technical data”.

▶ The machine must only be connected to the on-site water supply using a new hose kit. Old hose kits must not be re-used. Check the condition of the hoses regularly so that you can replace them in good time and avoid the risk of any water damage.

▶ The water inlet pressure must be at least 100 kPa and must not exceed 1000 kPa.



## Warning and Safety instructions

---

- ▶ Faulty components must only be replaced by genuine Miele original spare parts. Only when these parts are fitted can Miele guarantee the safety standards of the machine.
- ▶ If the electrical connection cable is faulty it must only be replaced by a Miele authorised service technician to protect the user from danger.
- ▶ This washer-dryer must not be used in a non-stationary location (e.g. on a ship).
- ▶ Do not make any alterations to the washer-dryer, unless authorised to do so by Miele.
- ▶ Temporary or permanent operation on an autonomous power supply system or a power supply system that is not synchronised with the mains power supply (e.g. island networks, back-up systems) is possible. A prerequisite for operation is that the power supply system complies with the specifications of EN 50160 or an equivalent standard.

The function and operation of the protective measures provided in the domestic electrical installation and in this Miele product must also be maintained in isolated operation or in operation that is not synchronised with the mains power supply, or these measures must be replaced by equivalent measures in the installation. As described, for example, in the current version of BS OHSAS 18001–2 ISO 45001.
- ▶ The manufacturer's warranty will be invalidated if the washer-dryer is not repaired by a service technician authorised by Miele.

# Warning and Safety instructions

---

## Correct use

- ▶ Do not install the washer-dryer in a room where there is a risk of frost. Frozen hoses may burst or split. The reliability of the electronic control unit may be impaired at temperatures below freezing point.
- ▶ Before using the machine for the first time, check that the transit bars at the rear of the washer-dryer have been removed (see “Installation - Removing the transit bars”). During spinning, a transit bar which is still in place may result in damage to both the washer-dryer and adjacent furniture or appliances.
- ▶ Turn off the stopcock if the washer-dryer is to be left for any length of time (e.g. holiday), especially if there is no floor drain (gully) in the immediate vicinity.
- ▶ Flooding danger. If hooking the drain hose into a wash basin, check that the water can drain off quickly enough to prevent the sink from overflowing. Make sure the drain hose is secure, so that the force of the water flowing out of the hose does not dislodge it.
- ▶ Take care to ensure that foreign objects (e.g. nails, pins, coins, paper clips) do not find their way into the machine with the laundry. These may damage components of the machine (e.g. suds container, drum), which in turn can result in damage to the laundry.
- ▶ Do not leave any detergent dispensing aids, e.g. plastic dispenser balls, in the laundry when tumble drying. These dispensers can melt during the drying programme and cause damage to the washer-dryer and the laundry.
- ▶ Risk of burning or scalding due to hot temperatures. The metal cap located on the inside of the door glass will be hot after drying. Open the door wide after drying. Do not touch the metal cap.
- ▶ Fabric conditioner and similar products must be used according to the instructions on the manufacturer's packaging.

## Warning and Safety instructions

---

- ▶ Only use dyes specified by the manufacturer as being suitable for use in a domestic washing machine. These must only be used in domestic quantities. Always observe the manufacturer's instructions carefully.
- ▶ Colour run and dye removers contain sulphur compounds which can cause corrosion. Do not use these products in this washer-dryer.
- ▶ If the correct amount of detergent is dispensed, the washer-dryer should not need to be descaled. If, however, there is large build-up of limescale and you need to descale it, you must use a special non-corrosive descaling agent. A suitable descaling agent is available to order from Miele (see “Optional accessories”). Instructions on the packaging must be strictly observed.
- ▶ To prevent the risk of fire, the following textiles **must not** be dried:
  - Items which have not been washed.
  - Items, such as workwear, which have not been thoroughly washed and which are still soiled with grease, oil or other deposits (such as cooking oil, cosmetics, lotions etc). If items have not been thoroughly washed there is a danger that these might ignite when heated, even after they have been removed from the washer-dryer at the end of the programme.
  - Items (e.g. mops and floor cloths) which have been treated with inflammable cleaning agents or which contain residues of acetone, alcohol, benzene, petrol, stain remover, turpentine, wax and wax remover or other chemicals.
  - Items which have been splashed with hair lacquer, hair spray, nail varnish remover or similar substances.

When washing heavily soiled items ensure that you use sufficient detergent and select a high temperature. If in doubt, wash the items several times.

## Warning and Safety instructions

---

▶ To prevent the risk of fire, the following textiles must not be tumble dried:

- Items which have been cleaned using chemicals (e.g. professional dry-cleaning agents).
- Items which contain a large proportion of rubber, foam rubber or rubber-like materials. For example, products made from latex foam rubber, shower caps, waterproof textiles, rubberised articles and items of clothing and pillows with foam rubber filling.
- Damaged items which contain padding or fillings (e.g. pillows, jackets). When damaged, the filling can get out with the risk of it igniting.

▶ In many programmes, the heating phase is followed by a cooling down phase to ensure that the items are not too hot to handle when you remove them (this also avoids the danger of the laundry self-igniting). The programme is not finished until the cooling down phase has been completed. As soon as the programme has finished, remove all laundry from the drum.

▶ Warning: do not switch the washer-dryer off before the drying programme has finished. If this is done, the laundry must be removed immediately and hung up or spread out to cool it down.

▶ This washer-dryer must not be connected to a controllable socket, e.g. a timer or electrical device with peak-load negotiation. There is a risk of the laundry igniting itself if a drying programme is cancelled before the cooling phase has finished.

▶ Textiles which have been pre-treated in solvent based cleaning agents must be thoroughly rinsed in clean water before being washed in the machine.

▶ Do not use solvent based cleaning agents, e.g. those containing benzene, in this washer-dryer, as this may result in damage to component parts and create toxic fumes. Such agents also pose a fire and explosion hazard.

▶ If detergent comes into contact with the eyes, rinse them thoroughly with lukewarm water immediately. If swallowed, seek medical assistance immediately and retain the packaging or label for reference. Those with skin problems or sensitive skin should avoid their skin coming into contact with detergent.

## Warning and Safety instructions

---

▶ The maximum load for this washer-dryer is 8.0 kg (dry weight) for washing and 5.0 kg (dry weight) for tumble drying. See the “Programme chart” for the maximum recommended loads for individual programmes.

### Accessories

▶ Accessory parts may only be fitted when expressly approved by Miele. If other parts are used, guarantee, performance and product liability claims will be invalidated.

▶ Miele will guarantee to supply functional spare parts for a minimum of 10 years and up to 15 years following the discontinuation of your washer-dryer.

▶ If you order a plinth for this washer-dryer (available from Miele as an optional accessory), make sure it is the correct one.

Miele cannot be held liable for damage caused by non-compliance with these Warning and Safety instructions.

# Operating the washer-dryer

## Control panel

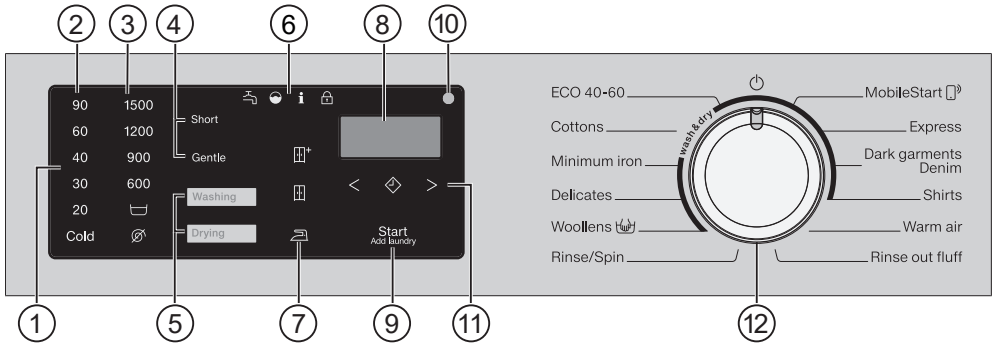

### ① Control field

The control field consists of a time display and various sensor controls. The individual sensor controls are explained in the following sections.

### ② Temperature sensor controls

for selecting the temperature

### ③ Spin speed sensor controls

for selecting the spin speed

### ④ Extra options sensor controls

You can supplement programmes with extra options. When a programme is selected, the sensor controls for the possible extra options light up.

### ⑤ Washing/drying sensor controls

You can use the *Washing* and *Drying* sensor controls to select whether you want to wash, dry or wash and dry.

### ⑥ Indicator lights



 lights up if there are faults affecting the water inlet and drainage

 lights up if excess detergent was used

**i** displays various information in combination with a number on the time display (see “Problem solving guide”)

 The *Add laundry* function cannot be selected.

### ⑦ Drying level sensor controls

Select the drying level of a drying programme using the ,  and  sensor controls.

### ⑧ Time display

After the programme has started, the programme running time will appear on the display in hours and minutes. When delay start is being used, the programme running time will appear after the delay start period has elapsed.

## ⑨ **Start/Add laundry sensor control**

- The programme can be started as soon as the sensor control is flashing on and off. Touching the *Start/Add laundry* sensor control starts the selected programme. The sensor control lights up constantly.
- Once the programme has been started, the *Start/Add laundry* sensor control allows you to add laundry.

## ⑩ **Optical interface**

This is used by the Customer Service Department as a transmission point.

## ⑪ **Delay start sensor control** with arrow buttons < and >

With the delay start function, you can delay the start of the programme. Please see “Delay start/SmartStart” for more information.

## ⑫ **Programme selector**

for selecting programmes and for switching off the appliance. The washer-dryer is switched on by selecting a programme. You can switch the washer-dryer off by turning the programme selector to the  position.

## How the control field works

The sensor controls react to fingertip contact. If a sensor control is illuminated, it can be selected.

If a sensor control is brightly lit, this means it is currently selected

If a sensor control is dimly lit, this means it can be selected

## Applications

You can use this washer-dryer to:

### - **Wash separately**

Maximum load (depending on programme) 8.0 kg

### - **Dry separately**

Maximum load (depending on programme) 5.0 kg

or

### - **Wash and dry in a continuous sequence**

Maximum load (depending on programme) 5.0 kg

## Before using for the first time

 Damage resulting from incorrect installation and connection.

Installing and connecting the washer-dryer incorrectly will cause serious property damage.

Please observe the instructions in "Installation".

This washer-dryer has undergone a complete functional test at the factory and there will be some residual water in the drum from this process.

### Removing the protective foil and stickers

#### ■ Remove:

- Any protective film from the door
- Any stickers from the front and the lid

Please do not remove any labels (e.g. the data plate) which are visible when you open the door.

### Remove the drain hose elbow from the drum

An elbow piece for the drain hose is stored in the drum.

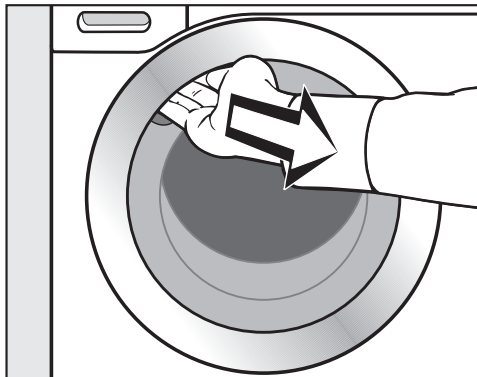

- Reach under the door grip and pull the door open.
- Remove the elbow piece.

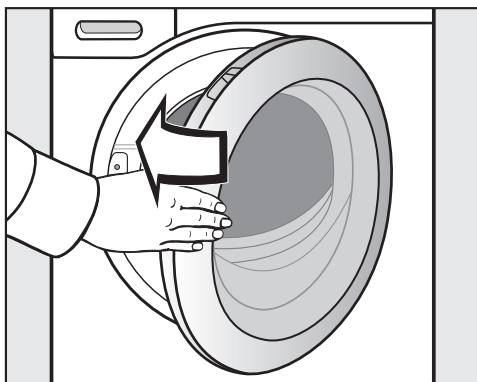

- Shut the door with a gentle swing.



# Before using for the first time

## Miele@home

Your washer-dryer is equipped with an integrated WiFi module.

To use this feature, you will need:

- A WiFi network
- The Miele app
- A Miele user account. The user account can be created via the Miele app

The Miele app will guide you as you connect your washer-dryer to your home WiFi network.

Once your washer-dryer is connected to your WiFi network, you can use the app to carry out the following activities, for example:

- Controlling your washer-dryer remotely
- Calling up information on the operating status of your washer-dryer
- Calling up information on the programme sequence of your washer-dryer

Connecting your washer-dryer to your WiFi network will increase energy consumption, even when the washer-dryer is switched off.

Make sure there is sufficient signal strength for your WiFi network at the washer-dryer installation site.

## Availability of the WiFi connection

The WiFi connection shares a frequency range with other appliances (including microwave ovens and remote control toys). This can give rise to sporadic or even complete connection failures. Therefore, the availability of featured functions cannot be guaranteed.

## Miele@home availability

The ability to use the Miele app depends on the availability of the Miele@home service in your country.

The Miele@home service is not available in every country.

For information about availability, please visit [www.miele.com](http://www.miele.com).

## Miele App

The Miele App is available to download free of charge from the Apple App Store® or from the Google Play Store™.



# Before using for the first time

## Setting up Miele@home

There are 2 ways of connecting:

1. Via the Miele app (default)
2. Via WPS

### Logging in via the Miele app

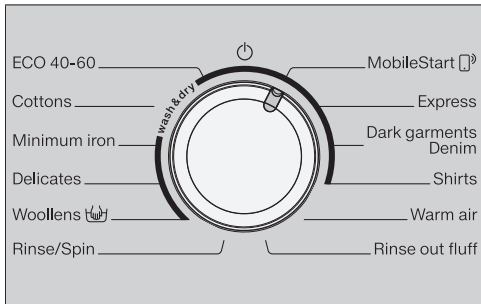

- Turn the programme selector to the *MobileStart* (📱) programme.

*APP* appears on the time display. The timeout then starts to count down from 10 minutes on the time display.

The Miele app will guide you through the remaining steps.

When you have successfully connected, *Con* will appear on the time display.

### Logging in via WPS

- Turn the programme selector to the *MobileStart* (📱) programme.
- Touch the (📶) sensor control until *WPS* appears on the time display and a short keypad tone sounds.

The timeout then starts to count down from 2 minutes on the time display.

When you have successfully connected, *Con* will appear on the time display.

**Tip:** If the connection has not been set up when the timeout has finished counting down, repeat the process.

## Running the first wash programme

⚠️ Damage resulting from failure to remove the transit bars.

Failure to remove the transit bars can result in damage to the washer-dryer and to adjacent cabinetry or appliances.

Remove the transit bars as described in "Installation".

Before first use, the *Cottons* programme must be run without laundry and without detergent.

- Open the stopcock.
- Turn the programme selector to *Cottons*.

The washer-dryer is switched on and the temperature 40 °C lights up in the control field.

- Touch the *Start/Add laundry* sensor control.



The wash programme will start.

After 10 minutes, the indicators dim, except for the *Start/Add laundry* sensor control.

### Opening the door at the end of the programme

The door remains locked during the anti-crease phase. The control field lights up for the first 10 minutes. The control field then goes out and the *Start/Add laundry* sensor control flashes.

- Turn the programme selector to the  position.

-- appears on the time display and the  indicator light goes out.

The door will unlock.

**Tip:** After the anti-crease phase, the washer-dryer switches off. The door is unlocked automatically. The control field will be completely dark.

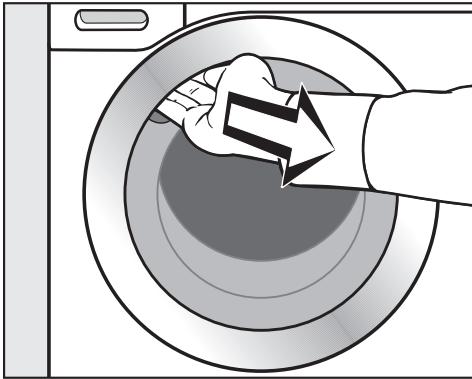

- Reach under the recessed grip and pull the door open.

**Tip:** Leave the door slightly open to allow the drum to dry.

Initial commissioning is now complete.

# Environmentally friendly washing and drying

---

## Energy and water consumption

- Use the maximum load size for the current wash programme. The energy and water consumption will then be the lowest in relation to the size of the load.
- Programmes that are more efficient with regard to energy and water consumption generally have a longer programme running time. By extending the programme running time, the wash temperature that is actually reached can be reduced while still providing the same wash results. For example, the *ECO 40-60* programme has a longer programme running time than the *Cottons 40 °C* or *60 °C* programme. The *ECO 40-60* programme is more efficient in terms of energy and water consumption.
- Use the *Express* programme for small, lightly soiled loads.
- Modern detergents make it possible to wash at lower temperatures (e.g. 20 °C). Using lower temperature settings will save energy.
- To maintain the hygiene of the washer-dryer, carry out a hot wash (above 60 °C) at regular intervals. The **i** indicator light lights up in the control field and **!** appears on the time display of the washer-dryer to remind you.

## Detergent

- Do not exceed the amounts of detergent recommended by the manufacturer on the packaging.
- Adjust the dosage to the degree of soiling of the laundry.
- Reduce the amount of detergent with smaller loads (approx. 1/3 less than the amount recommended can be used when washing a half load).

## When drying with a tumble dryer

To save energy when tumble drying, select the highest possible spin speed for the wash programme and for the thermo-spin.

## 1. Prepare the laundry

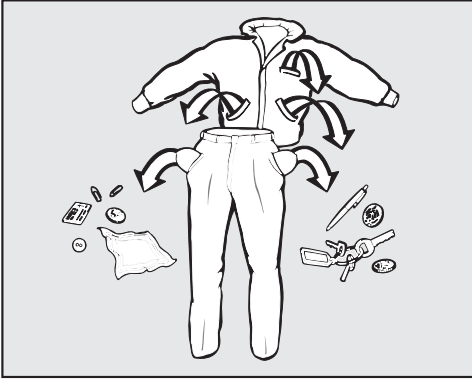

- Empty all pockets.

**⚠** Damage due to foreign objects. Nails, coins, paper clips, etc. can cause damage to garments and components inside the machine. Check laundry before washing and remove any foreign objects.

### Sort the laundry

- Sort the laundry by colour and by care label. Most garments have a textile care label in the collar or side seam.

**Tip:** Dark textiles often contain excess dye and should be washed separately several times before being included in a mixed load. Always wash whites and colours separately.

### Pre-treating stains

- Badly soiled areas and stains should be cleaned as soon as possible, preferably whilst still fresh. Stains should be carefully dabbed off using a soft, colourfast cloth. Do not rub.

**⚠** Damage due to solvent-based cleaning agents. Cleaning agents containing benzene, stain remover, etc. can damage plastic parts. When pre-treating textiles, make sure that plastic parts do not come into contact with the cleaning agent.

**⚠** Risk of explosion due to solvent-based cleaning agents. If solvent-based cleaning agents are used, an explosive mixture can form. Never use solvent-based cleaning agents in the washer-dryer.

### General tips

- Curtains: remove rollers and lead weights or place in a laundry bag.
- Sew in or remove any loose underwiring in bras.
- Close any zips, attach velcro fasteners, fasten hooks and eyes, etc. before washing.
- Fasten duvet covers and pillow cases to prevent small items from becoming rolled up inside them.

Do not wash items which are specified by the manufacturer as **not washable** according to the symbol on the care label ( symbol).

# WASHING

## 2. Loading the washer-dryer

### Open the door

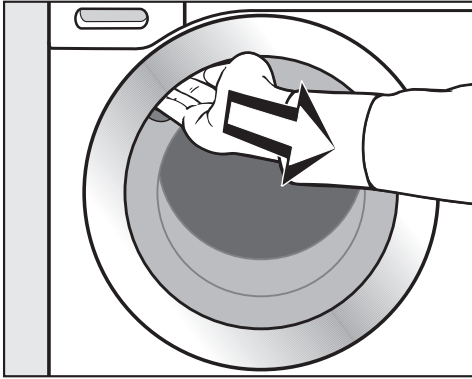

- Reach under the recessed grip and pull the door open.

Check the drum for pets or foreign objects before loading it with laundry.

- Unfold the laundry and load loosely into the drum.

Mixing both large and small items gives better wash results and also helps to distribute the load evenly during spinning.

The most efficient use of energy and water consumption is achieved when a full load is washed. However, do not overload as this reduces cleaning efficiency and causes creasing.

**Tip:** Please note the maximum load size for different wash programmes.

### Close the door

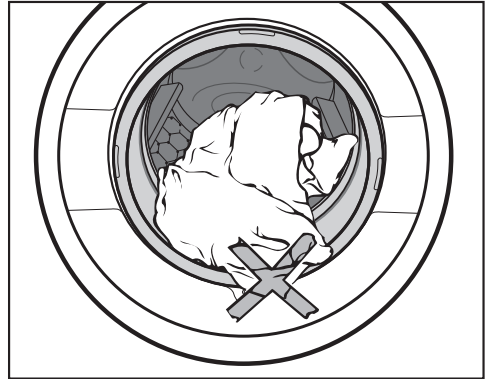

- Make sure that no items are caught between the door and the sealing ring.

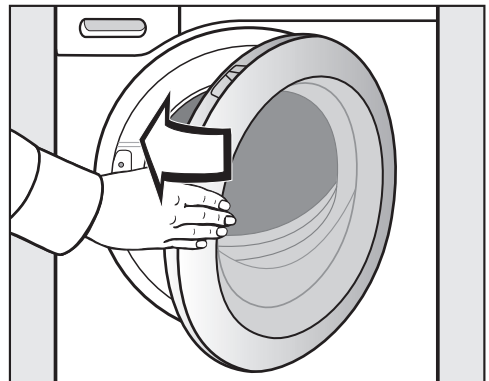

- Shut the door with a gentle swing.

## 3. Selecting a programme

### Switching the washer-dryer on

- Turn the programme selector to a programme.

The control field lights up.

### Selecting a programme

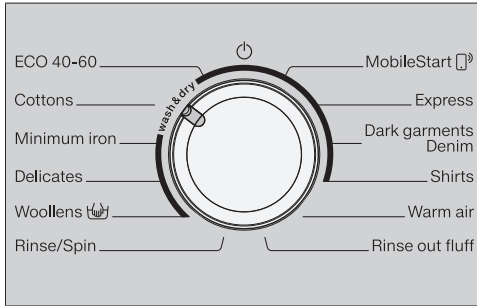

- Turn the programme selector to the required programme.

The estimated wash time is shown on the time display and the pre-set temperature and spin speed light up in the control field.

### - Using the *MobileStart* programme selector position

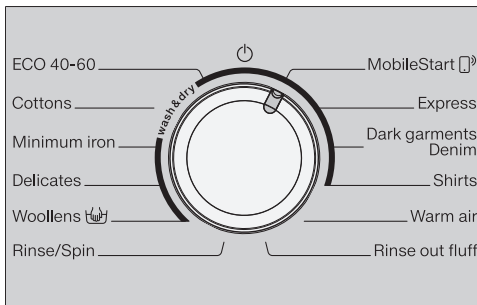

- Turn the programme selector to the *MobileStart* (with a smartphone icon) position.

**Tip:** In order to use *MobileStart* (with a smartphone icon), the washer-dryer must be logged on to the WiFi network and *Remote control* must be switched on.

*On* appears on the time display.

Once the programme has started, the washer-dryer can be operated with the Miele app.

### Selecting washing

- Touch the *Washing* or *Drying* sensor control until just the *Washing* sensor control is brightly lit up.



The *Drying* sensor control must only light up dimly as otherwise the wash programme would be followed immediately by the relevant drying programme.

# WASHING

## Selecting a temperature and spin speed

The wash programme's pre-set temperature and spin speed light up brightly. The choice of available temperatures and spin speeds for the wash programme light up dimly.

The temperatures reached in the wash programme might not be the same as the temperatures selected. Perfect wash results are achieved through a combination of energy use and wash duration.

90	1500
60	1200
40	900
30	600
20	
Cold	

- Touch the sensor control for the temperature you want.

The sensor control lights up brightly.

- Touch the sensor control for the spin speed you want.

The sensor control lights up brightly.

## Selecting extra options

The sensor controls for the *Short* and *Gentle* extra options light up dimly when they can be selected in addition to the programme.

- Touch the sensor control for the extra option you want.

The sensor control lights up brightly.

### Gentle

Drum rotation and wash duration are reduced. Lightly soiled fabrics are washed more gently.

### Short

For textiles with light soiling with no visible stains.

The duration of the main wash is reduced.

## Selecting the delay start function

You can use delay start to set the start time for a programme.

- Select a delay start time if required.

Please see "Delay start/SmartStart" for more information.



## 4. Adding detergent

Detergent is dispensed either via the detergent drawer (A) or with Cap dosing (B).



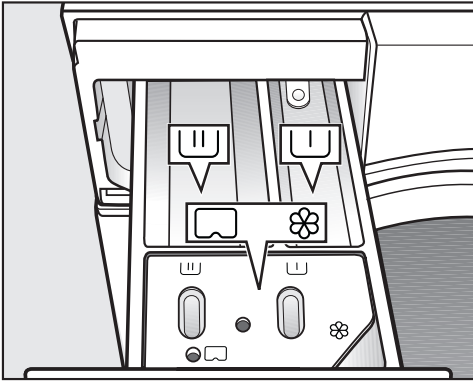

### (A) Detergent drawer

Any detergent suitable for domestic washing machines can be used. Please observe the instructions for use and dosage on the detergent packaging.

#### Adding detergent





- Pull out the detergent drawer and add detergents to the compartments.

-  No use
-  Detergent for the main wash
-  Fabric conditioner, liquid starch or capsules
- 

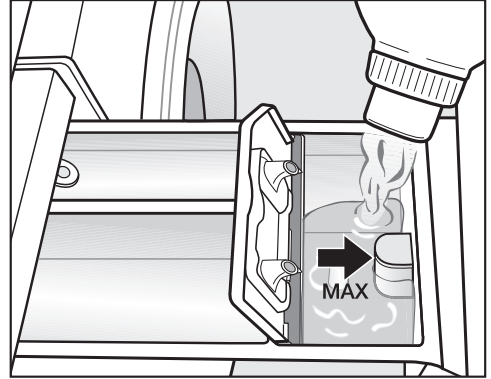
### Adding fabric conditioner



- Add fabric conditioner or liquid starch to the  compartment. **Do not exceed the maximum level mark.**

This will be automatically dispensed in the final rinse cycle. At the end of the wash programme a small amount of water remains in the  compartment.

If starching frequently, thoroughly clean the detergent drawer, especially the siphon, regularly.

# WASHING

## Tips on dispensing

Adjust the detergent dosage to the degree of soiling of the laundry and the load size. Reduce the amount of detergent with smaller load sizes (e.g. reduce the amount of detergent by  $\frac{1}{3}$  when washing a half load).

### Too little detergent:

- Results in laundry not being cleaned properly and may cause it to become grey and hard to the touch over time
- Can lead to a build-up of mould in the washer-dryer
- Results in grease not being completely removed from the laundry
- Can lead to limescale deposits on the heater elements

### Too much detergent:

- Causes poor wash, rinse and spin results
- Causes higher water consumption as an extra rinse cycle is automatically activated
- Is a greater burden on the environment

See “Washing” – “Detergent” for further information about detergents and how much to dispense.



## Using detergent tablets or pods

Always put detergent tablets or pods directly in the drum with the laundry. They cannot be added via the detergent drawer.

## Ⓑ CapDosing

CapDosing can only be activated via the Miele app.

3 different types of capsule are available:

-  = Fabric care (e.g. fabric conditioner, proofing agent)
-  = Additives (e.g. detergent enhancer)
-  = Detergent (for the main wash only)

Each capsule contains the correct amount for one wash cycle.



Capsules are available from [www.shop.miele.com](http://www.shop.miele.com), the Miele Customer Service Department or your Miele dealer.

 Capsules pose a health risk. The ingredients of capsules can be hazardous to health if they are swallowed or come into contact with skin. Keep capsules out of the reach of children.

## Inserting a capsule

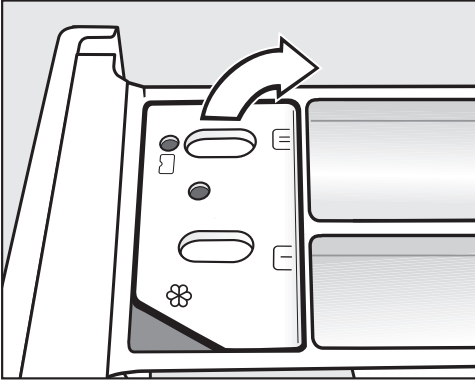
- Open the detergent drawer.



- Open the lid of the /  compartment.

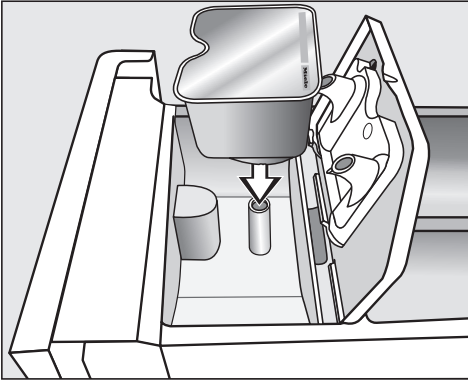

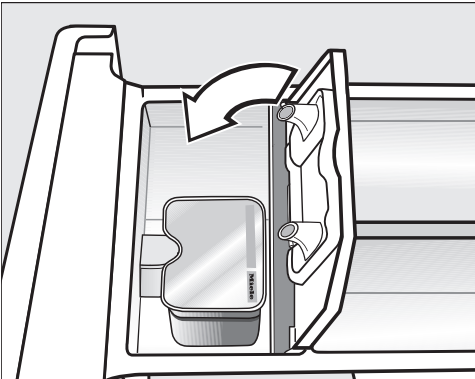

- Press the capsule in firmly.



- Close the lid and press it firmly shut.
- Close the detergent drawer.

The capsule is opened by the act of inserting it into the detergent drawer. The contents can run out of the capsule if you then remove it from the detergent drawer before it is used. Dispose of the capsule and do not reuse it.

The wash programme will dispense the contents of the capsule at the correct time.

When using CapDosing, water intake to the  compartment takes place solely via the capsule. When using capsules, do not add fabric conditioner to the  compartment.

- Remove the empty capsule at the end of the programme.

For technical reasons, a small amount of water will remain in the capsule.

# WASHING

## 5. Starting the programme

- Touch the flashing *Start/Add laundry* sensor control.

The door will lock and the wash programme will start.

If a delay start period has been selected, this counts down on the time display. At the end of the delay start period or immediately after the programme has started, the programme running time appears on the time display.

Laundry can be added or removed at any time, provided that the  symbol is not illuminated in the display (see “Changing the programme sequence – Adding laundry”).

## Saving energy

After 10 minutes, the indicators dim. The *Start/Add laundry* sensor control flashes slowly.



To reactivate the indicators:

- Touch the *Start/Add laundry* sensor control (this does not have any effect on a programme that is running).

## 6. End of the programme/unloading laundry

In the anti-crease phase, the drum continues to turn for up to 30 minutes after the end of the programme. The door is locked. The control field lights up for the first 10 minutes. The control field then goes out and the *Start/Add laundry* sensor control flashes.

- Turn the programme selector to the  position.

 appears on the time display and the  indicator light goes out.

The door will unlock.

**Tip:** The door unlocks automatically at the end of the anti-crease phase.

- Pull open the door.
- Remove the laundry.

Items left in the drum could discolour other items in the next wash or become discoloured themselves. Remove all items from the drum.

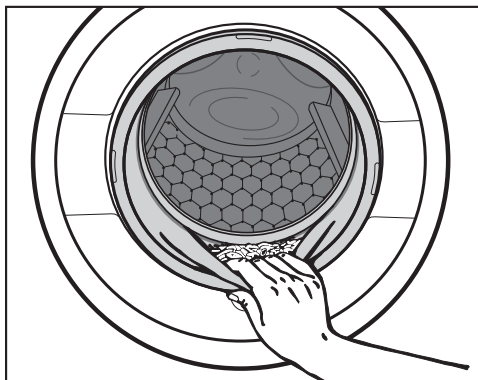

- Check the door sealing ring for any foreign objects.

**Tip:** Leave the door slightly open to allow the drum to dry.

- If applicable, remove the used capsule from the detergent drawer.

**Tip:** Leave the detergent drawer slightly open to allow it to dry.

## Spin speeds

### Final spin speed in wash programme

When a programme is selected, the sensor control for the optimum spin speed for that wash programme will be brightly lit up in the control field.

A faster spin speed can be selected for certain wash programmes.

The highest selectable spin speed is indicated in the table.

Programme	rpm
ECO 40-60	1500
Cottons	1500
Minimum iron	1200
Delicates	900
Woolens	1200
Rinse/Spin	1500
Express	1200
Dark garments/Denim	900
Shirts	900

### Rinse-spin

There is a spin cycle after the main wash and between the rinse cycles. A reduction in the final spin speed will also reduce the rinse-spin speed as appropriate.

### Omitting the final spin (Rinse hold)

- Touch the  sensor control (Rinse hold).

The laundry is not spun after the final rinse cycle and remains in the rinse water. This helps prevent creasing if the laundry is not going to be removed from the washer-dryer immediately after the end of the programme.

#### To start the final spin:

The sensor control for the optimum spin speed lights up in the control field. You can change the spin speed.

- Start the final spin with the *Start/Add laundry* sensor control.

#### To end the programme:

- Touch the  sensor control (no spin).
- Touch the *Start/Add laundry* sensor control.

The water will be pumped away.

### Omitting the rinse-spin and the final spin



- Touch the  sensor control (no spin).

After the last rinse, the water will be pumped away and the anti-crease phase will switch on.



In some programmes, an extra rinse is introduced with this setting.

# WASHING

## Programme chart

















ECO 40-60		Max. load 8.0 kg	
Use for	Normally soiled cotton garments		
Tip	<ul style="list-style-type: none"> <li>- A laundry load consisting of mixed cottons that are intended for washing at 40 °C or 60 °C can be washed in the same wash cycle.</li> <li>- This programme is the most efficient in terms of energy and water consumption for washing cottons.</li> </ul>		
<p><b>Note for test institutes:</b> test programme for compliance with EU legislation regarding ecodesign No. 2019/2023 and energy labelling in accordance with Regulation No. 2019/2014.</p>			
<p><b>Note for test institutes:</b> the following switchover must be made for the test programme in accordance with EN 60456:</p> <ul style="list-style-type: none"> <li>- When selecting the <i>ECO 40-60</i> programme, the temperature 60 °C lights up dimly in the temperature display.</li> <li>- Touch the <i>temperature</i> 60 sensor control. Temperature 60 lights up brightly. The <i>Cottons</i>  test programme is selected.</li> </ul>			
Cottons		90 °C to cold	Max. load 8.0 kg
Use for	Cotton, linen or mixed fibre fabric, e.g. table linen, underwear, T-shirts, etc.		
Tip	<ul style="list-style-type: none"> <li>- Select the temperature according to the instructions on the care label, the detergent, the type of soiling and the hygiene requirements.</li> <li>- 20 °C programme for lightly soiled cotton garments.</li> </ul>		
Minimum iron		60 °C to cold	Max. load 3.5 kg
Items	Synthetic and mixed fibre fabric and easy care cotton		
Tip	Reduce the spin speed for items which crease easily.		
Delicates		40 °C to cold	Max. load 2.0 kg
Use for	Delicate garments made from synthetic fibre, mixed fibre and viscose		
Tip	Deselect the spin speed for items which crease easily.		
Woollens 		40 °C to cold	Max. load 2.0 kg
Items	Wool or wool blend fabric		
Tip	Reduce the final spin speed for fabric that creases easily.		

## WASHING

<b>Rinse/Spin</b>		<b>Max. load 8.0 kg</b>
Use for	Rinsing and spinning hand-washed items	
Tip	<ul style="list-style-type: none"> <li>- Make sure you select the appropriate spin speed.</li> <li>- Spin only: select the <i>Short</i> extra option.</li> <li>- Rinse only: set spin speed to .</li> </ul>	
<b>MobileStart</b> 		
Tip	The Miele app is used for selecting programmes and operating the appliance.	
<b>Express</b>		<b>40 °C to cold</b> <b>Max. load 3.5 kg</b>
Items	Cotton garments that have hardly been worn or are only very lightly soiled	
<b>Dark garments/Denim</b>		<b>60 °C to cold</b> <b>Max. load 3.0 kg</b>
Use for	Black and dark items made of cotton, mixed fibre or denim	
Tip	<ul style="list-style-type: none"> <li>- Wash inside out.</li> <li>- Denim often contains excess dye and may run during the first few washes. Therefore, wash light and coloured items separately.</li> </ul>	
<b>Shirts</b>		<b>40 °C to cold</b> <b>Max. load 2.0 kg</b>
Use for	Shirts and blouses made of cotton and mixed fibre	
Tip	<ul style="list-style-type: none"> <li>- Pre-treat collars and cuffs depending on the level of soiling.</li> <li>- Turn shirts and blouses inside out, do up buttons and turn collars and cuffs inwards.</li> </ul>	
<b>Warm air</b>	⇨ “Programme chart – DRYING”	
<b>Rinse out fluff</b>	⇨ “Rinse out fluff programme” section	



# WASHING

## Programme sequence

	Main wash		Rinse		Spin
	Water level	Wash rhythm	Water level	Rinse cycles	
ECO 40-60		Ⓐ		2-3 <sup>2</sup>	✓
Cottons		Ⓐ		2-4 <sup>1,2</sup>	✓
Minimum iron		Ⓑ		2-3 <sup>2</sup>	✓
Delicates		Ⓒ		2-3 <sup>2</sup>	✓
Woollens		Ⓔ		2	✓
Rinse/Spin	-	-		1	✓
Express		Ⓐ		1	✓
Dark garments		Ⓑ		3-4 <sup>2</sup>	✓
Shirts		Ⓒ		3	✓

Please see the next page for a description of the symbols.



-  = low water level
-  = medium water level
-  = high water level
- Ⓐ = intensive rhythm
- Ⓑ = normal rhythm
- Ⓒ = sensitive rhythm
- Ⓔ = hand wash rhythm
- ✓ = carried out
- = not carried out

This washer-dryer has fully electronic controls with automatic load control. The washer-dryer takes in the right amount of water required for the programme depending on the amount of laundry and its absorbency rate.

The programme sequences outlined are based on the standard programme with a full load.

### Special features in the programme sequence

#### Anti-crease:

At the end of the programme, the drum continues to turn for up to 30 minutes to help prevent creasing.

Exception: there is no anti-crease phase in the *Woolens* programme.

The washer-dryer can be opened at any time.

<sup>1</sup> If a temperature of 60 °C or higher is selected, 2 rinse cycles are carried out. If a temperature of less than 60 °C is selected, 3 rinse cycles are carried out.

<sup>2</sup> An extra rinse is carried out if:

- There is too much foam in the drum
- The spin speed is less than 700 rpm

## Detergent

All detergents produced for automatic washing machines are suitable. Follow the manufacturer's instructions and dosage recommendations on the packaging.

### The dispensing quantity will depend on:

- The degree of soiling of the laundry
- The amount of laundry
- The water hardness

Check with your local water supplier if you do not know the water hardness level in your area.

## Water softeners

A water softener can be used to cut down on the use of detergents in areas with water hardness levels II and III. Dispense according to the amount specified on the packaging. First add detergent and then the water softener.

You can then use the recommended amount of detergent for water hardness level I.

## Water hardness levels

Hardness scale	Hardness level in mmol/l	German scale °d
I (soft)	0 – 1.5	0 – 8.4
II (medium)	1.5 – 2.5	8.4 – 14
III (hard)	above 2.5	above 14

# WASHING

---

## Dispensing aids

Use dispensing aids, (e.g. balls) if these are supplied with the detergent, particularly when using liquid detergent.

## Refill packs of detergent

When purchasing detergent buy refill packs wherever possible. This helps reduce the amount of waste packaging.

## Fabric conditioners, liquid starch, starch



Fabric conditioners make garments soft to handle and help prevent static cling when tumble drying.

Liquid starch is synthetic and provides good stiffness to fabric.

Starch stiffens and gives body to fabric.

## Using fabric conditioner, liquid starch or starch separately

Prepare the starch in accordance with the manufacturer's instructions on the packaging.

- Add fabric conditioner to the  compartment.
- Add liquid starch to the  compartment and powder or viscous starch to the  compartment.
- Select the *Rinse/Spin* programme.
- Change the spin speed if necessary.
- Touch the *Start/Add laundry* sensor control.

## Colour run and dye removers/dyes



 Damage due to colour run/dye removers.

Colour run and dye removers can cause corrosion in the washer-dryer. Do not use colour run or dye removers in this washer-dryer.

Dyes suitable for use in domestic washer-dryers can be used. However, please note that the salt used in the dyeing process can cause corrosion to stainless steel components in the machine if you use dye frequently. Always follow the dye manufacturer's instructions carefully.

## Recommended Miele detergents

Miele detergents have been specially designed for day-to-day use in Miele washing machines. See “Detergents and care products” for more information about these detergents.

	Miele detergents		Miele capsules		
	UltraWhite	UltraColor			
ECO 40-60	✓	✓	–	✓	✓
Cottons	✓	✓	–	✓	✓
Minimum iron	–	✓	–	✓	✓
Delicates	–	✓	✓	✓	–
Woollens	–	–	✓	–	–
Rinse/Spin	–	–	–	✓	–
Express	–	✓	–	✓	–
Dark garments/Denim	–	✓	✓	✓	–
Shirts	✓	✓	–	✓	✓

✓ Recommended

– Not recommended

 Special-purpose detergents (e.g. Wool-Care)

 Fabric care (e.g. fabric conditioner)

 Additive (e.g. booster)

# WASHING

## Recommended detergents in accordance with Directive (EU) No. 1015/2010

The recommendations apply to the temperature ranges given in the “WASHING” section in the Programme chart.

	Universal	Colour	Delicates and woollens	Special
	detergents			
ECO 40-60	✓	✓	–	–
Cottons	✓	✓	–	–
Minimum iron	–	✓	–	–
Delicates	–	–	✓	–
Woollens	–	–	✓	✓
Rinse/Spin	–	–	–	✓
Express	–	✓ <sup>1</sup>	–	–
Dark garments/ Denim	–	✓ <sup>1</sup>	–	–
Shirts	✓	✓	–	–

✓ Recommended

– Not recommended

<sup>1</sup> Liquid detergent

## Separate drying

The separate drying programme should be run if the load in the wash programme is greater than the maximum load permitted for drying, or if you only want to dry part of the load that was washed.

## 1. Prepare the laundry

### Sort the laundry

- Sort the laundry according to type of fibre/weave and the residual moisture content.

This will help you achieve an even drying result.

- Before drying, check the drying symbol on the care label.

If there is no care label, the article should only be tumble dried in a programme specially designed for it.

### Tips on drying

- Do not load the drum with items that are still soaking wet. Spin the laundry for at least 30 seconds after washing.
- Woollens and wool blends are susceptible to becoming matted or shrinking. Only use the *Woollens* programme for these textiles.
- Pure linen should only be tumble dried if it is specified as suitable on the care label. The surface of the fabric may otherwise become rough.
- Jersey fabrics (e.g. T-shirts, underwear) tend to shrink when they are washed for the first time. Therefore, do not overdry the fabrics to prevent them from shrinking further. Buy jersey garments that are one or two sizes bigger.

- Starched laundry can be tumble dried. To achieve the usual finish, double the amount of starch should be used.
- New dark coloured garments should be washed and dried separately from light coloured garments. The colour of dark garments can run or fluff from garments of other colours may settle on them.
- Observe the maximum loads given for the drying programmes in the Programme chart.  
The drying result and amount of creasing depend on the size of the load. The smaller the load in the dryer, the better the result. Therefore, if you reduce the load, you will achieve a more even drying result with less creasing.

# DRYING

## 2. Loading the washer-dryer

### Open the door

- Reach under the door grip and pull the door open.

Check the drum for pets or foreign objects before loading it with laundry.

- Load the laundry loosely in the drum.

Overloading places a strain on the textiles and affects drying results. Observe the maximum loads given in the “Programme chart”.

### Close the door

- Make sure that no items are caught between the door and the seal.
- Shut the door with a gentle swing.

Detergent dispensing aids, e.g. plastic dispenser balls, can melt during the drying programme and cause damage to the machine and the laundry.

These dispensing aids must be removed from laundry before drying.

The water supply stopcock must be kept open for drying.

## 3. Selecting a programme

### Switching the washer-dryer on

- Turn the programme selector to a programme.

The control field lights up.

### Selecting a programme

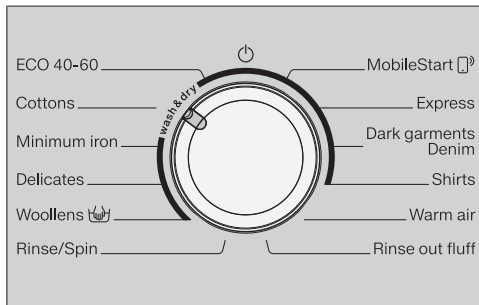

- Turn the programme selector to the required programme.

The estimated wash time is shown on the time display and the pre-set temperature and spin speed light up in the control field.

### - Using the *MobileStart* programme selector position

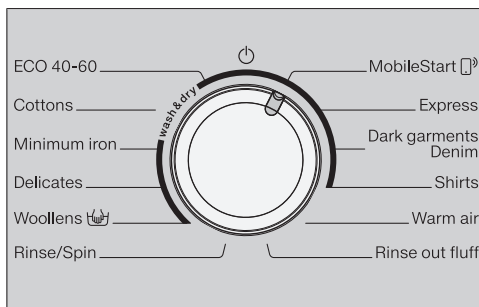

- Turn the programme selector to the *MobileStart* (with a square icon) position.

**Tip:** In order to use *MobileStart* , the washer-dryer must be logged on to the WiFi network and *Remote control* must be switched on.

*On* appears on the time display.

Once the programme has started, the washer-dryer can be operated with the Miele app.

## Selecting drying



- Touch the *Washing* or *Drying* sensor control until just the *Drying* sensor control is brightly lit up.

The *Washing* sensor control must only light up dimly as otherwise the relevant wash programme would begin before the drying process.

## 4. Select programme settings

### Selecting the drying level

The pre-set drying level for a drying programme can be changed if required.

- Touch the sensor control for the drying level you want.
  -  Normal plus
  -  Normal
  -  Hand iron

The sensor control for the selected drying level lights up brightly.

**Warm air programme:** Select the drying time with the < or > sensor controls.

## Selecting a thermospin spin speed

The preset thermospin spin speed for a drying programme can be changed if required.

- Touch the sensor control for the spin speed you want.

The sensor control lights up brightly.

## Selecting extra options

The sensor controls for the *Gentle* extra option light up dimly if the *Gentle* option can be selected in addition to the programme.

- Touch the *Gentle* sensor control.

The sensor control lights up brightly.

### Gentle

Delicate textiles such as acrylics are dried gently (care label symbol .

The programme running time will increase when *Gentle* option is selected because of the lower temperature.

## Selecting the delay start function

You can use delay start to set the start time for a programme.

- Select a delay start time if required.

Please see “Delay start/SmartStart” for more information.

# DRYING

## 5. Starting the programme

- Touch the flashing *Start/Add laundry* sensor control.

The door will lock and the drying programme will start.

If a delay start period has been selected, this counts down on the time display. At the end of the delay start period or immediately after the programme has started, the programme running time appears on the time display.

Laundry can be added or removed at any time, provided that the  symbol is not illuminated in the display (see “Changing the programme sequence – Adding laundry”).

## Saving energy

After 10 minutes, the indicators dim. The *Start/Add laundry* sensor control flashes slowly.

To reactivate the indicators:

- Touch the *Start/Add laundry* sensor control (this does not have any effect on a programme that is running).

## 6. End of the programme/unloading laundry

In the anti-crease phase, the drum continues to turn for up to 150 minutes after the end of the programme. The door is locked. The control field lights up for the first 10 minutes. The control field then goes out and the *Start/Add laundry* sensor control flashes.

- Turn the programme selector to the  position.

The door will unlock.

If you unload the laundry during the anti-crease phase, heat can build up. Spread the laundry out to cool it down.

The door unlocks automatically at the end of the anti-crease phase.

- Pull open the door.
- Remove the laundry.













Items left in the dryer could be damaged by overdrying when the dryer is used the next time.  
Remove all items from the drum.

**Tip:** See “Washing and drying – After each washing or drying programme”.













## Programme chart

\* Weights are based on the weight of dry laundry.

<b>ECO 40-60</b>		<b>Max. load 5.0 kg*</b>
<b>Drying levels:</b>  		
	Cotton textiles: T-shirts, underwear, baby clothes, workwear, jackets, covers, aprons, overalls, hand towels/bath towels/bathrobes and flannelette/bed linen.	
<b>Cottons</b>		<b>Max. load 5.0 kg*</b>
<b>Drying levels:</b>   		
Use for	Single and multi-layered cotton fabric such as T-shirts, underwear, baby clothes, workwear, jackets, covers, aprons, overalls, hand towels/bath towels/bathrobes and flannelette/bed linen.	
<b>Drying levels:</b> 		
Use for	Cotton or linen fabric requiring further processing, e.g. table linen, bed linen, starched laundry.	
Tip	To prevent laundry from drying out, it should be rolled up until you are ready for ironing.	
<b>Minimum iron</b>		<b>Max. load 3.5 kg*</b>
<b>Drying levels:</b>   		
Use for	Minimum iron items made of cotton, synthetic or mixed fibre, e.g. workwear, overalls, jumpers, dresses, trousers, table linen, tights.	
<b>Delicates</b>		<b>Max. load 1.0 kg*</b>
<b>Drying levels:</b>   		
Use for	Delicate items with the  symbol on the care label made of synthetic fibres, artificial silk, easy care cotton or mixed fibres, e.g. shirts, blouses, lingerie and evening wear with sequins and beading.	
Tip	Reducing the load will reduce creasing.	

## DRYING

<b>Woollens</b>		<b>Max. load 2.0 kg*</b>
<b>3 minutes</b>		
Use for	Woollen garments and fabric containing wool blends, e.g. pullovers, cardigans, tights	
Tip	<ul style="list-style-type: none"> <li>- Wool and wool blend items are only fluffed up; they are not dried completely.</li> <li>- Remove the garments immediately after the end of the programme.</li> </ul>	
<b>MobileStart </b>		
Tip	The Miele app is used for selecting programmes and operating the appliance.	
<b>Express</b>		<b>Max. load 3.5 kg*</b>
<b>Drying levels:</b>  ,  , 		
Use for	Items suitable for the Cottons programme	
Note	The programme running time for this programme is particularly short when washing and drying <b>lightly</b> soiled laundry in a continuous sequence.	
<b>Dark garments/Denim</b>		<b>Max. load 3.0 kg*</b>
<b>Drying levels:</b>  ,  , 		
Use for	Black and dark items made of cotton, mixed fibre or denim	
<b>Shirts</b>		<b>Max. load 1.0 kg*</b>
<b>Drying levels:</b>  ,  , 		
Use for	Shirts and blouses	
Tip	- Turn shirts and blouses inside out, do up buttons and turn collars and cuffs inwards.	

<b>Warm air</b>		<b>Max. load 4.0 kg*</b>
<b>20–120 minutes</b>		
Tip	<ul style="list-style-type: none"><li>- Additional drying for multi-layered items whose layers have different drying characteristics, e.g. jackets, pillows, sleeping bags</li><li>- For drying and airing individual items</li></ul>	
<b>Rinse out fluff</b>		⇒ See “Rinse out fluff” section.

## Thermospin

A thermospin is carried out in some drying programmes to reduce energy consumption.

The maximum spin speed for the thermospin is the maximum permitted spin speed for the appropriate wash programme.

The thermospin spin speed can be reduced in some programmes to 900 rpm.

# WASHING AND DRYING

## Washing and drying in one continuous sequence

It is advisable to wash and dry in a continuous sequence when the amount of laundry to be washed does not exceed the amount to be dried and the amount to be dried does not exceed the permitted dry weight for the programme.

It is very important to read the sections “Separate washing” and “Separate drying” before proceeding.

### 1. Prepare the laundry

- Empty all pockets.
- Sort the laundry according to colour and type of fibre/weave.
- Check the symbols on the care labels.

### 2. Loading the washer-dryer

- Open the door.

Check the drum for pets or foreign objects before loading it with laundry.

- Unfold the laundry and load loosely into the drum.

Detergent dispensing aids, e.g. plastic dispenser balls, can melt during the drying programme and cause damage to the washer-dryer and the laundry.

These dispensing aids must be removed from the laundry before drying.

- Close the door.

### 3. Selecting a programme

- Turn the programme selector and select the required programme.

The control field lights up.

- Touch the *Washing* and *Drying* sensor control until both sensor controls are brightly lit up.

### 4. Selecting programme settings

- Select the desired spin speed, temperature and drying level.

The sensor controls for the selected settings light up brightly.

The minimum spin speed cannot be lower than 900 rpm.  
For some programmes the spin speed cannot be changed.

- Select further extra options as required.

With the thermospin, the spin speed displayed for the wash cycle is used.

- Select a delay start time if required.

## 5. Add detergent

- Dispense detergent either with Cap dosing or via the detergent dispenser drawer.

## 6. Programme start/finish

- Touch the flashing *Start/Add laundry* sensor control.

The door is locked.

The programme will start.

The anti-crease phase will start at the end of the programme.

The door remains locked during the anti-crease phase.

- Touch the *Start/Add laundry* control or turn the programme selector to the  position.

The door will unlock.

If you have unloaded the drum during the anti-crease phase make sure you spread out the laundry to allow it to cool down.

The door unlocks automatically at the end of the anti-crease phase.

- Pull the door open and unload the laundry.

See “After each washing or drying programme”.

## After each washing or drying programme

- Open the door **fully**.

 Risk of burning due to hot metal. The metal cap located on the inside of the door glass will be hot after drying. Do not touch the metal cap.

- Remove the laundry.

Laundry left in the drum could shrink, discolour or be damaged in the next washing or drying programme. Check that all items have been removed from the drum.

- Check the door sealing ring for any foreign objects. After drying, remove any fluff from around the door sealing ring and the door glass.

**Tip:** Leave the door slightly open to allow the drum to dry.

- Turn the programme selector to the  position.

**Tip:** Leave the detergent drawer slightly open to allow it to dry.

## Rinse out fluff programme

---

During drying, fluff develops and can collect in the drum and suds container. You can rinse out fluff before the machine is used again so that this fluff (e.g. from dark coloured textiles) cannot be deposited on other items (e.g. light coloured textiles) in the next load or cause a blockage in the washer-dryer.

The *Rinse out fluff programme* must not be used for rinsing laundry. Ensure there are no items of laundry in the drum before starting the programme.

- Turn the programme selector to the *Rinse out fluff* programme.

Do not use detergent.

- Touch the *Start/Add laundry* sensor. Any fluff will be rinsed away within a few minutes.
- If necessary wipe any remaining fluff off the door sealing ring and door glass.
- Switch the washer-dryer off.

# Changing the programme sequence

## Changing a programme (safety lock)

A programme, temperature, spin speed or selected options cannot be changed once the machine has been successfully started. This prevents the machine being operated unintentionally, e.g. by children.

If the washer-dryer is switched off during active programme operation, the standby function does not switch the washer-dryer off completely after 15 minutes. Safety functions continue to be active because there may still be water inside the drum.



## Cancelling a programme

You can cancel a programme at any time after it has started.

- Turn the programme selector to the  position.

The programme is interrupted.

- Then turn the programme selector to any position.

Rotating bars  ...  ...  appear on the time display.

- During washing:

The washer-dryer pumps the suds away and the wash programme is cancelled.

The door lock is released.

- During drying:

The washer-dryer cools the laundry down before the door can be opened.

## Removing the laundry

- Wait until the  symbol in the display goes out and the door is unlocked.
- Pull the door open and unload the laundry.

## Selecting another programme

- Close the door.
- Select the programme you want to use.
- Add detergent to the detergent drawer, if necessary.
- Touch the *Start/Add laundry* sensor.



The programme will start.

## Adding laundry - AddLoad

You can add or remove laundry items during the first few minutes after the programme has started.

Laundry **cannot** be added if the  symbol is illuminated in the display.

- Touch the *Start/Add laundry* sensor control.

Rotating bars  ...  ...  appear on the time display.

*Add* appears on the time display.

- Open the door.
- Add or remove laundry.
- Close the door.
- Touch the *Start/Add laundry* sensor control.

The programme continues.

Laundry cannot be added or removed if:

- The suds temperature is above 55 °C
- The water inside the drum is above a certain level

# Delay start/SmartStart

## Delay start

Delay start is active when the *P98* SmartGrid programmable function is switched off.

With delay start, you can delay the start of a programme from 30 minutes up to a maximum of 24 hours. This allows you to make use of night-time economy electricity rates, for example.

### Setting the delay start time

- Select the wash programme required.
- Touch the  sensor control.

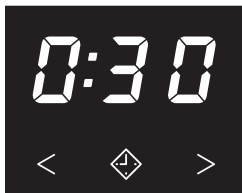

The  sensor control lights up brightly.

- Touch the < or > sensor control repeatedly until the required delay start time appears on the time display.
- In the case of settings below 10 hours, the delay start time changes in increments of 30 minutes.
- In the case of settings above 10 hours, the delay start time changes in increments of 1 hour.

## Starting delay start





- Touch the flashing *Start/Add laundry* sensor control.

The delay start process starts and counts down on the time display.

## Changing or cancelling delay start

If the selected delay start function has started, it is no longer possible to change the time.

- Turn the programme selector to the  position.
- Turn the programme selector to any programme.

Rotating bars  ...  ...  or  are shown on the time display.

The delay start process stops.

- Select a programme and a new delay start time.



## SmartStart

The *SmartStart* function is active when the *P98 SmartGrid* programmable function is switched on.

The SmartStart function lets you define a time period during which your washer-dryer will start automatically based on an external signal. The appliance will start on receipt of a signal, e.g. from your energy supplier, that indicates that the electricity tariff is particularly economical.

The time period can be defined between 30 minutes and 24 hours. During this period, the washer-dryer waits for the external signal. If no signal is sent during the defined period, the washer-dryer starts the programme.

## Setting the time period

If the *P98 SmartGrid* programming functions are activated, the function of the  sensor control changes. The time display no longer shows the delay start period, and instead shows the time period in which your washer-dryer can be started automatically (see “Programmable functions – *P98 SmartGrid*”).

The procedure for setting this is the same as for setting the delay start time.

- Touch the  sensor control.
- Set the time period you want using the < or > sensor controls.
- Touch the Start/Add laundry sensor control.

 appears on the time display.

## Cleaning and care

### Cleaning the casing and control panel

**⚠** Risk of electric shock from mains voltage.

The mains voltage is applied to the washer-dryer even if it is switched off.

Disconnect the power plug before cleaning or maintenance.

**⚠** Risk of damage due to ingress of water.

The pressure of a water jet can cause water to get into the washer-dryer, resulting in damage to components.

Do not spray the washer-dryer with a water jet.

**⚠** Damage caused by cleaning agents.

Solvent-based cleaning agents, abrasive cleaners, glass cleaners or multi-purpose cleaning agents can cause damage to plastic surfaces and other parts.

Do not use these cleaning agents.

- Clean the casing and control panel with a mild cleaning agent or soap and water and dry both with a soft cloth.
- The drum can be cleaned using a suitable stainless steel cleaning agent.

### Cleaning the detergent dispenser drawer

Washing at low temperatures and the use of liquid detergent can lead to a build-up of mould and bacteria in the detergent dispenser drawer.

- For hygiene reasons, clean the entire drawer at regular intervals.

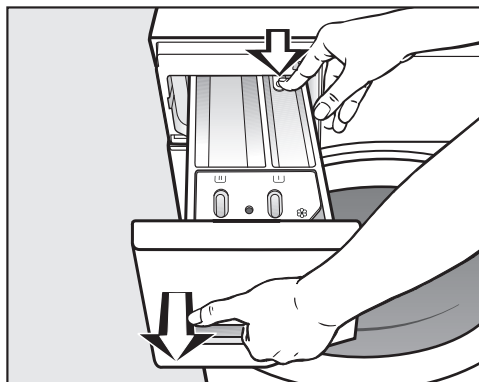

- Pull out the detergent dispenser drawer until a resistance is felt. Press down the release button and at the same time pull the drawer right out of the machine.
- Clean the drawer with hot water.

## Cleaning the siphon and the channel

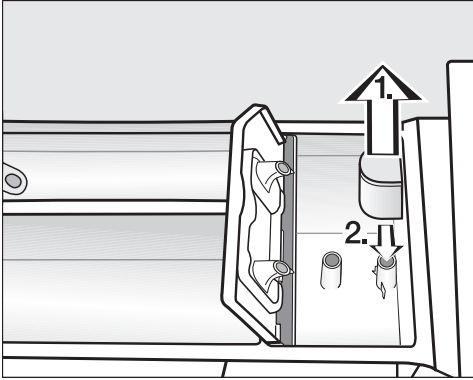

- Pull the siphon out of the compartment and clean it under warm running water.
- Clean the siphon tube in the same way.
- Refit the siphon.

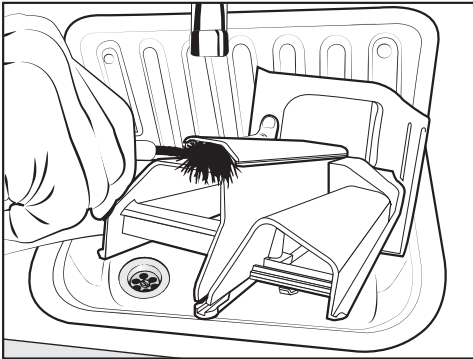

- Clean the fabric conditioner channel using a brush and warm water.

Liquid starch results in clogging.  
Clean the siphon particularly thoroughly after using liquid starch a few times.

## Cleaning the detergent dispenser drawer housing

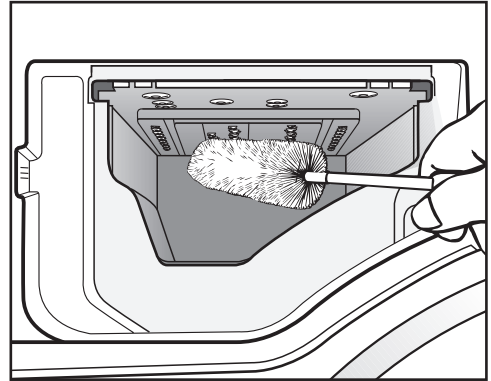

- Use a bottle brush to remove detergent residues and limescale from the jets inside the detergent dispenser drawer housing.
- Replace the detergent dispenser drawer.

**Tip:** Leave the detergent dispenser drawer slightly open to allow it to dry.

# Cleaning and care

## Cleaning the porthole glass

- Clean the inside of the porthole glass from time to time and the metal cap inside the porthole glass with a suitable mild cleaning agent or with soapy water.
- Dry both with a soft cloth.

## Cleaning the drum

Washing at low temperatures and/or using liquid detergent can cause bacteria and unpleasant odours to build up in the washer-dryer. Use the *Cottons 90 °C* programme to clean the washer-dryer. Clean the drum no later than the point at which the **i** indicator light and **7** light up on the time display.

## Cleaning the water intake filter

The washer-dryer has a filter to protect the water intake valve. The filter at the open end of the water inlet hose should be checked approximately every 6 months. Perform this check more often if there are frequent interruptions to the external water supply.

- First turn off the stopcock.
- Unscrew the water inlet hose from the stopcock.

- Remove the rubber seal **1** from the recess.
- Hold the free end of the water inlet hose upside down. The plastic filter **2** will fall out.
- Clean the plastic filter.
- Reassemble in reverse order.
- Turn on the stopcock and check that the connection is watertight. If water drips out, tighten the connection.

**Never** forget to put the filter back in place after cleaning.

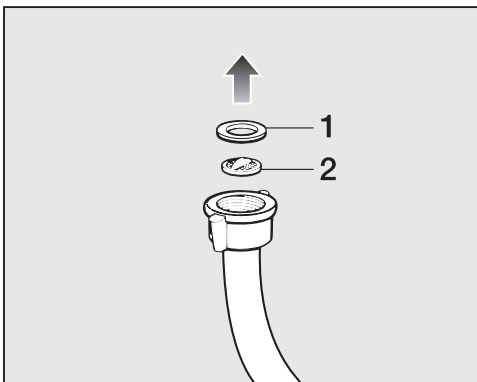

Many malfunctions and faults that can occur in daily operation can be easily remedied. You can save time and money in many cases, as you do not need to call the Miele Customer Service Department.

Information to help you rectify faults yourself can be found at [www.miele.com/service](http://www.miele.com/service).





The following tables are designed to help you to find the cause of a malfunction or a fault and to resolve it.

### A programme does not start





Problem	Cause and remedy
<b>The control field remains dark.</b>	There is no power to the washer-dryer. <ul style="list-style-type: none"><li>■ Check whether the power plug is plugged in.</li><li>■ Check whether the fuse has tripped.</li></ul>
	The washer-dryer has switched off automatically to save energy. <ul style="list-style-type: none"><li>■ Switch the washer-dryer on again by turning the programme selector.</li></ul>
<b>F and 34 alternate on the time display.</b>	The door is not closed properly. The door lock could not engage. <ul style="list-style-type: none"><li>■ Close the door again.</li><li>■ Start the programme again.</li><li>■ If the fault message appears again, contact the Miele Customer Service Department.</li></ul>

# Problem solving guide

## Programme cancellation and fault indicator light





Problem	Cause and remedy
<b>The fault indicator light  lights up. F and  alternate on the time display and the buzzer sounds.</b>	<p>The water inlet is blocked or restricted.</p> <ul style="list-style-type: none"><li>■ Check whether the stopcock has been properly opened.</li><li>■ Check whether the water inlet hose is kinked.</li><li>■ Check whether there is sufficient water pressure.</li></ul>
	<p>The filter in the water inlet is blocked.</p> <ul style="list-style-type: none"><li>■ Clean the filter.</li></ul>
<b>The fault indicator light  lights up. F and // alternate on the time display and the buzzer sounds.</b>	<p>The drain is blocked or restricted.</p> <p>The drain hose has been fixed too high.</p> <ul style="list-style-type: none"><li>■ Clean the drain filter and the drain pump.</li><li>■ Check whether the maximum delivery head of 1 m has been exceeded.</li></ul>
<b>The fault indicator light  lights up. F and  alternate on the time display and the buzzer sounds.</b>	<p>The water protection system has reacted.</p> <ul style="list-style-type: none"><li>■ Close the stopcock.</li><li>■ Call the Miele Customer Service Department.</li></ul>
<b>F and XXX alternate on the time display and the buzzer sounds.</b>	<p>There is a fault.</p> <ul style="list-style-type: none"><li>■ Disconnect the washer-dryer from the electricity supply. Switch off at the wall and withdraw the plug from the socket, or disconnect the fuse.</li><li>■ Wait <b>at least 2 minutes</b> before reconnecting the washer-dryer to the electricity supply.</li><li>■ Switch the washer-dryer back on.</li><li>■ Restart the programme.</li><li>■ If the fault message appears again, contact the Miele Customer Service Department.</li></ul>

### Fault indicator light lights up at the end of a programme

Problem	Cause and remedy
The  indicator light lights up.	Excessive foam has built up during washing. <ul style="list-style-type: none"> <li>■ Use less detergent next time and follow the manufacturer's instructions on dosage given on the packaging.</li> </ul>
The  indicator light lights up and 1 appears on the time display.	When washing, a wash programme using a temperature above 60 °C has not been run for a long time. <ul style="list-style-type: none"> <li>■ Run the <i>Cottons 90 °C</i> programme using Miele machine cleaner or a multi-purpose powder detergent.</li> </ul> <p>This will clean the washer-dryer and prevent a build-up of bacteria and odours.</p>
The  indicator light lights up and 3 appears on the time display.	The <i>Rinse out fluff</i> programme has not been used for a long time. <ul style="list-style-type: none"> <li>■ Start the <i>Rinse out fluff</i> programme as described in "Rinse out fluff".</li> </ul>
The  indicator light lights up and 4 appears on the time display.	There is no laundry in the drum.
	The load is too small. The laundry is still damp because the residual moisture content in the laundry cannot be measured. <ul style="list-style-type: none"> <li>■ In the future, use a <i>Warm air</i> programme for small amounts of laundry.</li> </ul>
	The amount of laundry exceeded the maximum load for the selected drying programme. <ul style="list-style-type: none"> <li>■ Observe the maximum load sizes given in the Programme chart.</li> </ul>

## Problem solving guide

### Symbols on the time display

Message	Cause and remedy
<b>-P-</b> is lit up on the time display.	The programme selector was moved to a different position after the programme had started. <ul style="list-style-type: none"> <li>■ Turn the programme selector back to the original position.</li> </ul>
<b>UP</b> lights up when switching on the washer-dryer.	An update is available for the washer-dryer. See “Programmable functions – P99 RemoteUpdate” for more information.
<b>Ctrl</b> lights up briefly in the time display when a programme is selected.	The washer-dryer is indicating that it is networked.
<b>OFF</b> lights up in the time display when the <b>MobileStart</b>  programme is selected.	The remote control function is switched off. <ul style="list-style-type: none"> <li>■ Activate the remote control programmable function P97 to operate the washer-dryer via the app.</li> </ul>
<b>Con</b> lights up in the time display when the <b>MobileStart</b>  programme is selected.	The washer-dryer is networked and can be operated via the app.
<b>noC</b> lights up in the time display when the <b>MobileStart</b>  programme is selected.	Miele@home is not set up. <ul style="list-style-type: none"> <li>■ Network the washer-dryer; see “Before using for the first time – Setting up Miele@home”.</li> </ul>
<b>Err</b> lights up when switching on the washer-dryer.	There is a fault. <ul style="list-style-type: none"> <li>■ Switch the washer-dryer off.</li> <li>■ Switch the washer-dryer back on.</li> <li>■ If <b>Err</b> appears again, contact the Miele Customer Service Department.</li> </ul> <p>You can continue to use the washer-dryer.</p> <ul style="list-style-type: none"> <li>■ Touch the lit  sensor control.</li> </ul>



### General problems with the washer-dryer

Problem	Cause and remedy
<b>The display is dark.</b>	The display has switched off automatically to save energy (Standby mode). <ul style="list-style-type: none"> <li>■ Press a button. Standby comes to an end.</li> </ul>
<b>The washer-dryer is not steady during a spin cycle.</b>	The machine feet are not level. <ul style="list-style-type: none"> <li>■ Level the washer-dryer and secure the feet.</li> </ul>
<b>Unusual pumping noises.</b>	This is not a fault. These slurping noises occur at the end of the pump sequence as a normal part of operation.
<b>Spinning sounds during the drying process.</b>	This is not a fault. The machine will spin, even during a drying programme (thermospin).
<b>The laundry has not been spun properly and the laundry is still wet.</b>	The machine detected an imbalance during the final spin cycle and reduced the spin speed automatically. <ul style="list-style-type: none"> <li>■ Include both large and small items in the load as this will give better distribution during spinning.</li> </ul>
<b>Large amounts of detergent residue remain in the detergent drawer.</b>	The water flow pressure is too low. <ul style="list-style-type: none"> <li>■ Clean the filters in the water inlet.</li> <li>■ Select <i>Water plus</i>.</li> </ul>
	Powder detergent used in conjunction with water softeners tends to become sticky. <ul style="list-style-type: none"> <li>■ Clean the detergent drawer and, in the future, add washing powder in the compartment first, and then add the water softener.</li> </ul>

## Problem solving guide

---

### General problems with the washer-dryer

Problem	Cause and remedy
<b>Fabric conditioner is not completely dispensed or too much water remains in the  compartment.</b>	<p>The siphon tube is not correctly positioned or is clogged.</p> <ul style="list-style-type: none"><li>■ Clean the siphon, see “Cleaning and care - Cleaning the detergent dispenser drawer”.</li></ul>
<b>There is water in the fabric conditioner compartment next to the capsule.</b>	<p>CapDosing was not activated or an empty capsule was not removed at the end of the last wash programme.</p> <ul style="list-style-type: none"><li>■ Make sure that you remember to activate CapDosing the next time you insert a capsule.</li><li>■ Remove and dispose of the empty capsule at the end of each programme.</li></ul>
	<p>There is a blockage in the small pipe in the detergent drawer onto which the capsule is placed.</p> <ul style="list-style-type: none"><li>■ Clean the small pipe.</li></ul>
<b>At the end of the programme there is still liquid in the capsule.</b>	<p>The small pipe in the detergent dispenser drawer onto which the capsule is placed is blocked.</p> <ul style="list-style-type: none"><li>■ Clean the small pipe.</li></ul>
	<p>This is not a fault. For technical reasons a small amount of water will remain in the capsule.</p>
<b>The time left duration in the display fluctuates.</b>	<p>The countdown time adapts constantly to the current washing and drying process.</p>

### General problems with the washer-dryer

Problem	Cause and remedy
<p><b>Foam comes out of the detergent dispenser drawer while the <i>Rinse out fluff</i> programme is running.</b></p>	<p>Residual detergent from the last programme is still present in the suds container.</p> <ul style="list-style-type: none"> <li>■ Make sure you dispense the correct amount of detergent.</li> <li>■ Follow the dispensing recommendations on the packaging.</li> </ul>
<p><b>There is foam in the drum at the end of the <i>Rinse out fluff</i> programme.</b></p>	<p>The <i>Rinse out fluff programme</i> also rinses out residual detergent from the suds container. This can lead to the formation of foam.</p> <ul style="list-style-type: none"> <li>■ Run the <i>Rinse out fluff</i> programme regularly to prevent detergent residues from accumulating in the suds container.</li> </ul>
<p><b>There is still fluff in the drum after the end of the <i>Rinse out fluff</i> programme.</b></p>	<p>You have not run the <i>Rinse out fluff</i> programme for a long time.</p> <ul style="list-style-type: none"> <li>■ Remove the fluff from the drum.</li> <li>■ Run the <i>Rinse out fluff</i> programme on a regular basis.</li> </ul>
<p><b>The washer-dryer smells.</b></p>	<p>The <b>i</b> indicator light was ignored. A wash programme using a temperature above 60 °C has not been run for a long time.</p> <ul style="list-style-type: none"> <li>■ In order to prevent bacteria and unpleasant odours building up in the washer-dryer, run the <i>Cottons 90 °C</i> programme using the Miele machine cleaner or multi-purpose powder detergent.</li> </ul>
	<p>The door and the detergent drawer were closed after washing.</p> <ul style="list-style-type: none"> <li>■ Leave the door and the detergent drawer slightly open to allow them to dry.</li> </ul>

## Problem solving guide

---

### An unsatisfactory wash result

Problem	Cause and remedy
<b>White residues which look like powder detergent are seen on dark textiles after washing.</b>	<p>The detergent contained compounds (zeolites) to aid water softening which are not soluble in water. These have ended up on the laundry.</p> <ul style="list-style-type: none"><li>■ Try and brush off the residues with a soft brush once the laundry is dry.</li><li>■ Wash dark textiles using a detergent which contains no zeolites. Liquid detergents usually contain no zeolites.</li><li>■ Use the <i>Dark garments</i> programme.</li></ul>
<b>Liquid detergent does not give the required result.</b>	<p>Liquid detergents usually contain no bleaching agents. They do not remove fruit, coffee and tea stains.</p> <ul style="list-style-type: none"><li>■ Use a general purpose powder detergent containing a bleaching agent.</li><li>■ Pour stain remover into compartment  and liquid detergent into a dispensing ball (<b>remove the dispensing ball before drying!</b>).</li><li>■ Never put stain removers and liquid detergent together in the dispenser drawer.</li></ul>
<b>Grey, greasy particles cling to washed laundry.</b>	<p>Insufficient amounts of detergent were used to break down the particles of grease in heavily soiled laundry.</p> <ul style="list-style-type: none"><li>■ Use more detergent.</li><li>■ Before washing the next load, run the <i>Maintenance wash</i> using Miele machine cleaner or a powder detergent.</li></ul>

## Unsatisfactory drying results

Problem	Cause and remedy
<p><b>The laundry is too damp after a drying cycle.</b></p>	<p>The load is too small. The electronics could not assess the residual moisture correctly.</p> <ul style="list-style-type: none"> <li>■ In the future, use a <i>Warm air</i> programme for small amounts of laundry.</li> </ul> <p>During the spin cycle, the laundry formed a ring in the drum because the laundry was distributed unevenly. The laundry formed a ring during the thermospin because it was too damp or because the spin speed was set too high.</p> <ul style="list-style-type: none"> <li>■ Open the door and loosen the laundry.</li> <li>■ Start the drying programme again with a lower spin speed.</li> </ul>
<p><b>The laundry feels damp after drying.</b></p>	<p>Warm laundry can feel damp.</p> <ul style="list-style-type: none"> <li>■ Spread the laundry out to cool it down.</li> </ul>
<p><b>The laundry is too damp or too dry after a drying cycle.</b></p>	<p>The desired residual moisture level is between two drying stages.</p> <ul style="list-style-type: none"> <li>■ Change the level of drying as described in “Settings”, “Drying levels”.</li> </ul>
<p><b>There is still water in the drum after drying.</b></p>	<p>There is a blockage in the water outlet.</p> <ul style="list-style-type: none"> <li>■ Clean the drain filters and the drain pumps as described in “Opening the door in the event of a blocked drain outlet and/or power failure” and check the height of the drainage point.</li> </ul>

## Problem solving guide

---

### The door will not open

Problem	Cause and remedy
<b>The door cannot be opened during a programme sequence.</b>	The door is locked during a programme sequence. ■ Follow the instructions in “Changing the programme sequence – Adding laundry”.
	There is still water in the drum and the washer-dryer is unable to drain. ■ Clean the drain filter and the drain pump as described in “Opening the door in the event of a blocked drain outlet and/or power cut”.
	The water level in the drum is too high. ■ Cancel the programme. The washer-dryer will pump the water away.
<b>The door cannot be opened at the end of the programme or after a programme cancellation. Flashing bars [ ]...[ ]...[ ]... are shown on the time display.</b>	The door cannot be opened for safety reasons. The temperature in the drum exceeds 55 °C during washing or 70 °C during drying. ■ Wait until the temperature in the drum has decreased and the door will be unlocked.
<b>The door will not unlock. F and 35 alternate on the time display.</b>	The door lock has jammed. ■ Call the Miele Customer Service Department.

## Opening the door in the event of a blocked drain outlet and/or power cut

- Switch the washer-dryer off.

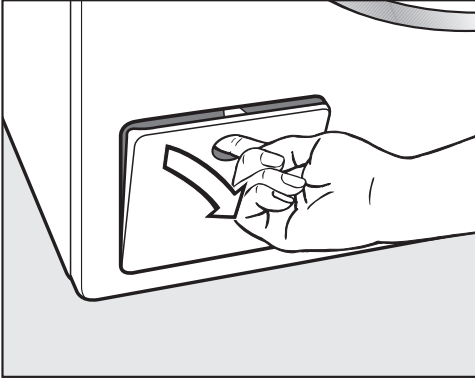

- Open the drain pump access panel.

### Blocked drain outlet

If the drain outlet is blocked, a large quantity of water can remain in the washer-dryer.

**⚠ Risk of scalding due to hot suds.**  
Escaping suds will be hot if laundry has been washed at high temperatures.  
Carefully allow all suds to drain off.

## Draining water from the machine

Remove the drain filter, though not completely.

- Place a suitable container under the access panel, e.g. a universal oven tray.

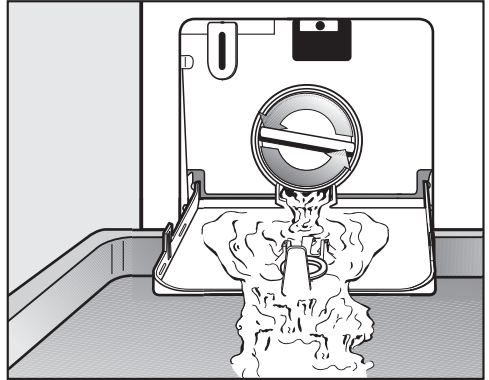

- Slowly unscrew the drain filter to let the water out.
- Tighten the drain filter back up again if you need to interrupt the flow of water.

Once the flow of water ceases:

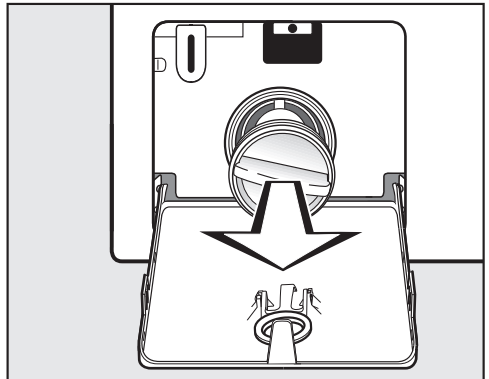

- Remove the drain filter completely.

# Problem solving guide

## Cleaning the drain filter

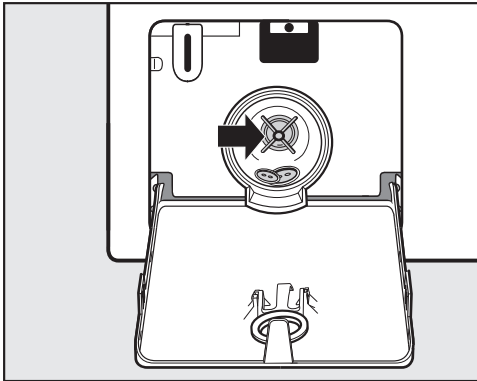

- Clean the drain filter thoroughly.
- Turn the impellers by hand to check that they rotate freely.
- Remove any foreign objects (e.g. buttons, coins, etc.) and clean the interior.
- Put the drain filter back in place and secure it.

 Risk of damage from leaking water.

Water will escape from the washer-dryer if you forget to replace the drain filter.

Replace the drain filter correctly and tighten it securely.

## Open the door

 Danger of injury due to rotating drum.

Reaching into a moving drum is extremely dangerous.

Always make sure that the drum is stationary before reaching in to remove laundry.

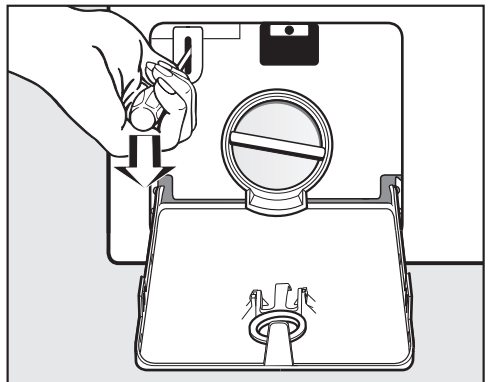

- Unlock the door with a screwdriver, for example.
- Pull open the door.



Information to help you rectify faults yourself and about Miele spare parts can be found at [www.miele.com/service](http://www.miele.com/service).

## Contact in the event of a fault

In the event of any faults which you cannot remedy yourself, please contact your Miele dealer or the Miele Customer Service Department.

You can book a Miele Customer Service Department call-out online at [www.miele.com/service](http://www.miele.com/service).

Contact information for the Miele Customer Service Department can be found at the end of this document.

Please quote the model identifier and serial number of your appliance (Fabr./SN/Nr.) when contacting the Miele Customer Service Department. This information can be found on the data plate.

Please note that telephone calls may be monitored and recorded for training purposes and that a call-out charge will be applied to service visits where the problem could have been resolved as described in this booklet.

The data plate is found above the porthole glass when the door is opened.

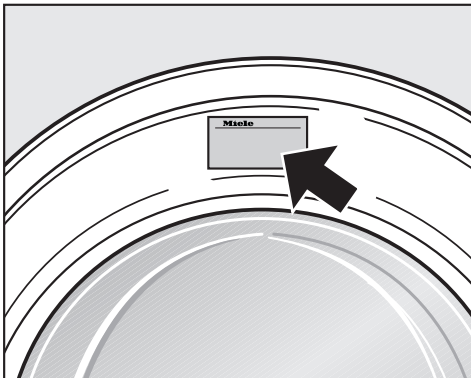

## Warranty

For information on the appliance warranty specific to your country please contact Miele. See back cover for address.

In the UK, your appliance warranty is valid for 2 years from the date of purchase. However, you must activate your cover by calling 0330 160 6640 or registering online at [www.miele.co.uk](http://www.miele.co.uk).

## Optional accessories

Optional accessories for this washer-dryer are available from Miele or your Miele dealer.

## EPREL database

From 1 March 2021, information on energy labelling and ecodesign requirements will be available in the European Product Database (EPREL). You can find the product database at the following link <https://eprel.ec.europa.eu/>. You will be asked to enter the model identifier.

The model identifier can be found on the data plate.

**Miele** Made in xxx

Mod.: **XXXxxx**

M-Nr.: xxxxxxxx Type: XXxx-X

Nr.:/ xxxxxxxx

**Miele Service**

[www.miele.com/service](http://www.miele.com/service)

# Installation

## Front view

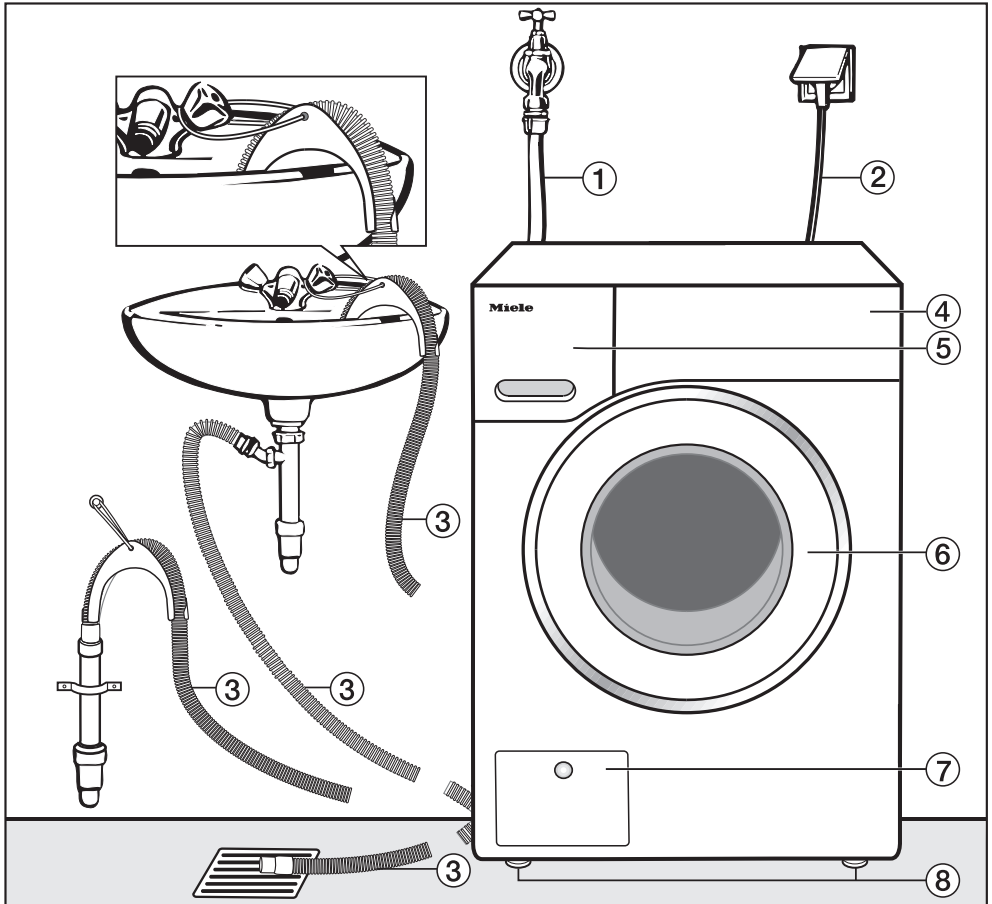

- ① Water inlet hose
- ② Electrical connection
- ③ Flexible drain hose (with detachable elbow)
- ④ Control panel
- ⑤ Detergent drawer
- ⑥ Door
- ⑦ Access to drain filter, drain pump and emergency release
- ⑧ 4 height-adjustable feet

## Rear view

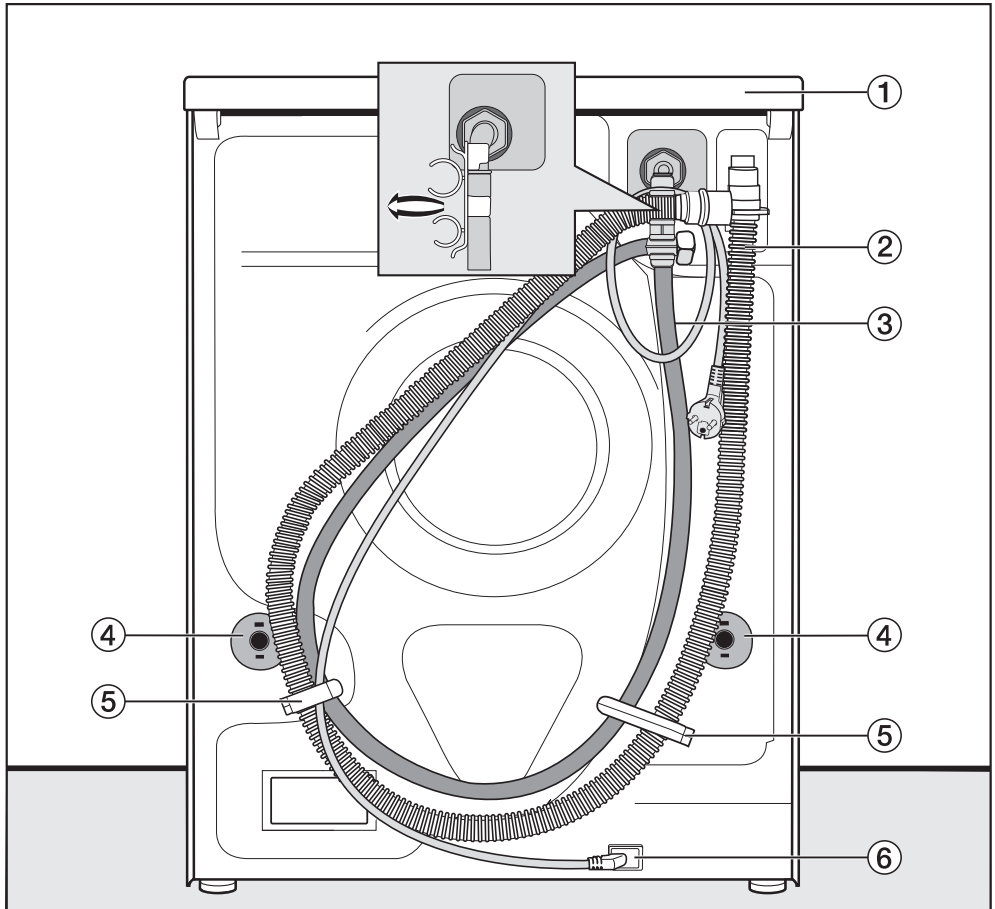

- ① Protruding lid for holding when moving the appliance
- ② Drain hose
- ③ Water inlet hose
- ④ Safety caps for transit bars
- ⑤ Transport clips for water inlet hoses and drain hoses
- ⑥ Electrical connection

# Installation

## Installation surface

A concrete floor is the most suitable installation surface. It is far less prone to vibration during the spin cycle than wooden floorboards or a carpeted surface.

Please note:

- The washer-dryer must be level and securely positioned.
- To avoid vibrations during spinning, the washer-dryer must not be installed on soft floor coverings.

If installing on a wooden joist floor, please note:

- Use a plywood base underneath the washer-dryer (at least 59 x 52 x 3 cm). The base must span several joists and be bolted to the joists and not only to the floorboards.

**Tip:** If possible, install the washer-dryer in a corner of the room, as this is usually the most stable part of the floor.

**⚠** Danger of injury due to unsecured washer-dryer.

If the washer-dryer is installed on an existing on-site plinth (concrete or brick), there is a danger of the machine falling off the plinth during the spin cycle.

Secure the washer-dryer with a fastening bracket (optional accessory).

## Carrying the washer-dryer to its installation site

**⚠** Danger of injury due to unsecured lid.

The fixings at the back of the lid could break as a result of external forces. There is a danger of the lid being pulled off when carrying the machine.

Before carrying the machine, check that the lid is secure where it protrudes at the back of the machine.

- Carry the washer-dryer by the front feet and by the lid where it protrudes at the back of the machine.

## Removing the transit bars

### Removing the left-hand transit bar

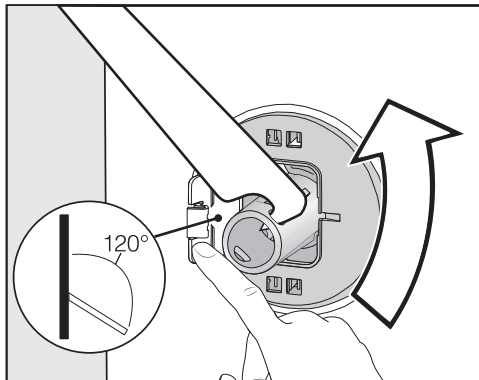

- Push the cover out and turn the left-hand transit bar 90° using the open spanner supplied.

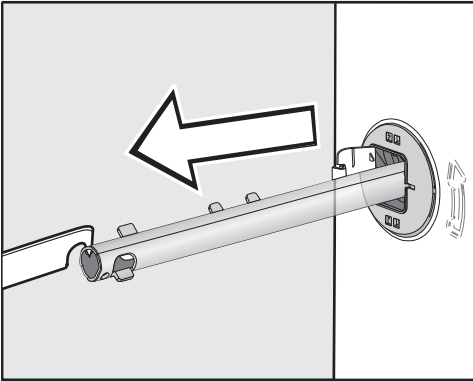

- Pull out the transit bar.

## Removing the right-hand transit bar

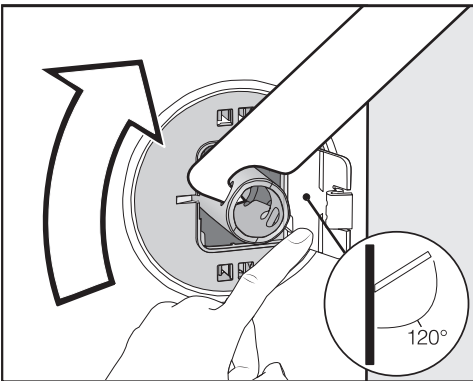

- Push the cover out and turn the left-hand transit bar 90° using the open spanner supplied.

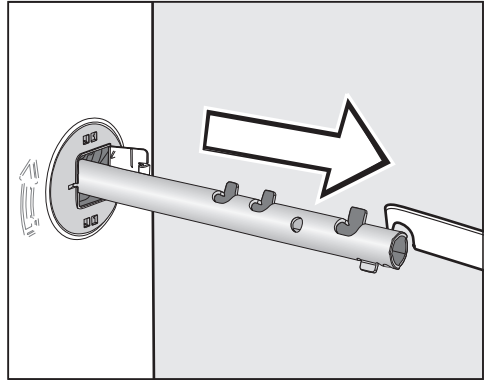

- Pull out the transit bar.

## Covering holes

⚠ Danger of injury from sharp edges.

There is a danger of injury from reaching into holes that are not covered.

Cover the holes for the transit bars after they have been removed.

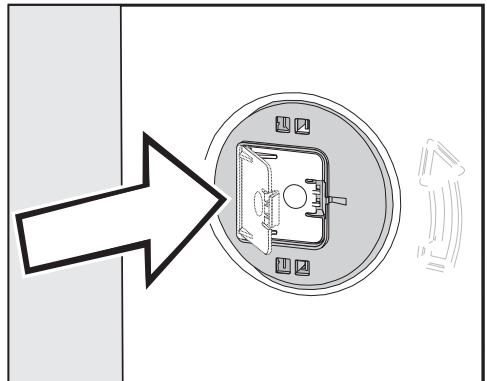

- Push the covers in firmly until they engage in position.

# Installation

## Refitting the transit bars

 Risk of damage from incorrect transport.

The washer-dryer may become damaged if moved without the transit bars in place.

Keep the transit bars in a safe place. Fit them again if the washer-dryer is to be moved (e.g. when moving house).

## Opening the covers

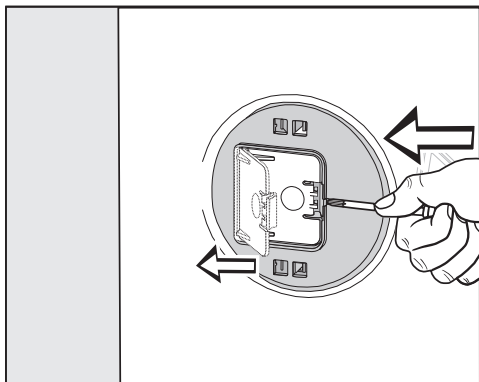

- Press against the retainer with a sharp object (a narrow screwdriver, for example).

The cover will open.

## Fitting the transit bars

- To fit the bars, follow the instructions for removing them in reverse order.

**Tip:** The bars will slide in more easily if you lift the drum slightly.

## Installing under a worktop

Building under kits\* must only be installed/dismantled by a specialist.

- A special **building under kit\*** is required. The cover plate included in the building under kit\* replaces the lid of the washer-dryer. It is necessary to fit the cover plate for electrical safety reasons.
- Connections for electricity, water and drainage should be installed in such a way that they remain accessible when the washer-dryer is in its final position.

The building under kit includes installation instructions.

\* Optional accessories

## Aligning the washer-dryer

The washer-dryer must stand perfectly level on all four feet to ensure safe and proper operation.

Incorrect installation may increase electricity and water consumption and may cause the washer-dryer to move about.

## Screwing out and adjusting the feet

The 4 adjustable feet are used to level the washer-dryer. The appliance is supplied with all feet screwed in.

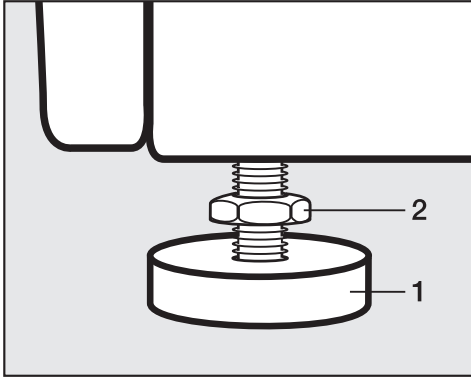

- Using the open spanner supplied, turn counter nut **2** in a clockwise direction. Then turn counter nut **2** together with foot **1** to unscrew.

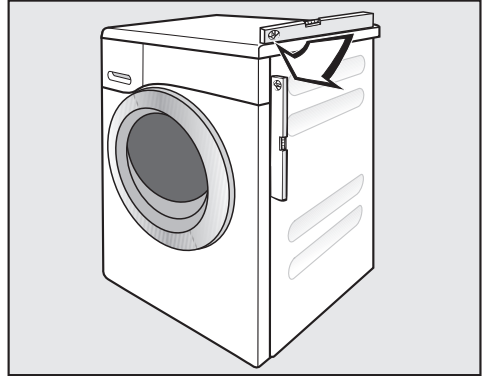

- Use a spirit level to check the washer-dryer is standing level.
- Hold foot **1** securely with a pipe wrench. Turn counter nut **2** again using the open spanner supplied until it sits firmly up against the casing.

 Risk of damage from incorrectly aligned washer-dryer.

There is a danger of the washer-dryer moving about if the feet are not secured.

Turn all 4 counter nuts for the feet until they sit firmly up against the casing. Please also check this for the feet which did not need adjustment.

# Installation

## The water protection system

The Miele water protection system protects all parts of the washer-dryer from water damage.

The system mainly consists of the following components:

- the inlet hose
- the electronic unit and drainage and overflow protection
- the drain hose

### Inlet hose

- Protected from bursting

The inlet hose can withstand pressure of more than 7000 kPa.

### Electronic unit and casing

- The floor tray

Any leaking water is collected in a floor tray in the base of the washer-dryer. A float switches off the water inlet valves. Further water intake is blocked. The water inside the suds container is pumped down.

- Overflow protection

This prevents the washer-dryer from taking in too much water and overflowing. If the water level exceeds a certain level, the drain pump switches on and pumps the excess water away.

### Drain hose

The drain hose is protected by a ventilation system which prevents the washer-dryer from being emptied completely.

## Water intake

 Health risk and risk of damage due to contaminated incoming water. The quality of the incoming water must correspond to the drinking water specification of the country in which the machine is being operated. Always connect the washing machine to the mains water supply.

The washer-dryer is not required to have a non-return valve connected to the mains water supply as the washing machine has been designed to comply with DIN regulations in Germany.

The water inlet pressure must be at least 100 kPa and must not exceed an overpressure of 1000 kPa. If the pressure exceeds 1000 kPa, a pressure reducing valve must be installed.

Connection to the mains water supply should incorporate a stopcock with a  $\frac{3}{4}$ " screw thread. If no stopcock is available, only a qualified installer may connect the washer-dryer to the mains water supply.

The connection point is subject to mains water pressure. You should open the stopcock slowly and check for leaks. Correct the position of the seal and screw thread if water escapes.

The washer-dryer is **not** suitable for connection to a hot water supply.

## Maintenance

Only use a genuine Miele hose that has been pressure tested to withstand at least 14,000 kPa should you ever need a replacement.



The dirt filter in the union nut at the open end of the water protects the water intake valve.

This filter must not be removed.

## **Hose extension**

A 1.5 metre long metal extension hose is available from Miele as an optional accessory.

## **Maintenance**

Only use a genuine Miele hose that has been pressure tested to withstand at least 7000 kPa should you ever need a replacement.

The dirt filter in the union nut at the open end of the water inlet hose protects the water intake valve.

This filter must not be removed.

## **Hose extension**

Longer hoses 2.5 or 4.0 m in length are available from Miele as optional extras.

# Installation

## Water drainage

The suds are drained through a drain pump with a 1 m delivery head. For the water to drain freely, the hose must be free of kinks. The elbow piece supplied hooks onto the end of the hose. If required, the hose can be extended to a length of up to 5 m. Accessories are available from Miele or from your Miele dealer.

For a delivery head of more than 1 m (up to a max. of 1.8 m) a replacement drain pump will need to be fitted. Please contact Miele for advice. With a delivery head in excess of 1 m the hose can be extended to a maximum of 2.5 m. Accessories are available from Miele or from your Miele dealer.

### Drainage options:

#### 1. Directed into a sink or basin:

Please note:

- Hook the hose over the edge and secure it.
- If the water is pumped into a washbasin, make sure that it can drain away freely. Otherwise there is a risk of water overflowing or of some of the drained water being sucked back into the machine.

#### 2. Connected securely to a plastic drain pipe with a rubber nipple (there is no need to use a siphon).

#### 3. Connected securely to a floor drain (gully).

#### 4. Connected securely to a washbasin with a plastic nipple.

### Connected securely to a washbasin

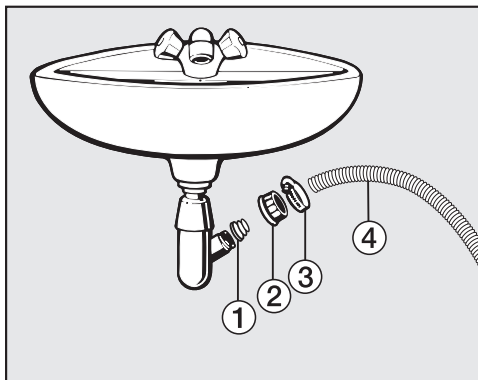

- ① Adapter
- ② Spigot nut
- ③ Hose clip
- ④ End of the hose

■ Fit adapter ① to the sink drain outlet using nut ②.

■ Attach the end of hose ④ to adapter ①.

■ Use a screwdriver to tighten hose clip ③ up close to the nut.

## Electrical connection

The washer-dryer is supplied with a mains cable with moulded plug ready for connection to a suitable earthed socket.

The socket must be easily accessible after the washer-dryer has been installed. If that is not possible, ensure that a suitable means of disconnection is provided on the installation side for each pole.

 Risk of fire from overheating. Connecting the washer-dryer to a multi-socket adapter or to an extension lead can overload the cable. For safety reasons, do not use an extension lead or multi-socket adapter.

The electrical system must comply with local and national safety regulations (BS 7671 in the UK). We recommend the use of a suitable RCD .

If the mains connection cable is damaged, it must only be replaced with a specific mains connection cable of the same type (available from the Miele Customer Service Department). For safety reasons, such replacement may only be carried out by a qualified technician or the Miele Customer Service Department.

These operating instructions and the data plate indicate the nominal power consumption and the appropriate fuse rating. Compare this information with the data of the on-site electrical connection.

If in any doubt, consult a qualified electrician.

Temporary or permanent operation on an autonomous power supply system or a power supply system that is not synchronised with the mains power supply (e.g. island networks, back-up systems) is possible. A prerequisite for operation is that the power supply system complies with the specifications of EN 50160 or an equivalent standard. The function and operation of the protective measures provided in the domestic electrical installation and in this Miele product must also be maintained in isolated operation or in operation that is not synchronised with the mains power supply, or these measures must be replaced by equivalent measures in the installation. As described, for example, in the current version of BS OH-SAS 18001–2 ISO 45001.

# Garment care label symbols

Washing	
The figure quoted in the bucket is the maximum temperature at which the garment can be washed.	
	Normal agitation
	Reduced agitation
	Much reduced agitation
	Hand wash
	Do not wash

## Programme selection examples

Programme	Care symbols
ECO 40–60	
Cottons	
Minimum iron	
Delicates	
Woollens	

Drying	
	Normal temperature
	Low temperature
	Do not tumble dry

Ironing	
	Approx. 200 °C
	Approx. 150 °C
	Approx. 110 °C
	Ironing with steam can cause irreversible damage.
	Ironing/rotary ironing prohibited

Professional cleaning	
	Dry clean only. The letters indicate the type of cleaning agent required.
	Wet cleaning
	Dry cleaning prohibited

Bleaching	
	Any oxidation bleach can be used
	Use oxygen bleach only
	Do not bleach

## Technical data

Height	850 mm
Width	596 mm
Depth	637 mm
Depth with door open	1055 mm
Weight	Approx. 95 kg
Capacity, washing	8.0 kg dry laundry
Capacity, drying	5.0 kg dry laundry
Supply voltage	See data plate
Rated load	See data plate
Fuse rating	See data plate
Consumption data	See “Consumption data”
Minimum water flow pressure	100 kPa (1 bar)
Maximum water flow pressure	1000 kPa (10 bar)
Water inlet hose length	1.55 m
Drain hose length	1.50 m
Connection cable length	2.00 m
Maximum delivery head	1.00 m
Maximum drainage length	5.00 m
LEDs	Class 1
Test certifications awarded	See data plate
Power rating in off mode	0.30
Networked standby	0.70
Frequency band of the WiFi module	2.4000 GHz – 2.4835 GHz
Maximum transmitting power of the WiFi module	< 100 mW

# Technical data

---

## EU Conformity declaration

Miele hereby declares that this washing machine complies with Directive 2014/53/EU.

The complete text of the EU declaration of conformity is available from one of the following internet addresses:

- Products, Download from [www.miele.ie](http://www.miele.ie)
- For service, information, operating instructions etc: go to <https://miele.co.uk/manuals> and enter the name of the product or the serial number

## UK Conformity declaration

Miele hereby declares that this washing machine complies with UK Radio Equipment Regulations 2017, as amended.

The complete text of the UK declaration of conformity is available from one of the following internet addresses:

- Products, Download from [www.miele.co.uk](http://www.miele.co.uk)
- For service, information, operating instructions etc: go to <https://miele.co.uk/manuals> and enter the name of the product or the serial number

This **Statement of Compliance** confirms this Miele product fully complies with the **Product Security and Telecommunications Infrastructure (Security Requirements for Relevant Connectable Products) Regulations 2023**.

- 1) Household Appliance – *Washer-Dryer HWT04-W*
- 2) Manufactured by: Miele & Cie KG,  
Carl Miele Street 29, 33332 Gutersloh Germany  
Imported by and contact point: Miele Company Ltd, Fairacres, Marcham Road,  
Abingdon, Oxon, OX14 ITW Great Britain
- 3) The defined support period at the time of first supply is 10 years
- 4) To report vulnerabilities and cybersecurity issues please contact: [psirt@miele.com](mailto:psirt@miele.com)
- 5) Signature 

Name: **Paul Wright**

Company Position: **Head of Technical Management**

Date of signature: **19th March 2024**

Place of signature: **Abingdon, Oxfordshire**

Programmes	Load kg	Energy kWh	Water Litres	Programme running time h:min	Temperature <sup>1</sup> °C	Residual moisture %	Spin speed rpm
<b>Washing</b>							
ECO 40-60*	8.0	0.77	60	3:39	43	47	1500
	4.0	0.42	52	2:48	32	47	1500
	2.0	0.18	28	2:48	25	49	1500
Cottons	8.0	1.35	57	2:29	54	51	1500
	20 <sup>2</sup>	0.35	72	2:39	20	51	1500
Minimum iron	3.5	0.32	47	1:59	30	30	1200
Express <sup>3</sup>	4.0	0.33	30	0:20	27	60	1200
Woolens	3.0	0.23	35	0:39	–	–	–
<b>Washing and drying</b>							
ECO 40-60* Normal	5.0	3.30	85	6:29	35	0	1500
	2.5	1.60	43	3:59	28	0	1500

\* Test programme for compliance with EU legislation regarding ecodesign 2019/2023 and energy labelling in accordance with Regulation No. 2019/2014

<sup>1</sup> Maximum laundry temperature reached in main wash.

<sup>2</sup> 20 °C programme for lightly soiled cotton garments.

<sup>3</sup> *Short* extra option activated

## Information for customers

Consumption data can vary from the nominal values given depending on water pressure, water hardness, water inlet temperature, room temperature, type and volume of load, fluctuations in the mains voltage and any extra options selected.

# Programmable functions

The programmable functions are used to alter the washer-dryer's electronics to suit changing requirements. Programmable functions can be altered at any time.

Programming is carried out in 9 steps (1, 2, 3 ... 9) using the sensor controls.

## Opening the programming level

Prerequisites:

- The washer-dryer is switched on and the programme selector is pointing to a programme.
- The door of the washer-dryer is open.

- 1 Touch the *Start/Add laundry* sensor control and hold it down whilst carrying out steps 2–3.
- 2 Close the washer-dryer door.
- 3 Wait until the *Start/Add laundry* sensor control lights up constantly ...
- 4 ... and then release the *Start/Add laundry* sensor control.

After a few seconds, *P13*, for example, will light up on the time display.

## Choosing and selecting a programmable function

The number of the programmable function will appear on the time display as *P* and a number: e.g. *P13*.

- 5 Touch the < or > sensor control to scroll to the next or previous programmable function:

## Programmable functions

<i>P11</i>	Buzzer duration
<i>P12</i>	Buzzer
<i>P13</i>	Keypad tone
<i>P14</i>	PIN code
<i>P22</i>	Control field switch-off behaviour
<i>P24</i>	Memory
<i>P28</i>	Gentle action
<i>P29</i>	Temperature reduction
<i>P32</i>	Maximum rinse level
<i>P33</i>	Suds cooling
<i>P49</i>	Low water pressure
<i>P62</i>	Display brightness
<i>P70</i>	Cottons drying level
<i>P71</i>	Minimum iron drying level
<i>P72</i>	Extended cool down
<i>P77</i>	Laundry ring prevention
<i>P90</i>	Operating hours
<i>P97</i>	Remote control
<i>P98</i>	SmartGrid
<i>P99</i>	RemoteUpdate
<i>P00</i>	Factory default

- 6 Confirm the selected programmable function by touching the *Start/Add laundry* sensor control.



# Programmable functions

## Editing and saving a programmable function

You can switch a programmable function on/off or select different options.

- Touch the < or > sensor control to switch a programmable function on/off or to select an option.

Programmable function	Available options					
	-00	-01	-02	-03	-04	-05 to -07
P11		•	•			
P12	•	•	•			
P13	•	•	•			
P14	•	•				
P22	•	•				
P24	•	•				
P28	•	•				
P29	•	•				
P32	•	•				
P33	•	•				
P49	•	•				
P62		•	•	•	•	•
P70		•	•	•	•	•
P71		•	•	•	•	•
P72	•	•	•	•	•	-05 to -08
P77	•	•	•	•	•	
P97	•	•				
P98	•	•				
P99	•	•				
P00	•	•				

- Confirm the chosen selection with the *Start/Add laundry* sensor control.

The number of the programmable function, e.g. P13, will then light up again.

## Exiting the programming level

- Turn the programme selector to the  position.

The settings you have selected are now stored in the memory. You can alter the settings again at any time.

## P11 Buzzer duration

The buzzer sounds to let you know the programme has finished. You can decide how long the buzzer should sound for.

### Options

- 01 = The buzzer sounds 3 times at the end of the programme.
- 02 = The buzzer sounds until the washer-dryer switches off automatically (max. 1 hour).

## P12 Buzzer

The buzzer sounds to let you know the programme has finished.

### Options

- 00 = Off
- 01 = On – quiet
- 02 = On – loud

## Programmable functions

### P13 Keypad tone

The buzzer that sounds when a sensor control is pressed can be switched on or off.

#### Options

- 00 = Off
- 01 = On – quiet
- 02 = On – loud

### P14 PIN code

The PIN code prevents your washer-dryer being used without your knowledge.

When the PIN code has been activated, you have to enter the code after switching the washer-dryer on. Otherwise the washer-dryer cannot be operated.

#### Options

- 00 = Off
- 01 = On

If the -01 option has been selected, you will have to enter the PIN code before you can operate the washer-dryer.

#### Using the washer-dryer when the PIN code is activated

The code is **125** and cannot be altered.

- Switch the washer-dryer on.

0 \_\_ appears on the time display and the > and < sensor controls light up.

- Touch the > sensor control.

1 \_\_ appears on the time display.

- Confirm the number with the *Start/Add laundry* sensor control.

The first number has been saved.

- Enter the second and third numbers using the > and < sensor controls and confirm the numbers with the *Start/Add laundry* sensor control.

The lock function is deactivated.

### P22 Control field switch-off behaviour

To save energy the time display and sensor controls will go out after 10 minutes, and only the *Start/Stop* sensor control will flash slowly.

#### Options

- 00 = Off  
The time display and sensor controls will remain lit up while the washer-dryer is switched on.
- 01 = On  
The time display and sensor controls will switch off 10 minutes after the programme has started.

However, the time display and sensor controls will remain lit up for 10 minutes after a delay start period has elapsed, after the end of a programme or at the end of the anti-crease phase.

## P24 Memory

The washer-dryer will save the last settings selected for a programme (temperature, spin speed) after the programme has started.

The next time that programme is used the washer-dryer will show those settings in the display.

### Options

-00 = Off

-01 = On

## P28 Gentle action

With gentle action activated, drum agitation is reduced. In this way, lightly soiled items can be washed more gently.

Gentle action can be activated for the *Cottons* and the *Minimum iron* wash programmes.

### Options

-00 = Off

-01 = On

## P29 Temperature reduction

At high altitudes, water has a lower boiling point. Miele recommends activating the reduced temperature setting at altitudes of 2000 m or above to prevent water from boiling.

### Options

-00 = Off

-01 = On

## P32 Maximum rinse level

The water level in the rinses can be permanently set to the highest value in the *Cottons* and *Minimum iron* programmes.

This function is important for allergy sufferers as it achieves excellent rinse results. The water consumption will be increased.

### Options

-00 = Off

-01 = On

## P33 Suds cooling

Additional water flows into the drum at the end of the main wash to cool the suds down.

Suds cooling takes place when a *Cottons* programme with a temperature of 70 °C or higher is selected.

Suds cooling should be activated under the following circumstances:

- To prevent the danger of scalding if the drain hose is hooked over the edge of a sink or slops basin
- In buildings where the drainage pipes do not comply with DIN 1986

### Options

-00 = Off

-01 = On

## Programmable functions

---

### P49 Low water pressure

If the water pressure is below 100 kPa (1 bar), the programme will be cancelled. If the on-site water pressure cannot be increased, activating the setting will prevent the programme from being cancelled prematurely.

#### Options

-00 = Off

-01 = On

### P62 Display brightness

The brightness of the dimmed sensor controls in the control field can be set to one of 7 different levels.

The brightness changes as soon as you select a different setting.

#### Options

-01 = Darkest level



-07 = Brightest level

### P70 Cottons drying levels

You can adjust the drying levels for the Cottons programme if needed.

#### Options

-01 = Damper



-07 = Drier

### P71 Minimum iron drying levels

You can adjust the drying levels for the Minimum iron programme if needed.

#### Options

-01 = Damper



-07 = Drier

### P72 Extended cool down

The cooling phase which takes place before the end of a programme can be extended if required. This cools the garments down even more. The cooling phase can only be extended if a drying level has been selected. Extended cool down is not active for timed drying.

#### Options

-00 = Minutes



-18 = Minutes

### P77 Laundry ring prevention

The maximum final spin speed can be limited to prevent laundry forming a ring around the drum.

The *Laundry ring prevention* setting is only effective with continuous washing and drying.

#### Options

-00 = Off

-01 = 1200 rpm

-02 = 1100 rpm

-03 = 1000 rpm

-04 = 900 rpm

## P90 Operating hours

You can read off how many hours your washer-dryer has been in operation for.

The total operating time is shown on the time display in single digits. The washer-dryer has been in operation for 1234 hours, for example. The figure shown on the time display will start with an *H* followed by a *1*, then a *2* and after this a *3* and a *4*. The letter *H* is displayed again after this.

## P97 Remote control

You can use the Miele app to check the status of your washer-dryer from anywhere and start it remotely. You can also control it remotely via the *MobileStart* programme.

You can switch off the *P97* programmable function if you do not want to operate the washer-dryer with your mobile device.

If the *P97* programmable function is not switched on, the app can still be used to cancel a programme.

Use the  sensor control to set a time period within which you want to start the washer-dryer and start the delay start function (see “Delay start/SmartStart”). The washer-dryer will then start within the specified time-frame when it receives your signal. If it has not received a start signal by the latest start time set, the washer-dryer will start automatically.

### Options

-00 = Off

-01 = On

## P98 SmartGrid

You can set your washer-dryer to start automatically based on an external signal within a certain time period.

If you have activated *SmartGrid*, the  sensor control will have the new *SmartStart* function rather than the *Delay start* function.

Use the  sensor control to set a SmartStart time period. The washer-dryer will then start within the time period specified by you when it receives an external signal. If an external signal has not been received by the latest start time set, the washer-dryer will start automatically (see “Delay start/SmartStart”).

### Options

-00 = Off

-01 = On

# Programmable functions

## PPP RemoteUpdate

The RemoteUpdate function is used for updating the software in your washer-dryer. If an update is available for your washer-dryer, it will automatically download it. Updates will not be installed automatically. They must be initiated manually.

If you do not install an update, you can continue to use your washer-dryer in the usual way. However, Miele recommends installing updates.

### RemoteUpdate procedure

Information about the content and scope of an update will be provided in the Miele app.

A *UP* message will appear on the time display if an update is available.

You can install the update immediately or postpone this until later. When the washer-dryer is switched on again, you will be reminded about the update.

The update may take several minutes.

Please note the following about the RemoteUpdate function:

- You will only receive a message when an update is available.
- Once an update has been installed, it cannot be undone.
- Do not switch off the washer-dryer during an update. Otherwise, the update will be aborted and will not be installed.
- Some updates can only be carried out by the Miele Customer Service Department.

## Activating/deactivating

The *RemoteUpdate* function is activated as standard. A new update will be downloaded automatically but will only be installed if you initiate installation manually. Deactivate the *RemoteUpdate* function if you do not want any updates to be downloaded automatically.

### Options

-00 = Off

-01 = On

### Starting the update

After the washer-dryer is switched on, *UP* appears on the time display.

- Touch the *Start/Add laundry* sensor control.

*UP* will flash on the time display. The update starts.

Bars on the time display show the progress of the update:

I = 0 %

||||| = 100 %

### Postponing the update

After the washer-dryer is switched on, *UP* appears on the time display.

- Touch the  sensor control.

The running time of the selected programme appears on the time display.

The next time you switch on the appliance, you will be prompted to start the update again.

## P00 Factory default

All programmable functions except P90 operating hours are reset to the factory default settings.



### Options

- 00 = Go back (without reset to factory default settings)
- 01 = Reset programmable functions to the factory default settings

## Switching off WiFi

- Turn the programme selector to the *MobileStart* programme.

☞ appears on the time display.

- Press the  sensor control and hold the  sensor control until the countdown on the time display has finished.

--- appears on the time display.

- The WiFi is switched off.
- The WiFi connection will be reset to the factory default setting.

The network configuration should be reset whenever a washer-dryer is being disposed of or sold, or if a used washer-dryer is being put into operation. This is the only way to ensure that all personal data has been removed and the previous owner will no longer be able to access the washer-dryer.

A new connection setup has to be carried out in order to use Miele@home again.

## Copyrights and licences for the communication module

For the purpose of operating and controlling the communication module, Miele uses proprietary or third-party software that is not covered by open source licensing terms. These items of software/software components are protected by copyright. The copyrights held by Miele and third parties must be respected.

Furthermore, this communication module contains software components which are distributed under open source licence conditions. The open source components contained in the appliance along with the corresponding copyright notices, copies of the licensing terms valid at the time, and any further information can be accessed locally via IP using a web browser (<http://<IP address>/Licenses>). The liability and warranty arrangements for the open source licences displayed in this location only apply in relation to the respective rights holders.

## Detergents and care products

---

Detergent, fabric care products, additives and machine care products are available for this washing machine. All products have been designed for Miele washing machines.

These and many other products can be ordered from [www.shop.miele.com](http://www.shop.miele.com), the Miele Customer Service Department or your Miele dealer.

### Detergent

#### **UltraWhite (powder detergent)**

- Best results at 20/30/40/60/95 °C
- Radiant white laundry thanks to powerful formula with active oxygen
- Excellent stain removal even at low temperatures

#### **UltraColor (liquid detergent)**

- Best wash results at 20/30/40/60 °C
- With colour-protection formula for brilliant colours
- Excellent stain removal even at low temperatures

#### **WoolCare delicates detergent (liquid detergent)**

- For wool, silks and delicates
- Special care complex based on wheat protein and with colour-protection formula
- Best wash results at 20/30/40/60 °C



## Specialist detergents

These specialist detergents are available as convenient single-use capsules.

### Caps Sport

- For synthetic fabrics
- Neutralises odours thanks to built-in odour absorber
- Prevents static charge in clothes
- Retains the shape and breathability of synthetic fabrics

### Caps DownCare

- For down-filled items
- Retains the elasticity and breathability of down
- Lanolin for effective cleaning and gentle care
- Down does not stick together and retains its loft

### Caps WoolCare

- Woollens and delicates detergent
- Special wheat-protein-based agents
- Fibre-protection technology to help prevent items shrinking and felting
- Colour-protection formula for gentle cleaning

### Caps UltraDark

- Special-purpose detergent for dark and black laundry
- Colour-protection formula for gentle cleaning
- Anti-pilling effect protects your garments from discolouration
- Retains colour intensity and brightness

### Caps CottonRepair

- Special-purpose detergent for cotton fabrics
- Visibly renews fabric with just one wash
- Special Miele formula with No-vozymes technology
- Removes pilling and renews colour intensity and brightness
- Depending on fabric do not use more than 1–2 times per year

### Caps SilkCare

- Silks and delicates detergent
- Special care product made with silk protein
- Preserves the smooth surface of silk textiles
- Gentle cleaning to protect silk fibres

# Detergents and care products

---

## Fabric care

These fabric care products are available as convenient single-use capsules.

### Fabric conditioner cap

- Fabric conditioner for freshly scented laundry
- Pure and thorough cleanliness with a fresh scent
- For soft, bouncy laundry
- Prevents static charge in clothes

### Cap Impraprotect

- Proofing agent for sportswear and waterproof clothing
- Effective proofing to protect against water and wind, and to give a dirt-repellent finish
- Retains the breathability of fabrics

## Additives

Additives are available as convenient single-use capsules.

### Cap Booster

- Highly effective stain remover
- Enzyme technology to help remove stubborn stains
- Suitable for whites and colours
- For best wash results even at low temperatures

## Machine care

### Descaling agent

- Removes heavy limescale deposits
- Mild and gentle with natural citric acid
- Gentle on heater elements, drum and other components

### IntenseClean

- For hygienic cleanliness in washing machines
- Removes grease, bacteria and associated unpleasant odours
- Effective thorough cleaning

### Water softener tablets

- Reduces the amount of detergent needed for hard water
- Less detergent residue in fabrics
- Less chemicals in waste water due to reduced amount of detergent

## United Kingdom

Miele Co. Ltd., Fairacres, Marcham Road, Abingdon, Oxon, OX14 1TW  
Tel: 0330 160 6600, Internet: [www.miele.co.uk](http://www.miele.co.uk), E-mail: [info@miele.co.uk](mailto:info@miele.co.uk)

### Australia

Miele Australia Pty. Ltd.  
ACN 005 635 398  
ABN 96 005 635 398  
Level 4, 141 Camberwell Road  
Hawthorn East, VIC 3123  
Tel: 1300 464 353  
E-mail: [info@miele.com.au](mailto:info@miele.com.au)  
Internet: [www.miele.com.au](http://www.miele.com.au)

### China Mainland

Miele Electrical Appliances Co., Ltd.  
1-3 Floor, No. 82 Shi Men Yi Road  
Jing' an District  
200040 Shanghai, PRC  
Tel: +86 21 6157 3500  
Fax: +86 21 6157 3511  
E-mail: [info@miele.cn](mailto:info@miele.cn)  
Internet: [www.miele.cn](http://www.miele.cn)

### Hong Kong, China

Miele (Hong Kong) Ltd.  
41/F - 4101, Manhattan Place  
23 Wang Tai Road  
Kowloon Bay, Hong Kong  
Tel: (852) 2610 1025  
Fax: (852) 3579 1404  
E-mail:  
[customerservices@miele.com.hk](mailto:customerservices@miele.com.hk)  
Website: [www.miele.hk](http://www.miele.hk)

### India

Miele India Pvt. Ltd.  
1st Floor, Copia Corporate Suites,  
Commercial Plot 9, Mathura Road,  
Jasola, New Delhi - 110025  
E-mail: [customercare@miele.in](mailto:customercare@miele.in)  
Website: [www.miele.in](http://www.miele.in)

### Ireland

Miele Ireland Ltd.  
2024 Bianconi Avenue  
Citywest Business Campus  
Dublin 24  
Tel: (01) 461 07 10  
Fax: (01) 461 07 97  
E-mail: [info@miele.ie](mailto:info@miele.ie)  
Internet: [www.miele.ie](http://www.miele.ie)

### Malaysia

Miele Sdn Bhd  
Suite 12-2, Level 12  
Menara Sapura Kencana  
Petroleum  
Solaris Dutamas No. 1  
Jalan Dutamas 1  
50480 Kuala Lumpur, Malaysia  
Phone: +603-6209-0288  
Fax: +603-6205-3768

### New Zealand

Miele New Zealand Limited  
IRD 98 463 631  
8 College Hill  
Freemans Bay, Auckland 1011  
Tel: 0800 464 353  
E-mail: [customercare@miele.co.nz](mailto:customercare@miele.co.nz)  
Internet: [www.miele.co.nz](http://www.miele.co.nz)

### Singapore

Miele Pte. Ltd.  
29 Media Circle  
#11-04 ALICE@Mediapolis  
Singapore 138565  
Tel: +65 6735 1191  
Fax: +65 6735 1161  
E-mail: [info@miele.com.sg](mailto:info@miele.com.sg)  
Internet: [www.miele.sg](http://www.miele.sg)

### South Africa

Miele (Pty) Ltd.  
63 Peter Place, Bryanston 2194  
P.O. Box 69434, Bryanston 2021  
Tel: (011) 875 9000  
Fax: (011) 875 9035  
E-mail: [info@miele.co.za](mailto:info@miele.co.za)  
Internet: [www.miele.co.za](http://www.miele.co.za)

### Thailand

Miele Appliances Ltd.  
BHIRAJ TOWER at EmQuartier  
43rd Floor Unit 4301-4303  
689 Sukhumvit Road  
North Klongton Sub-District  
Vadhana District  
Bangkok 10110, Thailand

### United Arab Emirates

Miele Appliances Ltd.  
Showroom 1, Eiffel 1 Building  
Sheikh Zayed Road, Umm Al Sheif  
P.O. Box 114782 - Dubai  
Tel. +971 4 3044 999  
Fax. +971 4 3418 852  
800-MIELE (64353)  
E-mail: [info@miele.ae](mailto:info@miele.ae)  
Website: [www.miele.ae](http://www.miele.ae)

**Manufacturer:** Miele & Cie. KG, Carl-Miele-Straße 29, 33332 Gütersloh, Germany

WTD 160

en-GB

M.-Nr. 12 248 220 / 02