

Operating and installation instructions Microwave combination oven



It is **essential** to read the operating and installation instructions before setup, installation, and commissioning. This prevents both personal injury and damage to the appliance.

Contents

Warning and safety instructions	6
Caring for the environment	16
Guide to the appliance	17
Controls	18
On/Off sensor control	19
Movement sensor	19
Sensor controls.....	20
Touch display.....	21
Symbols	22
Using the appliance	23
Selecting a menu option	23
Scrolling	23
Exiting a menu.....	23
Changing a value or setting.....	23
Changing a setting in a list	23
Entering numbers with the roller	23
Entering numbers using the numerical keypad	23
Changing the setting with a segment bar	23
Entering letters	24
Displaying the context menu	24
Moving entries	24
Displaying the pull-down menu.....	24
Displaying Help.....	24
Activating MobileStart.....	24
Features	25
Data plate	25
Scope of delivery	25
Accessories supplied and available to order	25
Safety features.....	28
PerfectClean treated surfaces.....	28
Before using for the first time	29
Miele@home	29
Basic settings.....	30
Heating up the oven for the first time	31
Settings	32
Settings overview.....	32
Opening the “Settings” menu	35
Language 	35
Time.....	35
Date.....	35
Lighting.....	36
Start screen.....	36
Display	36

Volume	36
Units	37
Quick MW	37
Popcorn.....	37
Booster	37
Recommended temps.	38
Recomm. power levels	38
Cooling fan run-on.....	38
Movement sensor	39
Safety	39
Furniture front recognition	40
Miele@home	40
Performing Scan & Connect	41
Remote control	41
Activating MobileStart	41
SuperVision	41
Remote Update	42
Software version.....	43
Legal information	43
Showroom programme.....	43
Factory default	43
Operating hours (total)	43
Alarm + minute minder	44
Using the Alarm function.....	44
Using the Minute minder function.....	45
Main and sub-menus	46
Microwave operation	48
How it works	48
Selecting crockery	48
Suitable crockery	48
Unsuitable crockery.....	50
Testing dishes.....	50
Cover	51
Operation	52
Changing values and settings for a cooking programme	52
Changing the temperature and core temperature	52
Changing the microwave power level	53
Setting cooking durations.....	53
Changing the set cooking durations	53
Deleting the set cooking durations	53
Interrupting a cooking programme in the Microwave function	54
Cancelling a cooking programme.....	54

Contents

Pre-heating the oven compartment	54
Booster.....	55
Pre-heat.....	55
Crisp function.....	56
Changing the function	56
Quick MW and Popcorn	57
Automatic programmes	58
Categories	58
Using automatic programmes	58
Handy hints	58
Search	59
Special applications	60
Defrost	60
Drying.....	63
Reheat.....	64
Heat crockery.....	67
Prove dough	67
Keeping warm	67
Low temp. cooking.....	68
Sabbath programme	69
Cooking.....	71
Frozen food/Ready meals.....	73
MyMiele	74
User programmes	75
Baking.....	78
Tips on baking.....	78
Notes on the cooking charts	78
Notes on the functions	78
Roasting	80
Tips for roasting.....	80
Notes on the cooking charts	80
Notes on the functions	81
Food probe	82
Grilling	84
Tips for grilling.....	84
Notes on the cooking charts	84
Notes on the functions.....	85
Cleaning and care	86
Unsuitable cleaning agents.....	86
Removing normal soiling	87
Removing stubborn soiling.....	87
Lowering the top heat/grill element.....	88
Problem solving guide.....	89

Service	93
Contact in the event of a fault	93
Warranty	93
Installation	94
Installation dimensions	94
Installation in a tall or base unit.....	94
Side view.....	95
Connections and ventilation	96
Installing the oven	97
Electrical connection	98
Cooking charts	99
Batter	99
Shortcrust pastry.....	100
Yeast dough.....	101
Quark dough.....	101
Sponge mixture.....	102
Choux pastry, puff pastry, meringue	102
Savoury dishes.....	103
Beef	104
Veal	105
Pork.....	106
Lamb, game	107
Poultry, fish.....	108
Notes for test institutes	109
Test food according to EN 60350-1.....	109
Test food in accordance with EN 60705 (microwave operating mode )	110
Technical data	111
Declaration of conformity.....	111
UK Conformity declaration	111
Copyrights and licences for the communication module.....	112
Copyrights and Licences	113

Warning and safety instructions

► For the sake of simplicity, the microwave combination oven will subsequently be referred to as the “oven”.

This oven complies with all current local and national safety requirements. However, inappropriate use can lead to personal injury and damage to property.

Read the operating and installation instructions carefully before using the oven. They contain important information on safety, installation, use and maintenance. This prevents both personal injury and damage to the oven.

In accordance with standard IEC/EN 60335-1, Miele expressly and strongly advises that you read and follow the instructions in the chapter on installing the oven as well as the safety instructions and warnings.

Miele cannot be held liable for damage caused by non-compliance with these instructions.

Keep these instructions in a safe place and pass them on to any future owner.

Appropriate use

► This oven is intended for domestic use and use in other similar environments.

► The oven is not intended for outdoor use.

► It is intended for cooking food – and, in particular, for baking, roasting, grilling, reheating, defrosting and drying food – in domestic settings only.

All other types of use are not permitted.

► Fire hazard due to flammable materials.

If flammable items are dried using microwave power, the moisture in the items will evaporate. This could cause the materials to dry out and possibly self-ignite.

Never use the oven to store or dry items which could ignite easily.

► This oven may only be used by people with reduced physical, sensory or mental capabilities or lack of experience and knowledge if they are supervised whilst using it.

They may only use it unsupervised if they have been shown how to use it in a safe manner. They must be able to recognise and understand the dangers of misuse.

Warning and safety instructions

- ▶ The oven compartment is equipped with special lamps to cope with particular conditions (e.g. temperature, moisture, chemical resistance, abrasion resistance and vibration). These special lamps must only be used for the purpose for which they are intended. They are not suitable for room lighting. Replacement lamps may only be fitted by a Miele authorised technician or by the Miele Customer Service Department.
- ▶ The oven contains 1 light source corresponding to energy efficiency class F.

Safety with children

- ▶ Activate the system lock to ensure that children cannot switch the oven on by mistake.
- ▶ Children under 8 years of age must be kept away from the oven unless they are constantly supervised.
- ▶ Children aged 8 and older may only use the oven without supervision if they have been shown how to use it in a safe manner. Children must be able to understand and recognise the possible dangers caused by incorrect operation.
- ▶ Children must not be allowed to clean or maintain the oven unsupervised.
- ▶ Children should be supervised in the vicinity of the oven. Never allow children to play with the oven.
- ▶ Risk of suffocation due to packaging material. Whilst playing, children may become entangled in packaging material (such as plastic wrapping) or pull it over their head, presenting the risk of suffocation.

Keep packaging material away from children.

- ▶ Risk of injury caused by hot surfaces. Children's skin is far more sensitive to high temperatures than that of adults. External parts of the oven such as the door glass, control panel and the vent become quite hot.

Do not let children touch the oven when it is in operation.

- ▶ Risk of injury from the open door.
The oven door can support a maximum weight of 8 kg. Children could injure themselves on an open door.

Do not let children sit on the open door, lean against it or swing on it.

Warning and safety instructions

Technical safety

- ▶ Unauthorised installation, maintenance and repairs can cause considerable danger for the user. Installation, maintenance and repairs must only be carried out by a Miele authorised technician.
- ▶ Damage to the oven can compromise your safety. Check the oven for visible signs of damage. Do not use a damaged oven.
- ▶ Temporary or permanent operation on an autonomous power supply system or a power supply system that is not synchronised with the mains power supply (e.g. island networks, back-up systems) is possible. A prerequisite for operation is that the power supply system complies with the specifications of EN 50160 or an equivalent standard.

The function and operation of the protective measures provided in the domestic electrical installation and in this Miele product must also be maintained in isolated operation or in operation that is not synchronised with the mains power supply, or these measures must be replaced by equivalent measures in the installation. As described, for example, in the current version of BS OHSAS 18001–2 ISO 45001.



- ▶ Operating a damaged oven can result in microwave leakage and present a hazard to the user. Do not use the oven if:
 - the door is warped.
 - the door hinges are loose.
 - holes or cracks are visible in the casing, the door or the oven compartment walls.
- ▶ The electrical safety of this oven can only be guaranteed when correctly earthed. It is most important that this basic safety requirement is fulfilled. If in doubt, the electrical installation should be checked by a qualified electrician.
- ▶ The connection data (voltage and frequency) on the data plate of the oven must match the mains electricity supply in order to avoid the risk of damage to the oven. Compare this before connecting the appliance to the mains. If in any doubt, consult a qualified electrician.
- ▶ Multi-socket adapters and extension leads do not guarantee the required safety of the appliance. Do not use these to connect the oven to the mains electricity supply.
- ▶ For safety reasons, the oven may only be used when it has been built in and fully installed.
- ▶ The oven must not be used in a non-stationary location (e.g. on a ship).

Warning and safety instructions



- ▶ Risk of injury due to electric shock. Any contact with live connections or tampering with the electrical or mechanical components of the oven will endanger your safety and may lead to the oven malfunctioning.
Do not open the oven housing under any circumstances.
- ▶ While the oven is under warranty, repairs should only be undertaken by a Miele authorised service technician. Otherwise the warranty will be invalidated.
- ▶ Miele can only guarantee the safety of the oven when original Miele spare parts are used. Faulty components must only be replaced by original spare parts.
- ▶ If the oven is delivered without a power connection cable, a special cable must be installed by a Miele authorised service technician (see “Installation”, “Electrical connection”).
- ▶ If the connection cable is damaged, it must be replaced with a special connection cable by a Miele authorised service technician (see “Installation”, “Electrical connection”).
- ▶ During installation, maintenance and repair work, the oven must be completely disconnected from the mains electricity supply. To ensure this:
 - disconnect the mains fuse, or
 - completely unscrew the screw-out fuse (in countries where this is applicable), or
 - pull out the plug (if one is present) at the wall socket. To do this, pull the plug and not the mains connection cable.
- ▶ The oven requires a sufficient supply of cool air for efficient operation. Make sure that the supply of cool air is not hindered in any way (e.g. by fitting heat insulation strips in the housing unit). Furthermore, the required supply of cool air must not be excessively heated by other heat sources (e.g. solid fuel stoves).
- ▶ If the oven is built in behind a furniture front (e.g. a door), do not close the furniture door while the oven is in use. Heat and moisture can build up behind the closed furniture door. This can result in damage to the oven, housing unit and floor. Leave the furniture front/door open until the oven has cooled down completely.

Warning and safety instructions

Correct use

- ▶ Risk of injury caused by hot surfaces. The oven gets hot during operation. You could burn yourself on the heating elements, oven compartment, accessories or food.
Wear oven gloves when placing hot food in the oven or removing it and when adjusting oven shelves, for example, in a hot oven compartment.
- ▶ To avoid fuelling any flames, do not open the oven door if smoke occurs inside the appliance. Interrupt the process by switching the appliance off and disconnect it from the mains electricity supply. Do not open the door until the smoke has dispersed.
- ▶ Due to the high temperatures radiated, objects left near the oven could catch fire. Do not use the oven to heat up the room.
- ▶ Oils and fats can ignite if allowed to overheat. Never leave the oven unattended when cooking with oil or fats. Never attempt to put out oil or fat fires with water. Switch the oven off and extinguish the flames by leaving the door closed.
- ▶ Grilling food for excessively long cooking durations can cause it to dry out with the risk of catching fire. Do not exceed the recommended cooking durations.
- ▶ Please be aware that durations when using microwave power are often considerably shorter when cooking, reheating and defrosting than when using functions without microwave power. Excessively long cooking times can lead to food drying out and burning, or could even cause it to catch fire.
Do not exceed recommended grilling times when using grill functions. Do not use the Microwave  function to dry flowers or herbs or to crisp up bread or rolls. Never use grill functions to dry flowers, herbs or the like. Use the Fan plus  or Conventional heat  function and always ensure this type of procedure is supervised.
- ▶ If using alcohol in your recipes, please be aware that high temperatures can cause the alcohol to evaporate. The vapour can catch fire on hot heating elements.

Warning and safety instructions

- ▶ When using residual heat to keep food warm, corrosion from high air humidity and condensation can occur in the oven. This can also cause damage to the control panel, worktop and surrounding kitchen furniture. Keep the oven on and select the lowest temperature available for the selected function. The cooling fan will then continue to run automatically.
- ▶ Food which is stored in the oven compartment or left in it to be kept warm can dry out and the moisture released can lead to corrosion damage in the oven. Always cover food that is left in the oven to keep warm.
- ▶ A build-up of heat can cause damage to the oven. Never line the floor of the oven compartment with aluminum foil or oven liners.
If you wish to place crockery on the floor of the oven compartment during cooking, or place crockery on the floor of the oven compartment to heat it up, you can do so, but only with the Fan plus  or Eco Fan heat  function, without the Booster function.
- ▶ The oven compartment floor can become damaged by items being pushed around on it. When placing pots, pans or crockery on the oven compartment floor, ensure that you avoid pushing them around.
- ▶ Risk of injury caused by steam. Pouring a cold liquid onto a hot surface creates steam, which can cause severe scalding. The sudden temperature change can also cause damage to hot enamelled surfaces. Never pour cold liquids directly onto hot enamelled surfaces.
- ▶ The oven is not suitable for cleaning or disinfecting items. Items can get extremely hot and there is a risk of burning when the item is removed from the oven.
- ▶ It is important that the temperature in the food being cooked is evenly distributed and sufficiently high.
This can be achieved by stirring or turning the food, and observing a sufficiently long standing time (see charts), which should be added to the time needed for reheating, defrosting or cooking.
During the standing time, the temperature is distributed evenly in the food.

Warning and safety instructions

▶ When heating food, and in particular liquids, using the Microwave  function, the boiling point may be reached without the production of typical bubbles. The liquid does not boil evenly throughout. This boiling delay can result in the liquid boiling over explosively. Take care when taking the container out of the oven, as the hot liquid can cause severe scalding. Under certain circumstances, the pressure can be so high that the door opens automatically.

Stir liquids well before heating. After heating, wait at least 20 seconds before removing the container from the oven compartment. In addition, a glass rod or similar item, if available, can be placed in the container during heating.

▶ Risk of injury caused by hot food. When heating food up, the heat is created directly in the food itself. For this reason the crockery will remain cooler than the food (except when using oven-proof stoneware). The crockery is only warmed by the heat of the food. Before serving, always check the temperature of the actual food itself after taking it out of the oven. The temperature of the container is not an indication of the temperature of the food or liquid in it. **This is particularly important when preparing food for babies, children, and the elderly or infirm.** After reheating food, especially food for babies and small children, stir the food or shake the container and check that the temperature does not pose any danger of burning. Double check after it has been left to stand.

▶ Risk of injury from increased pressure in closed containers or bottles. Pressure can build up during reheating in sealed containers or bottles, causing them to explode.

Never cook or reheat food or liquids in sealed containers or bottles. Open containers beforehand. In the case of baby bottles, the screw top and teat must be removed.



▶ If you cook eggs without their shells, the yolks could explode due to the resulting pressure.

Prick the yolk several times before cooking to avoid this.





▶ Eggs heated in their shells can burst, even after they have been taken out of the oven compartment.

Eggs can only be cooked in their shells in a specially designed egg-boiling device. Do not reheat hard boiled eggs using the Microwave  function.

Warning and safety instructions

- ▶ Food with a thick skin or peel, such as tomatoes, sausage, potatoes and aubergines can burst when heated or cooked. Pierce or score the skin of these types of food several times to allow steam to escape.
- ▶ Do not use thermometers containing mercury or liquid as these are not suitable for use with very high temperatures and break very easily.
Only use the Miele food probe supplied with the appliance to measure the temperature of the food.
- ▶ Cushions or pads filled with cherry kernels, gel, etc., such as those used in aromatherapy, can ignite when heated even after they have been removed from the oven compartment.
Do not heat these up in the oven.
- ▶ Containers and lids with hollow handles or knobs can collect moisture in the hollow spaces. When the moisture evaporates, pressure can build up and the item can explode. If the hollow recess is sufficiently ventilated, the item can be used.
Do not use crockery with hollow knobs or handles when using the Microwave  function.
- ▶ Non-microwave-safe plastic dishes can suffer damage or damage the oven if used with the Microwave  function and microwave functions.
Do not use any crockery or cutlery made from or containing metal, aluminium foil, lead crystal glassware, temperature-sensitive plastics, wooden utensils or cutlery, metal clips, or plastic or paper-covered wire ties. Do not use bowls with milled rims, or plastic pots with the foil lid only partially removed (see the requirements specified for crockery in the section on microwave operation).
- ▶ Plastic dishes that are not suitable for use in an oven will melt and may ignite at high temperatures, and can damage the oven.
Use only plastic dishes that are suitable for use in an oven when using functions that do not use microwave power. Follow the manufacturer's instructions.
- ▶ Fire hazard due to containers made of flammable materials. Plastic disposable containers must meet the requirements specified for crockery in the section on microwave operation.
Do not leave the oven unattended when heating or cooking food in disposable containers made of plastic, paper or other inflammable materials.

Warning and safety instructions

- ▶ Heat-retaining bags usually contain a thin layer of aluminium foil that reflects microwave radiation. This reflected energy can, in turn, cause the outer paper covering to become so hot that it ignites. Do not use heat-retaining packaging, such as bags for grilled chicken, for warming food with functions that use microwave power.
- ▶ If the oven is used without food or the food is loaded incorrectly when using the Microwave  operating mode or operating modes that use microwave power, the oven can become damaged. **Always** use the glass tray with the Microwave  operating mode, even if you use it as a container for smaller dishes. Do not use any operating modes that use microwave power to pre-heat crockery or to dry herbs. Instead, use the Fan plus  or Conventional heat  operating mode.
- ▶ Heating up food in closed containers, such as tins or sealed jars, will result in an increase in pressure, which can cause them to explode. Do not heat up unopened tins or jars of food in the oven.
- ▶ Risk of injury from the open door. You could bang into the open door or trip over it. Avoid leaving the door open unnecessarily.
- ▶ The door can support a maximum load of 8 kg. Do not lean or sit on an open door, or place heavy items on it. Make sure that nothing gets trapped between the door and the oven compartment. This could damage the oven.

The following applies to stainless steel surfaces:

- ▶ Adhesives will damage the stainless steel surface and cause it to lose its dirt-repellent protective coating. Do not use sticky notes, adhesive tape or other types of adhesive on the stainless steel surface.
- ▶ Magnets can cause scratches. Do not use the stainless steel surface as a magnetic notice board.

Cleaning and care

- ▶ Risk of injury due to electric shock. The steam from a steam cleaning appliance could reach live electrical components and cause a short circuit. Do not use a steam cleaner to clean the appliance.
- ▶ Scratches on the door glass can cause the glass to break. Do not use abrasive cleaners, hard sponges, brushes or sharp metal tools to clean the door glass.
- ▶ Try to prevent the interior walls being splashed with food containing salt. If this does happen, wipe it away thoroughly to avoid corrosion to stainless steel surfaces inside the oven compartment.
- ▶ In warm, moist environments, there is a higher probability of pest infestations (such as cockroaches). Ensure the oven and the area surrounding it are always kept clean.
Damage caused by pests is not covered by the warranty.

Accessories

- ▶ Only use original Miele accessories. If other parts are used, warranty, performance and product liability claims will be invalidated.
- ▶ Miele will guarantee to supply functional spare parts for a minimum of 10 years and up to 15 years following the discontinuation of your oven.
- ▶ Only use the Miele food probe supplied with the appliance. If it is faulty, it must be replaced with a new original Miele food probe.
- ▶ The plastic on the food probe can melt at very high temperatures. Do not use the food probe when using the grill functions. Do not store the food probe in the oven compartment when it is not being used.

Caring for the environment

Disposing of the packaging material

The packaging material is used for handling and protects the appliance from transport damage. The packaging material used is selected from materials which are environmentally friendly for disposal and can generally be recycled.

Recycling the packaging material reduces the use of raw materials. Use material-specific collection points for valuable materials and take advantage of return options. Your Miele dealer will take the packaging material away.

Disposing of your old appliance

Electrical and electronic appliances contain many valuable materials. They also contain certain materials, compounds and components which were essential for their correct functioning and safety. These could be hazardous to human health and to the environment if disposed of with household waste or if handled incorrectly. Please do not, therefore, dispose of your old appliance with household waste.



Instead, please make use of officially designated collection and disposal points to dispose of and recycle electrical and electronic appliances in your local community, with your dealer or with Miele, free of charge. By law, you are solely responsible for deleting any personal data from the old appliance prior to disposal. You are legally obliged to remove any old batteries which are not securely enclosed by the appliance and to remove any lamps without destroying them, where this is possible. These must be taken to a suitable collection point where they can be handed in free of charge. Please ensure that your old appliance poses no risk to children while being stored for disposal.



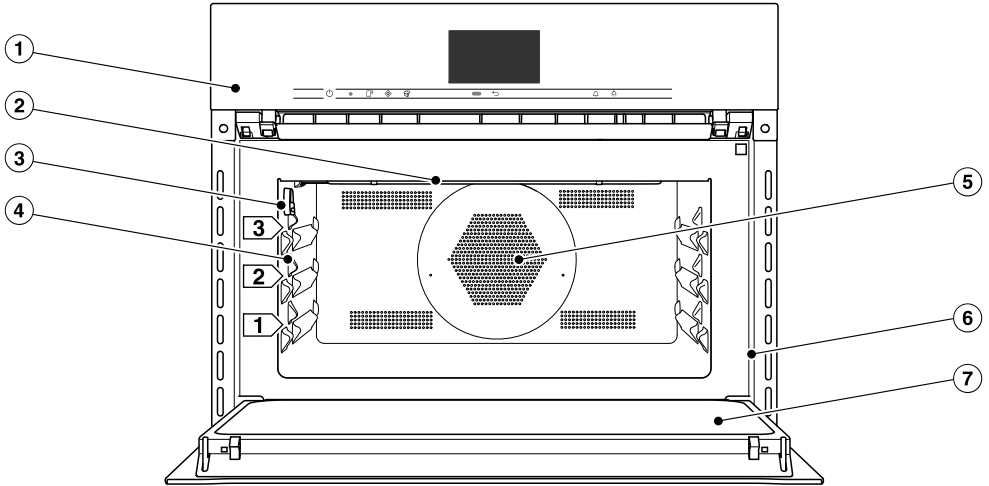



Oven

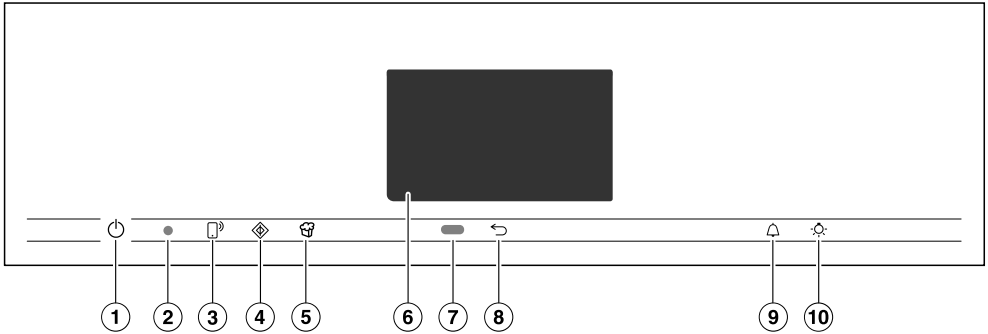

- ① Control elements
- ② Top heat/grill element
- ③ Connection socket for the food probe
- ④ 3 shelf levels for the glass tray and rack
- ⑤ Air inlet for the fan with ring heating element behind it
- ⑥ Front frame with data plate
- ⑦ Door

Controls



- ① Recessed  On/Off sensor control
For switching the oven on and off
- ② Optical interface
(For Miele Service only)
- ③  sensor control
For controlling the oven via your mobile device
- ④  sensor control
For starting the Quick MW function
- ⑤  sensor control
For starting the Popcorn function
- ⑥ Touch display
For displaying information and for operation
- ⑦ Movement sensor
For switching on the oven interior lighting and the display, and to acknowledge the buzzer when movement is detected
- ⑧  sensor control
To go back a step
- ⑨  sensor control
For setting the minute minder or alarms
- ⑩  sensor control
For switching the oven interior lighting on and off

On/Off sensor control

The  On/Off sensor control is recessed and reacts to touch.

Use this sensor control to switch the oven on and off.

Movement sensor

The movement sensor is located under the touch display next to the  sensor control. The movement sensor detects when you approach the touch display, e.g. with your hand or body.







If you have activated the corresponding settings, you can switch on the oven interior lighting, switch on the oven or acknowledge the buzzers (see “Settings – Movement sensor”).

Controls

Sensor controls

The sensor controls react to touch. Every touch of a sensor control is confirmed with an audible tone. This audible tone can be switched off by selecting the **Volume | Keypad tone | Off** setting.

If you want the sensor controls to respond even when the oven is switched off, select the **Display | QuickTouch | On** setting.

Sensor control	Function
	If you want to control the oven from your mobile device, you must have the Miele@home system, switch on the Remote control setting and touch this sensor control. The sensor control then lights up and the MobileStart function is available. As long as this sensor control is lit, you can control the oven via your mobile device (see “Settings – Miele@home”).
	Use this sensor control to start the Quick MW function. The cooking process runs with a preset microwave power level of 600 W and a cooking duration of 1 minute (see “Quick MW”). Touching this sensor control repeatedly increases the cooking duration in increments. This function can only be used when no other cooking processes are in use.
	Use this sensor control to start the Popcorn function. The cooking programme runs with 850 W and a cooking duration of 2:50 minutes (see “Popcorn”). This function can only be used when no other cooking programmes are in use.
	Depending on which menu you are in, this will take you back a level or back to the main menu.
	If a menu appears in the display or if a cooking programme is in progress, you can use this sensor control to set a minute minder (e.g. when boiling eggs) or an alarm (a specific time) at any point (see “Alarm and minute minder”).
	Select this sensor control to switch the oven interior lighting on and off. Depending on the setting selected, the oven interior lighting switches off after 15 seconds or remains constantly switched on or off.

Touch display

The sensitive surface of the touch display can be scratched by pointed or sharp objects, e.g. pens.

Only touch the display with your fingers.

Make sure that water cannot get behind the touch display.

The touch display is split into multiple areas.

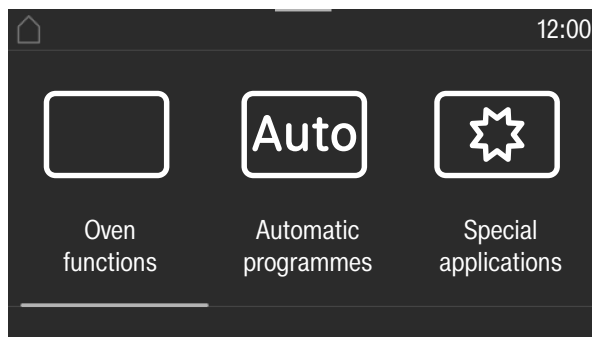

The menu path appears on the left of the **header**. The individual menu options are separated by a vertical line. ... I indicates that there are more options available, which are not visible because there is not enough space in the display.

If you touch a menu name in the header, the display will switch to that menu. To switch to the status display, touch .

The time of day is shown on the right of the header. You can set the time of day by touching the display.

Additional symbols may also appear, e.g. SuperVision .

At the top of the header there is an orange line where you can drag down the pull-down menu. This allows you to switch settings on or off during a cooking programme.









The current menu and menu options are shown in the **centre**. You can scroll to the right or left by swiping your finger across the display to the right or left. Touch a menu option to select it (see “Operation”).

The operation fields that appear in the **footer** vary according to the menu that is selected; for example: Timer, Save or OK.

Controls

Symbols

The following symbols may appear in the display:

Symbol	Meaning
	This symbol indicates that there is additional information and advice about using the appliance. Press the <i>OK</i> sensor control to confirm the information.
	This indicates that there are more options available, which are not visible because there is not enough space in the display.
	Alarm
	Minute minder
	Some settings, e.g. display brightness and buzzer volume are selected using a bar chart.
	The system lock or sensor lock is on (see “Settings – Safety”). The controls are locked.
	Core temperature when using the food probe
	Remote control (only appears if you are in the Miele@home system and have selected the Remote control On setting)
	SuperVision (only appears if you are in the Miele@home system and have selected the SuperVision SuperVision display On setting)

You operate the oven via the touch display by touching the desired menu option.

Each time you touch a possible option, the relevant characters (word and/or symbol) light up **orange**.

Fields for confirming an operating step are highlighted in **green** (e.g. *OK*).

Selecting a menu option

- Touch the field or value you want in the display.

Scrolling

You can scroll left or right.

- Swipe across the screen. To do this, place your finger on the touch display and swipe it in the direction you want. The bar at the bottom shows you where you are in the current menu.

Exiting a menu

- Touch the ↶ sensor control or touch the ... I symbol in the menu path.
- Touch the ⏪ symbol to switch to the status display.

Entries made before this which have not been confirmed with *OK* will not be saved.

Changing a value or setting

Changing a setting in a list

The current setting is highlighted in orange.

- Touch the desired setting. The setting is now saved. This will take you back to the previous menu.

Entering numbers with the roller

- Swipe the roller up or down until the value you want is displayed in the centre.
- Confirm with *OK*.

The changed number is now saved.

Entering numbers using the numerical keypad

- Tap on the value that is in the middle of the numerical keypad.

The numerical keypad will appear.

- Touch the desired numbers.

As soon as you enter a valid value, *OK* turns green.

Use the arrow to delete the last entered number.

- Confirm with *OK*.

The changed number is now saved.

Changing the setting with a segment bar

Some settings are represented by a bar  with seven segments. If all of the segments are illuminated, the maximum value is selected.

If none of the segments are illuminated or if only one is, the minimum value is selected or the setting is switched off altogether (e.g. buzzers).

- Touch the corresponding segment on the segment bar to change the setting.
- Select *On* or *Off* to switch the setting on or off.
- Confirm your selection with *OK*.

The setting is now saved. This will take you back to the previous menu.

Using the appliance

Entering letters

Letters are entered using a display keyboard. It is best to select short names.

- Touch the desired letters or characters.

Tip: You can add a line break for longer programme names using the  symbol.

- Touch **Save**.

The name is now saved.

Displaying the context menu

In some menus you can display a context menu, e.g. to rename User programmes or to move entries under MyMiele.

- For example, touch a User programme and keep your finger on it until the context menu opens.
- To close the context menu, touch an area of the display located outside of the menu window.

Moving entries

You can change the order of User programmes or entries under MyMiele.

- For example, touch a User programme and keep your finger on it until the context menu opens.
- Select **Move**.
- Keep your finger on the highlighted field and drag it to the desired location.

Displaying the pull-down menu

During a cooking programme, you can switch settings such as **Booster** or **Pre-heat** and the  **WiFi** function on or off.

- Use the orange line under the header to drag the pull-down menu down.
- Select the setting you want to change.
Active settings are highlighted in orange. Depending on the selected colour scheme, inactive settings are highlighted either in black or white (see “Settings – Display”).
- To close the pull-down menu, drag it back up to the top or touch an area of the display located outside of the menu window.

Displaying Help

Context-sensitive help is available for certain functions. In this case, **Help** appears in the bottom line.

- Touch **Help** to display information in text and pictures.
- Touch **Close** to return to the previous menu.

Activating MobileStart

- Select the  sensor control to activate MobileStart.

The  sensor control lights up. You can operate your oven remotely with the Miele app.

Directly operating the oven takes priority over operating it via the remote control function on the app.

You can use MobileStart as long as the  sensor control is lit up.

A list of the models described in these operating and installation instructions can be found on the back page of this booklet.

Data plate

The data plate is located on the front frame, visible when the door is open.

The data plate states the model number, the serial number as well as connection data (voltage, frequency and maximum rated load).

Please have this information to hand, should you need to contact Miele regarding any questions or problems.

Scope of delivery

- The operating and installation instructions for using the oven and microwave functions
- A cookbook with recipes for the automatic programmes and other functions
- Food probe
- Screws for securing your oven in the housing unit
- Various accessories

Accessories supplied and available to order

This oven is supplied with a glass tray, a rack and a food probe.

All the accessories listed as well as the cleaning and care products are designed for Miele ovens.

These are available to order via the Miele Webshop, the Miele Customer Service Department or from your Miele dealer.

When ordering, please quote the model identifier of your oven and the reference number of the accessories required.

Glass tray



The glass tray is suitable for use with all cooking functions.

The glass tray can be damaged by large temperature fluctuations.

Do not place the hot glass tray on a cold surface, such as a tiled or granite worktop. Use a suitable mat or pot rest.

- **Always** use the glass tray with the Microwave  operating mode, even if you use it as a container for smaller dishes.
- The maximum load for the glass tray is 8 kg.

Rack with non-tip safety notches

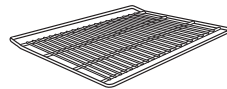

The rack is **not** suitable for use with the Microwave  function. You can use the rack for all other functions which use or do not use microwave power.

 Risk of injury caused by hot surfaces.

The rack gets hot during cooking programmes.

Use oven gloves when placing food in the oven or removing it and when working in the hot oven compartment.

The oven and rack can be damaged by the possible creation of sparks.

Do no use the rack for cooking programmes with the Microwave  function.

Do not place the rack on the oven floor but use it on one of the shelf levels.

Features

Using the rack

The rack has non-tip safety notches which prevent it being pulled right out when it only needs to be pulled out partially.

If you insert the rack the wrong way round, the non-tip safety mechanism is not guaranteed.

When pushing the rack back in, always ensure that the safety notches are at the **back** of the oven.

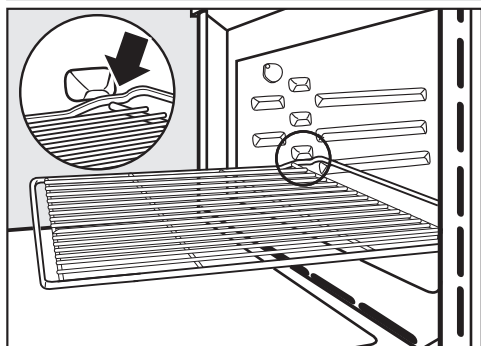

- To remove the rack, lift it upwards slightly at the front when the safety notches connect with the sides of the oven.

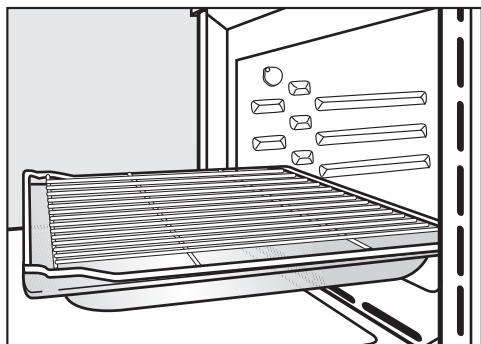





- We recommend using the rack together with the glass tray when cooking items on the rack which might drip.

Only in this case should the safety notches be at the front.

- The maximum load for the rack is 8 kg.

Round baking trays

The round baking trays can suffer damage when subjected to microwaves.

Do not use the round baking trays with the Microwave , MW + Auto roast , MW + Fan plus , MW + Grill  or MW + Fan grill  functions.



The **solid round baking tray HBF 27-1** is suitable for cooking pizzas, flat cakes made with yeast or creamed mixtures, sweet and savoury tarts, baked desserts, flat bread, and can also be used for frozen cakes and pizzas.

The **perforated round baking and AirFry tin HBFP 27-1** can be used for the same purposes as the **Gourmet baking and AirFry tray, perforated HBBL 71**.

The enamelled surface of both items of bakeware has been treated with PerfectClean.

- Insert the rack and place the round baking tray on the rack.

Baking stone HBS 70



The baking stone is ideal for items which need a well baked base such as pizza, quiche, bread, bread rolls and savoury snacks.

The baking stone is made from heat-retaining fireclay and is glazed. A paddle made of untreated wood is supplied with the baking stone for placing food on it and taking it off.

- Slide the rack in and place the baking stone on it.

Food probe

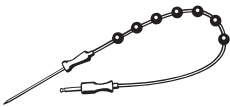

Using the food probe enables the temperature during the cooking programme to be monitored very precisely (see “Roasting – Food probe”).

HUB Gourmet oven dishes HBD Gourmet oven dish lids

Gourmet oven dishes and their lids can suffer damage when subjected to microwaves. Metal reflects the microwaves which can create sparks and the microwaves are not absorbed by the metal.

Only use the oven dishes and their lids for cooking programmes with functions which **do not use** microwave power.

Slide the rack onto shelf level 1 and place the Gourmet oven dish on the rack.

The surface of the Gourmet oven dishes has a non-stick coating and is suitable for induction hobs.

Gourmet oven dishes are available in different depths. The width and the height are the same.

Suitable lids are available separately. Please quote the model number when ordering.

Depth: 22 cm

HUB 62-22

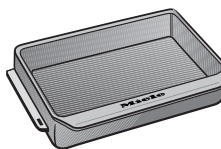

HBD 60-22

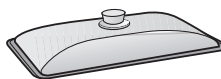

Depth: 35 cm*

HUB 62-35

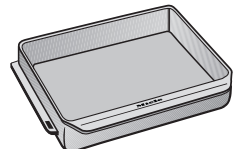

HBD 60-35

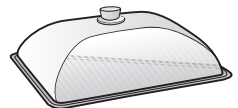

- * The oven dish cannot be used in conjunction with its lid in ovens with 3 shelf levels because the total height of these two items exceeds the height of the oven compartment.

Features

Accessories for cleaning and care

- Miele all-purpose microfibre cloth
- Miele oven cleaner

Safety features

- **System lock** 
(see “Settings – Safety”)
- **Sensor lock**
(see “Settings – Safety”)
- **Cooling fan**
(see “Settings – Cooling fan run-on”)
- **Safety switch-off**
A function which does not use microwave power can be started without selecting a cooking duration. To prevent continuous use and avoid the risk of fire, the oven will switch itself off automatically after a certain time depending on the function and temperature selected.

PerfectClean treated surfaces

PerfectClean surfaces have very good non-stick properties and are exceptionally easy to clean.

Food can be easily removed from these surfaces. Soiling from baking and roasting can be easily removed from these surfaces.

Food can be sliced or cut up on PerfectClean surfaces.

However, do not use ceramic knives as these will scratch the PerfectClean surface.

Surfaces treated with PerfectClean enamel can be cleaned as you would clean glass.

Read the instructions in “Cleaning and care” so that the benefits of the non-stick properties and easy cleaning are retained.

PerfectClean treated surfaces:

- Oven compartment
- Rack
- Round baking and AirFry tin, perforated
- Round baking tray

Before using for the first time

Miele@home

Your oven is equipped with an integrated WiFi module.

In order to use it, you will need:

- A WiFi network
- The Miele app
- A Miele user account The user account can be created via the Miele app.

The Miele app will guide you as you connect your oven to your home WiFi network.

Once your oven is connected to your WiFi network, you can use the app, for example, to carry the following activities:

- Call up information on the operating status of your oven
- Retrieve information on oven cooking programmes that are in progress
- End cooking programmes that are in progress

Connecting your oven to your WiFi network will increase energy consumption, even when the oven is switched off.

Make sure that the signal of your WiFi network is sufficiently strong in the place where your oven is installed.

Availability of the WiFi connection

The WiFi connection shares a frequency range with other appliances (including microwave ovens and remote control toys). This can give rise to sporadic or even complete connection failures. Therefore, the availability of featured functions cannot be guaranteed.

Miele@home availability

The ability to use the Miele app depends on the availability of the Miele@home service in your country.

The Miele@home service is not available in every country.

For information about availability, please visit www.miele.com.

Miele App

The Miele App is available to download free of charge from the Apple App Store® or from the Google Play Store™.



Before using for the first time

Basic settings

The following settings must be made before starting up for the first time. You can change these settings again at a later time (see “Settings”).

 Risk of injury caused by hot surfaces.

The oven gets hot during operation. For safety reasons, the oven may only be used when it has been fully installed.

The oven will switch on automatically when it is connected to the electricity supply.

Setting the language

- Select the desired language.

If you have selected the wrong language by mistake, proceed as described in “Settings –  Language”.

Setting the location

- Select the required location.

Setting up Miele@home

Set up “Miele@home”? will appear in the display.

- To set up Miele@home now, select *Continue*.
- To set it up at a later date, select *Skip*. See “Settings – Miele@home” for information on setting up at a later date.
- To set up Miele@home now, select the desired connection method.

You will then be guided by the display and the Miele app.

Setting the date

- Set the day, then the month, and finally the year.
- Confirm with *OK*.

Setting the time

- Set the time of day in hours and minutes.
- Confirm with *OK*.

Completing the commissioning process

- Follow any further instructions in the display.

The oven is now ready for use.

Before using for the first time



Heating up the oven for the first time

When the oven is heated up for the first time it may give off a slight smell. This can be eliminated by heating the empty oven for at least an hour.

It is important to ensure that the kitchen is well ventilated during this operation.
Prevent the odour from escaping into other rooms.

- Remove any protective wrapping and stickers from the oven and accessories.
- Take all accessories out of the oven compartment and clean them (see “Cleaning and care”).
- Before heating the oven up, wipe the interior with a damp cloth to remove any dust or bits of packaging that may have accumulated in the oven compartment during storage and unpacking.
- Turn the oven on using the On/Off  sensor control.

The main menu will appear.

- Select Oven functions .
- Select Fan plus .

The recommended temperature will appear (160 °C).

The oven heating, lighting and cooling fan will switch on.

- Set the maximum possible temperature (250 °C).
- Confirm with *OK*.

Heat the oven for at least an hour.

- After at least an hour, switch the oven off with the On/Off  sensor control.

Cleaning the oven compartment after heating it up for the first time

 Risk of injury caused by hot surfaces.

The oven gets hot during operation. You could burn yourself on the heating elements and oven compartment.





Allow the heating elements and oven compartment to cool before manual cleaning.

- Clean the oven compartment with a clean sponge and a solution of hot water and washing-up liquid or a damp microfibre cloth.
- Dry all surfaces with a soft cloth.

Leave the oven door open until the oven compartment is completely dry.

Settings

Settings overview

Menu option	Available settings
Language 	... deutsch english ... Location
Time	Display On Off* Night dimming Clock type Analogue* Digital Clock format 24 h* 12 h (am/pm) Set
Date	
Lighting	On "On" for 15 seconds* Off
Start screen	Main menu* Oven functions Automatic programmes Special applications User programmes MyMiele
Display	Brightness  Colour scheme Bright Dark* QuickTouch On Off*
Volume	Buzzer tones Melodies  Solo tone  Keypad tone  Welcome melody On* Off

* Factory default setting

Menu option	Available settings
Units	Weight g* lb lb/oz Temperature °C* °F
Quick MW	Power level Duration
Popcorn	Duration
Booster	On* Off
Recommended temps.	
Recomm. power levels	
Cooling fan run-on	Time controlled Temperature controlled*
Movement sensor	Switch the light on during cooking process* Always on Off Switch appliance on On Off* Acknowledge buzzer On* Off
Safety	System lock  On Off* Sensor lock On Off*
Furniture front recognition	On Off*
Miele@home	Activate Deactivate Connection status Set up again Reset Set up
Remote control	On* Off

* Factory default setting

Settings

Menu option	Available settings
SuperVision	SuperVision display On Off* Display in standby On Only if there is a fault* Appliance list Display this appliance Buzzer tones
Remote Update	On* Off
Software version	
Legal information	Open source licences
Showroom programme	Demo mode On Off*
Factory default	Appliance settings User programmes MyMiele Recomm. power levels Recommended temps.
Operating hours (total)	

* Factory default setting

Opening the “Settings” menu

In the  Settings menu, you can personalise your oven by adapting the factory default settings to suit your requirements.

You are in the main menu.

- Select  Settings.
- Select the desired setting.



You can check settings or change them.

Settings cannot be changed while a cooking process is in progress.

Language

You can set your language and location.

After selecting and confirming your choice, the language you have selected will appear in the display.

Tip: If you have selected the wrong language by mistake, select  in the main menu. Follow the  symbol to get back to the Language  sub-menu.

Time

Display

Select how you want the time of day to show in the display when the oven is switched off:

- On
The time always appears in the display. Changing this setting increases energy consumption.

If you also select the Display | QuickTouch | On setting, all sensor controls react to touch straight away and the movement sensor automatically detects when you approach the display.

If you also select the Display | QuickTouch | Off setting, the oven has to be switched on before it can be used.

- Off
To save energy, the display does not light up. The oven has to be switched on before it can be used.
- Night dimming
The time only shows on the display between 5:00 a.m. and 11:00 p.m. The display remains dark at all other times. Changing this setting increases energy consumption.

Clock type

The time of day can be displayed as Analogue (with a clock face) or Digital (h:min) format.

With the digital display, the date is also shown.

Clock format

The time of day can be displayed in the 24 or 12-hour format (24 h or 12 h (am/pm)).

Set

Set the hours and the minutes.

Tip: If no cooking programme is in progress, touch the time in the header to change it.

If there is a power cut, the current time of day will reappear once power has been restored. The time of day is saved for approx. 150 hours.

If the oven has been connected to a WiFi network and signed into the Miele app, the time will be synchronised based on the location setting in the Miele app.



Date

Set the date.

When the oven is switched off, the date will only appear in the display if the Time | Clock type | Digital setting has been selected.

Settings

Lighting

- On
The oven interior lighting is switched on during the entire cooking period.
- "On" for 15 seconds
The oven interior lighting switches off 15 seconds after a cooking programme has begun. Press the  sensor control to switch the oven interior lighting on again for 15 seconds.
- Off
The oven interior lighting is switched off. Press the  sensor control to switch on the oven interior lighting for 15 seconds.

Start screen

The oven is factory-set for the main menu to appear when the oven is switched on. You can change this default setting so that, for instance, the oven functions or MyMiele settings appear in the status display (see "MyMiele").



This new status display will then appear when the oven is next switched on.

Select the  sensor control or follow the path in the header to get to the main menu.

Display

Brightness

The display brightness is represented by a bar with seven segments.

- 
Maximum brightness
- 
Minimum brightness

Colour scheme

Choose between a light or dark colour scheme for the display.

- Bright
The display has a light background with dark characters.
- Dark
The display has a dark background with white characters.

QuickTouch

Select how the sensor controls and the movement sensor should respond when the oven is switched off:

- On
If you have also selected the Time | Display | On or Night dimming setting, the sensor controls and the movement sensor will also respond when the oven is switched off. Changing this setting increases energy consumption.
- Off
Independently of the Time | Display setting, the sensor controls and the movement sensor only respond when the oven is switched on, as well as for a certain amount of time after switching it off.

Volume

Buzzer tones

If buzzers are switched on, a buzzer will sound when the set temperature is reached and at the end of a set time.

Melodies

At the end of a process, a melody will sound several times in intervals.

The volume of the melody is represented by a bar with seven segments.



Maximum volume



Melody is switched off

Solo tone

At the end of a process, a continuous tone will sound for a period of time.

The pitch of this continuous tone is represented by a segment bar.



Maximum pitch



Minimum pitch

Keypad tone

The volume of the tone that sounds each time you touch a sensor control is represented by a bar with seven segments.



Maximum volume



Tone is switched off

Welcome melody

The melody that sounds when you touch the  On/Off sensor control can be switched on or off.

Units

Weight

For automatic programmes, you can set the weight of food in grams (g), pounds/ounces (lb) or pounds (lb/oz).

Temperature

You can set the temperature in degrees Celsius (°C) or degrees Fahrenheit (°F).

Quick MW

The maximum microwave power level of 600 W and the maximum cooking duration of 1 minute are preset for starting the microwave oven immediately.

- Power level

The following microwave power levels can be selected: 80 W, 150 W, 300 W, 450 W, 600 W, 850 W or 1000 W.

- Duration

The maximum cooking duration that can be set depends on the microwave power level selected:

80–300 W: maximum 10 minutes

450–1000 W: maximum 5 minutes

Popcorn

A microwave power level of 850 W and a cooking duration of 2:50 minutes is pre-set so that you can start cooking a bag of microwave popcorn immediately. These settings match the manufacturer's instructions on most bags of microwave popcorn.

The maximum cooking duration that can be set is 4 minutes.

The microwave power level is set and cannot be modified.

Booster

The Booster function is used to quickly pre-heat the oven compartment.

- On

The Booster function is automatically switched on during the heating-up phase of a cooking programme. The top heat/grill element, ring heating element and hot air fan pre-heat the oven compartment to the desired temperature at the same time.

Settings

- Off
The Booster function is switched off during the heating-up phase of a cooking programme. Only the heating elements associated with the function are pre-heating the oven compartment.

You can also use the pull-down menu to switch the Booster function on or off for a cooking programme.

Recommended temps.

If you often cook with different temperatures, it makes sense to change the recommended temperatures.

After selecting this menu option, a list of operating modes will appear in the display.

- Select the relevant operating mode.

The recommended temperatures are displayed along with the available temperature range.

- Change the recommended temperatures.
- Confirm with *OK*.





Changing the recommended temperatures also affects the corresponding function which uses microwave power.

Recomm. power levels

If you often cook with different power levels, it makes sense to change the recommended microwave power levels.

You can change the recommended power levels for the Microwave  function and for the functions which use microwave power.

After selecting this menu option, a list of functions will appear in the display together with their recommended power levels.

- Microwave :
80 W, 150 W, 300 W, 450 W,
600 W, 850 W, 1000 W
- MW + Auto roast , MW + Fan plus ,
MW + Grill  and MW + Fan grill :
80 W, 150 W, 300 W

- Select the desired function.
- Change the recommended power level.
- Confirm with *OK*.

Cooling fan run-on

The cooling fan will continue to run for a while after the oven has been switched off to prevent any humidity building up in the oven compartment, on the fascia panel or on the oven housing unit.

- Temperature controlled
The cooling fan switches off when the temperature in the oven drops below 70 °C.
- Time controlled
The cooling fan switches off after a period of about 25 minutes.

Condensate can damage the oven housing unit and the worktop and lead to corrosion in the oven.

If you have set the cooling fan to Time controlled and leave food in the oven compartment to keep warm, moisture levels in the oven will increase, leading to condensation forming on the fascia panel and surrounding kitchen furniture, and drops of moisture collecting under the worktop.

Do not leave food in the oven compartment to keep it warm if you have selected Time controlled.

Movement sensor

The movement sensor detects when you approach the touch display, e.g. with your hand or body.

If you want the movement sensor to respond even when the oven is switched off, select the **Display | QuickTouch | On** setting.

Switch the light on

- during cooking process
As soon as you approach the touch display during a cooking programme, the oven interior lighting switches on. The oven interior lighting automatically switches off again after 15 seconds.
- Always on
As soon as you approach the touch display, the oven interior lighting switches on. The oven interior lighting automatically switches off again after 15 seconds.
- Off
The movement sensor does not respond when you approach the touch display. Select the  sensor control to switch on the oven interior lighting for 15 seconds.

Switch appliance on

- On
If the time is displayed, the oven switches on and the main menu appears as you approach the touch display.
- Off
The movement sensor does not respond when you approach the touch display. Turn the oven on using the **On/Off**  sensor control.

Acknowledge buzzer

- On
As soon as you approach the touch display, the buzzers switch off.
- Off
The movement sensor does not respond when you approach the touch display. Switch the buzzers off manually.

Safety

System lock

The system lock prevents the oven being switched on by mistake.

You can still set an alarm and a minute minder as well as use the MobileStart function when the system lock is active.

The system lock will remain activated even after a power failure.

- On
The system lock has been activated. If you want to use the oven, switch it on and touch the  symbol for at least 6 seconds.
- Off
The system lock is deactivated. You can use the oven as normal.

Sensor lock

The sensor lock prevents the cooking programme being switched off by mistake or settings being changed. Apart from the  On/Off sensor control, the activated sensor lock prevents the sensor controls and fields in the display from working a few seconds after a programme has been started.

Settings

- On
The sensor lock is activated. Touch *OK* for at least 6 seconds to deactivate the sensor lock for a short period of time.
- Off
The sensor lock is deactivated. All sensor controls react to touch as normal.

Furniture front recognition

- On
The furniture front detection is activated. Using the movement sensor, the oven automatically detects whether the furniture door is closed.
If the furniture door is closed, the oven switches off automatically after a certain period.
- Off
The furniture front detection is deactivated. The oven does not detect whether the furniture door is closed.

If the oven is installed behind a decorative furniture panel (e.g. a door), the oven, housing unit and the floor can be damaged by the build up of heat and moisture behind the closed furniture panel.

Always leave the furniture door open when you are using the oven.

Leave the furniture door open until the oven has cooled down completely.

Miele@home

The oven is a Miele@home-compatible appliance with SuperVision functionality.

Your oven is fitted ex-works with a WiFi communication module and is suitable for wireless communication.

There are a number of ways of connecting your oven to your WiFi network. We recommend connecting your oven to your WiFi network with the help of the Miele app or via WPS.

- Activate
This setting is only visible if Miele@home is deactivated. The WiFi function is reactivated.
- Deactivate
This setting is only visible if Miele@home is activated. Miele@home remains set up, the WiFi function is switched off.
- Connection status
This setting is only visible if Miele@home is activated. The display shows information such as the WiFi reception quality, network name and IP address.
- Set up again
This setting is only visible if a WiFi network has already been set up. Reset the network settings and immediately set up a new network connection.
- Reset
This setting is only visible if a WiFi network has already been set up. The WiFi function is deactivated and the WiFi network connection will be reset to the factory default. You must set up a new WiFi network connection to be able to use Miele@home.
The network settings should be reset

whenever an oven is being disposed of or sold, or if a used oven is being put into operation. This is the only way to ensure that all personal data has been removed and the previous owner will no longer be able to access the oven.

- Set up
This setting is only visible if no WiFi network connection has been set up yet. You must set up a new WiFi network connection to be able to use Miele@home.

Performing Scan & Connect

Initial commissioning has been carried out without Miele@home having been set up.

- Scan the QR code.

If you have installed the Miele app and have a user account, you will be taken directly to the networking steps.

If you have not yet installed the Miele app, you will be taken to the Apple App Store® or the Google Play Store™.

- Install the Miele app and set up a user account.
- Scan the QR code again.

The Miele app will guide you through the setup process.



Remote control

If you have installed the Miele app on your mobile device, have access to the Miele@home system and have activated the remote control function

(On), you can use the MobileStart function and for example retrieve information about oven cooking processes that are in progress or end a process that is in progress.

The oven requires max. 2 W when operating in networked standby.

Activating MobileStart

- Select the  sensor control to activate MobileStart.

The  sensor control lights up. You can operate your oven remotely with the Miele app.

Directly operating the oven takes priority over operating it via the remote control function on the app.

You can use MobileStart as long as the  sensor control is lit up.

SuperVision

The oven is a Miele@home-compatible appliance with SuperVision functionality for monitoring other household appliances in the Miele@home system.

The SuperVision function cannot be activated until the Miele@home system has been set up.

SuperVision display

- On
The SuperVision function is switched on.
The  symbol will appear in the top right-hand side of the display.
- Off
The SuperVision function is switched off.

Settings

Display in standby

The SuperVision function is also available when the oven is in standby. However, the time-of-day display must be switched on (Settings | Time | Display | On).

- On
Active household appliances that are signed into the Miele@home system are always displayed.
- Only if there is a fault
Only faults on active household appliances are shown.

Appliance list

All household appliances signed in to the Miele@home System are shown. Once you have selected an appliance, you can access further settings:

- Display this appliance
 - On
The SuperVision function for this appliance is switched on.
 - Off
The SuperVision function for this appliance is switched off. The appliance is still signed on to the Miele@home system. Faults are displayed, even if the SuperVision function for the appliance has been switched off.
- Buzzer tones
You can select whether the buzzers are switched on (On) or switched off (Off) for this appliance.

Remote Update

The Remote Update menu option is only displayed and can only be selected if the requirements for using Miele@home have been met (see “Before using for the first time – Miele@home”).

The RemoteUpdate function is used for updating the software in your oven. If an update is available for your oven, it will automatically download it. Updates will not be installed automatically. They must be initiated manually.

If you do not install an update, you can continue to use your oven as usual. However, Miele recommends installing updates.

Activating/deactivating

The RemoteUpdate function is activated as standard. Available updates will be downloaded automatically but will only be installed if you initiate installation manually.

Deactivate RemoteUpdate if you do not want any updates to be downloaded automatically.

Running a RemoteUpdate

Information about the content and scope of an update will be provided in the Miele app.

A message will appear in your oven display if a software update is available. You can install the update immediately or postpone this until later. When the oven is switched on again, you will be reminded about the update.

Deactivate RemoteUpdate if you do not want to install the update.

The update may take several minutes.

Please note the following information about the RemoteUpdate function:

- You will only receive a message when an update is available.
- Once an update has been installed, it cannot be undone.
- Do not switch the oven off during the update. Otherwise, the update will be aborted and will not be installed.
- Some software updates can only be carried out by the Miele Customer Service Department.

Software version

The software version is intended for the Miele Customer Service Department. You do not need this information for domestic use.

- Confirm with *OK*.

Legal information

You can find an overview of the integrated Open Source components under Open source licences.

- Confirm with *OK*.

Showroom programme

This function enables the oven to be demonstrated in showrooms without heating up. This setting is not needed for domestic use.

Demo mode

If you have demo mode activated, Demo mode switched on. The appliance will not heat up will appear when you switch the oven on.

- On
Touch *OK* for at least 4 seconds to activate demo mode.

- Off
Touch *OK* for at least 4 seconds to deactivate demo mode. You can use the oven as normal.

Factory default

- Appliance settings
Any settings that have been altered will be reset to the factory default settings.
- User programmes
All User programmes will be deleted.
- MyMiele
All MyMiele entries will be deleted.
- Recomm. power levels
Microwave power levels which have been changed will be reset to the factory default settings.
- Recommended temps.
Any recommended temperatures that have been changed will be reset to the factory default settings.

Operating hours (total)

Select Operating hours (total) to query the total number of operating hours of your oven.

Alarm + minute minder



Using the  sensor control, you can set a minute minder, e.g. for boiling eggs, or an alarm for a specific time.

Using the Alarm function

The  alarm can be used to specify a particular time for a buzzer to sound.

Setting the alarm

If the Display | QuickTouch | Off setting is selected, you will need to switch the oven on before setting the alarm. The alarm time will then appear in the display when the oven is switched off.

- Select the  sensor control.
- Select  Alarm.
- Set the time for the alarm.
- Touch **Close** to confirm.

When the oven is switched off, the alarm time and  will appear instead of the time of day.

If you are cooking at the same time or if you are in a different menu, the alarm time and  will appear at the top right-hand side of the display.

At the specified time for the alarm,  will flash in the display next to the time and a buzzer will sound.

- Select the  sensor control or the set alarm time in the display.

The buzzer will stop and the symbols in the display will go out.

Changing an alarm

- Select the alarm in the display or select the  sensor control and the desired alarm.

The set alarm time appears in the display.

- Set the new time for the alarm.
- Touch **Close** to confirm.

The adjusted alarm time is now saved and will appear in the display.

Deleting an alarm

- Select the alarm in the display or select the  sensor control and the desired alarm.

The set alarm time appears in the display.

- Select **Delete**.
- Touch **Close** to confirm.

The alarm will be deleted.

Using the Minute minder function

The  minute minder can be used to time other activities in the kitchen, e.g. boiling eggs.

The minute minder can also be used at the same time as a cooking programme for which the cooking duration start and finish times have been set (e.g. as a reminder to stir the food or add seasoning, etc.).



- The maximum minute minder time that can be set is 59 minutes and 59 seconds.

Tip: When using a function that uses moisture, use the timer to remind you to inject steam manually at the desired time.

Setting the minute minder

If you have selected the Display | QuickTouch | Off setting, you will need to switch the oven on before setting the minute minder. The minute minder can then be seen counting down in the display when the oven is switched off.

Example: you want to boil some eggs and set a minute minder duration of 6 minutes and 20 seconds.

- Select the  sensor control.
- Select  Minute minder.
- Set the minute minder time you require.
- Touch  to confirm.

When the oven is switched off, the minute minder time counts down in the display and  appears instead of the time of day.

If you are cooking at the same time or if you are in a different menu, the minute minder time and  will appear at the top right-hand side of the display.

At the end of the minute minder time,  will flash, the time will start counting up and a buzzer will sound.

- Select the  sensor control or the desired minute minder in the display.

The buzzer will stop and the symbols in the display will go out.

Changing the minute minder duration

- Select the minute minder in the display or select the  sensor control and then the desired minute minder duration.

The minute minder duration selected will appear.



- Set a new minute minder duration.
- Touch  to confirm.

The changed minute minder duration is now saved and will count down in minutes. Minute minder durations of less than 10 minutes will count down in seconds.

Deleting the minute minder duration

















- Select the minute minder in the display or select the  sensor control and then the desired minute minder duration.

The minute minder duration selected will appear.





- Select .
- Touch  to confirm.

The minute minder duration is now deleted.

Main and sub-menus

Menu	Recommended value	Range
Oven functions 		
Fan plus 	160 °C	30–250 °C
Microwave 	1000 W	80–1000 W
Conventional heat 	180 °C	30–250 °C
MW combi 	300 W	80–300 W
MW + Fan plus 	160 °C	30–220 °C
MW + Fan grill 	200 °C	100–200 °C
MW + Grill 	3	1–3
MW + Auto roast 	160 °C	100–200 °C
Intensive bake 	170 °C	50–220 °C
Auto roast 	160 °C	100–230 °C
Bottom heat 	190 °C	100–200 °C
Grill 	3	1–3
Fan grill 	200 °C	100–220 °C
Eco Fan heat 	190 °C	100–230 °C
Automatic programmes 		

Main and sub-menus

Menu	Recommended value	Range
Special applications 		
Defrost	–	–
Drying	60 °C	30–70 °C
Reheat	–	–
Heat crockery	80 °C	50–100 °C
Prove dough	35 °C	30–50 °C
Low temp. cooking	90 °C	80–120 °C
Sabbath programme	180 °C	30–250 °C
Keeping warm	75 °C	60–90 °C
MyMiele  		
User programmes 		
Settings 		

Microwave operation

How it works

The oven contains a magnetron that converts electrical energy into electromagnetic waves (microwaves). These microwaves are distributed evenly throughout the oven compartment, and are reflected off the metal appliance walls.

The microwaves penetrate inside the food from all sides. Food consists of many molecules. When subjected to microwave energy, these molecules (particularly the water molecules) start to oscillate. This heats the food from the outside to the inside. The more water a food contains, the faster it is reheated or cooked.

Advantages of the microwave oven

- Food can generally be cooked without having to add any/very much extra liquid or fat.
- The durations for defrosting, reheating or cooking are shorter than with a hob or oven.
- Vitamins, minerals, natural colour, and taste of the food are generally retained.

If the oven is used without food or the food is loaded incorrectly when using the Microwave  operating mode or operating modes that use microwave power, the oven can become damaged.

Always use the glass tray with the Microwave  operating mode, even if you use it as a container for smaller dishes.

Selecting crockery

In order for microwaves to reach the food, they must be able to penetrate the crockery being used. Microwaves can pass through porcelain, glass, cardboard and plastics, but not metal. Therefore, do not use metal containers or crockery that contains metal. Metal reflects the

microwaves which can create sparks and the microwaves are not absorbed by the metal.

 Risk of injury from increased pressure in closed containers or bottles. Pressure can build up during reheating in sealed containers or bottles, causing them to explode. Never cook or reheat solid or liquid food in sealed containers or bottles. Open containers beforehand. In the case of baby bottles, the screw top and teat must be removed.

 Fire hazard due to using unsuitable crockery for operating modes which use microwave power. Crockery which is not suitable for use in microwave ovens can be badly damaged and cause damage to the oven. Only use microwave-safe crockery for operating modes which use microwave power.

The material and shape of the crockery used affect the reheating and cooking durations.

Heat distribution is more even in round and oval-shaped shallow containers. Food is reheated more evenly in these containers than in square containers.

Suitable crockery

 Fire hazard due to inflammable materials. Disposable containers made out of plastic, paper or other inflammable materials can ignite, causing damage to the oven. Do not leave the oven unattended when reheating or cooking food in disposable containers made of plastic, paper or other inflammable materials.

Microwave operation

You can use the following crockery and materials:

- Heat-resistant glass and ceramic glass
Exception: crystal glass as it contains lead and may crack.
- Porcelain
 - Without metallic decoration
Metallic decoration (e.g. gold rims or cobalt blue) can cause sparking.
 - Without hollow knobs and handles
Moisture can gather in the hollow knobs and handles. When the moisture evaporates, pressure can build up and the item can explode.
- Unpainted stoneware and stoneware with underglaze paints

 Risk of injury caused by hot crockery.





Stoneware can get hot.

Wear oven gloves when using stoneware.

- Plastic containers and plastic disposable containers with the Microwave  operating mode

Tip: To protect the environment, avoid the use of disposable containers.

Plastics must be heat-resistant to a minimum of 110 °C. Otherwise the plastic may melt and fuse with the food. Only use plastic containers with the Microwave  function.

Do not use plastic containers with the MW + Auto roast , MW + Fan plus , MW + Grill  or MW + Fan grill  functions.

- Microwave-safe plastic containers
Special plastic containers designed for use in microwave ovens are available from retail outlets.





- Styrofoam containers
For briefly heating food
- Plastic boiling bags
For cooking and reheating. They should be pierced beforehand. The holes allow the steam to escape. This prevents a build-up of pressure from forming and the bag from bursting. There are also special bags available for steam cooking which do not need to be pierced. Please follow instructions given on the packet.
- Roasting bags and tubes
Please follow the manufacturer's instructions.

 Fire hazard due to metal parts.





Metal parts such as metal clips or plastic and paper ties that have wire running through them can heat inflammable materials until they burn.

Do not use metal clips or plastic and paper ties containing wire.

Tip: Metal tins are less suitable for operating modes which use microwave power because the metal reflects the microwaves. The microwaves only reach the cake from above, which extends the baking duration. If you use metal tins, place the tin on the glass tray so that it cannot touch the oven walls. If sparks form, do not reuse the tin for operating modes which use microwave power.

- The **supplied** rack is only suitable for cooking processes with the MW + Auto roast , MW + Fan plus , MW + Grill  and MW + Fan grill  operating modes as well as for operating modes which do not use microwave power (placed on one level).

Microwave operation

- Metal baking tins for baking with the MW + Auto roast , MW + Fan plus , MW + Grill  and MW + Fan grill  operating modes as well as for operating modes which do not use microwave power
- Aluminium foil trays without lids for defrosting and reheating ready meals. The food is only heated from the top. If you remove the food from the aluminium foil container and transfer it to crockery suitable for use in a microwave oven, the heat distribution will generally be more even.

Using aluminium foil trays and aluminium foil can cause crackling and sparks.

Therefore, place aluminum foil trays on the glass tray and not on the rack. Aluminium foil and aluminium foil trays must not touch the oven compartment walls and must remain at least 2 cm from the walls at all times.

- Metal meat skewers or clamps
The size of the cut of meat must be much larger than the metal skewers and clamps.

Unsuitable crockery

Crockery and lids with hollow handles or knobs can collect moisture in the hollow spaces. When the moisture evaporates, pressure can build up and the item can explode. If the hollow recess is sufficiently ventilated, the item can be used.

Do not use crockery with hollow knobs or handles for cooking.

Do **not** use the following crockery and material:

- Metal racks (including the supplied rack) are **not** suitable for use with the Microwave  operating mode.
- Metal containers
- Aluminium foil
Exception: for even defrosting, reheating or cooking of unevenly shaped cuts of meat, e.g. poultry, small pieces of aluminium foil may be used to cover thin parts for the last few minutes of the programme.
- Metal clips, plastic or paper ties containing wire
- Plastic containers where the aluminium lid has not been completely removed
- Crystal glass
- Cutlery and crockery with metallic decoration (e.g. gold rims, cobalt blue)
- Crockery with hollow handles
- Plasticware made of melamine
Melamine absorbs microwave energy and gets hot.
When purchasing plasticware, make sure that it is suitable for use in a microwave oven.
- Wooden dishes
Water contained in wood evaporates during the cooking process. This causes the wood to dry and crack.

Testing dishes

Unsuitable crockery can cause sparks or crackling noises. If you are not sure whether glass, porcelain or stoneware crockery is suitable, test the dishes.

This test cannot be used to check whether items with hollow knobs or handles are suitable for use.

Microwave operation

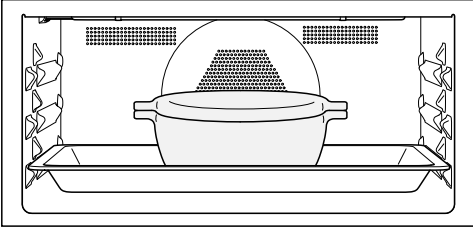

- Place the empty crockery in the middle of the glass tray and slide the tray into shelf level 1.
- Close the door.
- Select the Microwave  function.
- Set the highest microwave power level (1000 W) and a cooking duration of 30 seconds.
- Start the programme.
- Observe the crockery during the entire duration.
- Immediately open the door if there are sparks or crackling noises.

If there are sparks or if you can hear crackling noises, the tested crockery is not suitable for microwave use.

Cover

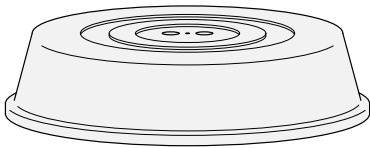



Tip: Covers are available from retail outlets.

- A cover prevents too much steam escaping, especially when reheating foods over a longer period of time.
- It speeds up the cooking process of the food.
- It prevents food from drying out.
- It helps keep the oven compartment clean.

- Use a glass or plastic cover suitable for microwave use for cooking processes with the Microwave  operating mode.





Alternatively, use a cling film suitable for use in a microwave oven. Heat can cause normal cling film to distort and fuse with the food.

The cover can withstand temperatures of up to 110 °C. At higher temperatures (e.g. in the Grill  or Fan plus  operating modes), the plastic may distort and fuse with the food.

Only use a cover for the Microwave  operating mode.

The cover should not form a seal with the container. If the container has a narrow diameter, the steam may not be able to escape. The cover could get too hot and start to melt.

Use containers with a sufficiently large diameter.

- Do **not** use a cover for reheating the following types of food:
 - Food coated in breadcrumbs
 - Food which requires a crisp finish, e.g. toast
 - Food which must be heated with the MW + Auto roast , MW + Fan plus , MW + Grill  or MW + Fan grill  operating modes

Operation

Placing food directly on the floor of the oven when using the Microwave  operating mode can damage the oven.

When using the Microwave  operating mode, place the glass tray on level 1 and **always** place cooking containers on the glass tray.

- Switch the oven on.

The main menu will appear.

- Place the food in the oven compartment.
- Select Oven functions .
- Select the operating mode you want to use.

The operating mode will appear in the display. Depending on the operating mode, the recommended power level, recommended temperature and the cooking duration will appear in the display.

- Change the recommended values for the cooking process and set the cooking duration if required.

You can change the recommended values later by selecting the relevant value or Timer.

- Touch *OK* to start the cooking process for operating modes which **do not use** microwave power.
- Touch *Start* to start the cooking process for operating modes which **use** microwave power.

The set values appear and the cooking process runs for all operating modes.

If you have set a temperature, you will see the temperature increasing. A buzzer will sound when the set temperature is reached for the first time.

The oven stops generating microwave power when you interrupt the cooking process with *Stop* or open the door. You can continue the cooking process with *Start*.

- After the cooking process, select *Finish* or *Close* (depending on the operating mode).
- Take the food out of the oven compartment.
- Switch the oven off.

Changing values and settings for a cooking programme

Depending on the function, as soon as a cooking programme is in progress, you can change the values or settings for this programme.

Depending on the function, you can change the following settings:

- Temperature
- Power level
- Duration
- Finish at
- Start at
- Booster
- Pre-heat
- Crisp function

Changing the temperature and core temperature

Go to *Settings* | *Recommended temps.* to permanently adjust the recommended temperatures to suit your cooking preferences.

The  core temperature only appears if you are using the food probe (see “*Roasting – Food probe*”).

- Touch the temperature display.

- Change the temperature and the  core temperature if necessary.
- Confirm with *OK*.

The cooking programme will restart with the new desired temperatures.

Changing the microwave power level

Go to Settings | Recomm. power levels to permanently set the recommended power level to suit your personal cooking preferences.

- Touch the microwave power level display.
- Change the microwave power level.
- Select Start.

The programme will restart with the new microwave power level.

Setting cooking durations

Cooking results can be impaired if there is a long delay between the food being placed in the oven and the start of cooking. Fresh food can change colour and even deteriorate. When baking, the cake mixture or dough can dry out, and the raising agents can lose their effectiveness. Select as short as possible a time until the cooking programme starts.

You have placed the food in the oven compartment, selected an operating mode and the required settings such as the temperature.

By entering Duration, Finish at or Start at, you can automatically switch the cooking process off or on and off.

- Duration
Enter the required cooking duration for the food. The heating will switch off automatically once this duration has

elapsed. The maximum cooking duration that can be set depends on the operating mode that you have selected.

- Finish at
Specify when you want the cooking process to end. The oven heating will switch off automatically at the time you have set.
- Start at
This function will only appear in the menu if you have set a Duration or Finish at time. With Start at, you have to specify when you want the cooking process to start. The oven heating will switch on automatically at the time you have set.
- Select  or Timer.
- Set the desired times.
- Confirm with *OK*.

Changing the set cooking durations

- Select , the duration or Timer.
- Select the desired time and change it.
- Confirm with *OK*.

These settings will be deleted in the event of a power failure.

Deleting the set cooking durations

- Select , the duration or Timer.
- Select the desired time.
- Select Delete.
- Confirm with *OK*.

If you delete Duration, the set times for Finish at and Start at are also deleted.

If you delete Finish at or Start at, the cooking programme will start using the cooking duration set.

Operation

Interrupting a cooking programme in the Microwave function

You can interrupt cooking when using the Microwave  function and pause the cooking duration.

While the cooking duration is counting down, Stop appears in the bottom right of the display.

■ Select Stop.

Cooking is interrupted and the cooking duration is paused.

Start is highlighted in green.

■ Select Start.

The cooking programme restarts and the cooking duration continues to count down.

Cancelling a cooking programme

If you cancel a cooking programme, the oven heating and lighting will switch off. Any cooking durations set will be deleted.

Cancelling a cooking programme without a set cooking duration

■ Select Finish.

The main menu will appear.

Cancelling a cooking programme with a set cooking duration

■ Select Cancel.

Cancel process? appears in the display.

■ Select Yes.

The main menu will appear.

Pre-heating the oven compartment

The Booster function is used to quickly pre-heat the oven compartment in some functions.



The Pre-heat function can be used with any function (except Microwave ) and has to be switched on separately for each cooking programme.

If you have set a cooking duration, it will only start to count down when the desired temperature is reached and you have placed the food in the oven.

It is only necessary to pre-heat the oven compartment in a few instances.

■ Place most dishes in the cold oven compartment to make use of the heat produced during the heating-up phase.





■ Pre-heat the oven compartment when cooking the following food with the following functions:

- Dark bread dough as well as beef sirloin joints and fillet with the Fan plus  and Conventional heat  functions
- Cakes and pastries with a short cooking duration (approx. 30 minutes or less) as well as delicate items (e.g. sponge) with the Conventional heat  function (without the Booster function)

Booster

The Booster function is used to quickly pre-heat the oven compartment.

This function is switched on as the factory default setting for the following functions (Settings | Booster | On):

- Fan plus 
- Conventional heat 
- Auto roast 
- MW + Fan plus 
- MW + Auto roast 

If you set a temperature above 100 °C and the Booster function is switched on, a rapid heating-up phase heats the oven to the set temperature. The top heat/grill element and the ring heater element come on together with the fan.

Delicate items (e.g. sponge or biscuits) will brown too quickly on the top if the Booster function is used. Switch off the Booster function for these items.

Switching the Booster on and off for a cooking programme

If you have selected the Booster | On setting, you can switch off the function separately for a cooking programme.

On the other hand, you can also switch on the function separately for a cooking programme if you have selected the Booster | Off setting.

Example: you have selected a function and the required settings such as the temperature.

You want to switch off the Booster function for this cooking programme.

- Drag down the pull-down menu.

Booster is highlighted in orange.

- Select Booster.

Depending on the colour scheme, Booster is highlighted either in black or white.

- Close the pull-down menu.

The Booster function is switched off during the heating-up phase. Only the heating elements associated with the function are pre-heating the oven compartment.

Pre-heat

It is only necessary to pre-heat the oven in a few instances.

You can place most dishes in the cold oven compartment to make use of the heat produced during the heating-up phase.

If you have set a cooking duration, it will only start to count down when the desired temperature is reached and you have placed the food in the oven. Start the cooking process immediately without delaying the start time.

The Pre-heat function is not available with the Microwave  operating mode.

Switching on Pre-heat

The Pre-heat function can be used with any operating mode and has to be switched on separately for each cooking programme.

Example: you have selected a function and the required settings such as the temperature.

You want to switch on the Pre-heat function for this cooking programme.

- Drag down the pull-down menu.

Operation

Depending on the colour scheme, Pre-heat is highlighted either in black or white.

- Select Pre-heat.

Pre-heat is highlighted in orange.

- Close the pull-down menu.

The following message is displayed with a time: Place food in the oven at . The oven compartment is heated to the set temperature.

- As soon as you are prompted to do so, place the food in the oven compartment.
- Confirm with *OK*.

Crisp function

It is a good idea to use the Crisp function (moisture reduction) when cooking food which has a moist topping e.g. quiche, pizza, tray bakes with fresh fruit toppings or muffins.

Poultry in particular gets a good crisp skin with this function.

Switching on Crisp function

The Crisp function can be used with any operating mode and has to be switched on separately for each cooking programme.

You have selected a function and the required settings such as the temperature.

You want to switch on the Crisp function for this cooking programme.

- Drag down the pull-down menu.

Depending on the colour scheme, Crisp function is highlighted either in black or white.

- Select Crisp function.

Crisp function is highlighted in orange.

- Close the pull-down menu.

The Crisp function is switched on.

Changing the function

You can change to another function during a cooking programme.

- Touch the symbol for the selected function.
- If you have set a cooking duration, confirm the *Cancel process?* message with *Yes*.
- Select the new function.

The new function appears in the display with its corresponding recommended values.

- Set the values for the cooking programme and confirm with *OK*.

These functions can only be used when no other cooking programmes are in use.

Always use the glass tray.

Quick MW

If you select the  sensor control, the microwave oven starts with a set microwave power level and cooking duration, e.g. to reheat a drink.

A microwave power level of 600 W and a maximum cooking duration of 1 minute are preset.

You can change the microwave power level and the cooking duration. The maximum cooking duration that can be set depends on the microwave power level selected (see “Settings – Quick MW”).

- Select the  sensor control. Touching the sensor control repeatedly increases the cooking duration in set stages.

The time left will appear in the display.

You can interrupt the cooking process at any time with Stop, or cancel it by selecting the  sensor control.

At the end of the cooking process, Finished appears on the display and a buzzer sounds.

- Select Close.

The main menu will appear.

Popcorn

If you select the  sensor control, the microwave oven starts with a set microwave power level and cooking duration.

A microwave power level of 850 W and a maximum cooking duration of 2:50 minutes are pre-set. These settings match the manufacturer’s instructions on most bags of microwave popcorn.

The maximum cooking duration that can be set is 4 minutes. The microwave power level is set and cannot be modified (see “Settings – Popcorn”).

- Select the  sensor control.

The time left will appear in the display.

You can interrupt the cooking process at any time with Stop, or cancel it by selecting the  sensor control.

Disposable containers made out of paper or other inflammable materials can ignite, causing damage to the oven.

Do not leave the oven unattended during the cooking process and make sure you follow the instructions on the packaging.

At the end of the cooking process, Finished appears on the display and a buzzer sounds.

- Select Close.

The main menu will appear.

Automatic programmes

The wide range of automatic programmes enables you to achieve excellent results with ease.

Categories

The  automatic programmes are sorted into categories to provide a better overview. Simply select the appropriate programme for the type of food you are cooking and follow the instructions in the display.

Using automatic programmes

- Select Automatic programmes .

A list will appear in the display.

- Select the desired food category.

The automatic programmes available for the food category selected will then appear.

- Select the desired automatic programme.
- Follow the instructions in the display.

Some automatic programmes and special applications will prompt you to use the food probe. Read the information under “Roasting – Food probe”.

The core temperature cannot be changed for the automatic programmes.

Tip: Use  Info to display information such as how to place or turn the food depending on the cooking programme.

Handy hints

- When using automatic programmes, the recipes provided are designed as a guide only. Other similar recipes, including those using different quantities, can be used for the automatic programme in question.
- After cooking, allow the oven compartment to cool down to room temperature again before starting an automatic programme.
- Some automatic programmes require a pre-heating phase before food is placed in the oven compartment. A prompt will appear in the display indicating when this needs to be done.
- Some automatic programmes require the addition of liquid after a certain cooking duration. You will be prompted by a message in the display when this needs to be done (e.g for adding liquid).
- The duration quoted for automatic programmes is an estimate. It may increase or decrease depending on the programme. The duration, in particular with meat, will vary depending on the initial temperature of the food.
- When using the food probe, the cooking duration will be determined by when the core temperature is reached.
- If by the end of an automatic programme the food is not cooked enough, select **Cont. cooking** or **Continue baking**. Conventional heating will then be used for 3 minutes to continue cooking or baking the food.

Search

(Depending on language)

Under Automatic programmes, you can search by the name of the categories and the automatic programmes.

There is a full text search function which can also be used to search for parts of words.

You are in the main menu.

- Select Automatic programmes .

The category list will appear on the display.

- Select Search.
- Use the keyboard to type in the search text, e.g. "Bread".

The number of hits will be shown in the footer.

If no match is found, or if there are more than 40 matches, the hits field is deactivated and you will need to change the search text.

- Select XX hits.

The categories and automatic programmes found will then appear.

- Select the desired automatic programme, or the category and then the desired automatic programme.

The automatic programme will start.

- Follow the instructions on the display.



Special applications

This section provides information on the following applications:

- Defrost
- Drying
- Reheat
- Heat crockery
- Prove dough
- Low temp. cooking
- Sabbath programme
- Keeping warm
- Cooking
- Frozen food/ready meals

Defrost

Gentle defrosting of frozen goods means that the vitamins and minerals are generally retained.

- Use one of the following functions and special applications:
 - Special applications  | Defrost
Select a category and the weight for the food.
 - Oven functions  | Microwave 
Set the microwave power level and the defrosting duration.

 Risk of infection from bacteria. Bacteria such as salmonella can cause life-threatening food poisoning. It is particularly important to observe food hygiene rules when defrosting fish and meat, and in particular when defrosting poultry. Do not use the liquid produced during defrosting. Process the food as required as soon as it has been defrosted.

Tips

- Place the frozen goods to be defrosted on the glass tray without their packaging.
- For defrosting poultry, use the glass tray with the rack placed on top of it. This way the frozen goods will not be lying in the defrosted liquid.
- Meat, poultry or fish does not need to be fully defrosted before cooking. Defrost until the food has started to thaw. The surface will then be sufficiently thawed to take herbs and seasoning.

Using the Defrost special application

This programme has been developed for gently defrosting frozen goods.

Use crockery that is microwave safe.

- Select Special applications .
- Select Defrost.

A list will appear in the display.

- Select the desired food category.
- Enter the weight of the frozen goods.

You can start the defrosting process immediately or delay the start and display the individual actions and cooking stages.

- Follow the instructions in the display.

Tips

- Use **i** Info to display information such as when to turn the frozen goods depending on the cooking programme.
- If the frozen goods are not defrosted properly by the end of the defrosting process, select **Cont keep warm**. The frozen goods will continue to be heated for 3 minutes.
- After the defrosting process has ended, select **Save** to save the settings for the selected category and weight as a User programme (see "User programmes").

Using the Microwave function

Instead of the special application, you can use the Microwave  function for defrosting. Set the microwave power level and the defrosting duration.



The time required depends on the nature of the food, its initial temperature and the amount to be cooked. Take note of the standing times.

Use crockery that is microwave safe.

- Select Oven functions .
- Select Microwave .
- Depending on the type of food, set the microwave power level and the defrosting duration specified in the table.
- You are generally advised to select the middle duration.
- Place the food on the glass tray on shelf level 1 in the oven compartment.

Special applications

Defrosting with the Microwave function

Food to be defrosted	Quantity	 [W]	 [min]	 [min]
Butter	250 g	80	8–10	5–10
Milk	1000 ml	450	12–16	10–15
Sponge cake (3 slices)	Approx. 300 g	150	4–6	5–10
Fruit cake (3 slices)	Approx. 300 g	150	6–8	10–15
Butter cake (3 slices)	Approx. 300 g	150	6–8	5–10
Cream cake (3 slices)	Approx. 300 g	80	4–4:30	5–10
Yeast buns, puff pastries (3 pieces)	Approx. 300 g	150	6–8	5–10

 Microwave power level,  defrosting duration,  standing time

¹ Allow food to stand at room temperature. This allows the heat to spread evenly throughout the food.





Drying

Dehydrating or drying is a traditional method of preserving fruit, certain vegetables and herbs.

It is important that fruit and vegetables are ripe and not bruised before they are dried.

- Prepare the food for drying by cutting it up, and peeling and coring it if necessary.
- Distribute the food for drying evenly in a single layer according to size over the wire rack or the glass tray.
- Dry on a maximum of 2 levels at the same time.
Place the food for drying on shelf levels 1+2.
If you are using both the wire rack and glass tray, insert the glass tray below the wire rack.
- Select Special applications .
- Select Drying.
- Alter the recommended temperature if necessary and then set the drying time.
- Follow the instructions on the display.
- Turn the food for drying on the glass tray at regular intervals.

The drying times are longer for whole or halved dried food.

Food for drying		🌡️ [°C]	🕒 [h]
Fruit		60–70	2–8
Vegetables		55–65	4–12
Mushrooms		45–50	5–10
Herbs*		30–35	4–8

 Special application/Operating mode,

🌡️ Temperature, 🕒 Drying time,

 Special application Drying,

 Operating mode Conventional heat

* Dry herbs only on the glass tray on shelf level 2 and use the Conventional heat  operating mode, as the fan is switched on in the Drying special application.

- Reduce the temperature if condensation begins to form in the oven compartment.

Removing the dried food

 Risk of injury caused by hot surfaces.

The oven gets hot during operation. You could burn yourself on the heating elements, oven compartment or accessories.

Use oven gloves when removing dried food from the oven.

- Allow the dried fruit or vegetables to cool down after drying.

Dried fruit needs to be completely dry, but also soft and elastic. Juice should not escape when cut.

- Store dried food in sealed glass jars or tins.

Special applications

Reheat

It is essential that the section entitled “Correct use” in the “Warning and safety instructions” is observed.

 Risk of injury caused by hot food.

If food for babies and children is reheated at too high a temperature, they can burn themselves.

Only heat food for babies and children for 30–60 seconds at 450 W. The food probe can be used to monitor the temperature when reheating.

After reheating food, especially food for babies and small children, stir the food or shake the container and taste the food so that children do not get burned.

 Risk of injury from increased pressure in closed containers or bottles.

Pressure can build up during reheating in sealed containers or bottles, causing them to explode.

Never cook or reheat food or liquids in sealed containers or bottles. Open containers beforehand. In the case of baby bottles, the screw top and teat must be removed.

Risk of injury caused by hot liquids. When heating food, and in particular liquids, using the Microwave  function, the boiling point may be reached without the production of typical bubbles. The liquid does not boil evenly throughout.

This boiling delay can result in the liquid boiling over explosively. Take care when taking the container out of the oven, as the hot liquid can cause severe scalding. Under certain circumstances, the pressure can be so high that the door opens automatically.

Stir liquids well before reheating or cooking.

After reheating, wait at least 20 seconds before removing the container from the oven compartment.

In addition, a glass rod or similar item, if available, can be placed in the container during reheating.

Using the Reheat special application

This programme is designed for reheating food.

The time required depends on the nature of the food, its initial temperature and the amount to be cooked. For example, food taken straight from the refrigerator takes longer to reheat than food which has been kept at room temperature. Take note of the standing times.

Use crockery that is microwave safe. Always cover food when reheating it, except when reheating meat/fish coated in breadcrumbs.

- Place the food that is to be reheated in the glass tray with a cover.
- Select Special applications .
- Select Reheat.

A list will appear in the display.

- Select the desired food category.
- Enter the weight of the food.
- Follow the instructions in the display.

 Danger of burning due to hot surfaces.

The oven gets hot during operation. You could burn yourself on the heater elements, oven compartment or accessories. Droplets of water may have accumulated underneath the crockery.

Use oven gloves when working in the hot oven compartment and when removing the crockery.

During the standing time, the temperature is distributed evenly in the food.



- After reheating, allow the food to stand at room temperature for a few minutes to enable the heat to spread evenly throughout the food.

Tips

- Always cover food when reheating it, except when reheating meat/fish coated in breadcrumbs.
- Use  Info to display information such as when to turn or stir the food. Stir the food from the outside towards the middle, as food heats more quickly from the outside.
- If the food is not hot enough at the end of the programme, select **Cont keep warm**. The food will continue to be heated for 3 minutes.
- After the programme has ended, select **Save** to save the settings for the selected category and weight as a User programme (see “User programmes”).

Special applications

Reheating with the Microwave function

Drink/ food	Quantity	 [W]	 [min]	 ¹ [min]
Drinks (drinking temperature 60–65 °C)	1 cup/1 glass (200 ml)	1000	00:50–1:10	–
Baby bottle (milk) ²	Approx. 200 ml	450	00:50–1:00 ³	1
Food for babies and children ³	1 jar (200 g)	450	00:30–1:00	1
Sliced meat with sauce ³	200 g	600	3:00–5:00	1
Side dishes ³	250 g	600	3:00–5:00	1

 Microwave power level,  Cooking duration,  Standing time

- ¹ Allow food to stand at room temperature. This allows the heat to spread evenly throughout the food.
- ² A boiling delay can be avoided by stirring liquids before reheating them. After reheating, wait at least 20 seconds before removing the container from the oven compartment. In addition, a glass rod or similar item, if available, can be placed in the container during reheating.
- ³ The durations apply to food with an initial temperature of approx. 5 °C. For food not normally refrigerated, durations apply to food at room temperature or approx. 20 °C. With the exception of baby food and delicate whisked sauces, food should be reheated to a temperature of 70–75 °C.

Heat crockery

By pre-heating the crockery, the food does not cool down as quickly.

Use heat-resistant crockery.

- Place the rack on shelf level 1 and place the crockery to be warmed on it. Depending on the size of the crockery, you can also place the rack on the oven floor.
- Select Special applications .
- Select Heat crockery.
- Alter the recommended temperature if necessary and then set the time.
- Follow the instructions in the display.



Risk of injury caused by hot surfaces.

The oven gets hot during operation. You could burn yourself on the heating elements, oven compartment or accessories. Droplets of water may have accumulated underneath the crockery.

Use oven gloves when removing the crockery from the oven.

Prove dough

This programme is designed specifically for proving yeast dough.

- Select Special applications .
- Select Prove dough.
- Alter the recommended temperatures if necessary and then set the duration.
- Follow the instructions in the display.

Keeping warm

You can keep food warm in the oven compartment for several hours.

In order to maintain the quality of food, select the shortest possible time.

- Select Special applications .
- Select Keeping warm.
- Place the food to be kept warm in the oven compartment and confirm with *OK*.
- Alter the recommended temperature if necessary and then set the time.
- Follow the instructions in the display.

Special applications

Low temp. cooking

The Low temp. cooking cooking method is ideal for cooking beef, pork, veal or lamb when a tender result is desired.

First sear the meat all over at a high temperature on the hob in order to seal it.

Then place the meat in the pre-heated oven compartment where the low temperature and long cooking duration will cook it to perfection and ensure it is very tender.

The meat will relax. The juices inside will start to circulate evenly throughout the meat to reach the outer layers.

This gives very tender and succulent results.

- Only use lean meat which has been correctly hung and trimmed. Bones must be removed before cooking.
- For searing, use a suitable cooking oil or fat that can withstand high temperatures (e.g. clarified butter, vegetable oil).
- Do not cover meat during the cooking process.

The cooking duration takes approx. 2–4 hours depending on the weight and size of the meat and how well you want it cooked.

- As soon as the cooking process is done, you can carve the meat straight from the oven. It does not need to rest.
- The meat can be left in the oven compartment to keep warm until you serve it. This will not affect results in any way.
- Serve on pre-heated plates with very hot sauce or gravy to prevent it cooling down too quickly. The meat is at the ideal temperature for eating straight away.

Using the Low temp. cooking special application

Observe the information under “Roasting – Food probe”.

- Select Special applications .
- Select Low temp. cooking.
- Follow the instructions in the display. Place the necessary accessories in the oven compartment for the pre-heating phase.
- Set the temperature and the core temperature.
- Whilst the oven compartment is pre-heating, sear the meat thoroughly on all sides on the hob.

 Danger of burning due to hot surfaces.

The oven gets hot during operation. You could burn yourself on the heating elements, oven compartment or accessories.

Use oven gloves when placing food in the oven or removing it and when working in the hot oven compartment.



- As soon as Insert food probe and place food in the oven appears in the display, place the seared meat on the rack and insert the metal tip of the food probe fully into the centre of the meat.
- Close the door.

At the end of the programme, Finished appears in the display and a buzzer sounds.

Using the Conventional heat operating mode

Follow the information in the cooking charts at the end of this book.

Use the glass tray with the wire rack placed on top of it.
Switch off the Booster function for the pre-heating phase.

- Place the glass tray with a rack on shelf level 1.
- Select Oven functions .
- Select the Conventional heat  operating mode and a temperature of 100 °C.
- Switch off the Booster function via the pull-down menu.
- Pre-heat the oven compartment together with the glass tray and the wire rack for approx. 10 minutes.
- Whilst the oven is pre-heating, sear the meat thoroughly on all sides on the hob.

 Risk of burns due to hot surfaces. The oven gets hot during operation. You could burn yourself on the heater elements, oven compartment or accessories.

Use oven gloves when placing hot food in the appliance or removing it and when working in the hot oven compartment.

- Place the seared meat on the wire rack.
- Reduce the temperature if necessary (see “Cooking charts”).
- Continue cooking the meat until it is done.

Sabbath programme

The special applications Sabbath programme and Yom-Tov help to support religious observance.

Follow the instructions in the display to comply with Sabbath law requirements.

The oven heats up to the temperature you have set and maintains this temperature for a maximum of 24 hours (Sabbath programme) or 76 hours (Yom-Tov). In both special applications, the oven switches off automatically after 76 hours.

- Turn off furniture front detection.
- Place the food in the oven compartment.
- Select Special applications .
- Select Sabbath programme.
- Select the special application you want (Sabbath programme or Yom-Tov).

You will not be able to start the special application if you have set a minute minder or alarm.

Once a special application has started, it cannot be changed or saved under User programmes.

In case of a power failure, the special application will be cancelled. The oven will only remain in a sabbath-compliant state as long as the power has not been restored. Once the power has been restored, Power cut -process cancelled appears on the display.

Special applications

Using Sabbath programme

This special application is fit for use on the weekly Sabbath (Shabbat) and will allow you to heat food in the oven for up to 24 hours, until after the first door opening.

- Set the temperature.
- Select Start.

Sabbath programme and the set temperature appear on the display.

The oven heating switches on around 30 seconds after you have closed the door. The oven interior lighting remains switched on during the entire cooking process.

The time of day does not appear. The movement sensor does not respond, and neither do any of the sensor controls (except for the On/Off  sensor control).

Sabbath – do not open the door appears. After around 45 minutes, this warning switches off and reappears from time to time.

When this warning is **not** shown, the oven is not heating and you can open and close the door. Once you have opened the door, the oven heating **will remain switched off** until the end of the special application. If you leave the door closed until the end of the special application, the oven heating will switch off after 24 hours. The oven will remain switched on.

- If you want to end the special application prematurely, switch off the oven using the On/Off  sensor control.

At the end of the special application, Sabbath – do not open the door

disappears and the oven heating switches off. The display does not change until the oven switches off automatically after 76 hours.

Using Yom-Tov

This special application is fit for use on the weekday festivals and will allow you to heat food in the oven for up to 76 hours. During this time, you can open and close the door several times.

- Set the temperature.
- Select Start.

Yom-Tov and the set temperature appear on the display.

The oven heating switches on around 30 seconds after you have closed the door. The oven interior lighting remains switched on during the entire cooking process.

The time of day does not appear. The movement sensor does not respond, and neither do any of the sensor controls (except for the On/Off  sensor control).

Sabbath – do not open the door appears. After around 45 minutes, this warning switches off and reappears from time to time.

When this warning is **not** shown, you can open and close the door several times. The oven heating **will remain switched on**.

- If you want to end the special application prematurely, switch off the oven using the On/Off  sensor control.

The oven heating remains switched on until the end of the special application. The oven switches off automatically after 76 hours.

Cooking

It is essential that the section entitled “Correct use” in the “Warning and safety instructions” is observed.

Food with a thick skin or peel, such as tomatoes, sausage, potatoes and aubergines can burst when reheated or cooked.

Pierce or score the skin of these types of food several times to allow steam to escape.

Eggs reheated in their shells can burst, even after they have been taken out of the oven compartment.



Eggs can only be cooked in their shells in a specially designed egg-boiling device. Do not reheat hard boiled eggs using the Microwave  function.

If possible, use the food probe to monitor the temperature when cooking (see “Roasting – Food probe”).

Set the core temperature:





- Fish: at least 70 °C
- Poultry: at least 85 °C

Tips

- Turn, separate or stir the food several times. Stir the food from the outside towards the middle, as food heats more quickly from the outside.
- Use only crockery that is suitable for use in a microwave and oven when using functions which use microwave power.
- If possible, use the automatic programmes for cooking.
- Never use a lid with the MW + Fan grill  and MW + Grill  functions, as the food will not brown.
- With the Microwave  function, select a microwave power level of 850 W to start cooking, and then continue cooking at 450 W. Observe the information in the cooking charts at the end of this book.

Special applications

Cooking with the Microwave function

Soups/stews Vegetables	 [g]	 850 W [min]	+	 450 W [min]	 ¹ [min]
Stew	1500	10	+	20	1
Soup	1500	11	+	24	1
Peas	500	5	+	10	2
Peas (frozen)	450	5	+	12	2
Carrots	500	5	+	10	2
Broccoli florets	500	6	+	8	2
Broccoli (frozen)	450	5	+	11	2
Cauliflower florets	500	6	+	10	2
Kohlrabi batons	500	3	+	8	2
Asparagus	500	5	+	8	2
Leeks	500	5	+	8	2
Leeks (frozen)	450	5	+	8	2
Sliced peppers	500	5	+	10	2
Beans, green	500	4	+	12	2
Brussels sprouts	500	5	+	12	2
Brussels sprouts (frozen)	450	5	+	10	2
Mixed vegetables (frozen)	450	5	+	12	2

 Weight,  cooking duration,  standing time

¹ Allow food to stand at room temperature. This allows the heat to spread evenly throughout the food.

Frozen food/Ready meals

Tips for cakes, pizza and baguettes

- Bake cakes, pizza and baguettes on baking paper on the rack.
- Use the lowest temperature recommended on the packaging.

Tips for french fries, croquettes and similar items

- Bake these frozen products on baking paper in the glass tray.
- Use the lowest temperature recommended on the packaging.
- Turn the food several times during baking.

Preparing frozen food/ready meals

Handling food carefully will help protect your health.

Cakes, pizzas and french fries should be cooked until golden, not dark brown.

- Select the function and temperature recommended on the packaging.
- Pre-heat the oven compartment.
- Place the food in the pre-heated oven compartment on the shelf level recommended on the packaging.
- Check the food at the end of the shortest cooking duration recommended on the packaging.

MyMiele



Under MyMiele  , you can save frequently used applications.

It is particularly useful with automatic programmes as you do not need to work through every menu level in order to start your programme.





Tip: You can also set menu options that you have entered in MyMiele as your start screen (see “Settings – Start screen”).

Adding entries

You can add up to 20 entries.

- Select MyMiele  .
- Select Add entry.

You can select options listed in the following categories:



- Oven functions 
- Automatic programmes 
- Special applications 
- User programmes 

- Confirm with *OK*.

The selected item and its respective symbol will appear in the list.



- Proceed as described for further entries. You can only choose options that have not already been selected.

Deleting entries

- Select MyMiele  .
- Touch the entry you want to delete and keep your finger on it until the context menu appears.
- Select Delete.

The entry will then be removed from the list.

Moving entries

- Select MyMiele  .
- Touch the entry you want to move and keep your finger on it until the context menu appears.
- Select Move.

An orange border appears around the entry.

- Move the entry.

The entry appears in the desired position.

You can create and save up to 20 User programmes.

- You can combine up to 9 cooking stages to accurately programme your favourite or most frequently used recipes. In each cooking stage, you can select settings such as the function, temperature and cooking duration.
- You can specify the shelf level(s) for the food.
- You can enter the name of the programme for your recipe.

When you call up and start your programme again, it will run automatically.

There are different ways of creating a User programme:

- At the end of an automatic programme, save it as a User programme.
- Save a cooking programme after running it with a set cooking duration.

Then enter a programme name.

Creating User programmes

- Select User programmes .
- Select Create prog..

You can now specify the settings for the first cooking stage.

Follow the instructions in the display:

- Select and confirm the desired settings.

If you select the Pre-heat function, use Add to add another cooking stage where you set a cooking duration. Only then can you save or start the programme.

The settings for the first cooking stage have now been set.

You can add more cooking stages, for example, if you want to add another cooking function to follow on from the first.

- If additional cooking stages are required, select Add and proceed as for the first cooking stage.
- When you have finished setting all the cooking stages, select Set shelf level.
- Select the desired level(s).
- Confirm with *OK*.

If you want to check the settings or to change them at a later date, touch the cooking stage in question.

- Select Save.
- Enter the programme name using the keyboard.

You can add a line break for longer programme names using the  symbol.

- Once you have entered the programme name, select Save.

A message will appear in the display confirming that the programme name has been saved.

- Confirm with *OK*.

You can start the saved programme immediately, delay the start or change the cooking stages.

User programmes

Starting User programmes

- Place the food in the oven compartment.
- Select User programmes .
- Select the desired programme.

Depending on the programme settings, the following menu options appear in the display:

- Start now
The programme will start immediately. The oven heating will switch on immediately.
 - Finish at
Specify the time when you want the programme to stop. The oven heating will switch off automatically at the time you have set.
 - Start at
Specify the time when you want the programme to start. The oven heating will switch on automatically at the time you have set.
 - Display cooking stages
A summary of your settings will appear in the display.
 - Display actions
The required actions, e.g. placing the food in the oven, will appear in the display.
- Select the desired menu option.
 - Confirm the message regarding which shelf level to place the food with *OK*.

The programme selected will begin straight away or at the time set.

Use  Info to display information such as how to place or turn the food depending on the cooking programme.

- At the end of the programme, select Close.

Changing cooking stages

Cooking stages in automatic programmes that have been saved under a different name cannot be changed.

- Select User programmes .
- Touch the programme you want to change and keep your finger on it until the context menu appears.
- Select Change.
- Select the cooking stage that you want to change or *Add* to add another cooking stage.
- Select and confirm the desired settings.
- If you want to start the modified programme without changing it, select *Start*.
- Select *Save* when you have changed all the settings.

A message will appear in the display confirming that the programme name has been saved.

- Confirm with *OK*.

The saved programme has been changed and you can start it immediately or delay the start.

Renaming User programmes

- Select User programmes .
- Touch the programme you want to change and keep your finger on it until the context menu appears.
- Select Rename.
- Change the programme name using the keyboard.

You can add a line break for longer programme names using the `↵` symbol.

- Once you have changed the programme name, select Save.

A message will appear in the display confirming that the programme name has been saved.

- Confirm with *OK*.

The programme has now been renamed.

Deleting User programmes

- Select User programmes .
- Touch the programme you want to delete and keep your finger on it until the context menu appears.
- Select Delete.
- Confirm the query with Yes.

The programme will be deleted.

Go to Settings | Factory default | User programmes to delete all User programmes at the same time.

Moving User programmes

- Select User programmes .
- Touch the programme you want to move and keep your finger on it until the context menu appears.
- Select Move.

An orange border appears around the entry.

- Move the programme.

The programme appears in the desired position.

Baking

Handling food carefully will help protect your health.
Cakes, pizzas and french fries should be cooked until golden, not dark brown.

Tips on baking

- Set a cooking duration. If used for baking, do not delay the start for too long. Cake mixture or dough will dry out, and the raising agents will lose their effectiveness.
- Avoid using bright, thin-walled tins as they give an uneven or poor browning result. In some cases the food does not cook properly.
- Position rectangular tins with the longer side across the width of the oven compartment for optimum heat distribution and even baking results.
- Line the glass tray with baking paper before placing french fries, croquette potatoes and similar types of food on it.

Notes on the cooking charts

You can find the cooking charts at the end of this book.

Selecting the temperature

- As a general rule, select the lower temperature given in the chart. Baking at temperatures higher than those recommended may reduce the cooking duration, but will lead to uneven browning of the food, and unsatisfactory cooking results.

Selecting the cooking duration

Unless otherwise stated, the cooking durations given in the cooking charts are for an oven compartment which has not been pre-heated. With a pre-heated oven compartment, shorten times by around 10 minutes.

- As a general rule, check the food after the shortest duration. Stick a wooden skewer into the food.

If it comes out clean without any batter/dough on it, the food is done.

Notes on the functions

You can find an overview of all the functions with their recommended values in “Main and sub-menus”.

Using Automatic programmes

- Follow the instructions in the display.

Using Fan plus

You can use any type of baking tray made of heat-resistant material.

Because the fan distributes the heat around the oven compartment straight away, it allows you to use a lower temperature than you would with the Conventional heat  function.

Use this function if you are baking on several levels at the same time.

- 1 shelf level: place cakes in baking tins on shelf level 1.
- 1 shelf level: place flat items (e.g. biscuits, tray cakes) on shelf level 2.
- 2 shelf levels: depending on the height, place the food on shelf levels 1+3 or 2+3.

Using Conventional heat

Dark metal, enamel, tin or aluminium baking tins with a matt finish, as well as heat-resistant glass and coated tins can be used.

Use this function for baking traditional recipes. If using an older recipe or cookbook, set the oven temperature 10 °C lower than the recommended one. This will not change the cooking duration.

- Place cakes in baking tins on shelf level 1.
- Place flat items (e.g. biscuits, tray cakes) on shelf level 2.

Using Intensive bake

You can use any type of baking tray made of heat-resistant material.

Use this function for baking cakes with moist toppings.

Do **not** use this function for baking thin biscuits.

- Place cakes in baking tins on shelf level 1.

Using Eco Fan heat

You can use any type of baking tray made of heat-resistant material.

Use this function for cooking bakes and gratins that need to be crispy on top.

- Place cakes or bakes in baking tins on shelf level 1.
- Place flat items (e.g. biscuits, tray cakes) on shelf level 2.

Using MW + Fan plus

Use heat-resistant baking tins suitable for microwave use (see the requirements specified for crockery in the section on microwave operation), such as heat-resistant glass or ceramic dishes, as these allow microwaves through them.

The MW + Fan plus  function is particularly suitable for dough which requires a longer cooking duration, such as rubbed in, beaten mixtures and yeast recipes.

If you use this function, the cooking duration is shortened.

When selecting the microwave power level, observe the information in the cooking charts and in the recipes.

- Place the glass tray on shelf level 1.
- Place the baking tin on the glass tray.

Tip: Metal tins are less suitable for functions which use microwave power because the metal reflects the microwaves. The microwaves only reach the cake from above, which extends the cooking duration. If you use metal tins, place the tin on the glass tray so that it cannot touch the oven walls. If sparks form, do not reuse the tin for functions which use microwave power.

Roasting

Tips for roasting

- **Pre-heating** the oven compartment is only required when roasting beef sirloin joints and fillet. Pre-heating is generally not necessary.
- Use a **closed roasting dish** for roasting meat, such as an oven dish. The meat stays succulent. The oven compartment will also stay cleaner than when roasting on the rack. This ensures that sufficient stock remains for making gravy.
- If you are using a **roasting bag**, follow the instructions on the packaging.
- If you are using the **rack** or an **open roasting dish** for roasting, you can add a little fat or oil to very lean meat or place a few strips of streaky bacon on the top.
- **Season** the meat and place in the roasting dish. Dot with butter or margarine or brush with oil if necessary. For large lean cuts of meat (2–3 kg) and fatty poultry add about 1/8 l of water to the dish.
- Do not add too much liquid during cooking as this will hinder the **browning** process. Browning only occurs towards the end of the cooking duration. Remove the lid about halfway through the cooking duration if a more intensive browning result is desired.
- At the end of the programme, take the food out of the oven compartment, cover it and leave to **stand** for about 10 minutes. This helps retain juices when the meat is carved.
- For a crisp finish, baste **poultry** 10 minutes before the end of the cooking duration with slightly salted water.

Notes on the cooking charts

You can find the cooking charts at the end of this book.

- Take note of the temperature range, microwave power levels, shelf levels and durations. These also take the type of cooking container, the size of the meat and cooking practices into account.

Selecting the temperature

- As a general rule, select the lower temperature given in the chart. If higher temperatures are used, the meat will brown on the outside, but will not be properly cooked through.
- For cuts which weigh more than 3 kg, select a temperature approx. 10 °C lower than that given in the roasting chart. The roasting process will take longer, but the meat will cook evenly through and the skin or crackling will not be too thick.
- When roasting on the rack, set a temperature approx. 20 °C lower than for roasting in a covered oven dish.

Selecting the cooking duration

Unless otherwise stated, the durations given in the cooking chart are for an oven compartment which has not been pre-heated.

- The traditional British method for calculating the roasting time is to allow 15 to 20 minutes per lb/450 grammes, according to type of meat, plus approx. 20 minutes, adjusting the length of time as roasting proceeds to obtain the required result. The roasting time can also be determined by multiplying the thickness of the roast [cm] with the time per cm [min/cm] stated below, depending on the type of meat:
 - Beef/venison: 15–18 min/cm
 - Pork/veal/lamb: 12–15 min/cm
 - Sirloin/fillet: 8–10 min/cm
- As a general rule, check the food after the shortest duration.

Tips

- For frozen meat, increase the cooking duration by approx. 20 minutes per kg.
- Frozen meat weighing less than approx. 1.5 kg does not need to be defrosted before roasting.

Notes on the functions

You can find an overview of all the functions with their recommended values in “Main and sub-menus”.

Use the Bottom heat  function towards the end of the cooking duration to brown the base of the food.



Do not use the Intensive bake  function for roasting as the juices will become too dark.

Using Automatic programmes

- Follow the instructions in the display.

Using Fan plus or Auto roast

These functions are suitable for roasting meat, fish and poultry that needs to be well browned as well as sirloin joints and fillet.

The Fan plus  function allows you to use a lower temperature than you would with the Conventional heat  function, because the heat is immediately distributed around the oven compartment.

In the Auto roast  function, the oven compartment heats initially to a high searing temperature (approx. 230 °C). As soon as this temperature has been reached, the oven automatically drops the temperature back down to the pre-selected roasting temperature (continued roasting).

- For roasting, use crockery with heat-resistant handles such as an oven dish, roasting pan, Römertopf or a heat-resistant glass dish.
- Place the rack with the food on shelf level 1.

Using MW + Fan plus or MW + Auto roast

These functions are **not** suitable for roasting delicate cuts of meat such as sirloin joints or fillet. The centre would be too well cooked before the exterior is browned.

Use the MW + Fan plus  function for rapid reheating and cooking of food, browning it at the same time. This function saves the most time and energy.

Use the MW + Auto roast  function for searing using a high temperature to start with, then continue cooking with a lower temperature.

If you use functions which use microwave power, the cooking duration is shortened.

When selecting the microwave power level, observe the information in the cooking charts and in the recipes.

- Dishes must be suitable for use in a microwave oven, must be heat-resistant and must not have metal lids (see “Suitable crockery for microwave use”).
- Place the rack together with the glass tray or the glass tray on shelf level 1.

Roasting

Food probe

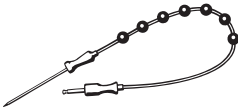

The food probe enables precise temperature-controlled roasting.

How it works

The metal tip of the food probe must be fully inserted into the centre of the food all the way to the handle. There is a temperature sensor in the metal tip which measures the core temperature of the food during cooking. The rise in the core temperature of the food reflects the progress of cooking. Set a lower or higher core temperature, depending on whether you want your roast to be medium or well done.







The core temperature can be set up to 99 °C. Information on food and respective core temperatures can be found in the cooking charts at the end of this book.

The cooking duration will be similar when cooking with or without the food probe.

When to use the food probe

Some automatic programmes and special applications will prompt you to use the food probe.

You can also use the food probe with User programmes and with the following functions:

- Auto roast 
- Fan plus 
- Conventional heat 
- Microwave 
- MW + Auto roast 
- MW + Fan plus 

Important usage notes

- You can place the meat in a pot, on the rack or in the glass dish, depending on the function selected.
- The metal tip of the food probe must be fully inserted into the centre of the food so that the temperature sensor reaches more or less to the core.
- When cooking poultry, insert the metal tip into the thickest part of the breast. Press the breast with your index finger and thumb to find the thickest part.
- The metal tip must not touch any bone or be inserted in areas with a lot of fat. Heavily marbled areas and bones can cause cooking to end prematurely.
- If the meat is very heavily marbled with fat, select the highest core temperature given in the cooking charts.
- When using aluminium foil or roasting bags, insert the food probe through the foil/bag into the centre of the food. You can also place meat inside the bag or foil with the food probe already inserted. Follow the roasting bag manufacturer's instructions.

Using the food probe

- Insert the metal tip of the food probe completely into the centre of the food all the way to the handle.

If you are cooking several pieces of meat at the same time, insert the food probe into the largest piece of meat.

- Place the food in the oven compartment.

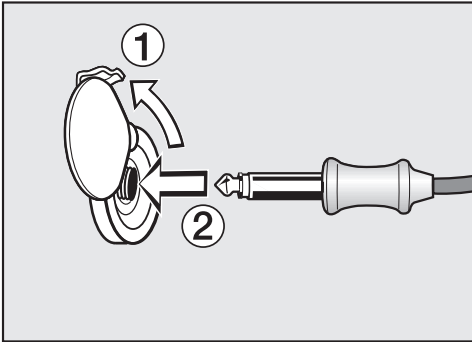

- Insert the plug of the food probe into the socket until you feel it engage.
- Close the door.
- Select the function or automatic programme.
- Set the temperature and the core temperature if necessary.

The core temperatures cannot be changed for the automatic programmes.
Follow the instructions on the display.

The cooking programme is brought to an end as soon as the core temperature is reached.

⚠ Risk of injury caused by hot surfaces.
The food probe can get hot. You could burn yourself on it.
Wear oven gloves when removing the food probe from its socket.

Delaying the start of a cooking programme with food probe

You can set the cooking programme to start at a later time.

- Select Start at.

The finish time can be calculated approximately because the duration of a cooking programme is about the same, whether or not the food probe is used.

You cannot set Duration and Finish at because the total cooking duration is determined by when the set core temperature is reached.

Time left display

If the temperature set for a cooking programme is above 140 °C, the estimated time left will appear in the display.

The time left is calculated from the cooking temperature selected, the set core temperature, and the progress of the core temperature as it rises.

The time left first shown is an estimate. As the cooking process continues, the time left is revised continuously, and a more accurate figure is shown.

The time left will be deleted if the cooking or core temperature is changed or if a different function is selected. If the door is opened for a longer time, the time left will be recalculated.

Grilling



Risk of injury caused by hot surfaces.

If you grill with the door open, hot air will escape from the oven instead of being cooled by the cooling fan. The control elements will get hot.

Grill with the oven door closed.

Tips for grilling

- Pre-heating is necessary when grilling. For pre-heating, select a function which **does not use** microwave power.
Pre-heat the top heat/grill element for approx. 5 minutes with the door closed.
- Trim the meat. Do not season the meat with salt before grilling as this draws the juices out.
- Add a little oil to lean meat if necessary. Do not use other types of fat as they can easily burn and cause smoke.
- Clean fish in the normal way. To enhance the flavour, season with a little salt. Fish can also be drizzled with lemon juice.
- Grill on the rack.
- To grill, brush the rack with oil and then place the food on the rack.

Notes on the cooking charts

You can find the cooking charts at the end of this book.

- Take note of the temperature range, the shelf levels and the durations. These take the size of the meat and cooking practices into account.
- Check the food after the shortest duration quoted.

Selecting the temperature

Select the temperature for the Fan grill  and MW + Fan grill  functions.

- As a general rule, select the lower temperature given in the chart. If higher temperatures are used, the meat will brown on the outside, but will not be properly cooked through.

Selecting the grill level

Select between levels 1–3 for the Grill  and MW + Grill  functions.

- If you are grilling thicker foods further away from the grill element, select **Level 1**.
- If you desire a lighter, golden finish, on gratins for example, select **Level 2**.
- If you are quickly grilling thinner foods closer to the grill element, select **Level 3**.

Selecting the cooking duration

- Grill thinner cuts of meat/slices of fish for approx. 6–8 minutes per side. It is best to grill food of a similar thickness at the same time so that the cooking duration does not vary too much.
- Grill thicker pieces for about 7–9 minutes per side.
- When grilling rolled meat, allow approx. 10 minutes per cm diameter.
- As a general rule, check the food after the shortest duration.
- To **test the food**, press down on the meat with a spoon. This lets you determine how well the meat has been cooked.
 - **Rare/rosé**
If the meat gives easily to the pressure of the spoon, it will still be red on the inside.
 - **Medium**
If there is some resistance, the inside will be pink.
 - **Well-done**
If there is very little resistance, it is cooked through.

Tip: If the surface of a thicker cut of meat is browned but the centre is still raw, move the food to a lower level or reduce the temperature and continue grilling. This will stop the surface from becoming too dark.

Notes on the functions

You can find an overview of all the functions with their recommended values in “Main and sub-menus”.

The plastic on the food probe can melt at very high temperatures. Do not use the food probe when using the grill functions. Do not store the food probe in the oven compartment when it is not being used.

If you use functions which use microwave power, the cooking duration is shortened.

When selecting the microwave power level, observe the information in the grilling charts and in the recipes.

Using Fan grill or MW + Fan grill

These functions are suitable for grilling thicker food, such as chicken.

A temperature setting of 220 °C is generally recommended for thinner types of food, 180–200 °C for thicker cuts.

- Place the rack on shelf level 1 or 2 depending on the height of the food.

Using Grill or MW + Grill

These functions are suitable for grilling thin cuts of meat and browning food.

- Place the rack on shelf level 2 or 3 depending on the height of the food.

Cleaning and care

 Risk of injury caused by hot surfaces.

The oven gets hot during operation. You could burn yourself on the heating elements, oven compartment or accessories.

Allow the heating elements, oven compartment and the accessories to cool before manual cleaning.

 Risk of injury due to electric shock.

The steam from a steam cleaning appliance could reach live electrical components and cause a short circuit.

Do not use a steam cleaner to clean the oven.

All surfaces could be discoloured or damaged if unsuitable cleaning agents are used. The oven front is particularly susceptible to damage from oven cleaners.

All surfaces are susceptible to scratching. Scratches on glass can in some circumstances lead to breakage.

Remove all cleaning agent residues immediately.

Stubborn soiling could damage the oven in certain circumstances.

Once the oven has cooled, clean the oven compartment, the inside of the door and the door seal. Waiting too long can make cleaning unnecessarily difficult and in some cases impossible.

Operating a damaged oven can result in microwave leakage and present a hazard to the user.

Check the door and door seal for any sign of damage. If any damage is noticed, the oven should not be used again with microwave functions until the fault has been rectified by a service technician.

Unsuitable cleaning agents

To avoid damaging the surfaces, do not use:

- Cleaning agents containing soda, ammonia, acids or chlorides
- Cleaning agents containing descaling agents on the front
- Abrasive cleaning agents (e.g. powder cleaners, scouring milk, scouring pads)
- Solvent-based cleaning agents
- Stainless steel cleaners
- Dishwasher cleaning agents
- Glass cleaning agents
- Cleaning agents for ceramic glass hobs
- Hard, abrasive brushes or sponges (e.g. pot scourers, brushes or sponges which have been previously used with abrasive cleaning agents)
- Stain remover eraser blocks
- Sharp metal scrapers
- Steel wool
- Spot cleaning with mechanical cleaning agents
- Oven cleaners *
- Stainless-steel spiral pads

* These can, however, be used to remove very heavy soiling from PerfectClean treated surfaces

If soiling is left on for any length of time, it may become impossible to remove. If items are used frequently without being cleaned, it may become very difficult to clean them. It is therefore best to remove any soiling immediately.

Only the glass tray is dishwasher proof.

Tip: Soiling caused by spilt fruit juices and cake mixtures is best removed while the oven compartment is still warm.

To make it easier to clean the oven:

- Lower the top heat/grill element.
- To neutralise odours in the oven compartment, put a container of water with some lemon juice in the oven and heat for a few minutes.

Removing normal soiling

Moisture inside the oven can cause damage.

Do not use too much water on the cloth or sponge and do not let water or any other liquid find its way into any oven compartment openings.

Removing normal soiling

- Remove normal soiling immediately with warm water, washing-up liquid and a clean sponge or a clean, damp microfibre cloth.
- Remove all cleaning agent residues thoroughly with clean water. This is particularly important for any parts with a PerfectClean finish, as cleaning agent residues will impair the non-stick function.
- After cleaning, wipe the surfaces dry using a soft cloth.

Cleaning the food probe

Do not put the food probe into water or clean it in the dishwasher as this will damage it.

Clean the food probe with a damp cloth only.

Removing stubborn soiling

Spilt fruit and roasting juices may cause lasting discolouration or matte patches on enamelled surfaces. This discolouration is permanent but will not affect the efficiency of the finish. Do not attempt to remove these marks. Clean these following the instructions given here.

- Moisten stubborn soiling with a solution of hot water and washing-up liquid and leave to soak for a few minutes.
- You can then also use the scouring pad on the back of a washing-up sponge to remove the soiling.

Using oven cleaners

- Very stubborn soiling on PerfectClean surfaces can be cleaned using the Miele oven cleaner, which must only be applied to cold surfaces.

If the oven spray gets into gaps and openings, a strong odour is generated during subsequent cooking programmes.

Do not spray the oven cleaner onto the roof of the oven compartment. Do not spray the oven cleaner into the gaps and openings of the oven compartment walls and rear wall.

- Follow the instructions on the packaging.

Cleaning and care

Oven cleaners from other manufacturers must only be used in a cold oven and for no longer than a maximum of 10 minutes.

- You can then also use the scouring pad on the back of a washing-up sponge to remove the soiling.
- Remove all cleaning agent residues thoroughly with clean water.
- Dry all surfaces with a soft cloth.

Lowering the top heat/grill element

If the oven compartment roof is badly soiled, the top heat/grill element can be lowered to make cleaning easier. Clean the oven compartment roof regularly with a damp cloth or a dishwashing sponge.

 Risk of injury caused by hot surfaces.

The oven gets hot during operation. You could burn yourself on the heating elements, oven compartment or accessories.

Allow the heating element, oven compartment and the accessories to cool before manual cleaning.

The oven compartment floor can be scratched by the falling nut. Place a cloth over the oven compartment floor to protect it.

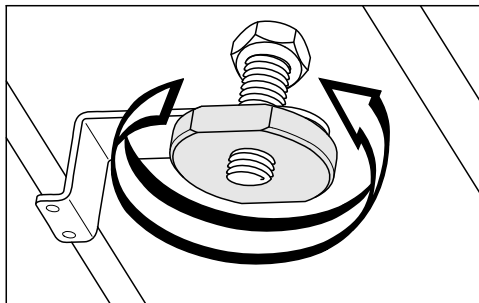

- Undo the nut.

Use caution not to damage the top heat/grill element.

Do not use force when lowering the top heat/grill element.

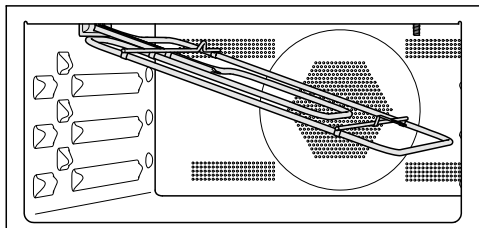

- Carefully lower the top heat/grill element.

The liner on the oven compartment roof can be damaged.

Do not use the abrasive side of the dishwashing sponge to clean the roof liner.

The LED on the oven compartment roof can be damaged.

Do not clean the LED if possible.

- Clean the oven compartment roof with a damp cloth or a dishwashing sponge.
- After cleaning, raise the top heat/grill element gently back up again.
- Replace the nut and tighten it securely.

Problem solving guide





Many malfunctions and faults that can occur in daily operation can be easily remedied. You can save time and money in many cases, as you do not need to call the Miele Customer Service Department.

Information to help you rectify faults yourself can be found at www.miele.com/service.



The following tables are designed to help you to find the cause of a malfunction or a fault and to resolve it.

Problem	Cause and remedy
The display is dark.	You have selected the Time Display Off setting. When the oven is switched off, the display is dark. <ul style="list-style-type: none"> ■ As soon as the oven is switched on, the main menu will appear. If you want the time of day to be displayed constantly, select the Time Display On setting.
	There is no power to the oven. <ul style="list-style-type: none"> ■ Check that the oven plug is correctly inserted into the socket and switched on. ■ Check whether the circuit breaker has tripped. Contact a qualified electrician or the Miele Customer Service Department.
The buzzer does not sound.	The buzzers are deactivated or set at too low a volume. <ul style="list-style-type: none"> ■ Switch on the buzzers or increase the volume with Settings Volume Buzzer tones.
The oven compartment does not heat up.	Demo mode is active. You can select menu options in the display and the sensor controls, but the oven heating does not work. <ul style="list-style-type: none"> ■ Deactivate demo mode by selecting Settings Showroom programme Demo mode Off.
You cannot start a cooking programme.	The door is still open for a programme using microwave power. <ul style="list-style-type: none"> ■ Check if the door is closed properly.
	A power level or a cooking duration is not set for a programme using microwave power. <ul style="list-style-type: none"> ■ Make sure you have entered a microwave power level and a cooking duration.
	If you are cooking with a function which uses microwave power, not all of the required settings have been entered. <ul style="list-style-type: none"> ■ Make sure you have entered a microwave power level, a cooking duration and a temperature.



Problem solving guide

Problem	Cause and remedy
<p>The sensor controls or the movement sensor do not respond.</p>	<p>You have selected the Display QuickTouch Off setting. When the oven is switched off, the sensor controls and the movement sensor do not respond.</p> <ul style="list-style-type: none"> ■ As soon as the oven is switched on, the sensor controls and the movement sensor will respond. If you want the sensor controls and the movement sensor to respond even when the oven is switched off, select the Display QuickTouch On setting. <p>The settings for the movement sensor are switched off.</p> <ul style="list-style-type: none"> ■ Change the settings for the movement sensor by selecting Settings Movement sensor. <p>The movement sensor is defective.</p> <ul style="list-style-type: none"> ■ Call the Miele Customer Service Department. <p>The oven is not connected to the power supply.</p> <ul style="list-style-type: none"> ■ Check that the oven plug is correctly inserted into the socket and switched on. ■ Check whether the fuse has tripped. Contact a qualified electrician or the Miele Customer Service Department. <p>If the display does not respond, there is a fault with the controls.</p> <ul style="list-style-type: none"> ■ Touch and hold the ⏻ On/Off sensor control until the display switches off and the oven restarts.
<p>System lock  appears in the display when the oven is switched on.</p>	<p>The  system lock has been activated.</p> <ul style="list-style-type: none"> ■ You can deactivate the system lock for a cooking programme by touching the  symbol for at least 6 seconds. ■ If you want to permanently deactivate the system lock, select the Safety System lock  Off setting.
<p>Power cut -process cancelled appears in the display.</p>	<p>There has been a brief power cut. This has caused the current cooking programme to stop.</p> <ul style="list-style-type: none"> ■ Switch the oven off and then back on again. ■ Restart the cooking programme.
<p>12:00 appears in the display.</p>	<p>The power supply was interrupted for longer than 150 hours.</p> <ul style="list-style-type: none"> ■ Reset the time and date.
<p>Maximum operating hours reached appears in the display.</p>	<p>The oven has been operating for an unusually long time. This has triggered the safety switch-off function.</p> <ul style="list-style-type: none"> ■ Confirm with OK. <p>The oven is now ready to use.</p>

Problem solving guide

Problem	Cause and remedy
Fault and a fault code not listed here appears in the display.	A fault has occurred that you cannot resolve. ■ Call the Miele Customer Service Department.
If the door is opened while cooking with the Micro-wave  function, the oven stops making noise.	This is not a fault. If the door is opened while cooking with the Microwave  function, the door contact switch will switch off the microwave oven and switch the cooling fan to a lower speed.
A noise can be heard after a cooking programme.	The cooling fan remains switched on after a cooking programme (see “Settings – Cooling fan run-on”).
An abnormal sound can be heard when the microwave oven is operating.	A metal dish has been used during a cooking programme using microwave power. ■ Check if there are sparks caused by using metal dishes (see the requirements specified for crockery in the section on microwave operation).
	The food was covered with aluminium foil during a programme with microwave power. ■ If necessary, remove the foil cover.
	The rack was used during a programme with microwave power. ■ Always use the glass tray for programmes with microwave power.
The oven has switched itself off.	To save power, the oven switches off automatically if a button is not pressed after a certain amount of time or after a cooking programme has ended. ■ Switch the oven back on.
Cakes/biscuits are not cooked properly after the duration given in the cooking chart.	A different temperature from the one given in the recipe was used. ■ Select the temperature required for the recipe.
	The ingredient quantities are different from those given in the recipe. ■ Check whether you amended the recipe. The addition of more liquid or more eggs makes a moister mix which requires a longer cooking duration.

Problem solving guide

Problem	Cause and remedy
<p>The browning is uneven.</p>	<p>The wrong temperature or shelf level was selected.</p> <ul style="list-style-type: none"> ■ There will always be a slight unevenness in browning. If browning is very uneven, check whether the correct temperature and shelf level were selected.
	<p>The material or colour of the baking tin is not suitable for the function selected. Light-coloured, shiny or thin-walled tins are less suitable. These reflect the oven's heat, which means that the heat does not penetrate to the food effectively, resulting in uneven or poor browning.</p> <ul style="list-style-type: none"> ■ Dark matt tins are best for baking.
<p>The food is not sufficiently heated or is not cooked at the end of a set duration when using the <small>Micro-wave</small>  function.</p>	<p>Check whether the programme using microwave power has been interrupted and has not restarted.</p> <ul style="list-style-type: none"> ■ Restart the cooking programme to ensure the food is heated or cooked properly.
	<p>When cooking or reheating with microwave power, the time set was too short.</p> <ul style="list-style-type: none"> ■ Check that the correct duration is selected for the microwave power level. The lower the microwave power level the longer the cooking duration.
<p>Food has cooled down too quickly after being re-heated or cooked using microwave power.</p>	<p>In the microwave oven, food begins to cook from the outside first, the inside of the food relying on the slower conduction of heat. If food is cooked at a high microwave power level, it is possible that the heat may not have reached the centre of the food, so it is hot on the outside but cold in the centre. During the standing time, the heat is transferred to the centre of the food.</p> <ul style="list-style-type: none"> ■ When heating food with different densities, such as with menu cooking, it is sensible to start with a low microwave power level and select a longer reheating duration.
<p>The oven interior lighting switches off after a short time.</p>	<p>You have selected the Lighting "On" for 15 seconds setting.</p> <ul style="list-style-type: none"> ■ If you want the oven interior lighting to be switched on during the entire cooking programme, select the Lighting On setting.
<p>The oven interior lighting is off or does not switch on.</p>	<p>You have selected the Lighting Off setting.</p> <ul style="list-style-type: none"> ■ Press the  sensor control to switch on the oven interior lighting for 15 seconds. ■ If required, select the Lighting On or "On" for 15 seconds setting.
	<p>The oven interior lighting is faulty.</p> <ul style="list-style-type: none"> ■ Call the Miele Customer Service Department.

Information to help you rectify faults yourself and about Miele spare parts can be found at www.miele.com/service.

Contact in the event of a fault

In the event of any faults which you cannot remedy yourself, please contact your Miele dealer or the Miele Customer Service Department.

You can book a Miele Customer Service Department call-out online at www.miele.com/service.

Contact information for the Miele Customer Service Department can be found at the end of this document.

Please quote the model identifier and serial number of your appliance (Fabr./SN/Nr.) when contacting the Miele Customer Service Department. This information can be found on the data plate.

Please note that telephone calls may be monitored and recorded for training purposes and that a call-out charge will be applied to service visits where the problem could have been resolved as described in this booklet.

This information is given on the data plate, which is visible on the front frame of the oven when the door is fully open.

Warranty

The appliance warranty is valid for 2 years from date of purchase.

For further information, please refer to the warranty conditions in the booklet provided.

Installation

Installation dimensions

Dimensions are given in mm.

Installation in a tall or base unit

When building the oven into a base unit underneath a hob, please also observe the installation instructions for the hob as well as the building-in depth required for the hob.

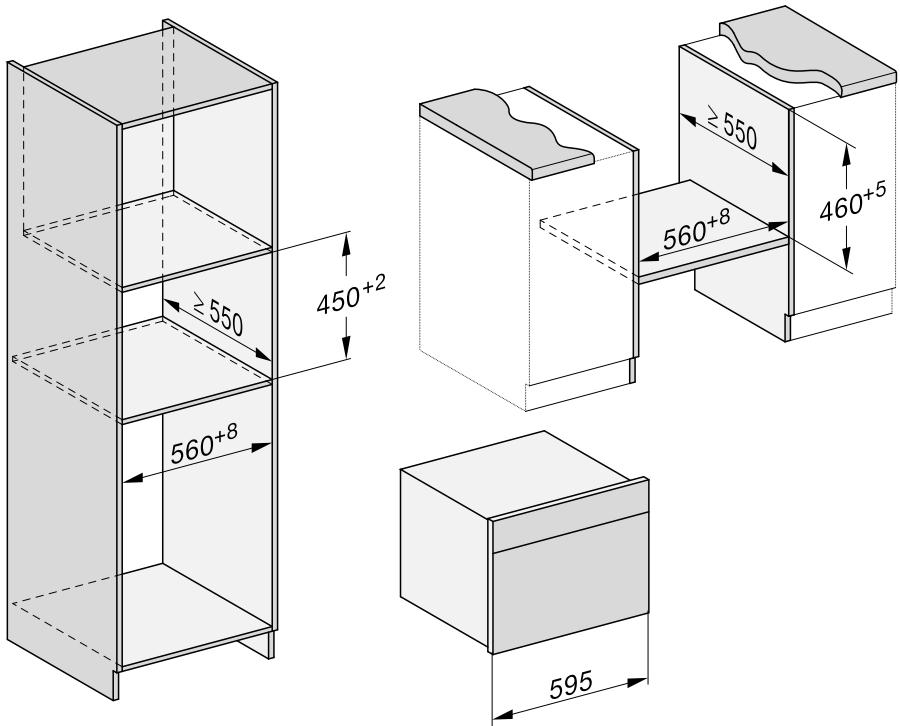

Side view

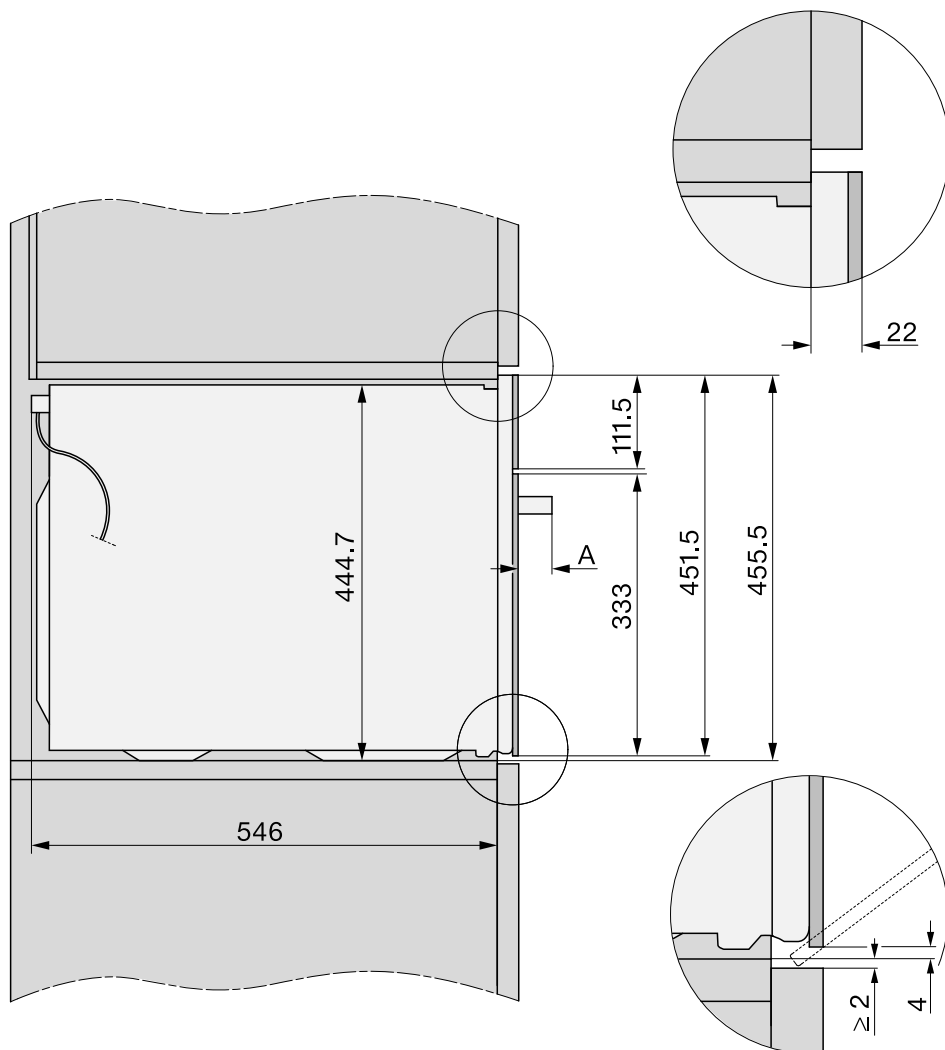

A 47 mm

Installation

Connections and ventilation

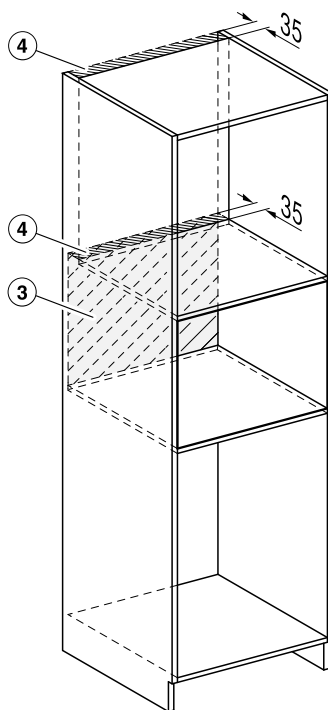
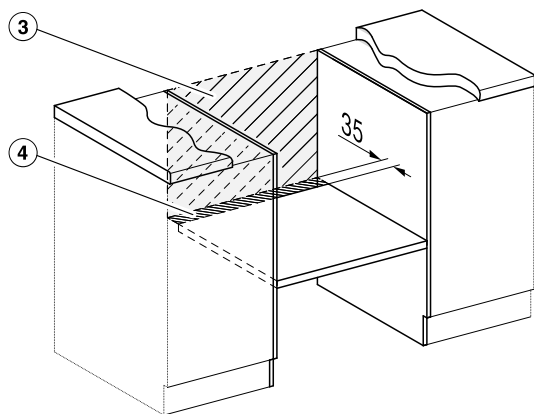
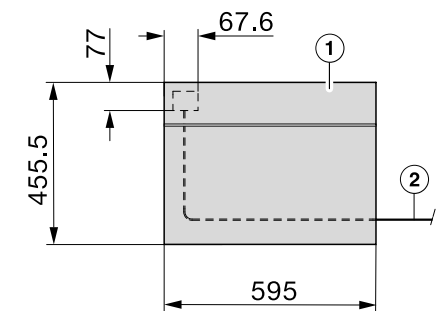

- ① Front view
- ② Mains connection cable, length = 2000 mm
- ③ No connections permitted in this area
- ④ Ventilation cut-out, min. 150 cm²

Installing the oven

- Connect the oven to the electrical supply.
- Push the oven into the housing unit and align it.

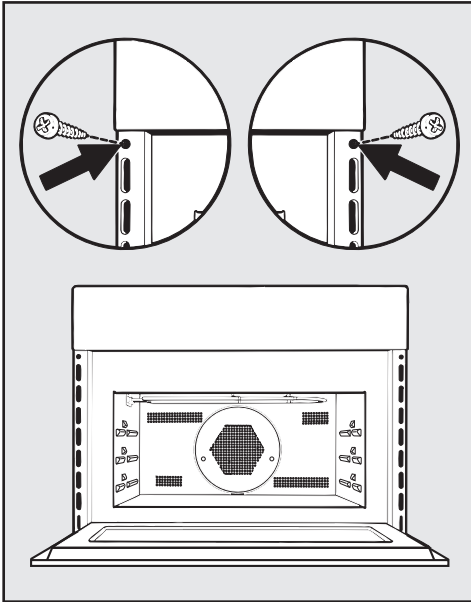

- Open the door and use the screws supplied to secure the oven to the side walls of the housing unit.

Installation

Electrical connection

The oven is equipped with a mains connection cable and plug for connection to a 50 Hz, 230 V alternating current supply.

The fuse rating must be at least 16 A.

The appliance must only be connected to a correctly installed earthed socket. The electrical installation must comply with VDE 0100 requirements.

Ensure that the plug and switch are accessible at all times.

If the appliance is hardwired or if the switch is not accessible after installation, an additional means of disconnection means must be provided.

Suitable means of disconnection include accessible switches with an all-pole contact gap of at least 3 mm. These include circuit breakers, fuses and contactors (EN 60335).

Connection data is given on the data plate situated at the front of the oven compartment. Please ensure the connection data matches the household supply.

When contacting Miele, please quote the following:

- Model identifier
- Serial number
- Connection data (mains voltage/frequency/maximum rated load)

If the mains connection cable is damaged, a new one must be fitted by a service technician authorised by the Miele Customer Service Department.

This compact microwave combination oven complies with European standard EN 55011. It is classified as a Group 2, class B appliance.

Group 2 appliances use high frequency energy in the form of electromagnetic waves to create heat in food.

Class B is assigned to appliances that are suitable for domestic use.

Temporary or permanent operation on an autonomous power supply system or a power supply system that is not synchronised with the mains power supply (e.g. island networks, back-up systems) is possible. A prerequisite for operation is that the power supply system complies with the specifications of EN 50160 or an equivalent standard. The function and operation of the protective measures provided in the domestic electrical installation and in this Miele product must also be maintained in isolated operation or in operation that is not synchronised with the mains power supply, or these measures must be replaced by equivalent measures in the installation. As described, for example, in the current version of VDE-AR-E 2510-2.

Batter

Cakes/biscuits (accessories)		+ [°C] + [W]		₁	 [min]	CF
Muffins		150–160	✓	2	35–45	–
		160–170	✓	2	35–45	–
Small cakes (1 glass tray)*		150	–	2	25–35	–
		170 ²	–	2	20–30	–
Small cakes (2 glass trays)*		140	–	2+3	35–45	–
Madeira cake (loaf tin, 30 cm)	₁	160–170 + 80	✓	1	35–45	–
		150–160	–	1	60–70	–
Ring cake (ring tin/Bundt cake tin, Ø 26 cm)	₁	160–170 + 150	✓	1	40–50	–
Marble, nut cake (loaf tin, 30 cm)		150–160	✓	1	65–75	–
		150–160	✓	1	65–75	–
Marble, nut cake (ring tin/Bundt cake tin, Ø 26 cm)		150–160	✓	1	55–65	–
		150–160	✓	1	65–75	–
Fresh fruit cake (1 glass tray)		150–160	✓	2	50–60	–
		160–170	–	2	55–65	–
Fresh fruit cake (springform cake tin, Ø 26 cm)		150–160	✓	1	55–65	–
		165–175 ²	–	1	50–60	–
Flan base (flan base tin, Ø 28 cm)		150–160	✓	1	25–35	–
		170–180 ²	✓	1	15–25	–

Operating mode, Temperature, Microwave power level, Booster, ₁ Shelf level, Cooking duration, CF Crisp function, Fan plus, Conventional heat, MW + Fan plus, ✓ On, – Off























* The settings also apply for testing in accordance with EN 60350-1.









¹ Place the baking tin in the centre of the glass tray.

² Pre-heat the oven before putting food inside.

Cooking charts

Shortcrust pastry

Cakes/biscuits (accessories)		 [°C]		 ³ ₁	 [min]	CF
Biscuits (1 glass tray)		140–150	✓	2	20–30	–
		160–170	✓	2	10–20	–
Drop cookies (1 glass tray)*		140	–	2	40–50	–
		160 ¹	–	2	30–40	–
Drop cookies (2 glass trays)*		140	–	2+3	45–55 ²	–
Flan base (flan base tin, Ø 28 cm)		150–160	✓	2	30–40	–
		170–180 ¹	✓	1	20–30	–
Cheesecake (springform cake tin, Ø 26 cm)		160–170	–	1	90–100	–
		150–160	–	1	80–90	–
Apple pie, single crust (springform cake tin, Ø 20 cm)*		160	–	1	110–120	–
		180	–	1	80–90	–
Apple pie, double crust (springform cake tin, Ø 26 cm)		160–170	✓	1	55–65	–
		150–160	✓	1	60–70	–
Fresh fruit cake, glazed (springform cake tin, Ø 26 cm)		160–170	✓	1	55–65	–
		150–160	✓	1	60–70	–
Fresh fruit cake, with meringue topping (1 glass tray)		160–170	✓	2	50–60	–
Sweet flan (1 glass tray)		230–240 ¹	–	1	40–50	✓



















 Operating mode,  Temperature,  Booster, ³₁ Shelf level,  Cooking duration, CF Crisp function,  Fan plus,  Conventional heat,  Intensive bake, ✓ On, – Off









* The settings also apply for testing in accordance with EN 60350-1.

¹ Pre-heat the oven before putting food inside.

² Take the trays out of the oven early if the food is sufficiently browned before the specified cooking duration has elapsed.









Yeast dough







Cakes/biscuits (accessories)		 +  [°C] + [W]		 ³ ₁	 [min]	CF
Bundt cake (Bundt cake tin, Ø 24 cm)		140–150	✓	1	55–65	–
		150–160	✓	1	60–70	–
Stollen (1 glass tray)		150–160	✓	1	60–70	–
		160–170	✓	1	55–65	–
Streusel cake with/without fruit (1 glass tray)		160–170	✓	2	40–50	–
		170–180 + 150	–	2	30–40	–
Fresh fruit cake (1 glass tray)		160–170	✓	2	40–50	–
		170–180 + 150	–	2	25–35	–
Apple turnovers/raisin whirls (1 glass tray)		160–170 ¹	✓	2	20–30	–
White bread (free-form) (1 glass tray)		180–190	–	2	35–45	–
White bread (loaf tin, 30 cm)		190–200	✓	1	50–60	–
Wholegrain bread (loaf tin, 30 cm)		180–190	✓	1	40–50	–
Proving yeast dough (bowl)		30	–	1	30	–

 Operating mode,  Temperature,  Booster, ³₁ Shelf level,  Cooking duration, CF Crisp function,  Fan plus,  Conventional heat,  MW + Fan plus, ✓ On, – Off

¹ Pre-heat the oven before putting food inside.











Quark dough









Cakes/biscuits (accessories)		 +  [°C] + [W]		 ³ ₁	 [min]	CF
Fresh fruit cake (1 glass tray)		160–170	✓	2	40–50	–
		170–180 + 150	–	2	25–35	–
Apple turnovers/raisin whirls (1 glass tray)		160–170	✓	2	20–30	–

 Operating mode,  Temperature,  Booster, ³₁ Shelf level,  Cooking duration, CF Crisp function,  Fan plus,  MW + Fan plus, ✓ On, – Off

Cooking charts

Sponge mixture

Cakes/biscuits (accessories)		 [°C]		 3 1	 [min]	CF
Sponge cake base (2 eggs, springform cake tin, Ø 26 cm)		170–180 ²	–	1	15–25	–
Sponge cake base (4 eggs, springform cake tin, Ø 26 cm)		170–180 ²	–	1	25–35	–
Whisked sponge (springform cake tin, Ø 26 cm)*		180–190 ²	–	2	20–30	–
		150–180 ²	–	1	20–45	–
Swiss roll sponge (1 glass tray)		170–180 ²	–	2	15–25	–













 Operating mode,  Temperature,  Booster,  Shelf level,  Cooking duration, CF Crisp function,  Conventional heat,  Fan plus,  On, – Off









* The settings also apply for testing in accordance with EN 60350-1.

¹ In general, if a range of temperatures is given, it is best to select the lower temperature and to check the food after the shortest cooking duration.

² Pre-heat the oven before putting food inside.

















Choux pastry, puff pastry, meringue











Cakes/biscuits (accessories)		 [°C]		 3 1	 [min]	CF
Choux buns (1 glass tray)		160–170		2	30–40	–
Pastry puffs (1 glass tray)		170–180 ¹		2	15–25	–
Macaroons (1 glass tray)		120–130 ¹		2	28–38	–
Meringues/pavlovas (1 glass tray, 1 tray of 6 Ø 6 cm)		80–100	–	2	120–150	–

 Operating mode,  Temperature,  Booster,  Shelf level,  Cooking duration, CF Crisp function,  Fan plus,  Conventional heat,  On, – Off

¹ Pre-heat the oven before putting food inside.

Savoury dishes

Food (accessories)		 +  [°C] + [W]		 ³ ₁	 [min]	CF
Savoury flan (1 glass tray)		240–250 ²	✓	1	35–45	✓
Onion tart (1 glass tray)		180– 190 + 150	–	2	30–40	–
		150–160	✓	1	30–40	–
Pizza, yeast dough (1 glass tray)		160–170 + 80	–	2	25–35	–
		180–190 ²	✓	2	30–40	✓
Pizza, quark dough (1 glass tray)		150–160	–	2	25–35	–
		190–200 ²	✓	2	30–40	✓
Toast* (wire rack)	 ¹	3 ³	–	2	2–4	–
Baked dishes/gratins (e.g. toast) (wire rack on the glass tray)	 ¹	3	–	2	5–9	–
Grilled vegetables (wire rack on the glass tray)	 ¹	3 ³	–	2	10–12 ⁴	–
		210–220 ³	–	2	8–10 ⁴	–

 Operating mode,  Temperature,  Booster, ³₁ Shelf level,  Cooking duration, CF Crisp function,  Conventional heat,  MW + Fan plus,  Intensive bake,  Fan plus,  Grill,  Fan grill, ✓ On, – Off

* The settings also apply for testing in accordance with EN 60350-1.

¹ Select the specified grill level.

















² Pre-heat the oven before putting food inside.











³ Pre-heat the oven for 5 minutes before putting food inside.

⁴ Turn the food halfway through cooking.

Cooking charts

Beef

Food (accessories)		 [°C]		 3	 [min]	 [°C]
Braised beef, approx. 1 kg (roasting dish with lid)	 ²	150–160	✓	1	120–130 ⁶	–
Fillet of beef, approx. 1 kg ¹	 ²	180–190 ⁴	–	1	30–70	45–75
Fillet of beef (rare), approx. 1 kg ¹	 ²	95–100	–	1	65–75	45–48
Fillet of beef (medium), approx. 1 kg ¹	 ²	95–100	–	1	70–80	54–57
Fillet of beef (well done), approx. 1 kg ¹	 ²	95–100	–	1	110–120	63–66
Sirloin joint, approx. 1 kg ¹	 ²	180–200 ⁴	✓	1	35–75	45–75
Sirloin joint (rare), approx. 1 kg ¹	 ²	95–100	–	1	40–50	45–48
Sirloin joint (medium), approx. 1 kg ¹	 ²	95–100	–	1	75–85	54–57
Sirloin joint (well done), approx. 1 kg ¹	 ²	95–100	–	1	110–120	63–66
Burgers ^{*1}	 ³	3 ⁵	–	2	1: 17–22 2: 5–10 ⁷	–
Meat patties ¹	 ³	3 ⁵	–	2	1: 10–15 2: 5–10 ⁷	–

 Operating mode,  Temperature,  Booster,  Shelf level,  Cooking duration,  Core temperature,  Fan plus,  Conventional heat,  Special application Low temp. cooking,  Grill, ✓ On, – Off

* The settings also apply for testing in accordance with EN 60350-1.

¹ Use the wire rack and glass tray.

² Sear the meat on the hob first.

³ Select the specified grill level.

















⁴ Pre-heat the oven before putting food inside.











⁵ Pre-heat the oven for 5 minutes before putting food inside.

⁶ Roast with the lid on to start with. Remove the lid 60 minutes into the cooking duration and add approx. 0.5 litres of liquid.

⁷ Turn the food once it has browned sufficiently (1: grill duration side 1, 2: grill duration side 2).

Veal

Food (accessories)		 +  [°C] + [W]		 ³ 1	 [min]	 [°C]
Braised veal, approx. 1.5 kg (roasting dish with lid)	 ²	160–170	✓	1	120–130 ⁴	–
	 ²	160–170 + 150	✓	1	80–90 ⁴	–
Fillet of veal, approx. 1 kg (glass tray)	 ²	180–190 ³	–	1	20–50	45–75
Fillet of veal (pink), approx. 1 kg ¹	 ²	95–100	–	1	50–60	45–48
Fillet of veal (medium), approx. 1 kg ¹	 ²	95–100	–	1	80–90	54–57
Fillet of veal (well done), approx. 1 kg ¹	 ²	95–100	–	1	85–95	63–66
Saddle of veal (pink), approx. 1 kg ¹	 ²	95–100	–	1	80–90	45–48
Saddle of veal (medium), approx. 1 kg ¹	 ²	95–100	–	1	120–130	54–57
Saddle of veal (well done), approx. 1 kg ¹	 ²	95–100	–	1	140–150	63–66

 Operating mode,  Temperature,  Booster, ³ Shelf level,  Cooking duration,  Core temperature,  Fan plus,  Conventional heat,  MW + Fan plus,  Special application Low temp. cooking, ✓ On, – Off

¹ Use the wire rack and glass tray.

² Sear the meat on the hob first.

³ Pre-heat the oven before putting food inside.

⁴ Roast with the lid on to start with. Remove the lid 60 minutes into the cooking duration and add approx. 0.5 litres of liquid.

Cooking charts















Pork











Food (accessories)		+ [°C] + [W]		³	 [min]	 [°C]
Pork joint/pork neck roast, approx. 1 kg (roasting dish with lid)	¹	160–170 + 150	✓	1	80–90 ⁵	80–90
		170–180	✓	1	100–110 ⁵	80–90
Pork joint with crackling, approx. 2 kg (roasting dish)	¹	170–180 + 150	✓	1	70–80 ⁶	80–90
		170–180	✓	1	100–110 ⁶	80–90
Pork tenderloin, approx. 350 g (wire rack on the glass tray)	²	95–100	–	1	60–120	60–75
Gammon joint, approx. 1 kg (glass tray)		170–180 + 150	–	1	40–50	63–68
Meat loaf, approx. 1 kg (glass tray)		170–180 + 150	–	1	35–45 ⁶	80–85
		180–190	✓	1	60–70 ⁶	80–85
Bacon (wire rack on the glass tray)	³	3 ⁴	–	2	5–10	–
Sausages (wire rack on the glass tray)	³	3 ⁴	–	2	15–20 ⁷	–

Operating mode, Temperature, Booster, ³ Shelf level, Cooking duration, Core temperature, MW + Auto roast, Conventional heat, Special application Low temp. cooking, MW + Fan plus, Grill, ✓ On, – Off

- ¹ Use crockery that is microwave safe.
- ² Sear the meat on the hob first.
- ³ Select the specified grill level.
- ⁴ Pre-heat the oven for 5 minutes before putting food inside.
- ⁵ Roast with the lid on to start with. Remove the lid 60 minutes into the cooking duration and add approx. 0.5 litres of liquid.
- ⁶ Add approx. 0.5 litres of liquid halfway through the cooking duration.
- ⁷ Turn the food halfway through cooking.

Lamb, game

Food (accessories)		 +  [°C] + [W]		 ³ ₁	 [min]	 [°C]
Leg of lamb on the bone, approx. 1.5 kg (roasting dish with lid)		170–180 + 80	✓	1	100–120 ³	64–82
		180–190	✓	1	110–120 ³	64–82
Saddle of lamb, off the bone (wire rack on the glass tray)	 ¹	180–190 ²	–	1	15–40	53–80
	 ¹	95–100	–	1	35–90	53–68
Saddle of venison, off the bone (roasting dish)	 ¹	180–190 ²	–	1	45–75	60–81
Saddle of roebuck, off the bone (glass tray)	 ¹	140–150 ²	–	1	20–40	60–81
Leg of wild boar, off the bone, approx. 1 kg (roasting dish with lid)	 ¹	180–190	✓	1	90–120 ³	80–90

 Operating mode,  Temperature,  Booster, ³₁ Shelf level,  Cooking duration,  Core temperature,  MW + Auto roast,  Conventional heat,  Special application Low temp. cooking,  Auto roast, ✓ On, – Off

- ¹ Sear the meat on the hob first.
- ² Pre-heat the oven before putting food inside.
- ³ Roast with the lid on to start with. Remove the lid 60 minutes into the cooking duration and add approx. 0.5 litres of liquid.

Cooking charts

Poultry, fish

















Food (accessories)		+ [°C] + [W]		³ ₁	 [min]	 [°C]
Poultry, 0.8–1.5 kg (wire rack on the glass tray)		160–170	✓ ²	1	55–65	85–90
		170–180 + 150	–	1	40–50	85–90
Chicken, approx. 1.2 kg (wire rack on the glass tray)		180–190 ¹	– ²	1	60–70 ³	85–90
	*	200 + 150	–	1	45–55 ³	85–90
Poultry, approx. 2 kg (shallow ovenproof dish on the glass tray)		160–170	✓ ²	1	110–140	85–90
		170–180 + 80	–	1	100–120	85–90
Poultry, approx. 4 kg (roasting dish on the glass tray)		160–170 + 80	–	1	150–160 ⁴	90–95
		180–190	✓ ²	1	180–200 ⁴	90–95
Fish, 200–300 g (e.g. trout) (glass tray)		160–170 + 150	–	1	15–25	75–80
Fish, 1–1.5 kg (e.g. salmon trout) (glass tray)		160–170 + 150	–	1	20–30	75–80









Operating mode, Temperature, Booster, ³₁ Shelf level, Cooking duration, Core temperature, Auto roast, MW + Auto roast, Fan grill, MW + Fan grill, MW + Fan plus, Conventional heat, ✓ On, – Off

* The settings also apply for testing in accordance with EN 60705.

- ¹ Pre-heat the oven for 5 minutes before putting food inside.
- ² Switch on the Crisp function.
- ³ Turn the food half way through grilling.
- ⁴ Add approx. 0.5 litres of liquid after 30 minutes.

Test food according to EN 60350-1













Test food (accessories)		 [°C]		 3 1	 [min]	CF
Small cakes (1 glass tray ¹)		150	–	2	25–35	–
		170 ⁵	–	2	20–30	–
Small cakes (2 glass trays ¹)		140	–	2+3	35–45	–
Drop cookies (1 glass tray ¹)		140	–	2	40–50	–
		160 ⁵	–	2	30–40	–
Drop cookies (2 glass trays ¹)		140	–	2+3	45–55 ⁷	–
Apple pie (wire rack ¹ , springform cake tin ² , Ø 20 cm)		160	–	1	110–120	–
		180	–	1	80–90	–
Whisked sponge (wire rack ¹ , springform cake tin ² , Ø 26 cm)		180–190 ⁵	–	2	20–30	–
	 3	150–180 ⁵	–	1	20–45	–
Toast (wire rack ¹)	 4	3 ⁶	–	2	2–4	–
Burgers (wire rack ¹ on the glass tray ¹)	 4	3 ⁶	–	2	1: 17–22 2: 5–10 ⁸	–









 Operating mode,  Temperature,  Booster,  Shelf level,  Cooking duration, CF Crisp function,  Fan plus,  Conventional heat,  Grill, ✓ On, – Off

- ¹ Only use original Miele accessories.
- ² Use a dark matt springform cake tin.
Place the springform cake tin centrally on the wire rack.
- ³ In general, if a range of temperatures is given, it is best to select the lower temperature and to check the food after the shortest cooking duration.
- ⁴ Select the specified grill level.
- ⁵ Pre-heat the oven before putting food inside.
- ⁶ Pre-heat the oven for 5 minutes before putting food inside.
- ⁷ Take the trays out of the oven early if the food is sufficiently browned before the specified cooking duration has elapsed.
- ⁸ Turn the food once it has browned sufficiently (1: grill duration side 1, 2: grill duration side 2).

Notes for test institutes

Test food in accordance with EN 60705 (microwave operating mode)

Test food		 [W]	 [min]	 ² [min]	Notes ³
Custard, 1000 g		600 + 450	6 + 15–18	120	Crockery see Standard, dimensions at the upper rim 250 mm x 250 mm, cook uncovered
Madeira cake, 475 g		450	8–11	5	Crockery see Standard, external diameter at the upper rim 220 mm, cook uncovered
Minced meat, 900 g		600 + 450	8 + 12	5	Crockery see Standard, dimensions at the upper rim 250 mm x 124 mm, cook uncovered
Potato gratin, 1100 g		300 + 170 °C	25–35	5	Crockery see Standard, external diameter at the upper rim 220 mm, cook uncovered
Chicken, 1200 g		150 + 200 °C	45–55 ¹	2	Place the chicken on the wire rack with the breast facing down to start with and slide the wire rack into the oven compartment on top of the glass tray.
Defrost meat, (minced meat), 500 g		Meat \ 500 g	16–18 ¹	10	Crockery see Standard, defrost uncovered
		150	16–19 ¹	10	Crockery see Standard, defrost uncovered
Raspberries, 250 g		Fruit \ 250 g	Approx. 8	3	Crockery see Standard, defrost uncovered
		150	6–8	3	Crockery see Standard, defrost uncovered

 Operating mode,  Microwave power level,  Defrost or cooking duration,  Standing time,  Microwave,  MW + Fan plus,  MW + Fan grill,  Special application Defrost

- Turn the food halfway through cooking/defrosting.
- Allow the food to stand at room temperature for the standing time quoted to enable the heat to spread evenly throughout the food.
- Slide the glass tray into the oven on shelf 1 and place the crockery in the centre of it.

Power rating in off mode, time of day display off	max. 0.3 W
Power rating in off mode, time of day display on	max. 0.8 W
Power rating in networked standby	max. 2.0 W
Time until automatic switch to off mode	20 min
Time until automatic switch to networked standby	20 min
Frequency range of the WiFi module	2.4000–2.4835 GHz
Transmission power of the WiFi module	max. 100 mW

Declaration of conformity

Miele hereby declares that this oven complies with Directive 2014/53/EU.

The complete text of the EU declaration of conformity is available from one of the following internet addresses:

- Products, Download from www.miele.co.uk
- For service, information, operating instructions etc: go to <https://miele.de/gebrauchsanweisungen> and enter the name of the product or the serial number

UK Conformity declaration

Miele hereby declares that this oven complies with UK Radio Equipment Regulations 2017, as amended.

The complete text of the UK declaration of conformity is available from one of the following internet addresses:

- Products, Download from www.miele.co.uk
- For service, information, operating instructions etc: go to <https://miele.co.uk/manuals> and enter the name of the product or the serial number

Technical data

This **Statement of Compliance** confirms this Miele product fully complies with the **Product Security and Telecommunications Infrastructure (Security Requirements for Relevant Connectable Products) Regulations 2023**.

- 1) Household Appliance – *Oven for building-in; BM60R1-00W, BM60R2-00W, BM60PM-00W, BM60PT-00W, DO60PT-00W*
- 2) Manufactured by: Miele & Cie KG,
Carl Miele Street 29, 33332 Gutersloh Germany
Imported by and contact point: Miele Company Ltd, Fairacres, Marcham Road, Abingdon, Oxon, OX14 ITW Great Britain
- 3) The defined support period at the time of first supply is 10 years
- 4) To report vulnerabilities and cybersecurity issues please contact: psirt@miele.com
- 5) Signature 
Name: **Paul Wright**
Company Position: **Head of Technical Management**
Date of signature: **19th March 2024**
Place of signature: **Abingdon, Oxfordshire**

Copyrights and licences for the communication module

For the purpose of operating and controlling the communication module, Miele uses proprietary or third-party software that is not covered by open source licensing terms. These items of software/software components are protected by copyright. The copyrights held by Miele and third parties must be respected.

Furthermore, this communication module contains software components which are distributed under open source licence conditions. The open source components contained in the appliance along with the corresponding copyright notices, copies of the licensing terms valid at the time, and any further information can be accessed locally via IP using a web browser (*http://<IP address>/Licenses*). The liability and warranty arrangements for the open source licences displayed in this location only apply in relation to the respective rights holders.

Copyrights and Licences

Miele uses their own and third party software which is not subject to any so-called Open Source Licence for the operation and control of the appliance. This software/ these software components are protected by copyright. The copyright powers of Miele and third parties have to be respected.

Furthermore, this appliance contains software components which are distributed under Open Source licence conditions. Please refer to [Settings | Legal information | Open Source licences](#) in the appliance for the Open Source components contained therein, together with the corresponding copyright notices, copies of the licence terms valid at the time, and any further information. The liability and warranty provisions of the Open Source licence terms and conditions as stated therein apply only in relation to the respective rights holders.

In particular, the appliance contains software components licenced by the copyright holders under the GNU General Public License, Version 2, or the GNU Lesser General Public License, Version 2.1. For a period of at least 3 years from the date of purchase or delivery of the appliance respectively, Miele offers to provide you or third parties with a machine-readable copy of the source code of the Open Source components contained in the appliance and licenced under the terms of the GNU General Public License, Version 2, or the GNU Lesser General Public License, Version 2.1, on a data carrier (CD-ROM, DVD or USB stick). Please contact us via e-mail (info@miele.com) or the below postal address and state the product name, the serial number and the date of purchase to obtain this source code.

Miele & Cie. KG
Open Source
GTZ/TIM
Carl-Miele-Straße 29
33332 Gütersloh

Please note the limited warranty in favour of the rights holders under the terms of the GNU General Public License, Version 2, and the GNU Lesser General Public License, Version 2.1:

This program is distributed in the hope that it will be useful, but WITHOUT ANY WARRANTY, without even the implied warranty of MERCHANTABILITY of FITNESS FOR A PARTICULAR PURPOSE. See the GNU General Public License and GNU Lesser General Public License for more details.

United Kingdom

Miele Co. Ltd., Fairacres, Marcham Road, Abingdon, Oxon, OX14 1TW
Tel: 0330 160 6600, Internet: www.miele.co.uk, E-mail: info@miele.co.uk

Australia

Miele Australia Pty. Ltd.
ACN 005 635 398
ABN 96 005 635 398
Level 4, 141 Camberwell Road
Hawthorn East, VIC 3123
Tel: 1300 464 353
E-mail: info@miele.com.au
Internet: www.miele.com.au

China Mainland

Miele Electrical Appliances Co. Ltd.
No. 82, Shimenyi Road, JingAn District
Shanghai, China, P.R.C
Post Code: 200040
Phone: +86 21 6157 3500
Fax: +86 21 6157 3511
E-mail: info@miele.cn
Internet: www.miele.cn

Hong Kong, China

Miele (Hong Kong) Ltd.
41/F - 4101, Manhattan Place
23 Wang Tai Road
Kowloon Bay, Hong Kong
Tel: (852) 2610 1025
Fax: (852) 3579 1404
E-mail:
customerservices@miele.com.hk
Website: www.miele.hk

India

Miele India Pvt. Ltd.
1st Floor, Copia Corporate Suites,
Commercial Plot 9, Mathura Road,
Jasola, New Delhi - 110025
E-mail: customercare@miele.in
Website: www.miele.in

Ireland

Miele Ireland Ltd.
2024 Bianconi Avenue
Citywest Business Campus
Dublin 24
Tel: (01) 461 07 10
Tel: (01) 461 07 97
Fax: (01) 461 07 97
E-mail: info@miele.ie
Internet: www.miele.ie

Malaysia

Miele Sdn Bhd
Suite 12-2, Level 12
Menara Sapura Kencana
Petroleum
Solaris Dutamas No. 1
Jalan Dutamas 1
50480 Kuala Lumpur, Malaysia
Phone: +603-6209-0288
Fax: +603-6205-3768

New Zealand

Miele New Zealand Limited
IRD 98 463 631
8 College Hill
Freemans Bay, Auckland 1011
Tel: 0800 464 353
E-mail: customercare@miele.co.nz
Internet: www.miele.co.nz

Singapore

Miele Pte. Ltd.
29 Media Circle
#11-04 ALICE@Mediapolis
Singapore 138565
Tel: +65 6735 1191
Fax: +65 6735 1161
E-mail: info@miele.com.sg
Internet: www.miele.sg

South Africa

Miele (Pty) Ltd.
63 Peter Place, Bryanston 2194
P.O. Box 69434, Bryanston 2021
Tel: (011) 875 9000
Fax: (011) 875 9035
E-mail: info@miele.co.za
Internet: www.miele.co.za

Thailand

Miele Appliances Ltd.
BHIRAJ TOWER at EmQuartier
43rd Floor Unit 4301-4303
689 Sukhumvit Road
North Klongton Sub-District
Vadhana District
Bangkok 10110, Thailand

United Arab Emirates

Miele Appliances Ltd.
Showroom 1, Eiffel 1 Building
Sheikh Zayed Road, Umm Al Sheif
P.O. Box 114782 - Dubai
Tel. +971 4 3044 999
Fax. +971 4 3418 852
800-MIELE (64353)
E-mail: info@miele.ae
Website: www.miele.ae

Manufacturer: Miele & Cie. KG, Carl-Miele-Straße 29, 33332 Gütersloh, Germany

H 7640 BM

en-GB

M.-Nr. 11 196 362 / 00