

Miele



Operating and Installation Instructions Commercial Tumble Dryers PDR 514/518/522/528/544

To prevent accidents and machine damage, read these instructions **before** installation or use.

en-US, CA

M.-Nr. 11 790 582

⚠ WARNING: FIRE OR EXPLOSION HAZARD

Failure to follow safety warnings exactly could result in serious injury, death or property damage.

Do not store or use gasoline or other flammable vapors and liquids in the vicinity of this or any other appliance.

WHAT TO DO IF YOU SMELL GAS

Do not try to light any appliance.

Do not touch any electrical switch; do not use any phone in your building.

Clear the room, building or area of all occupants.

Immediately call your gas supplier from a neighbor's phone. Follow the gas supplier's instructions.

If you cannot reach your gas supplier, call the fire department.

Installation and service must be performed by a qualified installer, service agency or the gas supplier. (In Massachusetts, installation must be performed by a licensed installer / gas fitter.)

To reduce the risk of severe injury or death follow all installation instructions.

Do not install a clothes dryer with flexible plastic venting materials. If flexible metal (foil type) duct is installed, use duct that has been investigated and found acceptable for use with clothes dryers. Flexible venting materials are known to collapse, be easily crushed, and trap lint. These conditions will obstruct clothes dryer airflow and increase the risk of fire.

Save these instructions.

For Your Safety

Do not store or use gasoline or other flammable vapors and liquids in the vicinity of this or any other appliance.

Instructions to be followed in the event the user smells gas and the "For Your Safety" caution above must be posted in a prominent location. The information to be posted shall be obtained by consulting with the local gas supplier.

Disposal of the packaging material

The packaging material protects the dryer from transport damage. The packaging materials used are selected from materials which are environmentally friendly for disposal and can therefore be recycled.

Recycling the packaging material reduces the use of raw materials in the manufacturing process and also reduces the amount of waste in landfill sites. Your dealer will take the packaging material away.

Disposing of your old machine

Old electrical and electronic machines often contain valuable materials. However, they also contain harmful substances which were essential for their correct functioning and safety. These could be hazardous to human health and to the environment if disposed of with household waste or if handled incorrectly. Therefore, please do not dispose of your old machine with household waste.

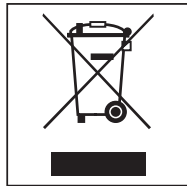

Please dispose of it at your local community waste collection/recycling center for electrical and electronic machines. Consult your dealer if necessary.

Please ensure that your old machine poses no risk to children while being stored for disposal.

Contents

Caring for the environment	3
IMPORTANT SAFETY INSTRUCTIONS	6
Appropriate use	6
Preventing misuse	6
Technical safety	7
Dryers with gas heating	9
Correct use	9
Accessories	10
Description of the machine	11
Operating the tumble dryer	12
Machines with residual moisture control (ROP)	12
Drying levels	12
Drying programs	12
How the control field works	13
Indicators	14
Before using for the first time	15
Drying	16
1. Notes on correct laundry care	16
Washing before drying	16
Removing foreign objects	16
Care symbols	16
2. Loading the tumble dryer	17
3. Selecting a program	17
Selecting a program	17
Drying level for programs with a selectable drying level	17
Time-controlled and other programs	18
Selecting Delay Start	18
4. Starting a program	19
5. End of program – removing the laundry	19
End of program	19
Removing the laundry	19
Care notes	20
Changing the program sequence	21
Changing a program once it has started	21
Adding laundry	21
Time left	22
Supervisor level (programming mode)	23
Requirements for accessing supervisor level	23
Accessing supervisor level	23
Quitting programming mode	23
Cleaning and care	24
Cleaning the lint filter	24
Cleaning the drum and the outside of the casing	24
Additional annual cleaning	25
Technical Service	26
Contact in case of fault	26
Optional accessories	26

Installation	27
Installation requirements	27
General operating conditions	27
Transport.....	27
Installing the tumble dryer	27
Securing the machine	29
Electrical connection	29
Supply air, exhaust, and ventilation cross-sections	30
Supply air/exhaust air	30
Calculating the total length and diameter of a supply-air or exhaust pipe.....	30
Substitute duct lengths	31
Maximum permissible total ducting length	31
Room ventilation opening for air intake from the setup room.....	33
Supply connection for tumble dryers with a central fresh air intake.....	33
Exhaust connection.....	34
Steam connection (only for steam-heated variants).....	39
Hot water connection (only for hot water-heated variants).....	39
Gas connection (only for gas-heated variants)	39
Gas.....	40
Steam.....	47
Operating pressure values.....	47
Fitting information for steam and condensate hoses.....	47
Heater bank information	47
Steam valve for high-pressure steam – indirect	48
Hot water.....	48
Operating conditions.....	48
Heater bank information	48
Networking	50
Pairing instructions	50
Optional accessories	53
Cleaning set	53
Communication box.....	53
XKM 3200 WL PLT.....	53
Original spare parts and accessories	54
Technical data	55

IMPORTANT SAFETY INSTRUCTIONS

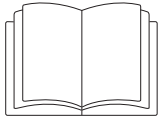

- ▶ It is essential to read these instructions.

This tumble dryer complies with all current local and national safety requirements. Inappropriate use can, however, lead to personal injury and material damage.

Read the Operating Instructions carefully before using the tumble dryer. They contain important information on safety, installation, use, and maintenance. This prevents both personal injury and damage to the tumble dryer.

In accordance with standard UL 1240 & CSA C22.2 No. 309; ANSI Z21.5.2 & CSA 7.2, Miele expressly and strongly advises that you read and follow the instructions in the chapter on installing the tumble dryer as well as the IMPORTANT SAFETY INSTRUCTIONS.

Miele cannot be held liable for injury or damage caused by non-compliance with these instructions.

Keep these Operating Instructions in a safe place and pass them on to any future user.

When instructing other people how to use the tumble dryer, they must be made aware of these IMPORTANT SAFETY INSTRUCTIONS.

Appropriate use

- ▶ The tumble dryer is designed for industrial use only.
- ▶ The tumble dryer is intended exclusively for drying textiles washed in water which have been labeled as suitable for tumble drying by the manufacturer on the care label. Any other applications may be dangerous. Miele cannot be held liable for damage resulting from incorrect or improper use or operation.
- ▶ This tumble dryer is not intended for outdoor use.
- ▶ Do not install the tumble dryer in a room where there is a risk of frost. At temperatures around freezing point, the tumble dryer may not be able to operate properly. The permitted room temperature is between 40°F and 95°F (2°C and 40°C).
- ▶ If the machine is operated in the commercial sector, it may only be operated by trained or qualified personnel. If the machine is operated in an unsecured location, the supervisor must ensure that its use does not pose a risk.
- ▶ The tumble dryer should only be used by people with reduced physical, sensory, or mental capabilities, or lack of experience or knowledge, if they are supervised while using it or have been shown how to use it in a safe way and understand and recognize the consequences of incorrect operation.
- ▶ Children must be kept away from the tumble dryer.
- ▶ Uses other than those listed above are not recommended and shall release the manufacturer from liability.

Preventing misuse

- ▶ Do not make any alterations to the tumble dryer, unless authorized to do so by Miele.
- ▶ Do not lean on the dryer door. Otherwise, the tumble dryer may tip over, causing injury to yourself or others.
- ▶ Do not use a pressure washer or hose to clean the tumble dryer.
- ▶ To ensure the correct performance of the tumble dryer and to prevent malfunctions and fire hazards, it is important to carry out maintenance on a regular basis.

IMPORTANT SAFETY INSTRUCTIONS

- ▶ Do not store or use gasoline, petrol, paraffin, or other highly flammable liquids near the tumble dryer. Risk of fire and explosion.
- ▶ Do not expose the tumble dryer to air which contains chlorine, fluorine, or other solvent vapors. This contaminated air can cause a fire.
- ▶ To prevent the risk of fire, the following items must not be dried in the tumble dryer:
 - Items which have not been washed.
 - Items which have not been thoroughly cleaned and are still soiled with grease, oil, or other deposits (such as kitchen linens or cosmetics cloths with cooking oils, grease, lotions, etc). If items have not been thoroughly cleaned, there is a danger that they might ignite when heated, even after they have been removed from the tumble dryer at the end of the program.
 - Items (e.g., mops and floor cloths) that have been treated with inflammable cleaning agents or which contain residues of acetone, alcohol, benzene, petrol, kerosene, stain remover, turpentine, wax and wax remover, or other chemicals.
 - Items which have been soiled with hair lacquer, hair spray, nail polish remover, or similar substances.

Wash heavily soiled items thoroughly by increasing the amount of detergent and selecting a high washing temperature. If in doubt, wash the items several times.

▶ **Warning:** Never switch the tumble dryer off before the end of the drying program. If you absolutely must interrupt the program, remove all items immediately and spread them out to cool down.

Technical safety

- ▶ Before installing the dryer, check it for visible signs of damage. Do not install or use a damaged machine.
- ▶ Do not connect the dryer to the electrical supply by an extension cord (risk of fire due to overheating).
- ▶ Fire hazard due to controllable socket. This tumble dryer must not be connected to a controllable socket (e.g., a timer). There is a risk of the laundry self-igniting if the tumble dryer's cooling phase is interrupted.
- ▶ The electrical safety of this dryer can only be guaranteed when continuity is complete between it and an effective grounding system. It is essential that this standard safety requirement is observed and regularly tested. If in any doubt, please have the electrical installation inspected by a qualified electrician. Miele cannot assume responsibility for the consequences of an inadequate grounding system.
- ▶ Unauthorized repairs could result in unforeseen dangers for the user, for which Miele cannot accept liability. Repairs should only be carried out by a Miele authorized technician, otherwise any subsequent damage may not be covered by the warranty. Repair instructions can be requested from Miele.
- ▶ Faulty components should only be replaced by Miele original parts. Miele may only guarantee the safety standards of the machine when Miele replacement parts are used.
- ▶ In the event of a fault and for cleaning and care purposes, the tumble dryer must be disconnected from the power supply. The tumble dryer is only disconnected from the power supply, if:
 - the plug is withdrawn, or
 - the breakers are disconnected, or
 - the breakers have been completely removed.
- ▶ The tumble dryer may not be used in mobile installations (e.g., on ships).
- ▶ Follow the instructions in "Installation" and "Technical data".

IMPORTANT SAFETY INSTRUCTIONS

- ▶ The tumble dryer may only be operated when the ducting has been installed and the room is sufficiently ventilated in accordance with all local codes.
- ▶ The ducting must never be installed in any of the following flues or shafts:
 - Chimneys or smokestacks that are in use.
 - Shafts that are used to ventilate installation rooms with fireplaces.
 - Flues that are used by third parties.

Smoke or exhaust gas that is fed back into the flue or shaft may be toxic.

- ▶ Regularly check all components in the ducting (e.g., wall pipe, external grille, bends, elbows, etc.) to make sure that air can move through them and to ensure that they are working properly. Clean components when necessary. Lint deposits in the ducting system will prevent the air from being extracted properly and, as a result, will stop the tumble dryer from working properly.

If existing ducting is due to be used, it must be checked before being installed in the tumble dryer.

Low pressure must not occur in the ducting.

- ▶ There is a risk of suffocation and poisoning due to exhaust gases being sucked back if gas-powered flow heaters, gas-powered room heaters, coal-burning stoves with a flue connection, etc., are installed in the same room, in the same apartment, or in neighboring rooms and the negative pressure is 4 Pa or more.

The following measures for suitable room ventilation (examples) can help to prevent negative pressure in the installation area:

- Install vents that cannot be closed in the exterior walls.
- Use window switches so that the tumble dryer can only be switched on when a window is open.

Always seek approval from the appropriate authority (gas installer, chimney sweep, etc.) to confirm that the machine can be operated without risk and that negative pressure of over 4 Pa can be prevented.

- ▶ If multiple tumble dryers are to be connected to one exhaust air duct, a non-return flap must be installed directly on the duct for each tumble dryer.

If this requirement is not observed, the tumble dryers may be damaged and their electrical safety could be affected.

- ▶ The electrical plug must be easily accessible so that the tumble dryer can be disconnected from the power supply at any time. The operator must be able to check from any access point that the electrical plug is still removed.

- ▶ If the appliance is hard wired, protective measures must be made on site to disconnect the tumble dryer from the electrical supply.

- ▶ Do not block the gap between the bottom of the tumble dryer and the floor with toe-kicks, deep pile carpet, etc.

- ▶ Ensure that no closeable door, sliding door, or an oppositely hinged door is installed that would hinder the drum door being opened in any way.

- ▶ If the power cord is damaged, it should be replaced by a Miele authorized technician in order to protect the user from harm.

- ▶ The dryer, when installed, must be electrically grounded in accordance with local codes or, in the absence of local codes, with the National Electrical Code, ANSI/NFPA 70, or the Canadian Electrical Code, CSA C22.1.

- ▶ The dryer must not be installed or stored in an area where it will be exposed to water and/or weather.

- ▶ Caution: Label all wires prior to disconnection when servicing controls. Wiring errors can cause improper operation.

IMPORTANT SAFETY INSTRUCTIONS

Dryers with gas heating

- ▶ The installation must conform with local codes or, in the absence of local codes, with the National Fuel Gas Code, ANSI Z223.1/NFPA 54, or the Natural Gas and Propane Installation Code, CSA B149.1.
- ▶ The dryer and its manually operated appliance main gas valve must be disconnected from the gas supply piping system during any pressure testing of that system at test pressures in excess of 1/2 psi (3.5 kPa).
- ▶ The dryer must be isolated from the gas supply piping system by closing the equipment shutoff valve during any pressure testing of the gas supply piping system at test pressures equal to or less than 1/2 psi (3.5 kPa).
- ▶ A minimum 1/8-in NPT plugged tapping, accessible for test gauge connection, must be installed immediately upstream of the gas supply connection to the dryer.

Take these safety precautions if you smell gas

- Extinguish all flames immediately.
- Close the on-site gas shut-off device, the gas shut-off device on the gas meter or the main gas shut-off device immediately.
- Open all windows and doors immediately.
- Do not light any naked flames (e.g., matches or lighters).
- Do not smoke.
- If there is the smell of gas in a room, never enter the room with an open flame.
- Do not carry out any actions that will create electrical sparks (such as pulling out electrical plugs or pressing electrical switches or bells).
- If you cannot find the cause of the gas smell and all gas valves have been shut off, please call the gas supply company immediately.

If other persons are being shown how to operate the machine, they must be given and/or made aware of these important safety precautions.

Correct use

- ▶ Always close the drum door after each drying cycle. This is to avoid anyone or anything unexpected getting into the tumble dryer.
- ▶ Keep the room where the tumble dryer is located free from dust and lint. If the air that is taken into the machine contains dirt particles, this can cause blockages. A fault may then occur and there is a risk of fire.
- ▶ Never operate the tumble dryer without the lint filter or with a damaged lint filter. This could lead to malfunctions. Lint can clog the air passages, heating elements, and ducting, which could result in a fire. In this case, stop the tumble dryer immediately and replace the damaged lint filter.
- ▶ The lint filter must be cleaned on a regular basis.
- ▶ To ensure problem-free operation of the tumble dryer:
 - Remove the lint from the lint filter after every drying cycle.
 - In addition, the lint filter and the air passages must be cleaned when prompted by the display.
- ▶ Remove all items from the pockets of the laundry to be dried (e.g., lighters, matches, keys).
- ▶ The program finishes when the cooling phase starts. Many programs are followed by a cooling phase to ensure that the items are not too hot to handle when you remove them (this also reduces the risk of the laundry self-igniting). Always remove all items of laundry from the dryer immediately after the cooling phase.

IMPORTANT SAFETY INSTRUCTIONS

- ▶ Fabric softener and similar products must be used according to the instructions on the manufacturer's packaging.
- ▶ For machine parts made from stainless steel:
Avoid contact between stainless steel surfaces and liquid detergents or disinfecting agents which contain chlorine or sodium hypochlorite. These agents can cause corrosion on stainless steel.
Aggressive chlorine bleach vapors can also be corrosive.
Do not store open containers of these agents near the machines.

Accessories

- ▶ Only use genuine Miele spare parts and accessories with this machine. Using parts or accessories from other manufacturers may invalidate the warranty, and Miele cannot accept liability.

 Miele cannot be held liable for damage caused by failure to comply with these IMPORTANT SAFETY INSTRUCTIONS.

Description of the machine

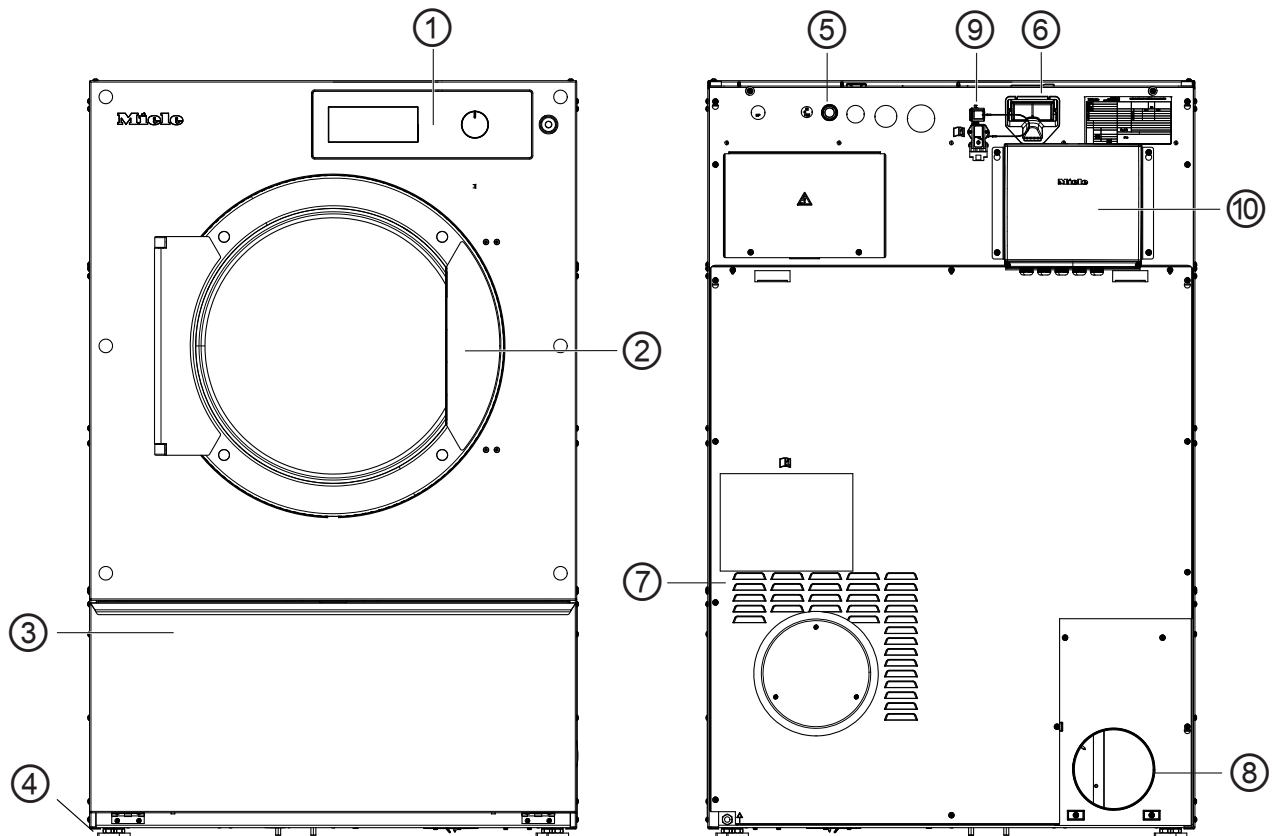

- ① Control panel with Program selector
- ② Door
- ③ Lint filter flap
- ④ 4 height-adjustable screw feet
- ⑤ Electrical connection
- ⑥ Communication module slot
- ⑦ Intake vents for drying air
- ⑧ Exhaust duct
- ⑨ Connection for communication box
- ⑩ Communication box (optional)
For setting up a connection with external systems

Operating the tumble dryer

Machines with residual moisture control (ROP)

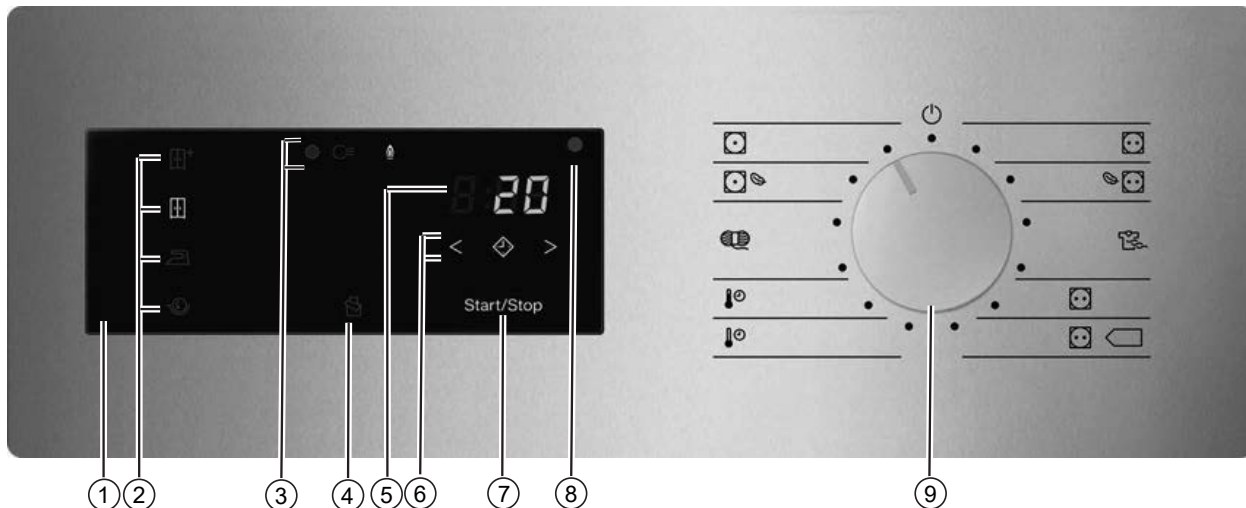

① Control field

② Sensor buttons for the drying levels

③ status displays

Light up when necessary





④ sensor button

For drying bedding.

⑤ Time display *8:88*

Displays the remaining program runtime in hours and minutes.

⑥ sensor buttons

For time selection. After touching the  sensor button, a later start time for the program (Delay Start) can be selected. The  sensor button lights up brightly when selected. The duration of the Delay Start period is selected by touching the  or  sensor button.

⑦ Start/Stop sensor control

For starting the selected drying program and canceling a program once it has started. The program selected can be started as soon as the sensor control starts flashing.





⑧ Optical interface

Used for data transfer by Miele Service.

⑨ Program selector















For selecting programs and for switching the machine off. The tumble dryer is switched on when you select a program and switched off by turning the program selector to the  position.

Drying levels

-  sensor button = “Normal+” drying level
-  sensor button = “Normal” drying level
-  sensor button = “Hand iron” drying level
-  sensor button = “Machine iron” drying level
-  sensor button: “Bedding” function

Drying programs

-  position = “Cottons” program

- For drying cotton and linen fabrics
 -   position = program “Cottons Low temperature”
- For drying delicate cotton and linen fabrics
 -  position = “Synthetics/Delicates” program
- For drying synthetic fibers and artificial silk to 20% residual moisture
 -  PRO position = “Label program” program
 -   position = “Label program” program
-   position = “Timed Drying, cool air” program
 - For airing fabrics with 10 minutes of drying time
-   position = “Timed Drying, warm air” program
 - For drying fabrics at high temperatures and with 20 minutes of drying time
-  position = “Woolens” program
 - For drying woolens with 5 minutes of drying time
-   position = “Minimum Iron Low temperature” program
-  position = “Minimum Iron” program
-  position = Machine off

How the control field works

The sensor buttons react to fingertip contact. Selection is possible as long as the respective sensor button is lit.







If a sensor button is brightly lit, this means it is currently selected

If a sensor button is dimly lit, this means it can be selected









Sensor buttons for the drying levels

After selecting a drying level program with the program selector, the recommended drying level lights up. Drying levels that can be selected are dimly lit.









Drying levels

-   sensor button = “Normal+” drying level
-   sensor button = “Normal” drying level
-  sensor button = “Hand iron” drying level
-   sensor button = “Machine iron” drying level

Temperature settings (TOP)





-   sensor button = “High” temperature setting
-   sensor button = “Medium” temperature setting
-   sensor button = “Low” temperature setting
-   sensor button = “Cool” temperature setting

Drying levels in payment system operation

-   sensor button = “High” temperature setting
-   sensor button = “Medium” temperature setting
-   sensor button = “Low” temperature setting
-   sensor button = “Cool” temperature setting

Operating the tumble dryer

Indicators

-  indicator light: Lights up when the lint filter needs cleaning.
-  indicator light: Lights up if a fault is present in the ducting.
-  indicator light (gas-heated machines only): Lights up when the heating is active.
-  indicator light (machines with payment system only): Lights up when payment has been made.
- *8:88* time display: The remaining program runtime is displayed in hours and minutes. With most programs, the runtime displayed may vary or “jump”. The following factors, among others, affect the program runtime displayed: the quantity of laundry, the type of fabric, and the residual moisture in the laundry. The electronic adapts to these parameters and then adjusts the program runtime with increasing accuracy.

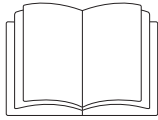

 Risk of injury or damage to property due to improper installation. Incorrect installation of the tumble dryer can lead to personal injury or damage to property.

Before commissioning the tumble dryer for the first time, make sure it has been installed and connected correctly.

See the information in the section on “Installation”.

Complete the initial commissioning process. During the initial commissioning process, you will need to define the settings for daily use of the tumble dryer. Some settings can only be modified during the initial commissioning process. After that, they can only be changed by Miele Service.

Drying

1. Notes on correct laundry care

Washing before drying

Heavily soiled laundry must be washed particularly thoroughly. Use sufficient detergent and select a high wash temperature. If in doubt, wash the items several times.

The tumble dryer must not be used for drying items of laundry which have been cleaned using industrial chemicals.

New, dark, and colored items must be washed thoroughly and separately. Do not dry dark and colored items with light-colored garments. There is the risk of colors running and discoloring other garments or even plastic components in the tumble dryer. Dark-colored fibers can also settle on light-colored garments and vice versa.

Removing foreign objects

Before drying, ensure that there are no foreign objects in the laundry.

 Damage due to foreign objects which were not removed from the laundry.

Foreign objects in the laundry can melt, burn, or explode.

Ensure that any foreign objects (e.g., detergent dispensing aids, lighters, etc.) have been removed from the laundry.







Check seams and stitching to ensure that padding and linings are intact. This way you will avoid the danger of filling coming out and causing a fire. Sew in or remove underwiring from bras.

 Risk of fire due to incorrect use and operation.

The laundry can burn and destroy the tumble dryer and the surroundings.

Read and observe the "IMPORTANT SAFETY INSTRUCTIONS".

Care symbols

Drying	
	Normal/higher temperature
	Low temperature*
* Select Low temperature.	
	Do not tumble dry
Ironing	
	Very hot
	Hot
	Warm
	Do not iron

2. Loading the tumble dryer

Loading the laundry

⚠ Damage to fabrics caused by incorrect laundry care. Incorrect laundry care can damage fabrics during tumble drying. Before loading, read “1. Notes on correct laundry care”.

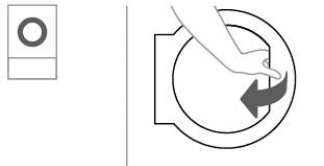

- Open the door.

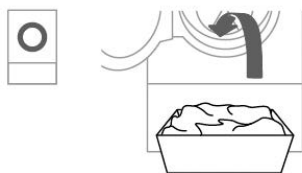

- Load the laundry.

Do not overload the drum. Overloading can cause unnecessary wear and tear to the laundry and cause a disappointing drying result. It can also cause more creasing.

Closing the door

⚠ Damage caused by laundry getting trapped. Laundry can be damaged by getting trapped when closing the door. When closing the door, make sure that laundry does not get trapped in the door opening.

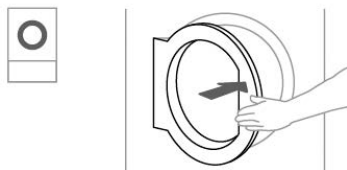

- Shut the door gently.

3. Selecting a program

Selecting a program

The tumble dryer is switched on when you select a program and switched off by turning the program selector to the ⏻ position.

- Turn the program selector to the required program.

A drying level may light up and runtimes will appear on the time display.

Drying level for programs with a selectable drying level

The preset drying level can be changed if required.

- Touch the sensor button for the drying level you want. It will then light up brightly.

Drying

The drying levels that are available for selection depend on the selected program.

Time-controlled and other programs

Time Dry

You can set the runtime in minute increments from *0:20* minutes to *2:00* hours.





- Touch the < or > sensor button repeatedly until the required program runtime appears on the time display.

The drying result is preset by the dryer and cannot be altered.

Selecting Delay Start

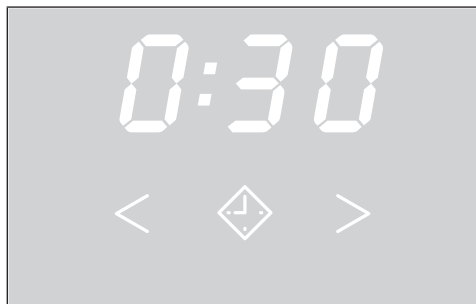
You can delay the start of a program from *0:30* minutes up to *24h* (hours).



- Touch the  sensor button.
 will light up brightly.
- Touch the > or < sensor button repeatedly until the required Delay Start time appears on the time display.

Tip: The times will count up and down automatically if you keep your finger on the > or < sensor button.

Changing Delay Start

- Touch the *Start/Stop* sensor button.
 - Touch the > or < sensor button repeatedly until the required Delay Start time appears on the time display.
 - Touch the *Start/Stop* sensor button.
- Delay Start continues to count down.

Cancelling/deleting Delay Start

- Turn the program selector to the  position. Alternatively, you can also cancel Delay Start by opening the door.

Delay Start count-down

- Delay Start times of more than *10h* will count down in hours and then in minutes until the start of the program.

- The drum will turn briefly every hour until the start of the program to reduce laundry creasing.

4. Starting a program

Starting a program ■ Touch the flashing *Start/Stop* sensor button.

The *Start/Stop* sensor button will light up.

Program sequence

- If Delay Start has been selected, the Delay Start period will start to count down first.
- With a longer Delay Start time, the drum will rotate occasionally to untangle the laundry. This will loosen the laundry.
- The program starts.

Program runtime/
estimated time re-
maining

The program runtime depends on the quantity of laundry, the type of fabric, and the residual moisture in the laundry. The displayed program duration for drying level programs can therefore vary or “jump”. The tumble dryer’s electronic adapts during the ongoing drying program. The displayed program runtime becomes more and more accurate.

When using the programs for the first time, the displayed time sometimes deviates significantly from the real time left. The difference between the estimated and achieved time becomes smaller if the corresponding program is run more often. If different load sizes are dried in one program, the time left display can only show an approximate time.

Laundry items and fabrics can wear out unnecessarily.
Avoid overdrying items of laundry and garments.

Energy saving

After a programmed time, the indicators dim. The *Start/Stop* sensor button will flash slowly.

- Touch the *Start/Stop* sensor button to switch on the indicators. Energy saving for the indicators will not affect a running program.
- Before the program finishes, the laundry is cooled.

5. End of program – removing the laundry

End of program

The laundry will be cooled down shortly before the end of the program. The laundry can now be unloaded.

The program is finished when only *0:00* is visible in the display.

If *Anti-crease* (see “Programmable functions”) has been selected, the drum rotates at intervals. This reduces creasing if the laundry cannot be unloaded straight away.

The tumble dryer will switch off automatically after the programmed time after the end of a program.

Drying

Removing the laundry

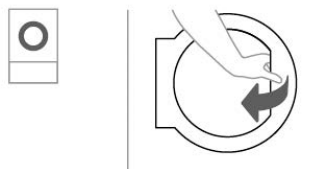

- Open the door.

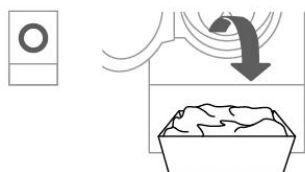

- Remove all of the laundry from the drum.

⚠ Damage caused by overdrying.
Laundry left in the dryer can be damaged by overdrying.
Always remove all items from the drum once drying has finished.

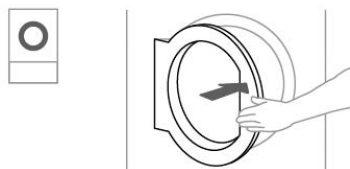

- Close the door.
- Switch the tumble dryer off.



Care notes

This tumble dryer requires regular maintenance, particularly if it is used on a continuous basis. Please see “Cleaning and care” for details.

Changing a program once it has started

You cannot change to another program once a program has started (this prevents unintentional alterations). You will need to cancel the current program before you can select a new one.

 Risk of fire due to incorrect use and operation.
The laundry can burn and destroy the tumble dryer and the surroundings.
Read and observe the “IMPORTANT SAFETY INSTRUCTIONS”.

If you adjust the program selector, the  symbol will light up in the time display. The  symbol goes out when you select the original program.

Canceling the current program

- Touch the *Start/Stop* sensor button for more than 2 seconds.

The items will be cooled down, depending on the temperature reached and how long they have been dried for.

 will light up if you press the *Start/Stop* sensor button again during the cooling-down phase.

- Open the door.
- Close the door.
- Turn the program selector to another program.
- Touch the *Start/Stop* sensor button.

Selecting another program

Adding laundry

- Open the door.

 Risk of burns by touching hot laundry or the drum.
The laundry and the tumble dryer drum are still hot and can cause burns if they are touched.
Let the laundry cool down and remove it carefully.

- Add items.
- Close the door.
- Start the program.

Adding laundry during ongoing Delay Start period

You can open the door to add or remove laundry.

- All program settings will be saved.
- You can still change the drying level, if required.

- Open the door.
- Remove or add the laundry.
- Close the door.
- Touch the *Start/Stop* sensor button so that the Delay Start period continues.

Changing the program sequence

Time left

Altering the program sequence can cause the program duration shown in the display to be adjusted.

Supervisor level (programming mode)

Requirements for accessing supervisor level

- The machine is switched on.
- The door is open.

Accessing supervisor level

- Touch and hold the *Start/Stop* sensor control and close the door.

The *Start/Stop* sensor control flashes rapidly for 2 seconds.

- Release the *Start/Stop* sensor control.
- Touch the *Start/Stop* sensor control for at least 4 seconds.

The *Start/Stop* sensor control will light up constantly. This indicates that you have successfully accessed the supervisor level programming mode.

- Release the *Start/Stop* sensor control.

If the illuminated *Start/Stop* sensor control is not released again within 6 seconds, the machine will detect an accessing error or a door jam.

The maximum time for the access attempt is 10 seconds. The attempt will then be cancelled automatically.

Quitting programming mode

- To quit programming mode, turn the selector dial on the dryer to the  position.

The dryer will be switched off.

Cleaning the lint filter

 Risk of fire if the tumble dryer is operated without a lint filter. If there is no lint filter, the air channels, heating elements, and ducting can become clogged during drying and may catch fire. The lint filter must not be removed for cleaning. Never operate the tumble dryer without the lint filter in place. Replace a damaged lint filter immediately.

A lint filter collects lint released by textiles. The lint filter must be cleaned at least once every working day as well as whenever a prompt to clean it appears in the display. In the event of a heavy build-up of lint, the lint filter should be cleaned several times per day.

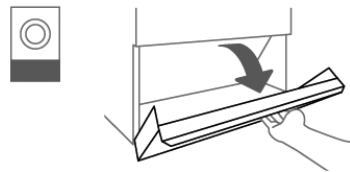

- Open the lint filter compartment cover.

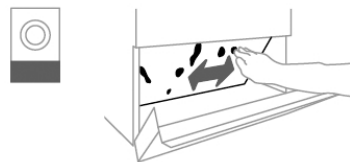

- Remove the lint from the lint filter using your hands.

Do not use pointed or sharp-edged objects to clean the lint filter. Otherwise, the lint filter may become damaged.

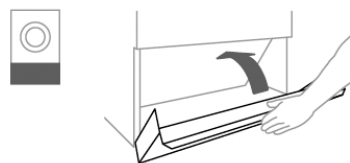

- Close the lint filter compartment cover after cleaning the lint filter.

Cleaning the drum and the outside of the casing

 Risk of death due to electric shock. The tumble dryer must be completely disconnected from the electricity supply before performing cleaning or maintenance work. Before starting cleaning or maintenance work, always switch off the tumble dryer at the circuit breaker (on site). Do not use a pressure washer or hose to clean the tumble dryer.

- Clean the tumble dryer casing, control field, and plastic parts with a **mild** cleaning agent or with a soft, damp cloth only. Then rub the tumble dryer casing, control field, and plastic parts dry.

Abrasive cleaning agents must not be used to clean the tumble dryer.

- The tumble dryer drum must be wiped clean with a soft, damp cloth after drying items that have been starched.
- Check the seal.
- Check the latches on the drum door and lint filter compartment cover.

The air intake vent is located on the rear of the tumble dryer. This vent must never be covered or blocked with objects. Keep the area around the tumble dryer – in particular the air intake – clear of lint.

Additional annual cleaning

Miele Technical Service or a trained specialist must check the interior of the tumble dryer and the ducting for lint deposits **once per year** and clean the machine if necessary. In the case of electrically-heated tumble dryers, the heater bank and the heating shaft must also be checked by Miele Technical Service Department. In the case of gas-heated dryers, the burner and the burner area must be checked.

Technical Service

Contact in case of fault

In the event of a fault which you cannot remedy yourself, please contact your Miele dealer or Miele Technical Service.

Contact information for Miele Technical Service can be found at the end of this document.

Please quote the model and serial number of your appliance when contacting Miele. Both pieces of information can be found on the data plate.

Optional accessories

Optional accessories for this tumble dryer are available from your Miele dealer or from Miele Customer Service.

Installation requirements

⚠ Risk of injury or damage to property due to improper installation.

Incorrect installation of the tumble dryer can lead to personal injury or damage to property.

It is recommended that installation and commissioning be accomplished by Miele Service or an authorized dealer.

- ▶ The tumble dryer must be installed in accordance with all relevant regulations and standards. Observe all local codes.
- ▶ The dryer must only be operated in a room that has sufficient ventilation and which is frost-free.
- ▶ The tumble dryer must not be installed behind a closeable door or a sliding door. The maximum opening angle of the tumble dryer door must not be limited by objects or doors. It must be possible to fully open the tumble dryer door at any time.

General operating conditions

This dryer is intended only for use in a commercial environment and must only be operated indoors.

Do not install the tumble dryer in a room where there is a risk of frost.

Depending on the nature of the installation site, sound emissions and vibration may occur.

Tip: Have the installation site inspected and seek the advice of a professional in instances where increased noise may cause a nuisance.

Transport

The tumble dryer must not be transported without a transport pallet. Suitable transport aids must always be used during transportation.

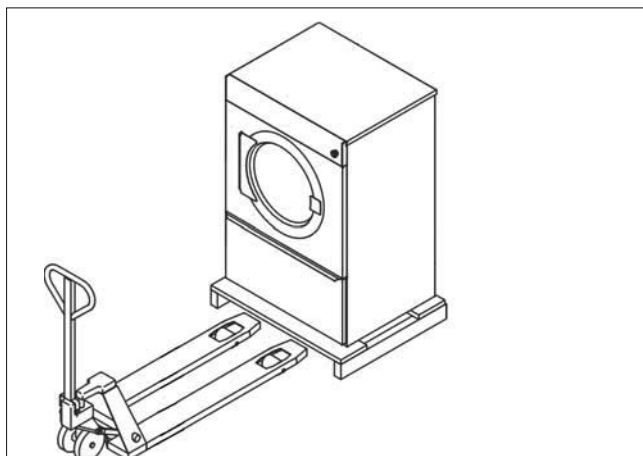

At the installation site, the tumble dryer must be lifted from the transport pallet using suitable lifting gear.

Installing the tumble dryer

- Place the tumble dryer on a perfectly level, secure, and horizontal surface that is able to withstand the specified floor load.

The floor load created by the tumble dryer is concentrated and transferred to the installation surface via the screw feet. A base is not required. However, an uneven floor surface must be compensated for.

Installation

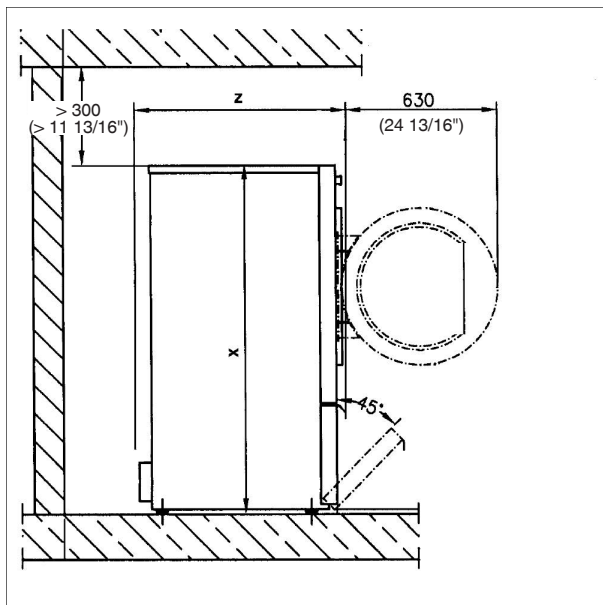
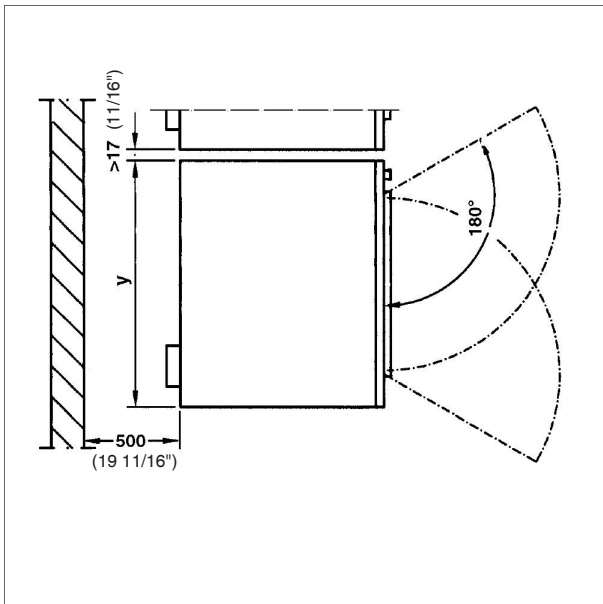

	PDR 514/518/522/914/918/922	PDR 528/544/928/944
x	55 1/8" (1,400 mm)	64 9/16" (1,640 mm)
y	35 11/16" (906 mm)	47 1/2" (1,206 mm)
z	PDR 514/914: 33 9/16" (852 mm) PDR 518/918: 40 3/4" (1,035 mm) PDR 522/922: 45 13/16" (1,164 mm)	PDR 528/928: 40 1/16" (1,018 mm) PDR 544/944: 54 1/2" (1,384 mm)

- To facilitate any future maintenance work, a maintenance corridor with a width of at least 19 11/16" (500 mm) must be set up behind the machine and must be accessible at all times. The distance between the machine and any walls must not fall below the specified minimum values.
- Adjust the tumble dryer screw feet until the machine is level. After the machine has been aligned, screw the washers tightly to the base plate using a screwdriver.

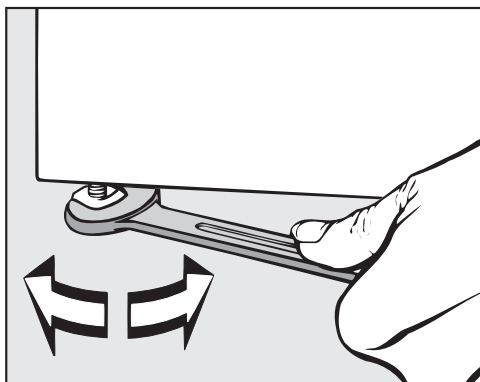

Tip: Use a level to ensure correct alignment.

Securing the machine

- The tumble dryer must be secured to the floor by installing the tensioning strips supplied over the machine feet.

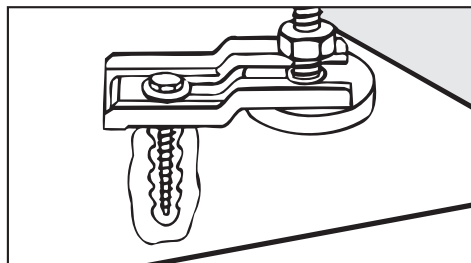

The material provided is intended for use in bolting the machine to a concrete floor. If other floor types are present at the installation site, the fastening material must be ordered separately.

Electrical connection

The electrical connection must be established by a qualified electrician.

- ▶ The machine must only be connected to an electrical supply provided in accordance with local codes and standards. Please also observe the regulations set out by your insurance provider and energy supplier, accident prevention regulations, as well as recognized codes of practice.
- ▶ Reliable and safe operation of this tumble dryer is only ensured if it has been connected to the electricity supply.

The required supply voltage, power rating, and fuse rating can be found on the data plate on the tumble dryer. Ensure that the supply voltage matches the voltage quoted on the data plate before connecting the machine to the electricity supply.

Connection to a supply voltage other than the one quoted on the data plate can damage the tumble dryer if the voltage is too high.

- ▶ If more than one voltage is specified on the data plate, the tumble dryer can be converted for connection to the relevant input voltage. This conversion must be performed by Miele Customer Service or by an authorized dealer. During the conversion, the wiring instructions given on the wiring diagram must be followed.

The tumble dryer can either be hard-wired or connected using a plug-and-socket connection in accordance with IEC 60309-1. For a hard-wired connection, an all-pole disconnect switch must be available at the installation site.

Installation

A disconnect switch is a switch which ensures a contact opening of more than 1/8" (3 mm). These include circuit breakers, breakers, and contactors (IEC/EN 60947).

If the power supply cannot be permanently disconnected, the disconnect switch (including plug and socket) must be safeguarded against being switched on either unintentionally or without authorization.

Tip: We recommend connecting the tumble dryer to the power supply via a plug and socket so that it is easier to conduct electrical safety checks (e.g., during maintenance or repair work).

► The tumble dryer must not be connected to devices such as timers which would switch it off automatically.

Limitations to dryer operation due to reconnecting/removing jumpers.

Modifying/removing jumpers at the heater elements in order to set lower heater ratings may result in limitations to dryer operation. Depending on the type of laundry, length of vent ducting, and outside temperature, the desired drying results may no longer be achieved. In the event of a reduction, the specified consumption data will no longer be achieved.

► If it is necessary to install a residual current device (RCD) in accordance with local regulations, a residual current device type B (sensitive to universal current) must be used.

► After installing the tumble dryer, equipotential bonding must be established. The equipotential bonding must comply with the local and national installation specifications.

Supply air, exhaust, and ventilation cross-sections

Supply air/exhaust air

The tumble dryer may only be operated when the ducting has been connected properly and the room is sufficiently ventilated.

Calculating the total length and diameter of a supply-air or exhaust pipe

The length of the required ductwork and the number and shape of the elbows are determined by the structural conditions on-site. In order to maximize the airflow efficiency, the pipeline should be as short as possible and contain few or minimal elbows.

⚠ The exhaust ducting must not be made from flammable materials.

Otherwise there is a risk of fire.

Use only non-flammable materials for the exhaust ducting. All local regulations for metallic ducting must be observed. Plastic must not be used for ventilation.

In upward exhaust ducting systems, a condensate drain must be fitted to the bottom. The condensate must be drained via a water collection tray or a floor drain positioned in an appropriate location.

If air is being directed from multiple appliances into a combined line (exceptional circumstances), a non-return device (non-return flap) must be installed in each separate line to prevent backflow.

To make subsequent cleaning of the pipes easier, cleaning flaps should be fitted to elbows wherever possible.

The on-site exhaust ducting and venting to the outdoors must be regularly checked for lint deposits and cleaned if necessary.

Substitute duct lengths

Type of elbow	Type	PDR 914/514	PDR 918/518	PDR 922/522	PDR 928/528	PDR 944/544
	90° elbow 45° elbow	$r = 2d$ $r = 2d$		3' 7 5/16" (1.1 m) 2' 3 9/16" (0.7 m)		
	90° elbow 45° elbow	$r = d$ $r = d$		6' 2 13/16" (1.9 m) 3' 7 5/16" (1.1 m)		
	90° concertina duct elbow 45° concertina duct elbow	$r = 2d$ $r = 2d$		10' 6" (3.2 m) 6' 6 3/4" (2 m)		
	90° segmented elbow (3 welded seams)	$r = 2d$		3' 11 1/4" (1.2 m)		
	90° elbow, Westaflex ducting 45° elbow, Westaflex ducting	$r = 2d$ $r = 4d$ $r = 2d$ $r = 4d$		3' 11 1/4" (1.2 m) 2' 11 7/16" (0.9 m) 3' 3 3/8" (1 m) 2' 7 1/2" (0.8 m)		
	Non-return flap	39' 4 7/16" (12 m)	39' 4 7/16" (12 m)	22' 11 9/16" (7 m)	22' 11 9/16" (7 m)	21' 3 7/8" (6.5 m)

Table 1

Maximum permissible total ducting length

Internal minimum pipe diameter (metal ducting)	PDR x14	PDR x18	PDR x22	PDR x28	PDR x44
5 7/8" (150 mm)	62' 4 1/16" (19 m)	49' 2 9/16" (15 m)	39' 4 7/16" (12 m)	32' 9 11/16" (10 m)	32' 9 11/16" (10 m)
7 1/16" (180 mm)	164' 1/2" (50 m)	124' 8 1/16" (38 m)	101' 8 1/2" (31 m)	88' 7" (27 m)	78' 8 7/8" (24 m)
7 7/8" (200 mm)	278' 10 7/16" (85 m)	213' 3 1/16" (65 m)	173' 10 5/8" (53 m)	157' 5 3/4" (48 m)	130' (40 m)
Permissible counter pressure in the exhaust ducting	EL: 0.05 psi (220 Pa)	EL: 0.05 psi (340 Pa)	EL: 0.05 psi (350 Pa)	EL: 0.06 psi (410 Pa)	EL: 0.04 psi (310 Pa)
EL: electrically heated	G: 0.04 psi (280 Pa)	G: 0.04 psi (290 Pa)	G: 0.04 psi (290 Pa)	G: 0.04 psi (290 Pa)	G: 0.03 psi (240 Pa)
G: gas-heated	SI/HW: -	SI/HW: 0.03 psi (200 Pa)	SI/HW: 0.04 psi (310 Pa)	SI/HW: 0.07 psi (510 Pa)	SI/HW: 0.06 psi (390 Pa)
SI/HW: steam-heated/hot water-heated					

Table 2

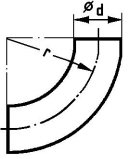
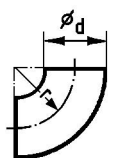
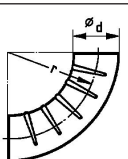
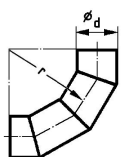
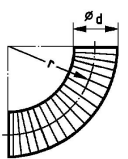
When connected to the vent ducting through the exhaust duct of a machine, particular care must be taken to make sure the connection is secure and air-tight.

Installation

With complex ducting with many bends and additional components, or when several different machines are connected to a shared duct, it is recommended that a detailed pipework calculation is carried out by a qualified specialist.

The vent ducting must not be channeled into a chimney or flue already in use for any gas-, coal-, or oil-burning installation. The warm and moist exhaust air is to be conducted outside or to a suitable venting duct over the shortest path possible. The vent ducting must be laid so that air flow is not hindered. To achieve this, use as few bends as possible along with short pipelines and well-made connections and transitions checked for air-tightness. No filters or grilles may be fitted in the vent ducting.

The end of the vent ducting leading out into the open should be protected against the elements, e.g., with a downward-facing 90° bend.

 During tumble dryer operation, the room must be adequately ventilated.

Room ventilation opening for air intake from the setup room

The minimum dimension of the ventilation opening depends on the cross-section of the vent duct.

Vent duct			Minimum dimension for ventilation opening		
⊘	□	A	A	⊘	□
6" (150 mm)	-	27 7/16" ² (177 cm ²)	82 5/16" ² (531 cm ²)	10 1/4" (260 mm)	9 1/16" (230 mm)
-	6" (150 mm)	34 7/8" ² (225 cm ²)	104 5/8" ² (675 cm ²)	11 5/8" (295 mm)	10 1/4" (260 mm)
7 1/16" (180 mm)	-	39 3/8" ² (254 cm ²)	118 1/8" ² (762 cm ²)	12 3/8" (315 mm)	11" (280 mm)
-	7 1/16" (180 mm)	50 1/4" ² (324 cm ²)	150 11/16" ² (972 cm ²)	14" (355 mm)	12 3/8" (315 mm)
7 7/8" (200 mm)	-	48 11/16" ² (314 cm ²)	146" ² (942 cm ²)	13 3/4" (350 mm)	12 3/16" (310 mm)
-	7 7/8" (200 mm)	62" ² (400 cm ²)	186" ² (1,200 cm ²)	15 9/16" (395 mm)	13 3/4" (350 mm)
8 11/16" (220 mm)	-	58 7/8" ² (380 cm ²)	176 11/16" ² (1,140 cm ²)	15" (381 mm)	14 13/16" (377 mm)
-	8 11/16" (220 mm)	75" ² (484 cm ²)	225 1/16" ² (1,452 cm ²)	16 15/16" (430 mm)	15 1/16" (382 mm)
9 13/16" (250 mm)	-	76 1/8" ² (491 cm ²)	228 5/16" ² (1,473 cm ²)	17 1/8" (435 mm)	15 3/16" (385 mm)
-	9 13/16" (250 mm)	96 7/8" ² (625 cm ²)	290 5/8" ² (1,875 cm ²)	19 5/16" (490 mm)	17 1/8" (435 mm)
11 3/16" (300 mm)	-	109 9/16" ² (707 cm ²)	328 3/4" ² (2,121 cm ²)	20 1/2" (520 mm)	18 1/8" (460 mm)
-	11 3/16" (300 mm)	139 1/2" ² (900 cm ²)	418 1/2" ² (2,700 cm ²)	23 1/4" (590 mm)	20 1/2" (520 mm)

Table 3

Supply connection for tumble dryers with a central fresh air intake

For steam-heated tumble dryers, having a central fresh air supply reduces lint build-up around the heater bank.

 Removing the protective cover exposes live parts.
Any work on the appliance may only be carried out by qualified personnel while the power is switched off.

A plastic or steel pipe must be installed from the tumble dryer's central fresh air intake over a minimum length of 3 ft. (900 mm). Each joint must be secured with 2 screws. The supply air pipe must not extend into the tumble dryer.

Installation

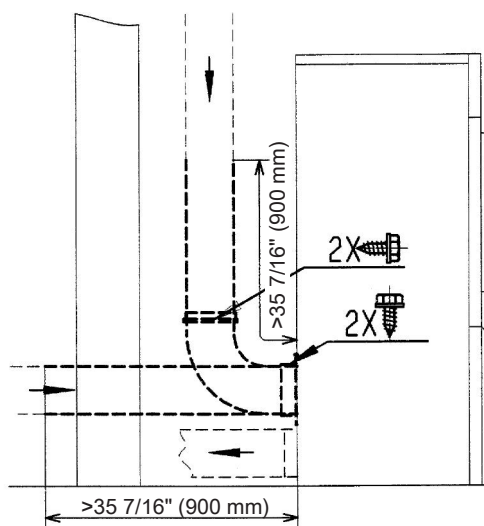
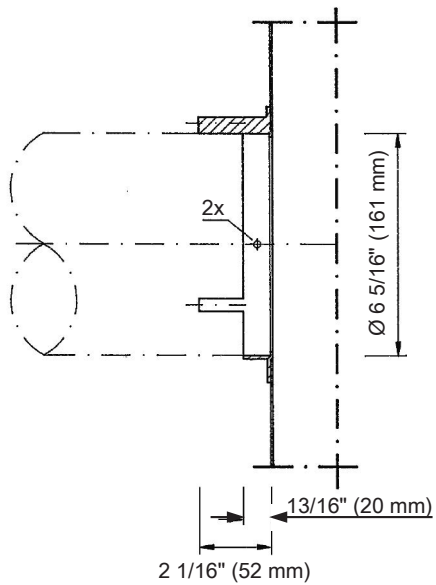

Exhaust connection

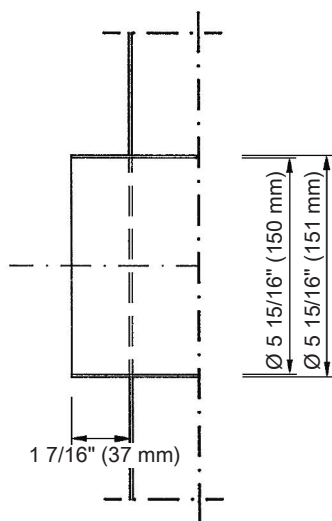

Example 1

Configuring vent ducting made from steel piping for the PDR 914/514 tumble dryers:

- L1, L2: each 9' 10" (3 m) steel piping
- B1, B2: each 90° concertina pipe elbow (r = 2d)
- B3: 90° elbow (r = d)

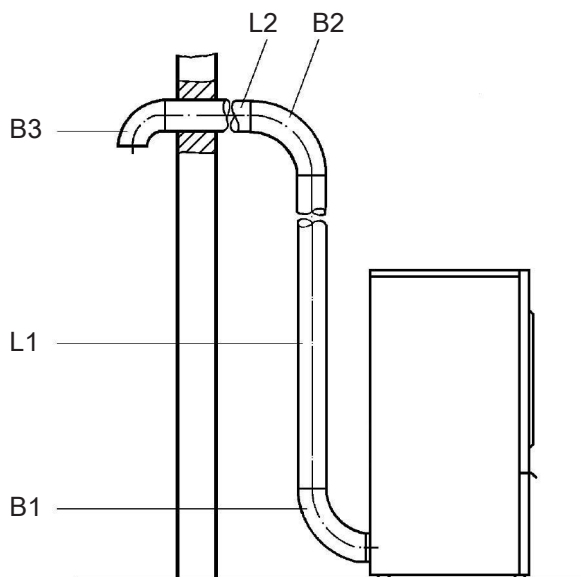

1. Total duct length

Steel pipe	L1 = 9' 10" (3.0 m)
Steel pipe	L2 = 9' 10" (3.0 m)
90° concertina pipe elbow (r = 2d)	B1 = 10' 6" (3.2 m)*
90° concertina pipe elbow (r = 2d)	B2 = 10' 6" (3.2 m)*
90° elbow (r = d)	B3 = 6' 3" (1.9 m)*
Total duct length	46' 11" (14.3 m)

* Substitute duct lengths according to **Table 1**

2. Duct diameter depending on total pipe length

For the calculated total pipe length of **46' 11" (14.3 m)** for a PDR 914/514, a minimum duct diameter of **6" (150 mm)** is specified for the exhaust ducting **according to Table 2**.

Installation

Example 2

Common combined exhaust ducting for multiple appliances should only be considered as a solution in exceptional cases.

Configuring combined exhaust ducting made from steel for the PDR 914/514 and PDR 918/518 series tumble dryers:

- L1–L4 each 6' 6" (2 m) steel piping
- B1–B3 each 90° concertina pipe elbow (r = 2d)
- B4 45° elbow (r = 2d)
- B5 90° elbow (r = d)

If the exhaust from multiple appliances is to be ducted into a combined line, a non-return device must be installed in each separate line to prevent backflow.

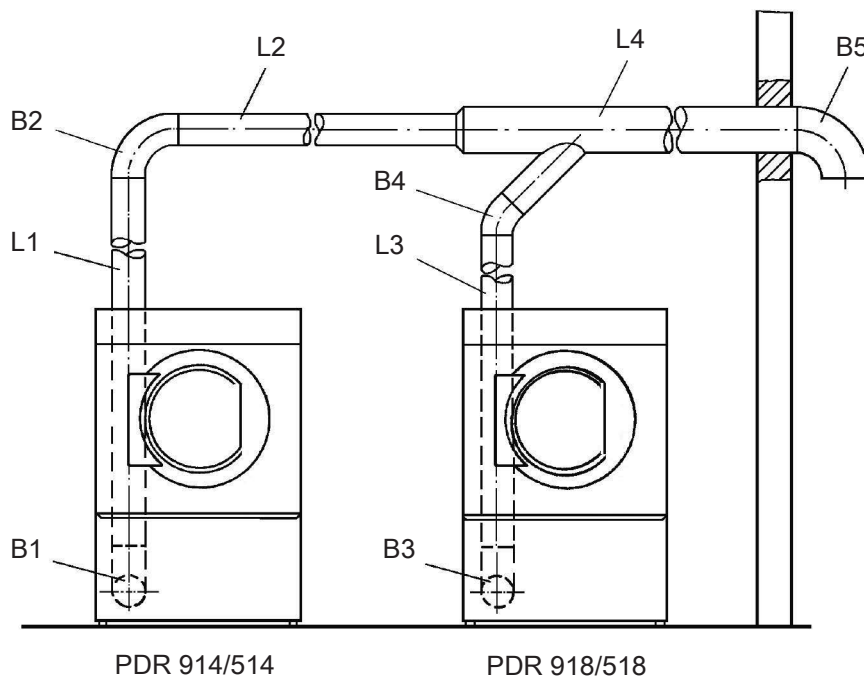

1. Total pipe length PDR 914/514

Steel pipe	L1 = 6' 6" (2.0 m)
Steel pipe	L2 = 6' 6" (2.0 m)
Steel pipe	L4 = 6' 6" (2.0 m)
90° concertina pipe elbow (r = 2d)	B1 = 10' 6" (3.2 m)*
90° concertina pipe elbow (r = 2d)	B2 = 10' 6" (3.2 m)*
90° elbow (r = d)	B5 = 6' 3" (1.9 m)*
Total duct length	46' 11" (14.3 m)

* Substitute pipe lengths according to **Table 1**

2. Pipe diameter depending on total pipe length

Total pipe length = **46' 11" (14.3 m)**

Maximum permissible total pipe length 62' 4" (19 m) = **Ø 6" (150 mm)** internal pipe diameter (see Table 2)

3. Total pipe length PDR 918/518

Steel pipe	L3 = 6' 6" (2.0 m)
Steel pipe	L4 = 6' 6" (2.0 m)
90° concertina pipe elbow (r = 2d)	B3 = 10' 6" (3.2 m)*
45° elbow (r = 2d)	B4 = 2' 3" (0.7 m)*
90° elbow (r = d)	B5 = 6' 2" (1.9 m)*
Total duct length	32' 1 13/16" (9.8 m)

* Substitute pipe lengths according to **Table 1**

4. Pipe diameter depending on total pipe length

Total pipe length = **32' 1 13/16" (9.8 m)** (PDR 918/518)

Maximum permissible total pipe length 49' 2" (15 m) = **Ø 6" (150 mm)** internal pipe diameter (see Table 2)

5. Total duct diameter

According to Table 3

Duct diameter PDR 914/514	Ø 6" (150 mm) = 27 3/8"² (177 cm²)
Duct diameter PDR 918/518	Ø 6" (150 mm) = 27 3/8"² (177 cm²)
Total cross section A	= 54 13/16"² (354 cm²)
Total duct diameter	= Ø 8 11/16" (220 mm)

Installation

Example 3

Configuring exhaust ducting and a supply pipe made from steel for the PDR 914/514 series tumble dryer:

- L1, L2: each 6' 6" (2.0 m) steel piping
- L3: 8' 2" (2.5 m) steel piping
- B1, B2: 90° concertina pipe elbow for each
- B3, B4: 90° elbow (r = d) for each

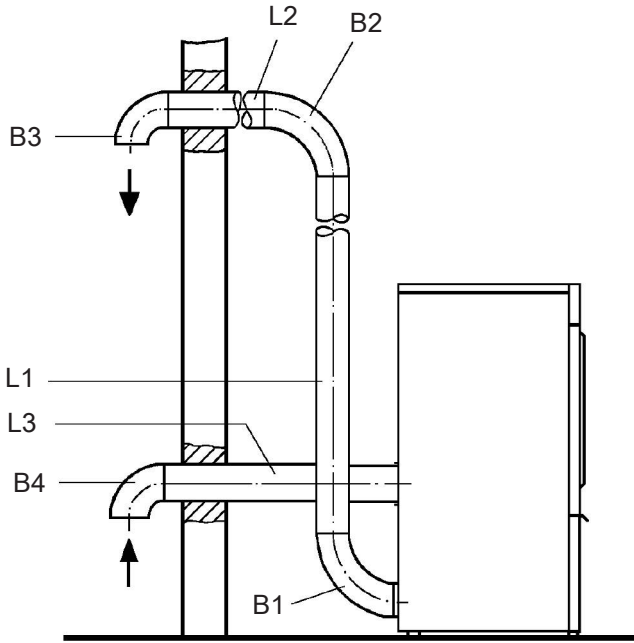

1. Total duct length

Steel pipe	L1 = 6' 6" (2.0 m)
Steel pipe	L2 = 6' 6" (2.0 m)
Steel pipe	L3 = 8' 2" (2.5 m)
90° concertina pipe elbow	B1 = 10' 6" (3.2 m)*
90° concertina pipe elbow	B2 = 10' 6" (3.2 m)*
90° elbow (r = d)	B3 = 6' 3" (1.9 m)*
90° elbow (r = d)	B4 = 6' 3" (1.9 m)*
Total duct length	54' 9 1/2" (16.7 m)

* Substitute pipe lengths according to **Table 1**

2. Pipe diameter depending on total pipe length

For the calculated total pipe length of **54' 9" (16.7 m)** for a PDR 914/514, a minimum pipe diameter of **6" (150 mm)** is specified for the exhaust ducting and supply pipe **according to Table 2**.

Configuring the room ventilation opening

⚠ Rooms in which rotary irons and tumble dryers are operated must have an induced ventilation system (e.g., ventilation slots in windows and doors, wall openings with grilles, or opened windows or skylights).

For example 1

A duct diameter of **6" (150 mm)** was specified in example 1. According to this duct diameter, a room ventilation opening with a size of **17' 5" (531 cm)** is required. The edge length is **9 1/16" (230 mm)** (see Table 3).

For example 2

A total duct diameter of **8 11/16" (220 mm)** was specified. According to this duct diameter, a room ventilation opening with a size of **37' 4" (1,140 cm)** is required. The edge length is **14 13/16" (377 mm)** (see Table 3).

For example 3

Since in this case the tumble dryer is connected to a central air supply, additional ventilation openings are not needed.

Steam connection (only for steam-heated variants)

The steam connection must only be carried out by an authorized installation technician. The enclosed installation instructions must be observed as they are important for the steam connection.

Hot water connection (only for hot water-heated variants)

The hot water connection may only be carried out by an authorized installation technician. The enclosed installation instructions must be observed as they are important for the hot water connection.

If a faucet is desired, it must be installed on site.

Gas connection (only for gas-heated variants)

The gas connection must only be carried out by an authorized installation technician in accordance with the applicable national regulations (see installation instructions).

The installation must conform with local codes or, in the absence of local codes, with the National Fuel Gas Code, ANSI Z223.1/NFPA 54, or the Natural Gas and Propane Installation Code, CSA B149.1

The dryer and its manually operated appliance main gas valve must be disconnected from the gas supply piping system during any pressure testing of that system at test pressures in excess of 1/2 psi (3.5 kPa).

The dryer must be isolated from the gas supply piping system by closing the equipment shutoff valve during any pressure testing of the gas supply piping system at test pressures equal to or less than 1/2 psi (3.5 kPa).

A minimum 1/8-in NPT plugged tapping, accessible for test gauge connection, must be installed immediately upstream of the gas supply connection to the dryer.

The use of a gas socket is not permitted at the specified heater rating as the flow rate is too low.

The gas heating is configured at the factory in line with the gas specifications on the sticker on the rear of the machine.

Installation

If the gas type is changed, a conversion kit must be requested from Miele Service (please specify the machine type, serial number, gas type, gas group, gas connection pressure, and country of installation). Follow the installation instructions. This conversion may only be carried out by an authorized specialist.

Gas

Take these safety precautions if you smell gas

- Extinguish all flames immediately.
- Close the on-site gas shut-off device, the gas shut-off device on the gas meter or the main gas shut-off device immediately.
- Open all windows and doors immediately.
- Do not light any naked flames (e.g., matches or lighters).
- Do not smoke.
- If there is the smell of gas in a room, never enter the room with an open flame.
- Do not carry out any actions that will create electrical sparks (such as pulling out electrical plugs or pressing electrical switches or bells).
- If you cannot find the cause of the gas smell and all gas valves have been shut off, please call the gas supply company immediately.

If other persons are being shown how to operate the machine, they must be given and/or made aware of these important safety precautions.

During installation, the technical regulations for gas installations as well as national and regional building regulations, fire regulations, and specifications from the relevant gas supply companies must be adhered to.

When planning a gas-heated system, contact the relevant gas supply company and a building regulations inspector.

1. What needs to be observed before commissioning

Please specify the gas type, gas group, and connection pressure.

Installation site

Gas-heated tumble dryers must **not** be operated in a room where cleaning machines operate with solvents containing perchloroethylene or CFCs. During combustion, any vapors that are emitted will break down into hydrochloric acid, leading to consequential damage affecting laundry and the machine. Air exchange must not take place if machines are set up in separate rooms.

Rooms with fuel-burning installations must be adequately aerated and ventilated. Any gas-heated machine must be considered to be a fuel-burning installation (regardless of its gas flow rate).

If liquid gas-heated machines are being set up below ground level, the operator must provide the system with the necessary aeration and induced ventilation equipment in accordance with technical regulations for liquid propane.

If no low pressure occurs when a full fire is burning in all fuel-burning installations, this means that the room ventilation is working properly, even if the exhaust gases from the installations are being extracted mechanically. This ensures that the gas is being combusted correctly and that the exhaust gases are being evacuated completely.

It must not be possible to seal off aeration and ventilation openings.

⚠ Before completing commissioning, maintenance, conversion, and repair work, all gas-conducting components – from the manual shut-off valve to the burner jet – must be checked for leaks.

Particular attention must be paid to the measuring stubs on the gas valve. Checks must be performed when the burner is both switched on and switched off.

- ▶ Installing thermal shut-off equipment on site is recommended.
- ▶ If gas-heated appliances are accessible to anyone, it is also necessary to check whether a gas flow monitor needs to be used.

Gas supply

Required flow rate

Appliance type	Rated heat load (Hi)	Natural gas	Liquid propane
PDR 914/514	15 kW	0.936 CFM (1.59 m ³ /h)	2.6 lb/h (1.18 kg/h)
PDR 918/518	18 kW	1.118 CFM (1.90 m ³ /h)	3.13 lb/h (1.42 kg/h)
PDR 922/522	21.5 kW	1.342 CFM (2.28 m ³ /h)	3.75 lb/h (1.70 kg/h)
PDR 928/528	30 kW	1.866 CFM (3.17 m ³ /h)	5.22 lb/h (2.37 kg/h)
PDR 944/544	36 kW	2.242 CFM (3.81 m ³ /h)	6.26 lb/h (2.84 kg/h)

The connected load is based on the following consumption calorific values:

Natural gas: 913 BTU/ft³ (34.02 MJ/m³) (Hi)

Liquid propane: 19,625 BTU/lb (45.65 MJ/kg) (Hi)

Natural gas

Natural gas	Length of gas line						
	9' 10" (3 m)	16' 4 7/8" (5 m)	32' 9 11/16" (10 m)	65' 7 3/8" (20 m)	98' 5 1/8" (30 m)	164' 1/2" (50 m)	328' 1" (100 m)
Internal diameter	Maximum flow rate						
3/4" (20 mm)	2.766 CFM (4.7 m ³ /h)	2.177 CFM (3.7 m ³ /h)	1.53 CFM (2.6 m ³ /h)	0.942 CFM (1.6 m ³ /h)	0.647 CFM (1.1 m ³ /h)	0.412 CFM (0.7 m ³ /h)	0.177 CFM (0.3 m ³ /h)
1" (25 mm)	5.061 CFM (8.6 m ³ /h)	4.061 CFM (6.9 m ³ /h)	2.825 CFM (4.8 m ³ /h)	1.824 CFM (3.1 m ³ /h)	1.412 CFM (2.4 m ³ /h)	1.118 CFM (1.9 m ³ /h)	0.53 CFM (0.9 m ³ /h)
1 1/4" (32 mm)	9.416 CFM (16.0 m ³ /h)	7.297 CFM (12.4 m ³ /h)	5.12 CFM (8.7 m ³ /h)	3.649 CFM (6.2 m ³ /h)	2.942 CFM (5.0 m ³ /h)	2.236 CFM (3.8 m ³ /h)	1.412 CFM (2.4 m ³ /h)
1 1/2" (40 mm)	15.595 CFM (26.5 m ³ /h)	12.064 CFM (20.5 m ³ /h)	8.533 CFM (14.5 m ³ /h)	6.062 CFM (10.3 m ³ /h)	4.943 CFM (8.4 m ³ /h)	3.825 CFM (6.5 m ³ /h)	2.354 CFM (4.0 m ³ /h)
2" (50 mm)	35.31 CFM (60.0 m ³ /h)	27.66 CFM (47.0 m ³ /h)	19.421 CFM (33.0 m ³ /h)	13.536 CFM (23.0 m ³ /h)	11.181 CFM (19.0 m ³ /h)	8.828 CFM (15.0 m ³ /h)	5.885 CFM (10.0 m ³ /h)

Installation

Liquid propane

Liquid propane	Length of gas line			
	16' 4 7/8" (5 m)	32' 9 11/16" (10 m)	65' 7 3/8" (20 m)	164' 1/2" (50 m)
Internal diameter	Maximum flow rate			
	3/8" (10 mm)	2.87 lb/h (1.3 kg/h)	2.2 lb/h (1.0 kg/h)	-
1/2" (12 mm)	4.41 lb/h (2.0 kg/h)	3.31 lb/h (1.5 kg/h)	2.2 lb/h (1.0 kg/h)	-
5/8" (16 mm)	8.82 lb/h (4.0 kg/h)	6.61 lb/h (3.0 kg/h)	4.41 lb/h (2.0 kg/h)	3.31 lb/h (1.5 kg/h)
7/8" (22 mm)	19.84 lb/h (9.0 kg/h)	14.33 lb/h (6.5 kg/h)	9.92 lb/h (4.5 kg/h)	6.61 lb/h (3.0 kg/h)
1 1/16" (27 mm)	-	26.46 lb/h (12.0 kg/h)	17.64 lb/h (8.0 kg/h)	11.02 lb/h (5.0 kg/h)

Exhaust gas evacuation ducts

Gas-heated Miele Tumble Dryers are type B₂₂ gas fuel-burning installations without flow safeguarding equipment, and with a fan behind the heater.

- The mixtures of exhaust gas and air that are emitted by gas-heated tumble dryers must be evacuated through a suitable chimney and out into the atmosphere via the roof.
- Exhaust air evacuation ducts and exhaust gas evacuation ducts must be kept as short as possible. The evacuation ducts must rise vertically up to the flue.
- Only materials that are resistant to heat and sooting may be used.
- A condensate drain must be placed at the lowest point of the exhaust ducting. The condensate must be drained via a water collection tray or a floor drain positioned in an appropriate location. No filters or grilles may be fitted in the pipeline. The exhaust air or exhaust gas ducting must be installed leak-tight.

Compliance with the latest guidelines for approving exhaust gas systems containing low-temperature exhaust gases must be assured.

Exceptions

1. Where it is not possible for evacuation to take place through a single duct, appropriate measures must be taken to ensure that the exhaust gas/air mixture from the machine is not able to enter the room in which the machine is located via the exhaust duct for other machines (e.g., through the use of baffles and merged lines that do not hinder the flow). When selecting and installing equipment that will not hinder the flow, it is important to ensure that high pressure cannot arise at the side that is not being operated. Machines fitted with fans must not be connected to the same vent flue as those without fans.
2. When evacuating the exhaust gas/air mixture through the exterior wall, no dangers or unreasonable nuisance may arise.
3. With a combined line, the exhaust air ducts for the individual machines must be installed horizontally in the combined line in a way that does not hinder the flow. The cross-section of the vent flue must not be smaller than the cross-section of the combined line. Combined lines must be kept as short as possible and must rise vertically up to the vent flue. A condensate drain is required at the lowest point.

All exceptional cases, and particularly those where a combined line is being installed, require special permission from the relevant building regulations inspector supervisor's office.

Diameter and cross-section of the exhaust ducting

Tumble dryers	Exhaust gas connection Diameter/cross-section
PDR 914/918/922/928/944/514/518/522/528/544	6"/27 1/4" (150 mm/176 cm ²)

2. What needs to be observed during commissioning

Check that the points listed in section 1 ("What needs to be observed before commissioning") have been taken into consideration. The following should be carried out in the given order when commissioning or converting the appliance:

1. Ask the gas supply company what the gas type, gas group, and connection pressure are, and compare this information with the data specified on the tumble dryer (see the sticker at the rear).
2. Check the factory-set jet pressure based on the tables "Settings with natural gas"/"Settings with liquid propane" and correct it if necessary.
3. If the gas type, gas group, or connection pressure is different, it must be converted as instructed in the section entitled "Connection and conversion instructions" and the sticker at the rear of the tumble dryer must be replaced accordingly.
4. If the gas type needs to be changed, please request the appropriate conversion kit from Miele Service. When doing so, please specify the product name and the appliance number, as well as the gas type, gas group, gas connection pressure, and country where the appliance has been set up.
5. Set the jet pressure at the tumble dryer's gas regulating valve (see tables "Settings with natural gas"/"Settings with liquid propane").
6. Switch on all gas consumers that are present (including the installed tumble dryer).
7. Measure the connection pressure. The connection pressure must be within the ranges specified in local guidelines.

Connection and conversion instructions

Connection and conversion work must be performed by Miele Service or by an authorized dealer.

The settings for tumble dryers are made at the factory in line with the gas specifications at the rear of the appliance.

Gas hose

The gas appliance must be connected using a corrugated metal hose assembly made from stainless steel in accordance with DIN 3384. Alternatively, a hose that complies with DIN EN 16617 may be used with connections in accordance with DIN 3384.

The maximum length of the hose is 6' 6" (2 m). When selecting a hose, the required flow rate and applicable national regulations must also be taken into account.

Installation

Main connection

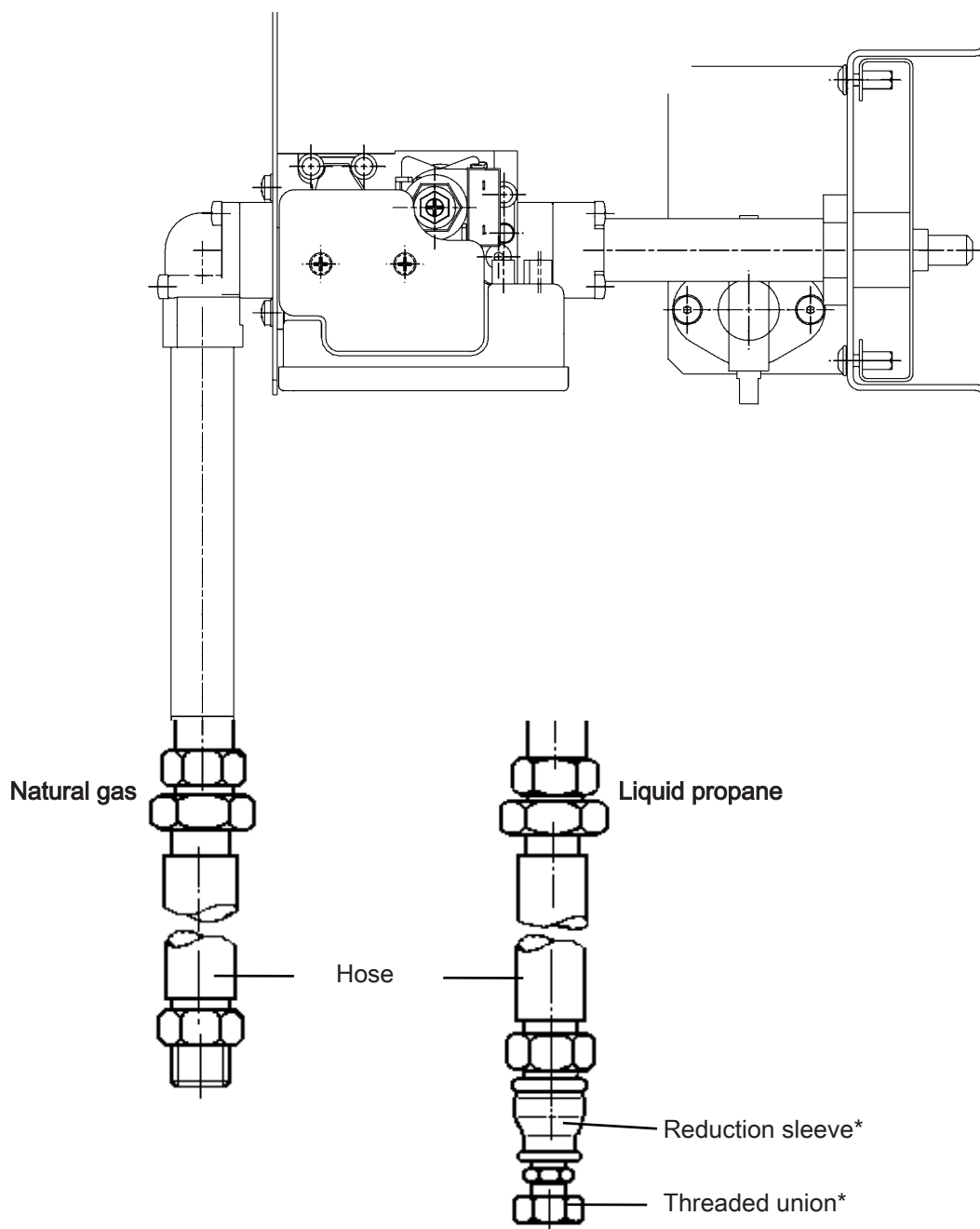

* Supplied with the kit for converting natural gas to propane (LP).

Gas regulator valve

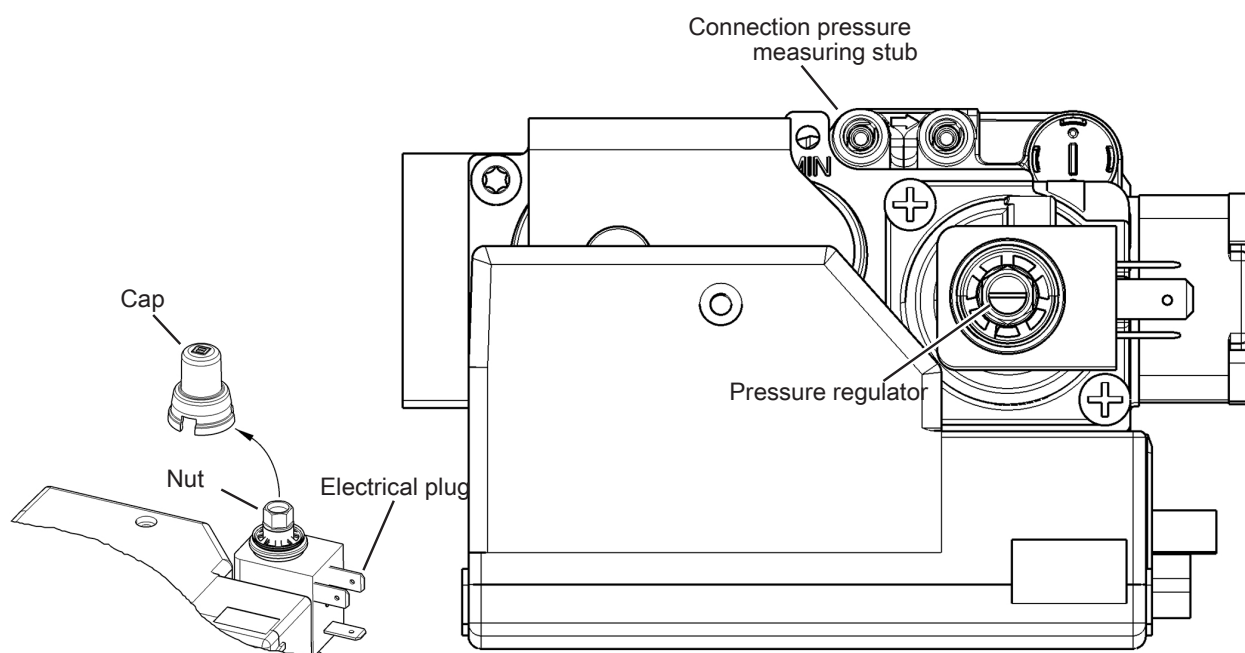

Jet pressure adjustment

Make sure that the maximum pressure is set first. Else the minimum pressure would be changed by turning the nut.

- Loosen the locking bolts of the connection pressure and jet pressure measuring stub.
- Check the connection pressure and jet pressure.
- Remove the cap from the pressure regulator.
- Fit a socket wrench or a ringspanner to the nut of the pressure regulator.

Setting maximum pressure at full heating

Values for natural gas: see table "Settings with natural gas"; values for liquid gas: see table "Settings with liquid propane"

- To increase or reduce the maximum jet pressure turn the nut in a clockwise or counterclockwise direction.

Adjusting the minimum pressure with power supply interrupted

- Pull out the plug. You need a slotted Screwdriver to adjust the minimum pressure.
- To increase or reduce the minimum jet pressure turn the slotted screw inside the nut in a clockwise or counterclockwise direction.

Make sure that the nut does not turn with it.

- Insert the plug again.
- Fit the cap onto the pressure regulator.
- Seal the connection pressure and jet pressure measuring stubs with the locking bolts.

Burner

PDR x14/x18/x22 = 1 jet; PDR x28/x44 = 2 jets

Installation

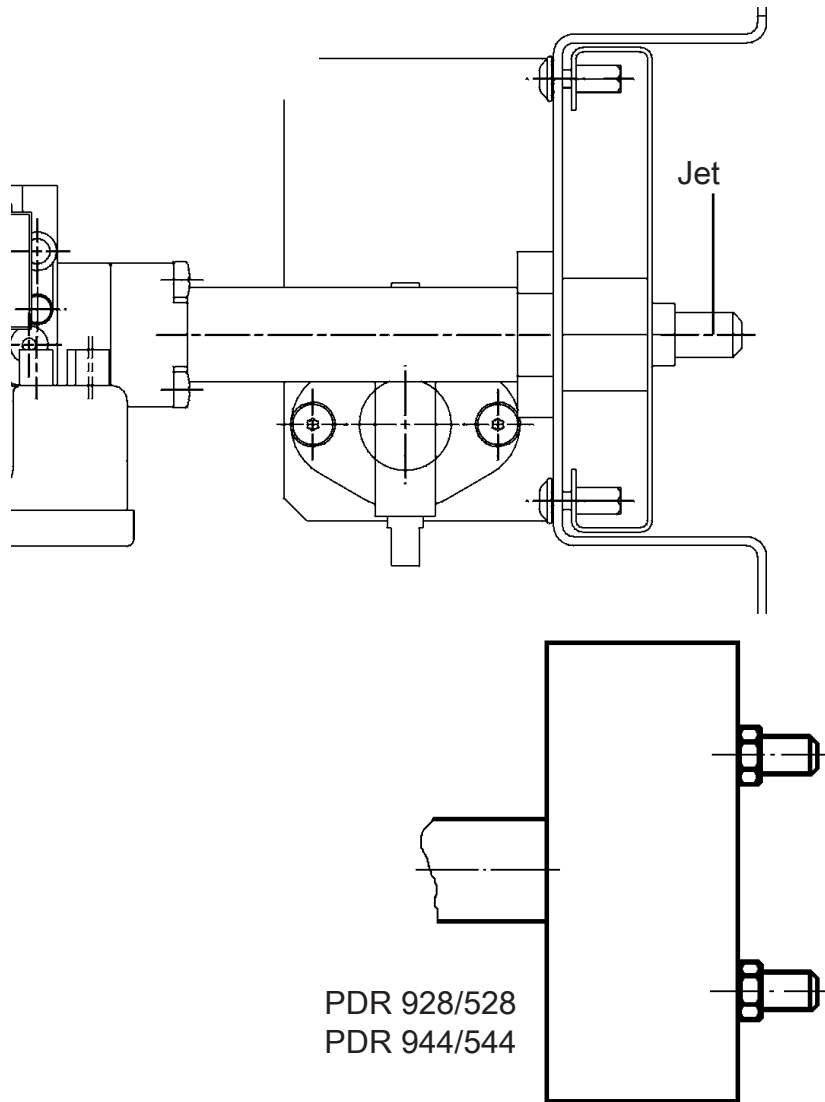

Burner conversion

- Replace the jet and the sealing ring (included with the conversion kit).
- Natural gas = large hole
- Liquid propane = small hole

Additional steps necessary to convert to liquid gas are outlined in the “Conversion kit for natural gas to liquid gas conversion”.

⚠ Gas lines and screw connections may leak after connection and conversion work. Gas may escape.

After connection and conversion work, the gas lines, all screw connections (including those on the jets), and the locking bolts on the measuring stubs must be checked to ensure they are leak-tight. This check must be performed both while the appliance is at a standstill and while it is in operation.

Settings with natural gas

Tumble dryers	Heater rating		Jet diameter	Jet pressure	
	Partial heating	Full heating		Partial heating	Full heating
PDR 914/514	9.2 kW	16.7 kW	1/8" (3.5 mm)	36 mpsi (2.5 mbar)	123 mpsi (8.5 mbar)
PDR 918/518	11.1 kW	20.0 kW	3/16" (4 mm)	33 mpsi (2.3 mbar)	102 mpsi (7.0 mbar)
PDR 922/522	14.4 kW	23.9 kW	3/16" (4.4 mm)	39 mpsi (2.7 mbar)	106 mpsi (7.3 mbar)
PDR 928/528	18.4 kW	33.3 kW	2 x 1/8" (2 x 3.5 mm)	36 mpsi (2.5 mbar)	123 mpsi (8.5 mbar)
PDR 944/544	22.2 kW	40.0 kW	2 x 3/16" (2 x 4 mm)	33 mpsi (2.3 mbar)	109 mpsi (7.5 mbar)

Settings with liquid propane

Tumble dryers	Heater rating		Jet diameter	Jet pressure	
	Partial heating	Full heating		Partial heating	Full heating
PDR 914/514	8.3 kW	15 kW	1/16" (2.05 mm)	145 mpsi (10 mbar)	0.39 psi (27 mbar)
PDR 918/518	10 kW	18 kW	1/16" (2.2 mm)	122 mpsi (8.4 mbar)	0.39 psi (27 mbar)
PDR 922/522	13 kW	21.5 kW	1/8" (2.4 mm)	145 mpsi (10 mbar)	0.39 psi (27 mbar)
PDR 928/528	16.6 kW	30 kW	2 x 1/16" (2 x 2.05 mm)	145 mpsi (10 mbar)	0.39 psi (27 mbar)
PDR 944/544	20 kW	36 kW	2 x 1/16" (2 x 2.2 mm)	122 mpsi (8.4 mbar)	0.39 psi (27 mbar)

Steam

The steam connection may only be carried out by a certified installer. In addition to these installation instructions, the information from the data plate, wiring diagram, and documentation accompanying the appliance must also be noted and complied with when connecting steam-heated Miele appliances.

Operating pressure values

High-pressure steam version, indirect	HP indir.	Minimum operating pressure	Maximum operating pressure
Tumble dryer		87 psi / 600 kPa / 6 bar	145 psi / 1,000 kPa / 10 bar
Tumble dryer TR		58 psi / 400 kPa / 4 bar	72 psi / 500 kPa / 5 bar

For efficiency, the operating pressures must not fall below the specified values.

 The appliances must not be connected to a hot oil circulation system.

Fitting information for steam and condensate hoses

- Ensure that the hoses are not twisted or compressed.
- Do not use steam and condensate hoses to compensate for gas lines.

Heater bank information

To avoid damage to the heater bank the following must be observed during commissioning:

Installation

- In order to avoid unnecessary heat variations, ensure that heating is even (do not allow sudden bursts of steam).
- In order to avoid corrosion, the feed water must be processed. In particular, when the appliance is not in operation, it is important to ensure that no air or CO₂ can enter the system. The condensate separator must be installed such that when the system is not operating, the heater bank is completely emptied. This means that no condensate may remain in the heater bank. The installation of an inverted bucket condensate trap is recommended.
- The heater bank must be protected from aggressive gases.
- The entire heating system must not operate at a higher pressure or temperature than specified on the data plate.
- All appropriate regulations, standards, and legislation from responsible authorities related to the installation and operation of heating and ventilation systems (in particular for the operation of the heat exchanger) must be observed.

Steam valve for high-pressure steam – indirect

Requirements profile:

- Pneumatic or servo-controlled
- Connection to ½" coupling
- Flow coefficient of at least 3 m³/h for water
- Media temperature at least 365°F (185°C)
- Operating voltage 230 V / 50 – 60 Hz
- Closed when de-energized
- Electrical connection for 1/4" (6 – 7 mm) cable diameter

⚠ Once the appliance has been connected, re-install all the housing parts that were removed.

Hot water

⚠ The hot water connection may only be carried out by an authorized or trained/certified technician.

In addition to these installation instructions, the information from the data plate, wiring diagram, and documentation accompanying the appliance must also be noted and complied with when connecting hot water-heated Miele appliances.

Operating conditions

Operating pressure	Feed water temperature	Peak capacity
87 - 145 psi / 600 – 1,000 kPa (6 – 10 bar)	158 – 203°F (70 – 95°C)	1.32 – 6.6 gal/min (0.3 – 1.5 m ³ /h)

For reasons of efficiency, the operating pressures must not fall below the specified values.

⚠ The appliances must not be connected to a hot oil circulation system.

Heater bank information

To avoid damage to the heater bank the following must be observed during commissioning:

- In order to avoid unnecessary heat variations, ensure that heating is even.
- In order to avoid corrosion, the feed water must be processed. In particular, when the appliance is not in operation, it must be ensured that no air or CO₂ can enter the system.
- The heater bank must be protected from aggressive gases.

- The entire heating system must guarantee that no operating pressure or temperature can arise that is higher than the details given on the data plate.
- The system must not be connected to the drinking water supply.
- All appropriate regulations, standards, and legislation from responsible authorities and accident prevention associations for heating and ventilation systems (in particular for the operation of the heat exchanger) must be observed.

⚠ Once the appliance has been connected, re-install all the housing parts that were removed.

⚠ Risk of electric shock and injury due to using the tumble dryer without the complete casing.

If the casing is dismantled, it is possible to come into contact with live or rotating machine parts.

Once the tumble dryer has been installed, completely replace all the casing parts that were removed.

Networking

Pairing instructions





Follow the steps below to connect the tumble dryer to your network.

Opening the Supervisor level

- Switch on the appliance by turning the rotary control from the  position to any other position.
- Open the door of the tumble dryer.
- Press and hold the start/stop sensor control while you close the door.
- Keep pressing the start/stop sensor control until start/stop flashes and then lights up permanently.

You are now in the Supervisor level.

Establishing the local network connection via WPS

- On the supervisor level, select *P91* using the < or > arrow buttons.
- Then select the internal communication module *-01* using the < or > arrow buttons.
- Confirm with the start/stop sensor control.
- Restart the tumble dryer by turning the rotary control to the  position.
- Switch the appliance on again by turning the rotary control from the  position to any other position.
- Press and hold the  sensor control for 4 seconds until *APP* appears on the display.
- Then press and hold the  sensor control for 2 seconds until *WPS* appears on the display.

A timer will then start.



- Press the WPS button on your router within the specified time.

The network connection via WPS is being established.

The appliance is now successfully connected.

Establishing a temporary network connection via soft AP

The network connection via soft AP is only possible if the tumble dryer is not already connected to a network.

- On the supervisor level, select *P91* using the < or > arrow buttons.
- Then select the internal communication module *-01* using the < or > arrow buttons.
- Confirm with the start/stop sensor control.
- Restart the tumble dryer by turning the rotary control to the  position.
- Switch the appliance on again by turning the rotary control from the  position to any other position.
- Press and hold the  sensor control until *APP* appears briefly on the display.

A timer will then start. The tumble dryer now opens the soft AP for 10 minutes.

- Establish the connection with the Device Connector in Miele MOVE.

Once a connection is established, dots flash in the *A.P.P* word.

Then continue with the Device Connector in Miele MOVE.

Establishing the network connection using a LAN cable

The optional XKM 3200 WL PLT communication module is required for wired network connection.

- On the supervisor level, select *P91* using the < or > arrow buttons.
- Then select the COM module -*02* using the < or > arrow buttons.
- Confirm with the start/stop sensor control.
- Connect the appliance to your router/switch using the network cable. The router/switch must be connected to the Internet.

The appliance is now successfully connected.

System requirements for WiFi

- WiFi 802.11b/g/n
- 2.4 GHz band
- WPA/WPA2 encryption
- DHCP activated
- MulticastDNS/Bonjour/IGMP snooping activated
- Ports 443, 80, 53, and 5353 open
- IP DNS server = IP standard gateway/router
- Mesh/repeater use: same SSID and password as standard gateway/router
- SSID must be permanently visible



System requirements for LAN

- DHCP activated
- MulticastDNS/Bonjour/IGMP snooping activated
- Ports 443, 80, 53, and 5353 open
- IP DNS server = IP standard gateway/router

WiFi signal strength – Guide values

The WiFi signal strength is only a rough guide. These details do not provide absolute certainty.

The WiFi signal strength can be read via the MDU or directly on the machine.

WiFi signal strength		Meaning
MDU		
76–100%	3/3**	Reliable operation possible
51–75%	2/3	
26–50%	1/3	Operation possible
1–25%	0/3	Reliable operation not possible
0%		Operation not possible

* Displayed on the machine

** Number of bars  3/3–0/3

The signal strength can be disturbed by many influences:

- people in the room
- open or closed doors
- moved objects

Networking

- varying radio signal sources or interference
- other machines with Bluetooth or WiFi wireless technology

► Only use genuine Miele spare parts and accessories with this machine. Using parts or accessories from other manufacturers will invalidate the warranty, and Miele cannot accept liability.

Cleaning set

The Miele Cleaning Set is available separately for effective and gentle cleaning of the tumble dryer.

The cleaning set consists of:

- microfiber cloth
- cleaning brush
- dust brush
- crevice nozzle

Communication box

The optional communication box allows external hardware from Miele and other suppliers to be connected to the Miele Professional machine. External hardware includes e.g., peak-load systems, pressure sensors, or an external vent flap.

The communication box is supplied with voltage by the Miele Professional machine.

The separately available set consists of the communication box and fasteners for installation on the machine or on the wall.

XKM 3200 WL PLT

The optional Miele communication module can be used to establish a data connection between a Miele Professional machine and a data processor in accordance with the Ethernet or WiFi standard.

This communication module fits into the communication slot which is a standard feature on all machines. The communication module offers the option of intelligent app-based communication with external systems. In addition, it can display detailed machine and program status information.

This module forms the basis for wired communication with Miele MOVE.

It is not possible to integrate the machine into the “Miele@home” app for domestic installations.

The communication module is intended exclusively for commercial use and is supplied with voltage directly via the Miele Professional machine. No additional power connection is required. The Ethernet interface provided via the communication module complies with SELV (safety extra low voltage) requirements in accordance with EN 60950. Connected external machines must also comply with SELV.

Data protection and data security

When you activate the networking function and connect your machine to the Internet, your machine sends the following data to the Miele Cloud:

- machine serial number
- machine model and technical features
- machine status
- information about the software status of your machine

Optional accessories

Initially, this data cannot be assigned to a specific user and is not saved permanently. Data cannot be saved permanently or assigned to a specific user until after you have linked your machine to a user. Data transmission and processing are governed by Miele's strict security standards.

Factory default settings for network configuration

You can reset all of the settings on the communication module or your integrated WiFi module to the factory default settings. The network configuration should be reset whenever a machine is being disposed of or sold, or if a used machine is being put into operation. This is the only way to ensure that all personal data has been removed and the previous owner will no longer be able to access the machine.

Copyrights and licenses

For the purpose of operating and controlling the communication module, Miele uses proprietary or third-party software that is not covered by open source licensing terms. This software/these software components are protected by copyright. The copyrights held by Miele and third parties must be respected.

This communication module contains software components which are distributed under open source license conditions. The open source components contained in the machine along with the corresponding copyright notices, copies of the licensing terms valid at the time, and any additional information can be accessed locally by IP via a web browser (<https://<IP address>/Licenses>). The liability and warranty arrangements for the open source licenses displayed in this location only apply in relation to the respective rights holders.

Original spare parts and accessories

Miele machines are highly durable due to their excellent quality. If, however, repair work does become necessary, key functional spare parts will remain available for up to 15 years following discontinuation (this does not apply to digital products or products for process documentation).

Contact Miele Customer Service if you need spare parts and accessories or would like personalized advice.

 Danger due to improperly performed service and repair work.

Service and repair work should only be carried out by a suitably qualified electrician in accordance with all appropriate safety requirements.

Servicing, modification, testing, and maintenance of electrical machines must be carried out in accordance with all appropriate legal requirements, accident prevention regulations, and valid standards.

All live wires must be safely disconnected before any service or repair work is commenced on the machine.

Technical data

	PDR 514	PDR 518	PDR 522	PDR 528	PDR 544
Height	55 1/8" (1,400 mm)	55 1/8" (1,400 mm)	55 1/8" (1,400 mm)	64 9/16" (1,640 mm)	64 9/16" (1,640 mm)
Width	35 11/16" (906 mm)	35 11/16" (906 mm)	35 11/16" (906 mm)	47 1/2" (1,206 mm)	47 1/2" (1,206 mm)
Depth	33 9/16" (852 mm)	40 3/4" (1,035 mm)	45 3/4" (1,162 mm)	40 1/8" (1,019 mm)	54 1/2" (1,385 mm)
Depth with door open	57 5/16" (1,456 mm)	64 1/2" (1,639 mm)	69 5/8" (1,768 mm)	63 7/8" (1,623 mm)	78 5/16" (1,989 mm)
Drum volume	66 gal (250 l)	86 gal (325 l)	106 gal (400 l)	132 gal (500 l)	211 gal (800 l)
Maximum load size (dry weight)	30 lbs (13.5 kg)	40 lbs (18 kg)	50 lbs (22.5 kg)	60 lbs (27 kg)	100 lbs (45 kg)
Connection voltage					See data plate
Fuse rating (on site)					See data plate
Power rating					See data plate
Test certificates awarded					See data plate
Product safety standard					IEC 60335-1; IEC 60335-2-11; UL 1240
Sound pressure level, ISO 11204					<70 dB (A)
Sound power level, ISO 9614-2					<80 dB (A)
Frequency range					2.4000–2.4835 GHz
Maximum transmission power					< 100 mW

ANY CHANGES OR MODIFICATIONS NOT EXPRESSLY APPROVED BY THE PARTY RESPONSIBLE FOR COMPLIANCE COULD VOID THE USER'S AUTHORITY TO OPERATE THE EQUIPMENT.

THIS DEVICE COMPLIES WITH PART 15 OF THE FCC RULES AND CONTAINS LICENSE-EXEMPT TRANSMITTER(S)/RECEIVER(S) THAT COMPLY WITH INNOVATION, SCIENCE AND ECONOMIC DEVELOPMENT CANADA'S LICENCE-EXEMPT RSS STANDARD(S). OPERATION IS SUBJECT TO THE FOLLOWING TWO CONDITIONS: (1) THIS DEVICE MAY NOT CAUSE HARMFUL INTERFERENCE, AND (2) THIS DEVICE MUST ACCEPT ANY INTERFERENCE RECEIVED, INCLUDING INTERFERENCE THAT MAY CAUSE UNDESIRE OPERATION.

Contains FCC ID: 2ACUWEK047

Contains IC: 5669C-EK047

RADIATION EXPOSURE STATEMENT: THIS EQUIPMENT COMPLIES WITH FCC AND WITH ICSED RADIATION EXPOSURE LIMITS SET FORTH FOR AN UNCONTROLLED ENVIRONMENT. THIS EQUIPMENT SHOULD BE INSTALLED AND OPERATED WITH A MINIMUM DISTANCE OF 20CM BETWEEN THE RADIATOR AND YOUR BODY. THIS DEVICE AND ITS ANTENNA(S) MUST NOT BE CO-LOCATED OR OPERATION IN CONJUNCTION WITH ANY OTHER ANTENNA OR TRANSMITTER.

Please have the model and serial number of your machine available when contacting Technical Service.

Veuillez indiquer le modèle et le numéro de série de votre appareil lorsque vous contactez le service à la clientèle.

U.S.A.
Miele, Inc.

National Headquarters

9 Independence Way
Princeton, NJ 08540
Phone: 800-991-9380
www.mieleusa.com/professional
prosales@mieleusa.com

Technical Service & Support

Phone: 800-991-9380
proservice@mieleusa.com

Canada
Importer | Importateur
Miele Limited | limitée

Professional Division

161 Four Valley Drive
Vaughan, ON L4K 4V8
Phone | Tél. : 1-888-325-3957
www.mieleprofessional.ca
professional@miele.ca

Miele Professional Technical Service | Service Technique

Phone | Tél. : 1-888-325-3957
serviceprofessional@miele.ca



Manufacturer | Fabricant : Miele & Cie. KG
Carl-Miele-Straße 29, 33332 Gütersloh, Germany | Allemagne