

## Operating instructions Commercial dishwasher PFD 401 Marine





To avoid the risk of accidents or damage to the appliance, it is **essential** to read these instructions before it is installed and used for the first time.

en-GB

# Contents

---

<b>Notes about these instructions</b> .....	6
Symbols used on the commercial dishwasher.....	7
Definition of terms .....	7
<b>Correct use</b> .....	8
<b>Guide to the appliance</b> .....	9
Machine overview.....	9
Control panel.....	10
LEDs in buttons.....	11
<b>Warning and Safety instructions</b> .....	12
Warning signs and symbols attached to the dishwasher.....	15
Disposal of your dishwasher .....	15
<b>Caring for the environment</b> .....	16
<b>User profiles</b> .....	17
User groups.....	17
<b>User tips</b> .....	18
Switching on.....	18
Switching off.....	19
Standby/Off .....	19
Display screens .....	19
Touch display .....	19
Status window.....	20
Fault messages  .....	20
<b>Commissioning</b> .....	21
Installation and connection .....	21
Procedure .....	21
Switching on.....	21
Selecting a language .....	21
WiFi setup.....	21
Setting the temperature units.....	21
Setting the date.....	22
Setting the time of day .....	22
Setting the water hardness .....	22
Selecting water connections.....	23
Commissioning completed .....	23
<b>Opening and closing the door</b> .....	24
Comfort door lock .....	24
Open the door .....	24
Closing the door.....	24
Opening the door using the emergency release .....	25
<b>Filling the container for dishwasher salt</b> .....	26
Water hardness .....	26
Setting the water hardness .....	26
Setting the water hardness .....	26
Salt refill indicator.....	28
Reactivation notification.....	28
Machine blocked if salt is not available.....	28

<b>Loading the dishwasher</b> .....	30
Loading the dishwasher .....	30
We recommend .....	31
Upper basket.....	32
Adjusting the upper basket .....	33
Lower basket.....	34
Loading plastic trays .....	35
<b>Cleaning agent and rinsing agent</b> .....	36
Dispensing systems .....	36
Dispensing module.....	36
Cleaning agent .....	37
Replacing the canister.....	37
Refill indicator.....	38
Dispensing liquid cleaning agent .....	38
Filling the door dispenser.....	38
Tips for the Super Short programme (depending on the model) .....	39
Rinsing agent.....	40
Replacing the canister.....	40
Refill indicator.....	41
Filling the door dispenser .....	41
Refill indicator.....	42
Dispensing rinsing agent .....	42
<b>Operation</b> .....	43
Switching on.....	43
Selecting a programme .....	43
Starting a programme .....	44
Starting the programme using a timer.....	44
Programme sequence display .....	45
End of a programme.....	46
Switching off.....	46
Unloading the crockery .....	46
Interrupting a programme.....	46
Cancelling a programme .....	47
 <b>Machine functions</b> .....	48
Menu structure .....	48
Dispensing paths.....	48
Filling dispensing paths.....	48
Rinsing dispensing paths .....	49
 <b>Settings</b> .....	51
Menu structure .....	51
Time of day.....	52
Date .....	53
Display brightness .....	54
Volume.....	54
Button reaction.....	55
Welcome tone .....	55
Temperature unit.....	56

# Contents

---

 <b>Further settings</b> .....	57
Menu structure .....	57
Filter programme lock .....	59
Standby/Off .....	59
Log book .....	60
Release programme .....	61
Set favourites .....	61
Start screen layout .....	61
Setting favourites .....	62
Programme parameters.....	62
Selecting a programme .....	62
Main wash temperature.....	63
Main wash holding time .....	63
Final rinse temperature.....	63
Final rinse holding time .....	63
Increased water level.....	64
Interim rinse.....	64
Resetting parameters .....	64
Dispensing systems .....	65
Selecting a dispensing system.....	65
Door dispenser .....	65
Activating dispensing from the canister .....	66
Deactivating dispensing from the canister .....	67
Dispensing concentration.....	67
Filling dispensing paths.....	67
Rinsing dispensing paths .....	67
Cycles until empty.....	68
Water hardness .....	68
Reactivation notification.....	68
Memory .....	69
PIN code.....	69
Entering the PIN code .....	69
Blocking further settings or making them available .....	70
Changing a PIN code .....	70
Networking/WiFi .....	71
WiFi setup.....	71
Connection via WPS .....	71
Soft AP .....	72
Connecting via Soft-AP .....	72
RemoteUpdate .....	73
Showroom programme.....	73
Software version.....	73
Factory defaults.....	74
Legal information.....	74
<b>Cleaning and care</b> .....	75
Periodic checks .....	75
Cleaning the control panel .....	75
Cleaning the machine front .....	76
Cleaning the wash cabinet.....	76
Cleaning the door and the door seal.....	76
Cleaning filters in the wash cabinet.....	77

---

<b>Problem solving guide</b> .....	79
Technical problems .....	79
Faults with water inlet or drainage.....	80
Cancel with fault number .....	81
Door.....	83
General problems with the dishwasher .....	84
Noises.....	86
Unsatisfactory washing result .....	87
<b>Maintenance</b> .....	89
Cleaning the water inlet filter.....	89
Cleaning the drain pump and non-return valve.....	90
<b>Customer service</b> .....	91
<b>Programme chart</b> .....	92
<b>Installation</b> .....	94
Installation .....	94
Built-under installation .....	94
Hose holder .....	94
Adjustable plinth panel (depending on the model).....	95
Levelling and securing the dishwasher .....	96
Floor anchoring .....	96
Moving the dishwasher .....	97
<b>Electrical connection</b> .....	98
Peak-load negotiation .....	98
<b>Plumbing</b> .....	99
Connecting the water inlet .....	99
Connecting the drain hose .....	100
<b>Technical data</b> .....	101

## Notes about these instructions

---

### Warnings

 Warnings contain information which is important for safety. They alert you to the potential danger of injury to people or damage to property. Read these warning notes carefully and observe the procedural instructions and codes of practice they describe.

### Notes

Notes provide information of particular importance that must be observed.

### Additional information and comments

Additional information and comments are contained in a box with a simple frame.

### Operating steps

Instructions on operation are identified by specially marked procedural instructions. They explain the procedure step by step. Operating steps are indicated by a black square bullet point.

#### Example:

- Open the door.





### Display

Information that is shown on the commercial dishwasher display appears in a special font similar to the display text.

#### Example:

Select  Settings and confirm your choice with the *OK* button.

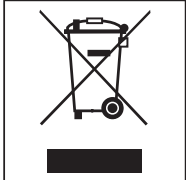
### Symbols used on the commercial dishwasher

Symbol	Key
	For warnings, see “Warnings and safety notes”
	VDE symbol
	EMC symbol of the VDE
	Do not dispose of electrical machines in household waste; they need to be disposed of separately, see “Disposal of your old machine”
	CE marking of the EU The corresponding declaration of conformity is enclosed with the machine and can be obtained from the manufacturer.
	Manufacturer

### Definition of terms

#### Dishwashers

The commercial dishwasher is referred to as a dishwasher in these operating instructions.

#### Load items

The term “load items” is used wherever the items to be processed are not defined in any further detail.

#### Wash water

The term “wash water” is used for the mixture of water and process chemicals.

#### Process chemicals

All media dispensed during a programme sequence are generally referred to as process chemicals, e.g. cleaning agents.

#### Cycle

Machine-based cleaning and reprocessing procedures are generally referred to as cycles.

## Correct use

---

- ▶ This Miele commercial dishwasher with its short programme running times and powerful cleaning performance is intended for commercial use. The commercial dishwasher can also be used on ships with a hull of longer than 24 metres, as well as on oil rigs.
- ▶ The commercial dishwasher is subsequently referred to as a dishwasher in these operating instructions. The washable items in commercial dishwashers, such as plates, cups, glasses and cutlery, are generally referred to in these operating instructions as load items when they are not defined in more detail.
- ▶ This appliance is designed exclusively for use as a “dishwasher” for cleaning loads as described in these instructions. Conversions, modifications and any other use are not permitted.
- ▶ This dishwasher is intended for stationary, indoor use only.
- ▶ The special inserts in the baskets should only be used for their specific application.
- ▶ This dishwasher may not be used to clean medical products or devices.
- ▶ This dishwasher can only be used by people with reduced physical, sensory or mental capabilities, or lack of experience or knowledge, if they are supervised whilst using it or have been shown how to use it in a safe way and understand and recognise the consequences of incorrect operation.
- ▶ The commercial dishwasher should only be used in calmer waters (ports and harbours).
- ▶ This commercial dishwasher can only be used on a ship if:
  - The ship’s hull is longer than 24 metres.
  - The list of the vessel is not more than 2°.
  - Any external vibration is no more than 150 Hz at an amplitude of 0.35 mm.

The safe operation and correct functioning of the commercial dishwasher can only be guaranteed if the above conditions are met.

- ▶ The door of the commercial dishwasher must not be opened during operation.
- ▶ Inappropriate use can lead to water leakage.
- ▶ This dishwasher must only be operated by appropriately trained personnel. They must be instructed and trained regularly.
- ▶ The commercial dishwasher may not be operated on an open deck.
- ▶ Children should be supervised in the vicinity of the dishwasher. Never allow children to play with the appliance. There is a danger that children might shut themselves in the dishwasher.
- ▶ Children must not use the dishwasher.



## Machine overview

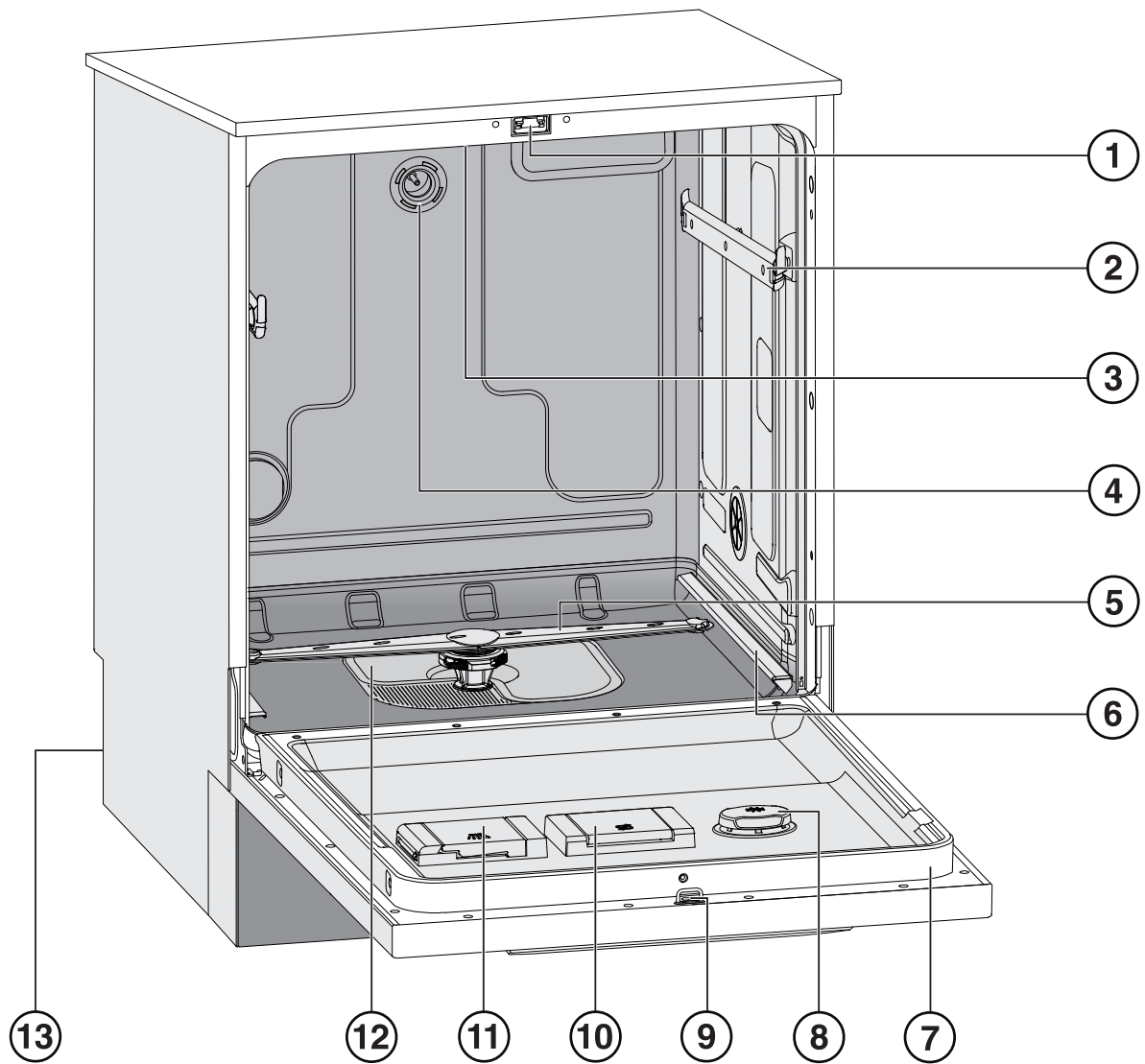



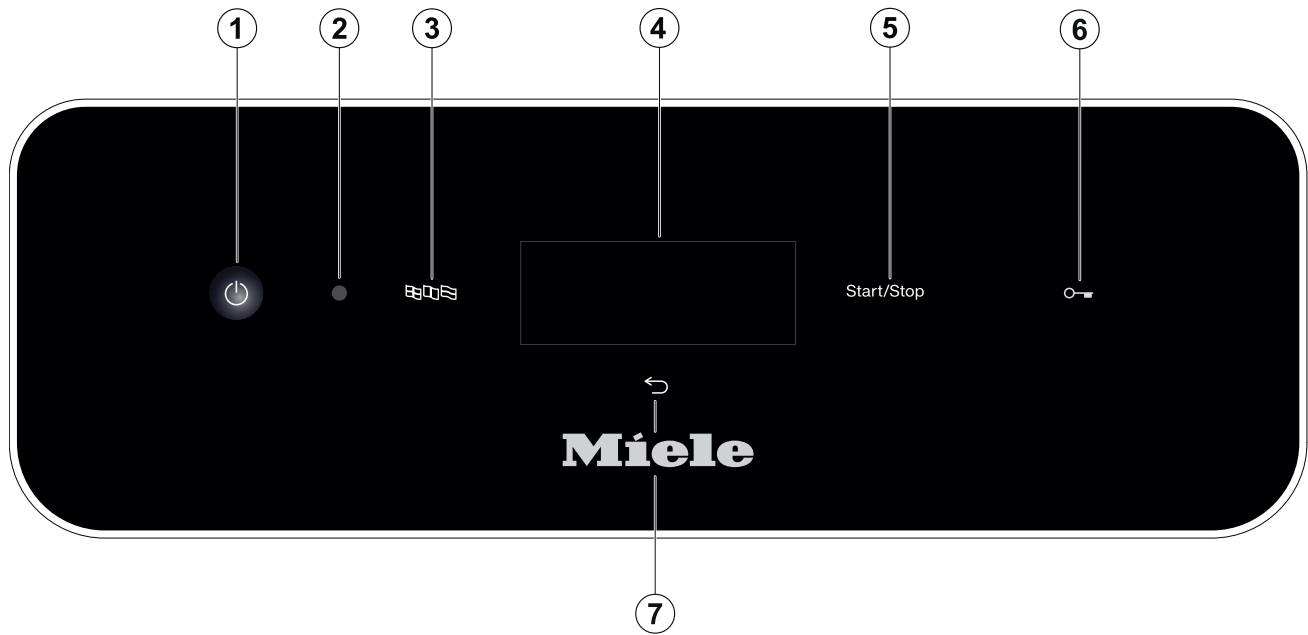

- |                                 |   |
|---------------------------------|---|
| ① Door lock                     | ⑧ Rinsing agent container   |
| ② Upper basket runners          | ⑨ Door lock latch   |
| ③ Top machine spray arm         | ⑩ Salt container  |
| ④ Upper basket water connection | ⑪ Container for powder cleaning agents                              |
| ⑤ Lower machine spray arm       | ⑫ Filter combination  |
| ⑥ Lower basket runners          | ⑬ Rear:   |
| ⑦ Data plate                    | – Electrical and water connections                                  |
|                                 | – Suction lance(s) for external containers (depending on the model) |
|                                 | – Connections for external dispensing modules (DOS modules)         |

# Guide to the appliance

## Control panel



- ①  button (On/Off)  
For switching the dishwasher on and off
- ② Service interface  
Testing and transmission point for the Miele Customer Service Department
- ③  button (language selection)  
For selecting the display language
- ④ Touch display  
For displaying and selecting control elements
- ⑤ *Start/Stop* button  
For starting or cancelling a programme
- ⑥  button (door release)  
Open the door
- ⑦  button (cancel or back)  
For cancelling a process in the user interface (not for cancelling programmes)

### LEDs in buttons

Light-emitting diodes are incorporated in the buttons. They indicate the status of the dishwasher.

Button	LED	Display	Status
Display (Reaction to ⏻ On/ ⏻ Off button)		<b>ON</b>	The dishwasher is switched on.
		<b>OFF</b>	The dishwasher is switched off.
<i>Start/Stop</i> button	<b>Pulsing</b>	<b>OFF</b>	The dishwasher is in standby mode.
		<b>ON</b>	A programme has been selected but not yet started.
		<b>ON</b>	A message has appeared on the display.
	<b>Flashes red</b>		A fault has occurred (see the fault message on the display and the “Problem solving guide”).
	<b>ON</b>		A programme is running.
	<b>OFF</b>		A programme has finished.
⏻ button (door button)	<b>ON</b>		A programme has been selected but not yet started.
			A programme is running.
			A programme is finished and the door is closed.

## Warning and Safety instructions

---

### Correct installation

- ▶ This dishwasher may only be installed and assembled on ships with a hull longer than 24 metres by qualified persons who will ensure that the requirements for the safe installation of this dishwasher are met.
- ▶ When installing the dishwasher, it must be securely fixed to the floor. Failure to do this could result in personal injury, damage to the dishwasher and damage to other objects and installations.
- ▶ This dishwasher must be securely bolted to the floor using the floor anchoring kit included.
- ▶ Do not install this dishwasher in an area where there is a risk of explosion or freezing conditions.
- ▶ To ensure stability a built-under dishwasher must only be installed beneath a continuous worktop that is bolted to the adjacent cabinetry.
- ▶ In order to reduce the risk of damage from condensation, the furniture in the area around the dishwasher should ideally be designed for commercial use. Furniture can be protected using the vapour protection set, which is available as an optional accessory. The vapour barrier film should be stuck under the worktop in the area around the dishwasher door.

### Technical safety

- ▶ This dishwasher must only be commissioned, repaired and maintained by the Miele Customer Service Department, a dealer or a suitably qualified service technician. Unauthorised installation, maintenance and repairs can cause considerable danger for the user.
- ▶ Before using the dishwasher, check it for any externally visible damage. Do not use a damaged dishwasher. This could be dangerous.
- ▶ In the event of a damaged or leaking dishwasher, switch off at the power supply immediately and call the Miele Customer Service Department, a Miele dealer or a suitably qualified service technician.
- ▶ Faulty components must only be replaced by genuine Miele original spare parts. Only when these parts are fitted can Miele guarantee the correct functioning and safety of the appliance.
- ▶ The electrical safety of this dishwasher can only be guaranteed when correctly earthed. If in any doubt, please have the electrical installation tested by a qualified electrician.
- ▶ Please follow the advice on installation in these operating instructions and the installation plan.
- ▶ Before connecting the appliance, ensure that the connection data on the data plate (voltage, frequency and fuse rating) match the mains electrical supply.
- ▶ There must be no electrical sockets behind the dishwasher. Danger of overheating and fire risk if the dishwasher were to be pushed up against a plug. See “Electrical connection”.

## Warning and Safety instructions

---

- ▶ Do not connect the dishwasher to the mains electricity supply via a multi-socket unit or an extension lead. These do not guarantee the required safety of the appliance (e.g. danger of overheating).
- ▶ Never open the casing of the dishwasher. Any contact with live connections or tampering with the electrical or mechanical components of the dishwasher will endanger your safety and may lead to appliance malfunctions.
- ▶ The dishwasher must not be used if the electrical connection cable is damaged. A damaged connection cable may only be replaced by a suitable connection cable of the same type. For safety reasons, such replacement may only be carried out by the Miele Customer Service Department or a qualified service technician.
- ▶ The dishwasher must be disconnected from the mains electricity supply before any maintenance or repair work is carried out.
- ▶ The plastic housing of the water connection contains electrical components. It must not be dipped in water.
- ▶ There are electrical wires in the water inlet hose. Do not shorten the water inlet hose, even if it is too long.

### Correct use

- ▶ This dishwasher is designed for operation with water and detergents suitable for use in commercial dishwashers only. Organic solvents and flammable liquid agents must not be used in it.  
This could cause an explosion, damage rubber or plastic components in the dishwasher and cause liquids to leak out of it.
- ▶ Only use detergents formulated for use in commercial dishwashers. Unsuitable detergents could adversely affect components of the dishwasher or the load items.
- ▶ Do not sit, stand or lean on the opened door. This would tip or damage the dishwasher.
- ▶ After any plumbing work the water pipework to the dishwasher will need to be vented. If this is not done, components can be damaged.
- ▶ Please be aware that the dishwasher may be operating at high temperatures. When the door is opened there is a danger of burning or scalding. Items, baskets and inserts must be allowed to cool down before they are unloaded. Any water remaining in containers could still be very hot. Empty them into the wash chamber before taking them out.
- ▶ The water in the cabinet must not be used as drinking water.
- ▶ Pre-treating items (for example with washing-up liquid and other cleaning agents) as well as some types of soiling and some cleaning agents can cause a build-up of foam in the wash cabinet. Foam can have an adverse effect on the cleaning result.
- ▶ Foam escaping from the wash cabinet can cause damage to the dishwasher. If foam escapes the programme must be cancelled immediately and the appliance must be disconnected from the mains electrical supply.
- ▶ There may be a risk of slipping if liquid is spilt on the floor depending on the type of flooring and footwear being worn. Keep the floor dry where possible and take care to clean up any liquid spills straight away. Take the necessary precautions when cleaning up hazardous substances and hot liquids.

## Warning and Safety instructions

---

- ▶ When using cleaning agents and specialised products, it is essential that the manufacturer's instructions are followed. Cleaning agents must only be used for the purpose they are designed for by the manufacturer to avoid any material damage or the occurrence of strong chemical reactions (e.g. oxyhydrogen explosion).
- ▶ To avoid material damage and corrosion, do not allow any acids or solutions containing chloride to get into the wash cabinet or onto the casing. Similarly avoid any ferrous materials with a corrosive effect.
- ▶ Do not wash items soiled with ash, sand, wax, lubricating grease or paint in the dishwasher. These materials will cause damage to the dishwasher.
- ▶ Do not clean the dishwasher or near vicinity with a hose or a pressure washer.
- ▶ Ensure that the outer casing of the machine does not come into contact with solutions or steam containing acid to avoid any corrosion damage.
- ▶ Be careful when sorting items with sharp pointed ends and positioning them in the dishwasher that you do not hurt yourself or create a danger for others. Sharp knives, forks, etc. should be placed in baskets with the pointed ends facing downwards.
- ▶ The grille of dishwashers with active drying must not be blocked or sealed.

### Accessories

- ▶ Only use genuine Miele original spare parts and accessories with this dishwasher. Using spare parts or accessories from other manufacturers will invalidate the guarantee and Miele cannot accept liability.
- ▶ Only use Miele baskets and inserts with this dishwasher. Using baskets and inserts made by other manufacturers, or making modifications to Miele accessories can cause unsatisfactory cleaning results, for which Miele cannot be held liable. Any resultant damage would not be covered by the guarantee.

## Warning and Safety instructions

### Warning signs and symbols attached to the dishwasher

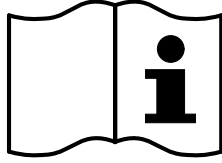

Warning:  
Observe the operating instructions!

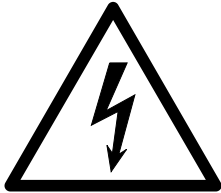

Warning:  
Danger of electric shock!



Warning: Hot surfaces:  
It can be very hot inside the wash cabinet when the door is opened!



Risk of being cut:  
Wear cut-resistant protective gloves when transporting and setting up the machine!

### Disposal of your dishwasher

- ▶ For safety and environmental reasons, dispose of all chemical agents according to the manufacturer's instructions and to safety regulations. Safety goggles and protective gloves should be worn.
- ▶ Render the door lock inoperable to prevent children from accidentally locking themselves inside the machine. Ensure a safe removal and proper disposal of the dishwasher (see "Caring for the environment").

## Caring for the environment

---

### Disposing of the packaging material

The packaging material is used for handling and protects the appliance from transport damage. The packaging material used is selected from materials which are environmentally friendly for disposal and can generally be recycled.

Recycling the packaging material reduces the use of raw materials. Use material-specific collection points for valuable materials and take advantage of return options. Your Miele dealer will take the packaging material away.

### Disposing of your old appliance

Electrical and electronic appliances contain many valuable materials. They also contain certain materials, compounds and components which were essential for their correct functioning and safety. These could be hazardous to human health and to the environment if disposed of with household waste or if handled incorrectly. Please do not, therefore, dispose of your old appliance with household waste.



Instead, please make use of officially designated collection and disposal points to dispose of and recycle electrical and electronic appliances in your local community, with your dealer or with Miele, free of charge. By law, you are solely responsible for deleting any personal data from the old appliance prior to disposal. You are legally obliged to remove any old batteries which are not securely enclosed by the appliance and to remove any lamps without destroying them, where this is possible. These must be taken to a suitable collection point where they can be handed in free of charge. Please ensure that your old appliance poses no risk to children while being stored for disposal.



### User groups

Users can be divided into two groups:

- **Daily operators**

Daily operators must be instructed on operating and loading the dishwasher and trained regularly to guarantee safe daily use.

- **Experienced operators**

Experienced operators can additionally block access to programmes and modify programme parameters. These functions are stored in a PIN code-protected area of the control unit.

## User tips



### Operation

Operation is carried out via the touch display as well as via the buttons on the control panel.

The sensor controls on the control panel and the buttons on the display react to finger tip contact. Every touch on the sensor controls is confirmed by a keypad tone. You can adjust the volume of the keypad tone or switch it off (see “Settings/Volume”).

The control panel with sensor controls and the touch display can be scratched by pointed or sharp objects, e.g. pens. Only touch the control field with your fingers.

### Switching on

The dishwasher needs to be connected to the electricity supply.

- Press and hold the  button until the following appears on the display:



As soon as the dishwasher is ready for operation, the display message changes to show the programme selection screen, e.g.:

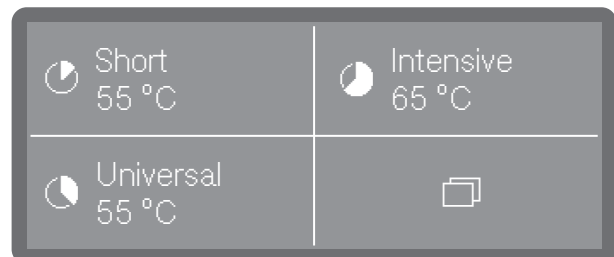

If the Memory function is activated, the most recently started programme is displayed, e.g.:

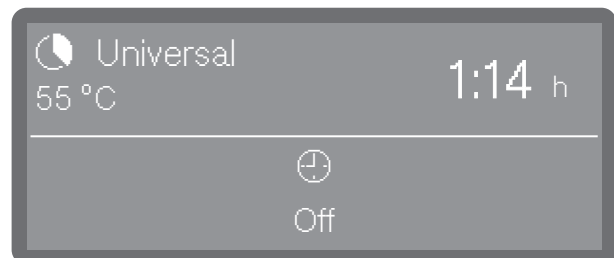

## Switching off

- Press the  button.

The dishwasher remains in standby mode for about one minute before it switches off completely.

## Standby/Off

If the dishwasher has not been used for 10 minutes, it can be set to standby or switched off automatically.

In standby mode, the dishwasher remains switched on and the *Start/Stop* button flashes. The dishwasher can be reactivated by pressing the *Start/Stop* button, touching the display or opening the door.

After automatic switch-off, the dishwasher is switched off and can be switched on again by pressing the  button.

## Display screens



All display screens shown in these operating instructions are examples, which can be different from the actual display screens.

## Touch display

In operating mode, the display is divided into 2–4 fields. The fields are buttons that can be selected by tapping on them.

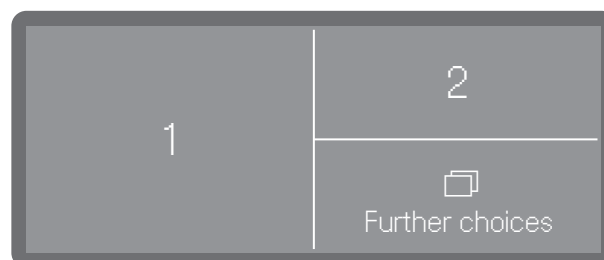

Fields 1–3 are assigned pre-selected programmes ex-works. However, you can also assign favourite programmes to these fields.  (Further choices) opens the system settings.

## User tips

The displays for the system settings and for system and fault messages are divided into 3 columns.

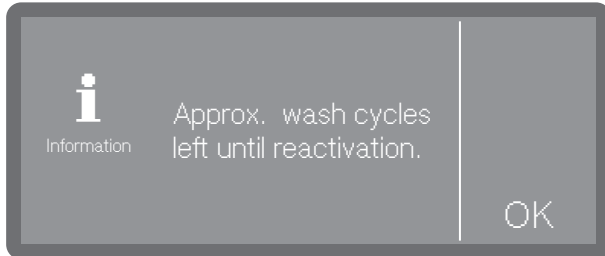
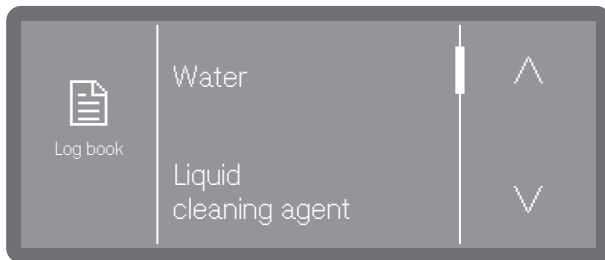

The left-hand column displays the title of the currently selected menu with a pictogram or, in the case of system or fault messages, the pictograms for information **i** or faults **!**.

The central column contains the menu options that can be selected and the system or fault messages.

If required for the specific context, control elements are displayed in the right-hand column, such as the **^** and **v** arrow buttons or an **OK** button.

### Status window

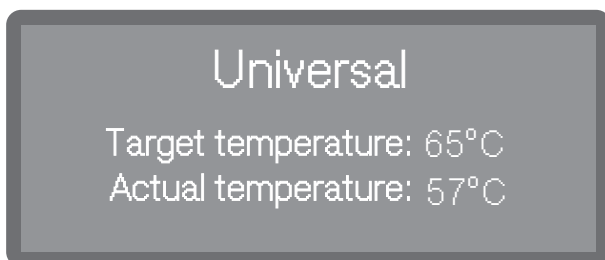

A symbol **i** appears on the display while a programme is running. If you tap this symbol, a status window opens for 10 seconds, which you can use to display various parameters and status messages about the programme in progress.

### System messages **i**

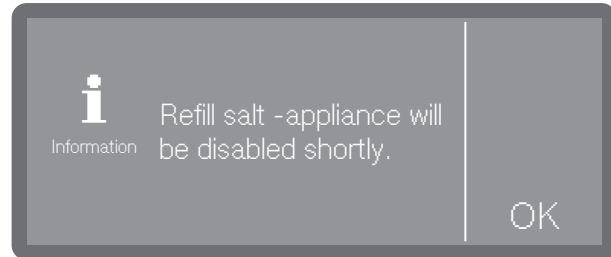

The **i** symbol denotes system messages. These give information about current processes and the status of the machine. System messages are displayed at the end of the programme. If there is more than one system message, they are shown one after the other and must be acknowledged individually by pressing **OK**.

### Fault messages **!**



In the event of a fault, a warning symbol **!** appears on the display and the *Start/Stop* button flashes red in rapid succession. If buzzer tones are activated, a warning tone will also sound.



- Acknowledge the fault by tapping on the warning symbol. Then follow the instructions on the display and in the “Problem solving guide”.

## Installation and connection

Before commissioning, the dishwasher must be securely installed, and the water inlet and drain hoses and the mains cable correctly connected. Follow the instructions in “Installation”, “Water connection” and “Electrical connection” as well as the installation plan.

## Procedure

The commissioning process follows a set procedure which cannot be interrupted.

All settings, except for water connections, can be retrospectively altered via the  Machine functions,  Settings and  Extended settings menus.

## Switching on

- Press the  button.

## Selecting a language

Commissioning starts with the selection of the display language.



- Scroll to the language you want using the  $\wedge$  and  $\vee$  arrow buttons and select the language by tapping on it.

## WiFi setup

In the next step, you can connect your dishwasher to the WiFi network.

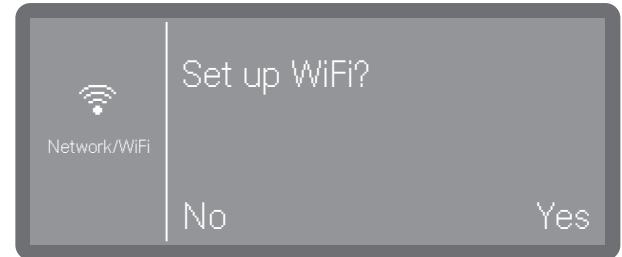

- Select No if you do not want to integrate the dishwasher into the WiFi network or want to do it later.
- If you select Yes, the next steps will guide you through the process to set this up. Please refer to “Further settings, Networking/WiFi”.

## Setting the temperature units



- °C  
Temperature display in Celsius.
- °F  
Temperature display in Fahrenheit.
- Tap to select the option you want.

# Commissioning

## Setting the date



- Use the  $\wedge$  and  $\vee$  arrow buttons to set the year.

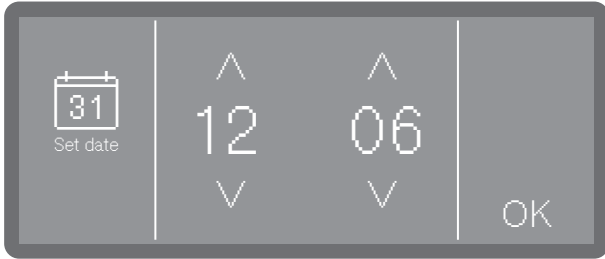

- Use the  $\wedge$  and  $\vee$  arrow buttons to set the day and the month.
- Press OK to save the setting.

## Setting the time of day

The time of day is set in the set time of day format.

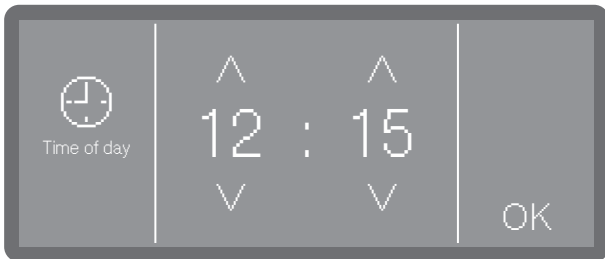

- Use the  $\wedge$  (higher) and  $\vee$  (lower) arrow buttons to set the time of day and confirm your selection by pressing OK.

## Setting the water hardness

Your local water authority can give you information about the exact water hardness in your area.

With varying water hardness, always set the highest level. If the water hardness fluctuates between, for instance, 1.4 and 3.1 mmol/l (8 and 17 °dH), the water hardness must be set to 3.1 mmol/l (17 °dH).

The water hardness setting values can be found in the chart in “Filling the salt container”.

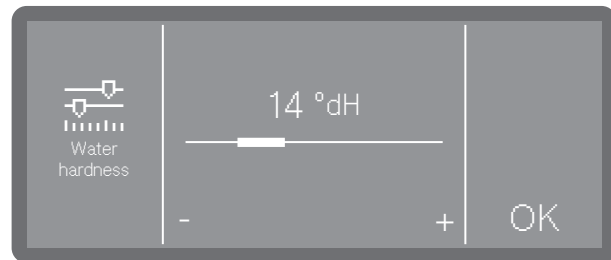

- Set the water hardness level by tapping the - symbol (lower) and + symbol (higher).
- Press OK to save the setting.

In the event of a fault, it will help the service technician if you know the hardness of your local water supply. Document the water hardness in “Filling the salt container”.

## Selecting water connections

This option is only available for dishwashers with more than one water connection (depending on the model).

All available water connections are activated in the control system ex-works. Individual water connections can be subsequently deactivated, e.g. if no connection options are available for them.

Following commissioning, the water connections can be reinstated by the Miele Customer Service Department.

- Select one of the available water connections, e.g.:

- Hot water

Hot water connection

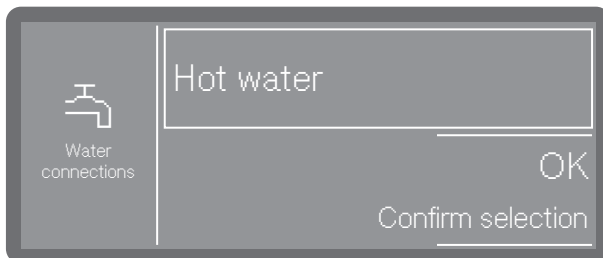

The frame indicates the activated water connection. Tapping the connection removes the frame and permanently deactivates the water connection.

- Select OK to confirm your choice.

## Commissioning completed

Your machine has been successfully set up once you see the following message.

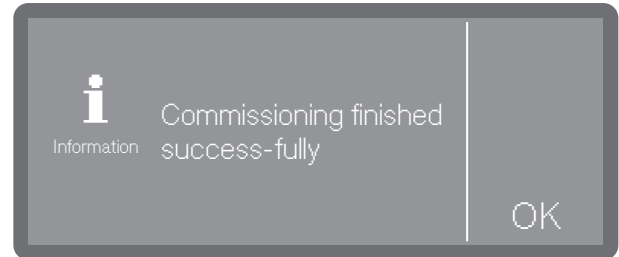

- Confirm the message with OK.

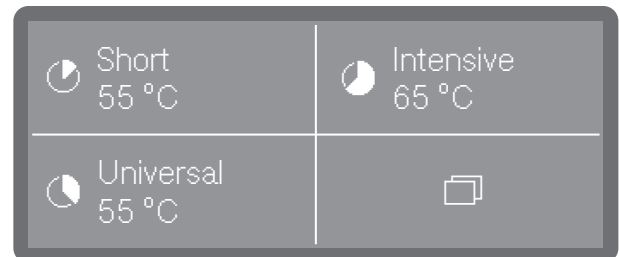

The dishwasher is now ready for operation.

# Opening and closing the door



## Comfort door lock

The door of the wash cabinet is equipped with a Comfort door locking mechanism. When the door is closed, the Comfort door locking mechanism automatically pulls the door into the closed position and thus ensures it is sealed. The door is locked electronically.

### Open the door

⚠ Damage due to leaking water.  
The door of the dishwasher must not be opened during operation.  
Once the programme has started, leave the door closed to ensure that no water drips out.

A door that has been locked electronically can be opened under the following circumstances:

- The machine is connected to the power supply and switched on (the  LED is lit up)
- The  LED is lit.
- Press the  button to open the door.

The comfort door lock opens the door slightly. The LED in the button goes out as soon as the door is unlocked.

The dishwasher control panel also serves as a door handle.



- Grasp the handle underneath the control panel and pull the door down to open it.

## Closing the door

- Make sure that no objects or load items protrude into the closing area of the door.

⚠ Risk of injury caused by crushing.  
Do not put your hand inside the door as it is closing. Risk of crushing.

- Raise the door upwards until the catch engages.

The door is then drawn into its final close position.



### Opening the door using the emergency release

The emergency release may only be used when it is no longer possible to open the door normally, e.g. in the event of a power failure.

**⚠ Danger of scalding, burning and chemical burns!**

If the emergency release is operated during a programme sequence, hot water and process chemicals can escape.

Only open the door using the emergency release when strictly necessary.

The emergency release mechanism is located on the right beside the door lock in the gap between the door and the lid of the machine or the worktop.

The right-hand edge of the tool should ideally be aligned with the right-hand edge of the display.

- Press against the door to release the emergency release mechanism.



- Insert the tool from the accessory pack horizontally into the gap between the door and the lid or worktop.
- Press the tool against the release mechanism until you hear the door open. Continue to press the tool against the release mechanism and fully open the door.

If the machine is switched on, the following message is shown on the display when the emergency release is triggered:

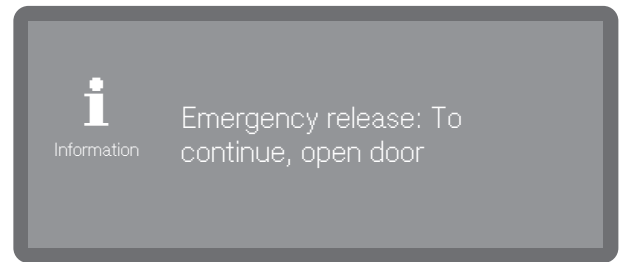

The message is acknowledged when the door is closed.

# Filling the container for dishwasher salt

## Water hardness

In order to achieve excellent cleaning results, the machine requires a supply of soft water with a low calcium content. Hard mains water results in the build-up of calcium deposits on the load items and on the wash cabinet walls.

Mains water with a water hardness of 0.7 mmol/l (4 °dH) or more must be softened. This occurs automatically during a programme sequence in the built-in water softener.

The water softener must be set to the exact hardness of the mains water (see “Setting the water hardness”).

Your local water authority can give you information about the exact water hardness in your area.

In the event of a fault, it will help the service technician if you know the hardness of your local water supply. Record the hardness of the mains water here:

\_\_\_\_\_ mmol/l or °dH

The water softener must be reactivated at regular intervals. Special dishwasher salt is required for this. Reactivation is carried out automatically during a programme sequence.

If the hardness level of your water is consistently less than 0.7 mmol/l (= 4 °dH), salt is not required for the water softener. However, the water hardness level must still be set.

## Setting the water hardness

Water hardness can be set between 0 and 12,5 mmol/l (0–70 °dH).

The water hardness is preset to 2.5 mmol/l (14 °dH) ex-works.

## Setting the water hardness

Water hardness can be set between 0 and 12,5 mmol/l (0–70 °dH).

The water hardness is preset to 2.5 mmol/l (14 °dH) ex-works.

With varying water hardness, always set the highest level. If the water hardness fluctuates between, for instance, 1.4 and 3.1 mmol/l (8 and 17 °dH), the water hardness must be set to 3.1 mmol/l (17 °dH).

Water hardness setting values can be found in the chart on the next page.

The menu is saved under the following input path.

Further choices

Extended settings

Water hardness

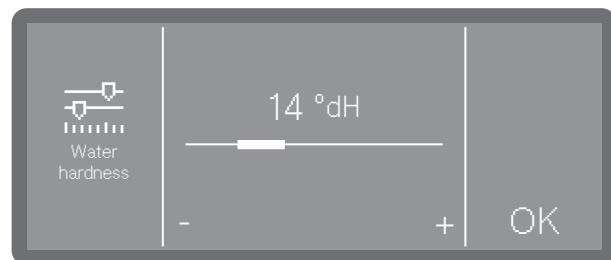

■ Set the water hardness level by tapping the - symbol (lower) and + symbol (higher).

■ Press OK to save the setting.

# Filling the container for dishwasher salt

## Settings table

°dH	°f	mmol/l	Display
0	0	0	<b>0</b>
1	2	0.2	<b>1</b>
2	4	0.4	<b>2</b>
3	5	0.5	<b>3</b>
4	7	0.7	<b>4</b>
5	9	0.9	<b>5</b>
6	11	1.1	<b>6</b>
7	13	1.3	<b>7</b>
8	14	1.4	<b>8</b>
9	16	1.6	<b>9</b>
10	18	1.8	<b>10</b>
11	20	2.0	<b>11</b>
12	22	2.2	<b>12</b>
13	23	2.3	<b>13</b>
14	25	2.5	<b>14</b>
15	27	2.7	<b>15</b>
16	29	2.9	<b>16</b>
17	31	3.1	<b>17</b>
18	32	3.2	<b>18</b>
<b>19</b>	<b>34</b>	<b>3.4</b>	<b>19 *)</b>
20	36	3.6	<b>20</b>
21	38	3.8	<b>21</b>
22	40	4.0	<b>22</b>
23	41	4.1	<b>23</b>
24	43	4.3	<b>24</b>
25	45	4.5	<b>25</b>
26	47	4.7	<b>26</b>
27	49	4.9	<b>27</b>
28	50	5.0	<b>28</b>
29	52	5.2	<b>29</b>
30	54	5.4	<b>30</b>
31	56	5.6	<b>31</b>
32	58	5.8	<b>32</b>
33	59	5.9	<b>33</b>
34	61	6.1	<b>34</b>
35	63	6.3	<b>35</b>

°dH	°f	mmol/l	Display
36	65	6.5	<b>36</b>
37	67	6.7	<b>37</b>
38	68	6.8	<b>38</b>
39	70	7.0	<b>39</b>
40	72	7.2	<b>40</b>
41	74	7.4	<b>41</b>
42	76	7.6	<b>42</b>
43	77	7.7	<b>43</b>
44	79	7.9	<b>44</b>
45	81	8.1	<b>45</b>
46	83	8.3	<b>46</b>
47	85	8.5	<b>47</b>
48	86	8.6	<b>48</b>
49	88	8.8	<b>49</b>
50	90	9.0	<b>50</b>
51	92	9.2	<b>51</b>
52	94	9.4	<b>52</b>
53	95	9.5	<b>53</b>
54	97	9.7	<b>54</b>
55	99	9.9	<b>55</b>
56	100	10.0	<b>56</b>
57	102	10.2	<b>57</b>
58	104	10.4	<b>58</b>
59	106	10.6	<b>59</b>
60	107	10.7	<b>60</b>
61	109	10.9	<b>61</b>
62	111	11.1	<b>62</b>
63	113	11.3	<b>63</b>
64	115	11.5	<b>64</b>
65	116	11.6	<b>65</b>
66	118	11.8	<b>66</b>
67	120	12.0	<b>67</b>
68	122	12.2	<b>68</b>
69	124	12.4	<b>69</b>
70	125	12.5	<b>70</b>

\*) Factory default setting

## Filling the container for dishwasher salt

### Salt refill indicator

If the level in the salt container is low and a reactivation is carried out, the following message appears on the display:

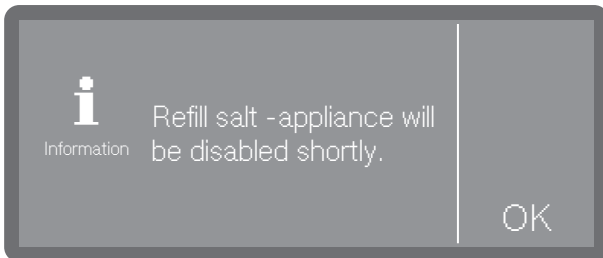

- Confirm the message with *OK*.
- Fill the salt container as described.

If the message is being displayed for the first time, further programme runs may be possible depending on the set water hardness. If no salt is added, the message is displayed again at the end of every programme.

### Reactivation notification

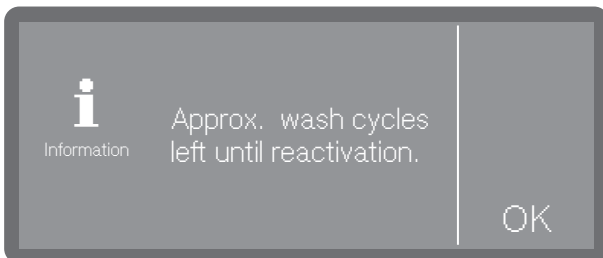

You can set how many cleaning cycles in advance you want to be notified of the upcoming reactivation, see “Extended settings”, “Reactivation notification”.

### Machine blocked if salt is not available

If the salt in the water softener has been used up, a fault appears on the display and the machine blocked from performing further applications.



Acknowledge the fault by tapping on the warning symbol. Then follow the instructions on the display:

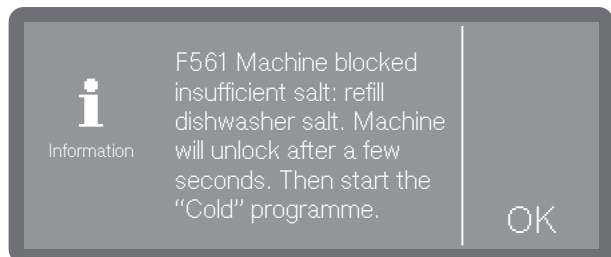

- Fill the salt container as described.

The machine lock is lifted with a delay of a few minutes once salt has been added.

## Filling the container for dishwasher salt

### Filling the salt container

Filling the salt reservoir Use only special, coarse-grained salt with a granula size of approx. 1- 4 mm.

Do not under any circumstances use other types of salt such as table salt, agricultural or gritting salt. These may contain insoluble additives which can impair the functioning of the water softener.

⚠ Inadvertently filling the salt reservoir with cleaning agent will cause serious damage to the water softener. Before filling the salt container make sure that you have picked up the right packet of reactivation salt.

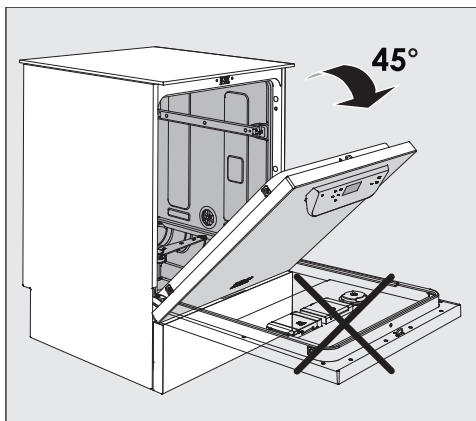

- When filling the salt container, **only open the door halfway** to ensure that all the salt gets into the container.

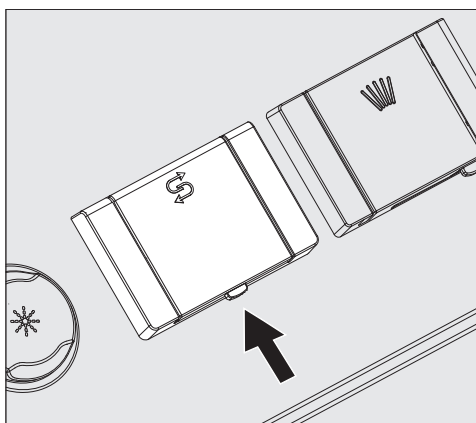

- Press the open button on the lid of the salt container in the direction of the arrow. The flap will spring open.
- Open the funnel.

Do **not** pour any water into the salt container!

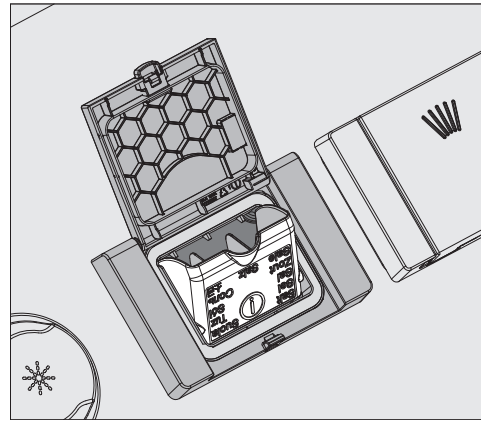

- Add salt into the container until the funnel is full but still closes easily. The salt container will take approx. 2 kg of salt on the first fill depending on the degree of coarseness. Subsequent refills may take less salt, as there may still be salt remaining in the container.

If there is water present in the container, it may be forced out by the added salt.

- Clean any excess salt from around the container opening and the seal surrounding it, and then close the flap.
- To avoid corrosion in the wash cabinet, run the **Cold** programme (without any load items) immediately after refilling the salt container. This will dilute and rinse away any remaining traces of salt.

# Loading the dishwasher

---

## Loading the dishwasher

Remove coarse food residues from crockery.

There is no need to pre-wash items under running water.

### Notes

⚠ Risk of damage caused by acids and solvents.

Acid or solvent residues, especially hydrochloric acid or chlorides, must not get inside the wash cabinet.

Do not put acids or solvents in the wash cabinet.

⚠ Damage caused by items soiled with ash, sand, wax, lubricant or paint

These materials will cause damage to the dishwasher.

Do not wash items soiled with ash, sand, wax, lubricant or paint in the dishwasher.

Load crockery and cutlery into the appropriate places in the baskets, observing the following notes:

- Load the crockery so that water can access all surfaces. This ensures thorough and proper cleaning.
  - Load plates symmetrically in the upper and lower baskets with the concave surfaces facing the centre of the basket (as shown on the following pages).
  - Do not place crockery and cutlery inside other items. They will cover one another.
  - Make sure that all items are securely positioned.
  - Hollow items such as cups, glasses, pans, etc. must be inverted in the basket.
  - Tall, narrow, hollow items should be placed in the centre of the basket if possible. This ensures better water coverage.
  - Wide-based items should ideally be placed at an angle so that water can run off them freely.
- The spray arms must not be blocked by items which are too tall or hang through the baskets. If in doubt, test for free movement by manually rotating the spray arms.
  - If you need to wash large load items in the lower basket, you can remove the upper basket.
  - Small items can fall through the holders in the baskets. They should therefore be placed in the cutlery basket.

### Items not suitable for dishwashers

- Wooden cutlery and crockery or items with wooden parts may discolour or fade. The glue used in these items is not dishwasher-proof. Wooden parts may come loose after being washed in a dishwasher.
- Craft items, antiques, valuable vases and decorative glassware are not dishwasher-safe.
- Plastic items which are not heat resistant may melt or lose shape.
- Copper, brass, tin and aluminium items may discolour or become matt.
- Colours painted over a glaze may fade after a number of washes.
- Delicate glasses and glassware containing crystal may become cloudy over time.

### We recommend

- When purchasing new crockery and cutlery, make sure they are dishwasher-safe if you want to wash them in the dishwasher.
- Clouding may occur on glasses after frequent washing in the dishwasher. When washing delicate glasses in the dishwasher, ensure that only a special glass-care programme with very low temperatures (see “Programme chart”) is selected and that a suitable cleaning agent is used. This will reduce the risk of clouding.

### Please note:

Silver and aluminium which has been in contact with foods containing sulphur can discolour.

 Risk due to chemical reaction  
Aluminium components (e.g. grease filters) must not be cleaned in the dishwasher with caustic alkaline commercial or industrial cleaning agents. These may damage the material. In extreme cases, they can cause a severe chemical reaction (such as an explosive oxyhydrogen gas reaction).  
Do not clean pretreated aluminium components in the dishwasher.

# Loading the dishwasher

## Upper basket

Use the upper basket for small, lightweight and delicate items such as cups, saucers, glasses, dessert bowls etc. Light, heat-resistant plastic items can also be loaded in the upper basket.

Smaller shallow pots and pans can also be washed in the upper basket.

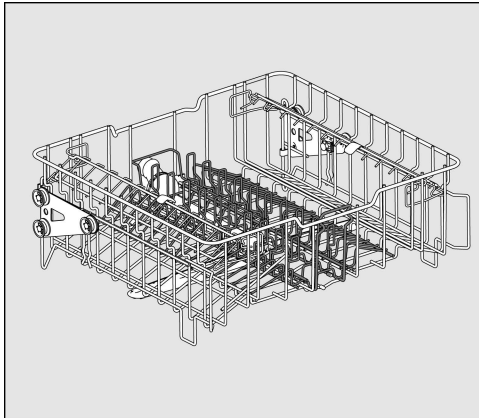

APFD 215 upper basket with APFD 415 insert

The middle insert can be removed from the upper basket to wash larger pots and pans or to replace it with other inserts.

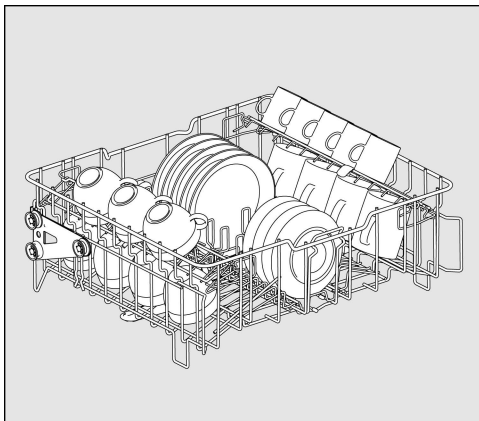

With APFD 415 insert for 20 cups and 32 saucers or 18 dessert plates and 20 cups, for example.

## Cup rack

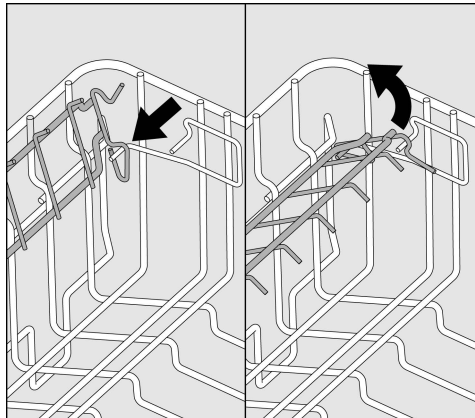

You can fold up the cup rack to place large cups, glasses and mugs in the upper basket.

- Fold up the cup rack.

The upper basket can be removed in order to wash larger items in the lower basket (e.g. serving dishes).



## Adjusting the upper basket

In order to obtain more space for taller items in the lower or upper basket, the upper basket can be adjusted between two positions that are approx. 5 cm apart.

- Pull out the upper basket.

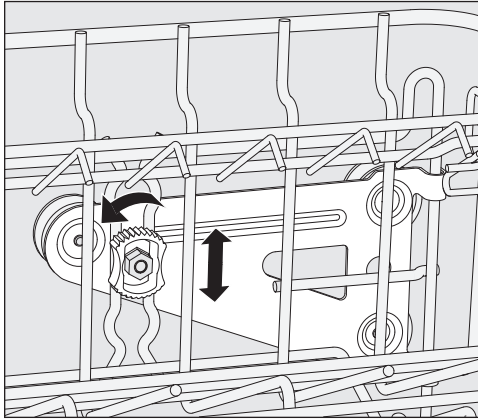

- Unscrew the fixing nuts on both sides.
- Lift or lower the basket into the desired position.
- Tighten the fixing nuts again.

The upper basket must be level in both positions.

If the upper basket is inclined, a water connection is not possible.

⚠ Damage caused by the water connection being positioned incorrectly. The position of the water connection needs to be adjusted after the height of the upper basket has been changed. When changing the height of the upper basket, always adjust the water connection accordingly before pushing the upper basket back in.

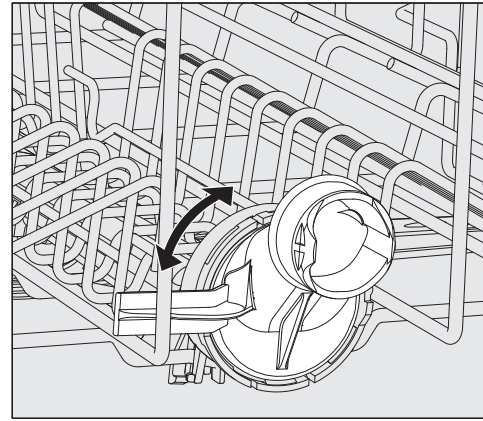

- Turn the upper basket water connection to the upper or lower position. The water connection must click audibly into place.

Depending on the position of the upper basket, the following plate dimensions can be accommodated:

Example with APFD 215 upper basket:

Upper basket position	Upper basket plate Ø	Lower basket plate Ø
Top	Max. 15 cm	33 cm*
Bottom	Max. 20 cm	25 cm

\* The E 816 plate insert is required in the lower basket.

# Loading the dishwasher

## Lower basket

Place larger and heavier load items such as plates, serving platters, pots, bowls, etc. in the lower basket.

Only place thin, delicate glasses in a suitable insert or lower basket.

Always arrange plates with the top side facing inwards, as shown in the pictures, to achieve the best cleaning result.

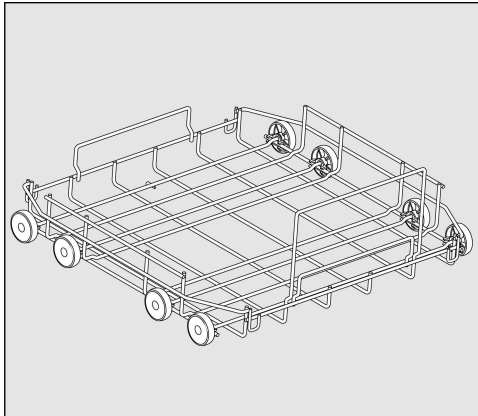

APFD 220 lower basket carrier

For plastic trays, various inserts and cutlery inserts.

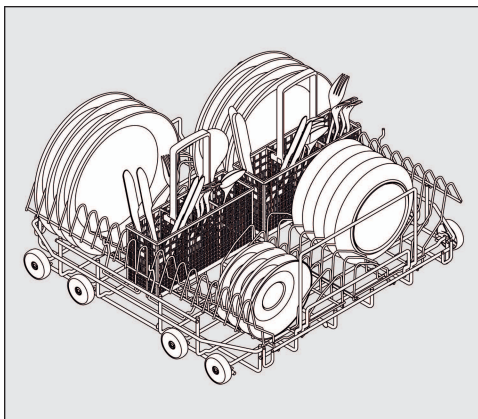

APFD 220 lower basket with 2 x E 816 inserts and 2 x APFD 420 cutlery inserts

32 plates each with Ø 25 cm and various items of cutlery can be loaded. Without cutlery inserts, 38 plates each with Ø 25 cm can be loaded into the E 816 inserts.

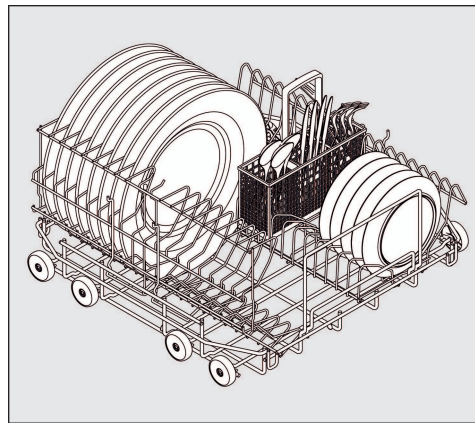

APFD 220 lower basket with an E 816 insert rotated 90°

With the APFD 420 cutlery insert, 32 plates each with Ø 33 cm and various items of cutlery can be loaded. Without the cutlery insert, 38 plates each with Ø 33 cm can be loaded into the rotated E 816 insert.

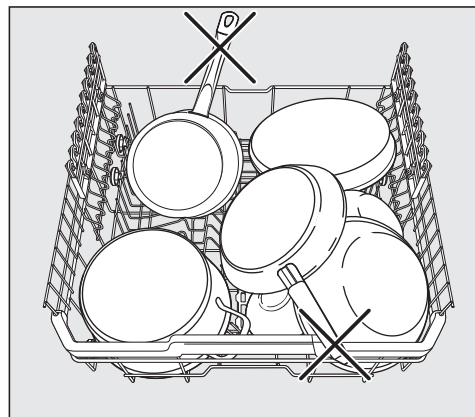

**Damage due to protruding items**  
Protruding items can damage the interior of the dishwasher.  
When loading the baskets, make sure that no parts, such as handles, are protruding over the edge of the baskets.

## Loading plastic trays

The APFD 220 lower basket carrier can be loaded with plastic trays measuring 500 x 500 mm.

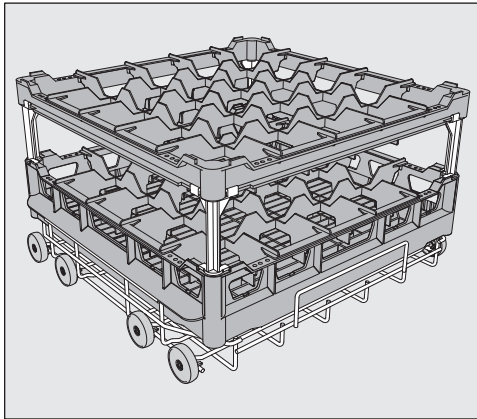

The special O 885 upper basket carrier is required for loading plastic trays in the upper basket (max. height for load items is 130 mm).

The special U 876 lower basket carrier is required for loading taller load items in the lower basket.

Which basket combination to use will depend on the type, shape and size of the load items to be washed.

For further information on baskets, please contact your Miele dealer or the Miele Customer Service Department.

Examples: (lower baskets)

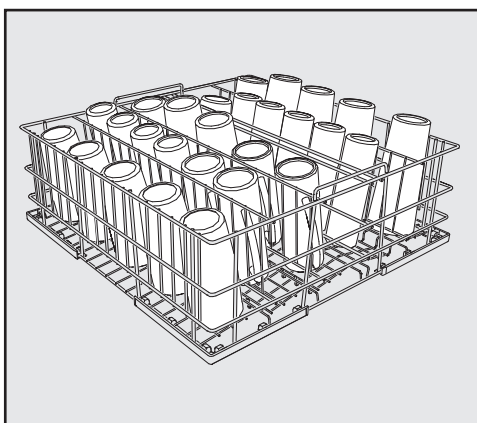

U 525/5-row wire basket

The wire basket can be used for glasses with a maximum diameter of 8 cm.

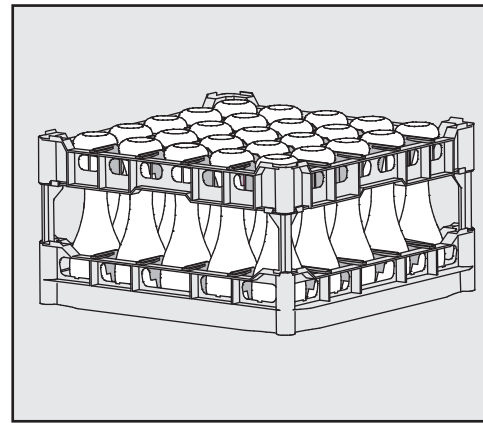

U 534–U 537 plastic trays with compartments for different glass heights

In this example, the plastic tray is connected to the top frame by long extenders.

(For assembly in U 876 lower basket carrier only)

## Assembling a plastic tray

The height of the tray can be altered by fitting a top frame ① to the base basket ④ with long ② or short ③ extenders.

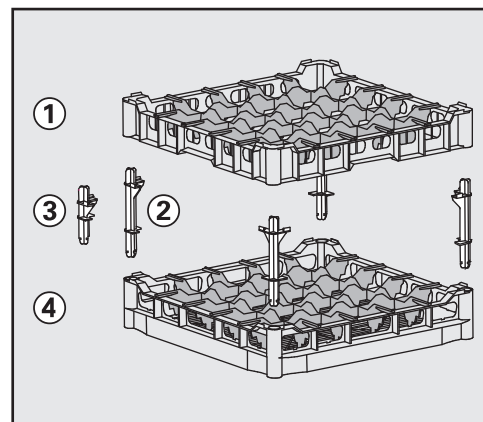

- Push all four extenders into the base basket ④.
- Press the top frame ① securely onto the extenders.

# Cleaning agent and rinsing agent

## Dispensing systems

⚠ Risk to health due to process chemicals.  
Some process chemicals may be corrosive and irritant substances. Swallowing process chemicals can cause chemical burns in the mouth and throat or lead to asphyxiation. If process chemicals get into the eyes, they can irritate or burn them.  
Observe the relevant safety regulations issued by the process chemical manufacturers when handling process chemicals and take all the protective measures stipulated by the process chemical manufacturers.

Depending on the model, dishwashers are equipped with multiple dispensing systems for process chemicals:

### - Cleaning agent

Cleaning agent can be dispensed in powder form, as a tablet or in liquid form. Powder cleaning agent and tablets are dispensed via the door dispenser with the  symbol. Depending on the model, liquid cleaning agent is dispensed either via an internal dispensing system or via an external dispensing module (DOS module).

### - Rinsing agent

Depending on the model, rinsing agent can be dispensed via the door dispenser with the  symbol or via an external dispensing module (DOS module).

External dispensing modules (DOS modules) can be retrofitted at any time by the Miele Customer Service Department, provided that corresponding DOS module connections are available.

## Dispensing module

In addition to the internal dispensing systems, up to two additional external dispensing systems (modules) DOS can be connected for dispensing liquid process chemicals.

### Labelling of the siphons

Liquid process chemicals from external containers are dispensed by siphons. Colour coding the siphons can be helpful for correct dispensing.

Specific types of soiling may require different combinations of cleaning agents and additives. The Miele Customer Service Department will be able to advise you.

### Connecting dispensing modules

The dispensing module is supplied with its own installation instructions.

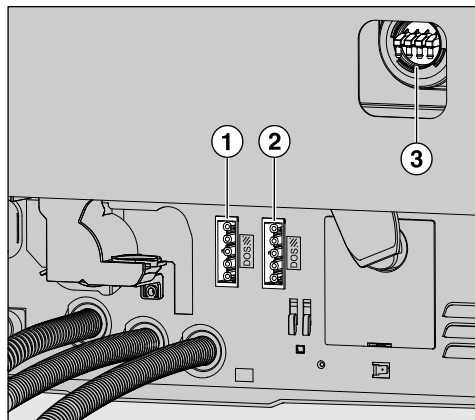

- ① Power supply connection for DOS 1, cleaning agent (depending on the model).
- ② Power supply connection for DOS 4, rinsing agent (depending on the model).
- ③ Connections for dispensing hoses.

⚠ Damage caused by incorrect voltage. Before fitting the dispensing module, compare the connection data (voltage and frequency) on the module data plate with that on the data plate of your dishwasher. If the data does not match, the module could sustain damage. If in any doubt, consult a qualified electrician.

- Connect the module to the machine's power supply.
- To connect the dispensing hoses, release the hose clip on a free connector and remove the safety cap.
- Push the dispensing hose onto the connector and secure it with a hose clip.

Blank off unused connectors for dispensing hoses with safety caps to prevent the leakage of wash water.

### Cleaning agent

Only use cleaning agent suitable for commercial dishwashers. Suitable products are available from the Miele Professional product range.

Cleaning agent can be dispensed in powder form, as a tablet or in liquid form.

Powder cleaning agent and tablets are dispensed via the door dispenser with the  symbol.

Only use cleaning agent tablets that are quick dissolving. Suitable tablets are available from the Miele Professional product range.

Liquid cleaning agent is dispensed from an external canister via a suction lance.

Depending on the model, liquid cleaning agent is dispensed either via an internal dispensing pump or via an external dispensing module. Dispensing modules are connected by the Miele Customer Service Department and can be retrofitted at any time.

### Replacing the canister

- Place the liquid cleaning agent container (note the colour marking) on the open wash cabinet door or on a surface which is robust and easy to clean.
- Take the lid off the canister and remove the suction lance. Place the suction lance on the open wash cabinet door.
- Replace the empty container with a full one.

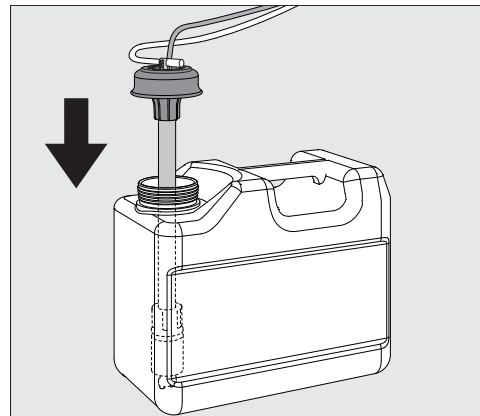

# Cleaning agent and rinsing agent

- Push the suction lance into the opening of the container and secure the lid. Observe the colour coding.
- Feed the suction lance into the container until it reaches the bottom.
- Wipe up any spilled process chemical thoroughly.

## Refill indicator

When the fill level in the cleaning agent canister is low, you are reminded to change the canister.

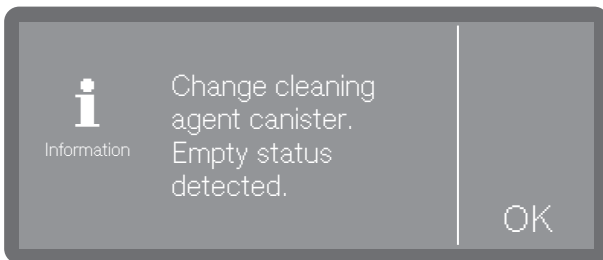

- Confirm the prompt with *OK* and change the cleaning agent canister.
- Fill the dispensing path (see “Machine functions”)

## Checking consumption

Check consumption regularly by checking the fill levels in the supply containers and replace containers in good time to avoid the dispensing system being sucked completely dry.

## Dispensing liquid cleaning agent

The dispensing concentration is set by the Miele Customer Service Department.

## Filling the door dispenser

⚠ Risk to health due to dust production. When dispensing powder cleaning agents and tablets, dust from fine cleaning agents can be stirred up. If this dust gets into the mouth, throat or eyes, it can cause irritation or burns. When dispensing powder cleaning agents and tablets, avoid the production of dust as much as possible.

Add powder cleaning agent or a tablet to the powder cleaning agent dispenser before every wash programme (except Super Short, Cold, Reactivation and Drain). Follow the tips on the Super Short programme.

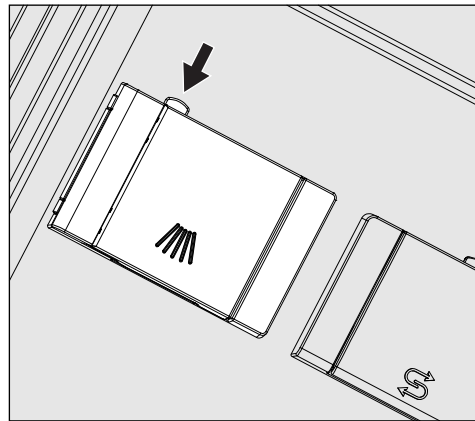

- Press the yellow button on the dispenser container with the  symbol.

The flap will spring open. The flap is always open at the end of a programme run.

The level markers in the powder container with the door in the horizontal position indicate the fill level in millilitres (ml). The max. capacity is approx. 60 ml of cleaning agent.

The amount in ml equates to approx. the amount normally recommended in grams (g) for proprietary powder cleaning agents.

Powder density (grain size) can affect this amount.

### Dispensing example:

Approx. 8,5 litres of water are taken into the machine for the main wash. With a cleaning agent concentration of approx. 3 g/l, you will need approx. 25 g of cleaning agent. Please observe manufacturer's recommendations, which may vary!

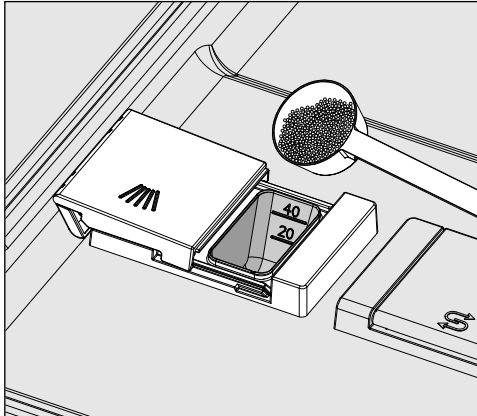

- Add the cleaning agent to the dispenser.

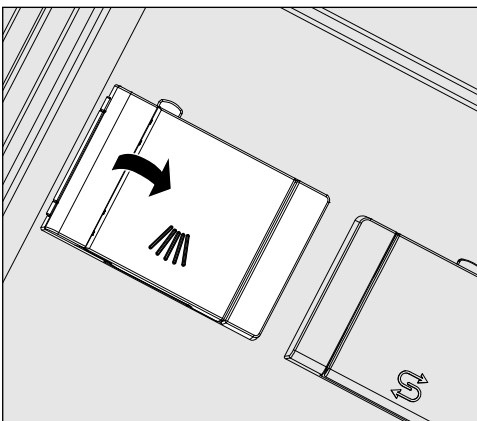

- Close the flap.

⚠ Make sure that all of the cleaning agent has dissolved at the end of the programme.

Repeat the programme if residual cleaning agent is present.

Check whether any load items have prevented the flushing out of the dispenser container and rearrange the load items if necessary.

### Tips for the Super Short programme (depending on the model)

With the Super Short programme, the final rinse water is not pumped away at the end of the programme in order to achieve short programme running times in continuous use.

Cleaning agent cannot be rinsed out of the dispenser during the short programme time.

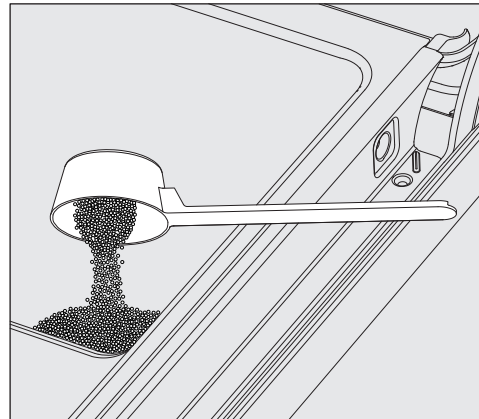

- If liquid cleaning agent dispensing is not being used, add powder cleaning agent directly onto the inside of the door.

To avoid corrosion or discolouration, start the wash programme immediately after dispensing cleaning agent directly onto the inside of the door.

# Cleaning agent and rinsing agent

## Rinsing agent

Rinsing agent is necessary to ensure water does not cling and leave marks on load items, and to help load items dry faster after the final rinse.

The rinsing agent concentration must be adjusted in the following circumstances:

- If there are spots of water left on load items after reprocessing, then the dispensing concentration is set too low.
- If clouding or smearing appears on load items, the dispensing concentration is set too high.

The rinsing agent is dispensed in the Final rinse programme stage. The container needs to be filled for this purpose.

In the Beer glasses programme (depending on the model), the final rinse is carried out with cold water and without rinsing agent.

## Replacing the canister

- Place the rinsing agent container (note the colour marking) on the open wash cabinet door or on a surface which is robust and easy to clean.
- Take the lid off the canister and remove the suction lance. Place the suction lance on the open wash cabinet door.
- Replace the empty container with a full one.

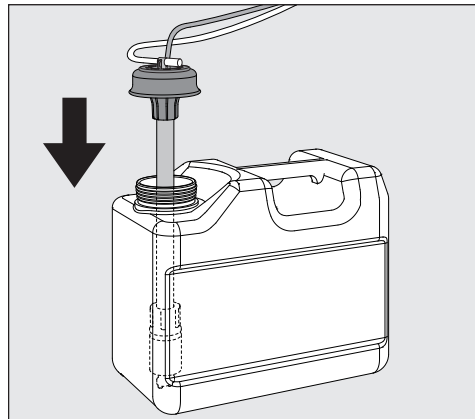

- Push the suction lance into the opening of the container and secure the lid. Observe the colour coding.
- Feed the suction lance into the container until it reaches the bottom.
- Wipe up any spilled process chemical thoroughly.



## Refill indicator

When the fill level in the rinsing agent container is low, you are reminded to change the canister, e.g.:

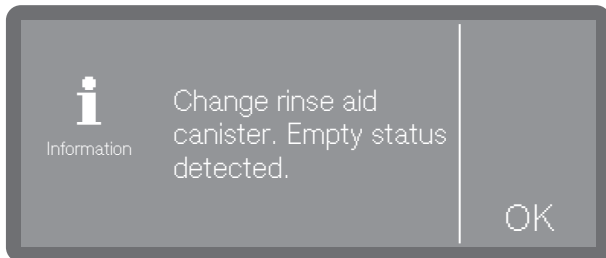

- Confirm the prompt with *OK* and change the rinsing agent canister as described.
- Fill the dispensing path (see “Machine functions”)

## Filling the door dispenser

⚠ Never add cleaning agent. This will always destroy the rinsing agent container! Only fill the rinsing agent container with rinsing agent for commercial dishwashers.

- Open the door fully.

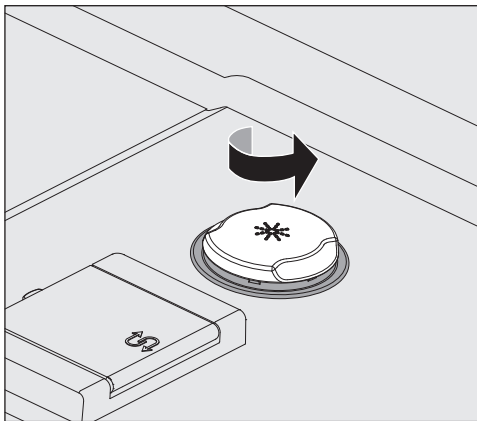

- Unscrew the yellow lid with the \* symbol in the direction of the arrow.

The container holds approx. 300 ml.

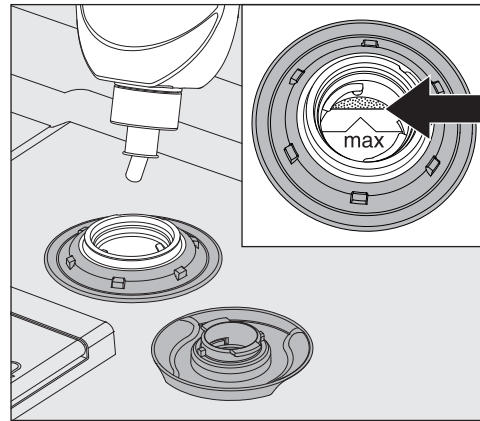

- Only add rinsing agent as far as the “max.” mark on the edge of the funnel.

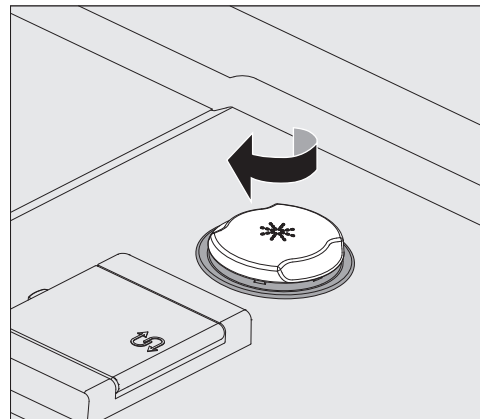

- Close the container.
- Wipe up any spilled rinsing agent thoroughly. This prevents over-foaming during the next programme. Alternatively, you can start the Cold programme to rinse off any spilled rinsing agent.

# Cleaning agent and rinsing agent

---

## Refill indicator

When the fill level in the rinsing agent container is low, you are reminded to refill the dispenser container, e.g.:

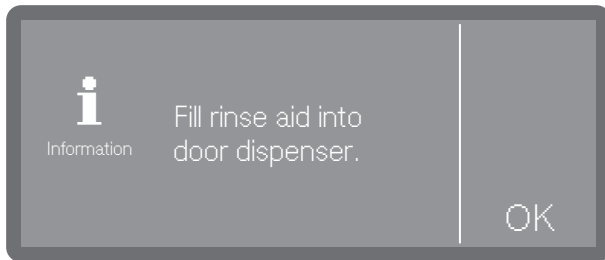

- Confirm the prompt with *OK* and top up the rinsing agent as described.
- Fill the dispensing path (see “Machine functions”)

## Dispensing rinsing agent

The dispensing concentration is set by the Miele Customer Service Department.

- If there are spots of water left on load items after reprocessing, then the dispensing concentration is set too low.
  - If clouding or smearing appears on load items, the dispensing concentration is set too high.
- In either case contact the Miele Customer Service Department and have the dispensing concentration reset.



## Switching on

- Open the stopcock if it is closed.

The dishwasher needs to be connected to the electricity supply.

- Press and hold the  button until the following appears on the display:



As soon as the dishwasher is ready for operation, the display message changes to show the programme selection screen, e.g.:

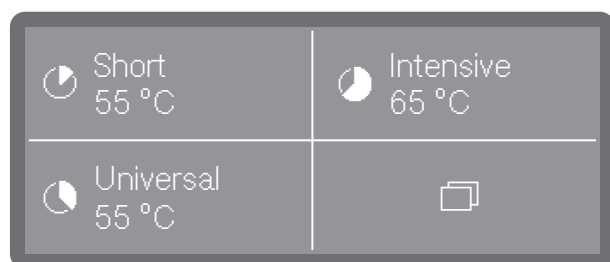

If the Memory function is activated, the most recently started programme is displayed, e.g.:

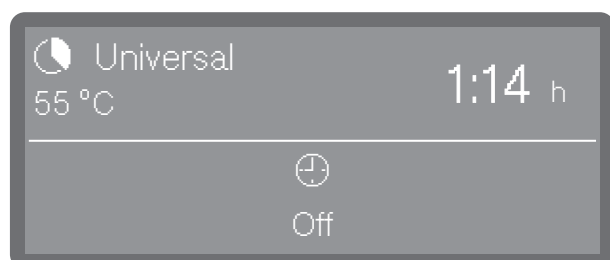

## Selecting a programme

Choose your programme according to the type of load items and the degree of soiling.

As soon as you have selected a programme, the LED for the *Start/Stop* button starts to flash.

Use the  button to return to the programme selection screen before the programme starts, e.g. to select a different programme. This is no longer possible once the programme has started. If necessary, you must cancel the programme (see “Cancelling a programme”).

## Selecting favourites

Frequently used programmes can be set as favourites. 1 to 3 favourites can be shown on the display and selected directly from here. The buttons can be freely customised to suit individual needs (see “Favourites”).



- Select a programme directly on the display.

The most recently selected programme will appear on the display if the memory function is activated. In this case, the programme can be started immediately by pressing the *Start/Stop* button.

# Operation

## Programme list

Programmes which cannot be selected directly on the display can be selected from the programme list.

- Press the  Further choices button.
- Then select  Further progs.

The following options menu appears on the display:

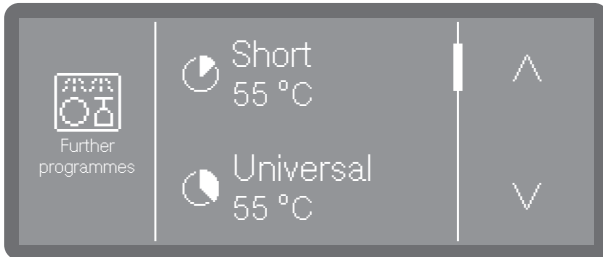

- Scroll through the list using the  $\wedge$  and  $\vee$  buttons and select one of the programmes.

The selected programme will be shown on the display, e.g.:

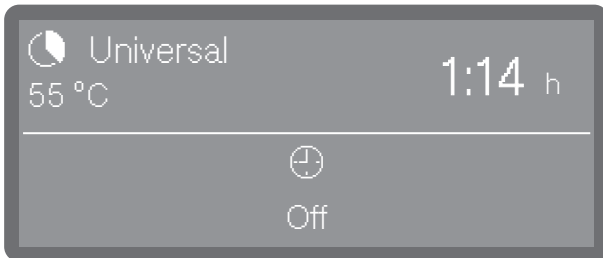

The *Start/Stop* button starts flashing.

## Starting a programme

- Press the *Start/Stop* button (the LED of the *Start/Stop* button will light up).

## Starting the programme using a timer

The start of a programme can be delayed, for example, to benefit from economy rates of electricity at night. You can set a start time at which the programme should start (Start at) or a finish time by which the programme should end at the latest (Finish at). The times are set based on the set time of day, see “Time of day”.

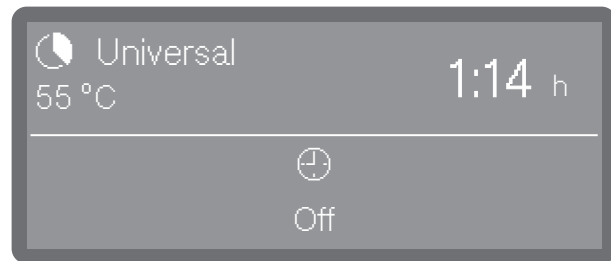

## Setting the timer

- Select a programme.

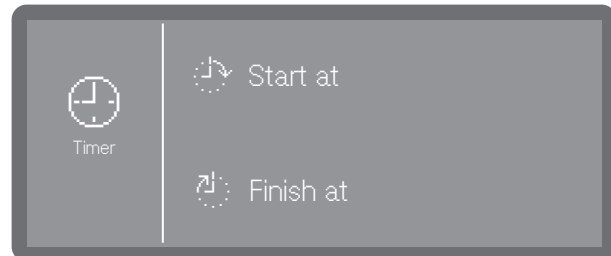

- Tap on  to set the timer.



- Then select the start ( Start at) or finish time ( Finish at).



- Use the  $\wedge$  and  $\vee$  arrow buttons to set the time and confirm your selection by pressing OK.

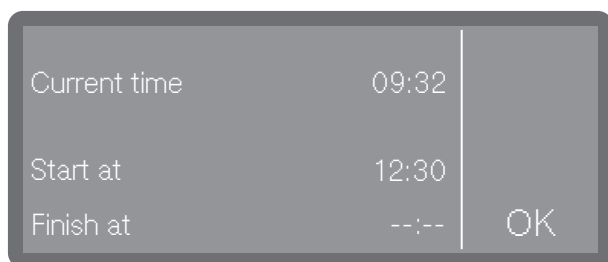

- A summary follows, which you must confirm by pressing OK.

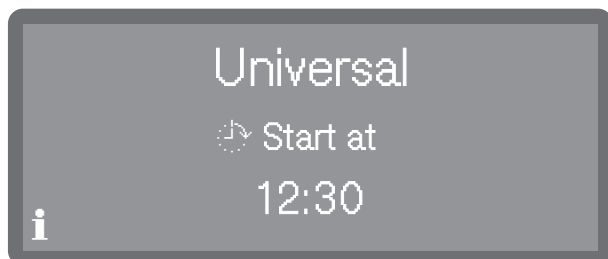

This activates the timer.

### Changing the timer

- If you want to change the time set for the timer, first press the ↩ button to return to the programme view.
- Tap the ⌚ symbol. You can then enter a new start or finish time.

### Deleting the timer

- Press the *Start/Stop* button.

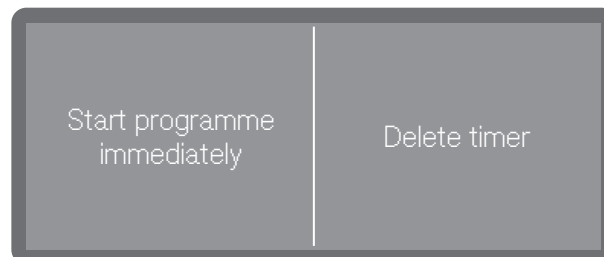

You can either delete the timer setting (Delete timer) or delete the timer and start the programme immediately (Start programme immediately).

Alternatively, you can tap the ⌚ symbol again in the programme view and delete the timer via the settings that follow.

### Programme sequence display

Once a programme has started, the display shows the programme name, the name of the current wash phase and the time left until the programme is finished.

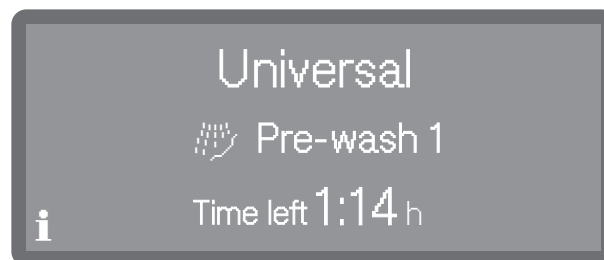

Programme parameters such as the actual and target temperature can be queried during a programme sequence.

- Tap the **i** symbol.

# Operation

## End of a programme

After a programme has ended normally, the LED of the Start/Stop button will go out and the following will appear on the display.



In addition to this, a buzzer will sound for approx. 3 seconds (factory default setting). The buzzer is repeated three times every 30 seconds. To change buzzer settings, see "Volume".

- Tap to acknowledge the display.

If system messages are present, they are displayed afterwards, e.g. if the salt container level or the level of the liquid process chemicals containers was low during the programme, or when the next service is due. Every message needs to be acknowledged individually by pressing *OK*.

## Switching off

- Press the  button until the display turns off.

## Unloading the crockery

Crockery tends to break and chip more easily when it is hot. Allow the items to cool until they are comfortable enough to handle before unloading them from the dishwasher.

If you open the door fully after switching off, the crockery will cool much faster.

Unload the lower basket first, and then the upper basket. This will prevent water drops from the upper basket from falling onto the crockery in the lower basket.

## Interrupting a programme

A programme which is already running should only be interrupted if strictly necessary, e.g. if the load items are moving significantly.

 **Danger of scalding, burning and chemical burns**

The load items, the load carrier and the interior of the wash cabinet may be very hot.

Steam may also escape when the door is opened. Depending on the wash phase, process chemicals may be dissolved within the steam, which can cause irritation and burns in the eyes and respiratory tract.

A programme should only be interrupted if strictly necessary.

Open the door slowly and carefully and avoid contact with the steam that may escape. Touch the load items at your own risk.

 **Damage due to leaking water.**

The door of the dishwasher must not be opened during operation.

Once the programme has started, leave the door closed to ensure that no water drips out.

- Rearrange the load items so that they are stable.
- Close the door again to continue the programme.

The programme automatically continues from the point at which the interruption occurred.



If the temperature inside the wash cabinet is more than 50 °C at this point, the pressure is equalised first. Then the programme continues.

- Open the door (see “Opening and closing the door”).

You will initially be asked whether you really want to open the door.

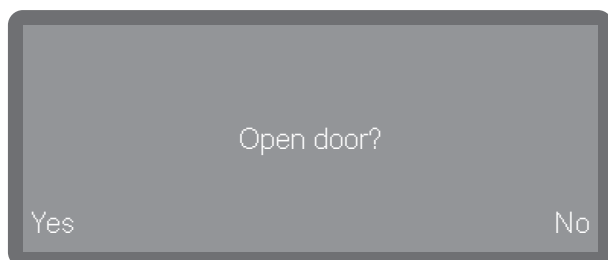

- Select **Yes** to interrupt the programme and open the door.
- Or select **No** to cancel the process. The programme keeps running without interruption.

If the temperature in the wash cabinet is more than 67 °C, the following message alerts you to possible dangers when opening the door.

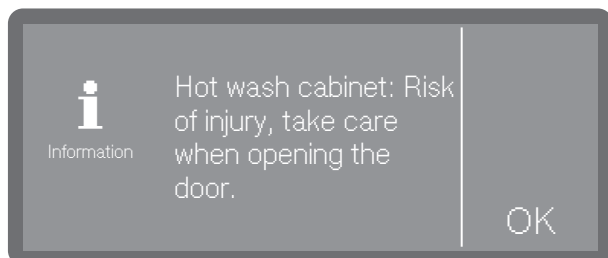

- Confirm the message with **OK**.

## Cancelling a programme

Only cancel a programme which has already started if strictly necessary, e.g. if you want to change the programme.

In the event of a fault, the programme will be cancelled automatically.

⚠ **Damage due to leaking water.**  
The door of the dishwasher must not be opened during operation.  
Once the programme has started, leave the door closed to ensure that no water drips out.

⚠ **Risk of scalding and burning due to hot load items.**  
The load items and the wash cabinet may be very hot.  
Open the door slowly, taking care not to touch the load items or the interior cabinet.

- Press the **Start/Stop** button.

The following will appear on the display:

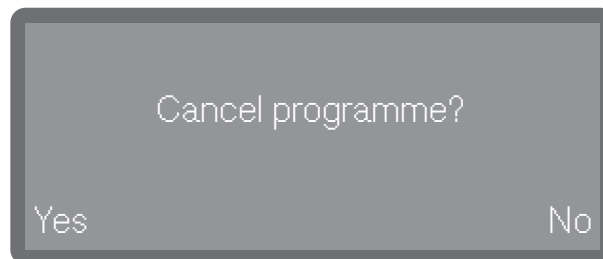

- Select **Yes** and confirm your choice with the **OK** button.

The programme will only be cancelled when **Yes** is confirmed.

The following message will appear on the display:

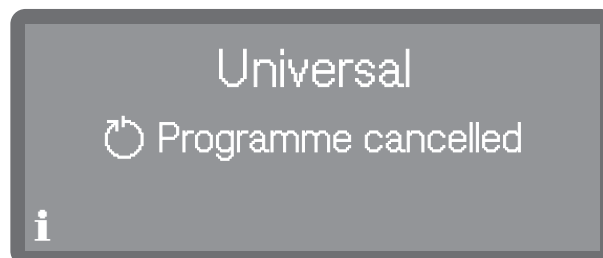

The door needs to be opened.

If you change the programme and the cleaning agent dispenser flap has already opened, add more cleaning agent as needed.

## Machine functions

The  Machine functions menu includes relevant functions to support daily routine tasks.

The factory settings are indicated by a tick ✓. A description of how to configure settings is provided after the overview.

### Menu structure

 Further choices

 Machine functions

 Dispensing systems

 Fill dispensing paths \*)

 Clean. agent canister

 Rinse aid canister

 Rinse dispensing paths \*)

 Clean. agent canister

 Rinse aid canister

\*) Only activated dispensing systems are displayed

### Dispensing paths

The dispensing systems for liquid media can only dispense reliably if the dispensing system has been purged of air and contains no deposits.

#### Filling dispensing paths

The dispensing systems need to be topped up in the following situations:

- If the dispensing system is being used for the first time.
- If air has been sucked in or the system has been drained due to a lack of liquid media.

Before filling the dispensing paths, make sure that the containers are full and that the suction lances are screwed securely to the containers and that they cannot suck in air.

The menu is saved under the following input path.

 Further choices

 Machine functions

 Dispensing systems

 Fill dispensing paths \*)

\*) Only activated dispensing systems are displayed



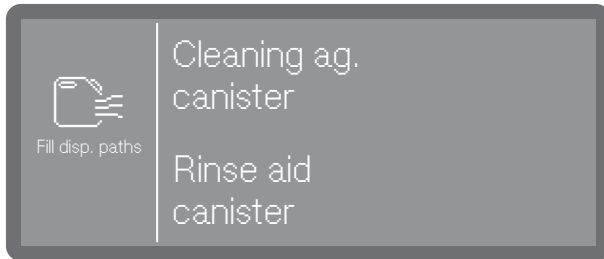

- Clean. agent canister  
Fill the cleaning agent dispensing system.
- Rinse aid canister  
Fill the rinsing agent dispensing system.
- Select the dispensing system that you want to fill.

You will then be asked if you want to start the filling process, e.g.:

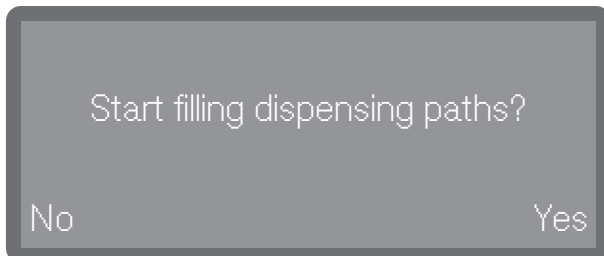

- Select **Yes** to start the process. The dispensing system is filled automatically. The message **Fill dispensing paths completed** is displayed following successful completion. If filling is interrupted prematurely, the process must be repeated.
- Cancel the process at this point by selecting **No**.

### Rinsing dispensing paths

A dispensing system must be rinsed in the following situations:

- If a dispensing system was accidentally filled with the wrong medium.
- If deposits have formed in the dispensing paths or in the containers, which could completely or partially clog the systems. Deposits can form, for example, after long periods of downtime or when the containers are refilled instead of being replaced.
- Fill a clean container, e.g. a bucket, with clear, clean water.

 **Damage to the dispensing system.** Small foreign objects in the water, such as sand, fluff or similar, can be sucked in by the dispensing system and may clog or damage it. Make sure that there are no foreign objects in the water.

- Place the suction lance in the container with the water. The lower end of the suction lance with the suction opening must be thoroughly rinsed.
- Secure the suction lance so that it cannot tip over or fall out of the container.

## Machine functions

---

The menu is saved under the following input path.

 Further choices

 Machine functions

 Dispensing systems

 Rinse dispensing paths \*)

\*) Only activated dispensing systems are displayed

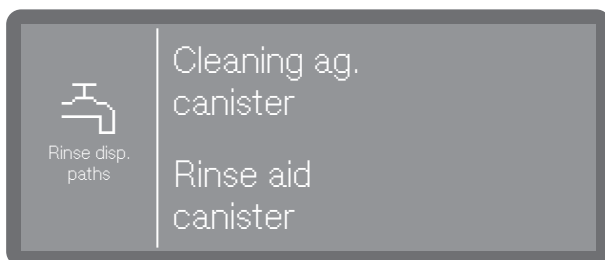

- Clean. agent canister

Rinse the cleaning agent dispensing system.

- Rinse aid canister

Rinse the rinsing agent dispensing system.

■ Select the dispensing system that you want to rinse.

You will then be asked if you want to start the process, e.g.:

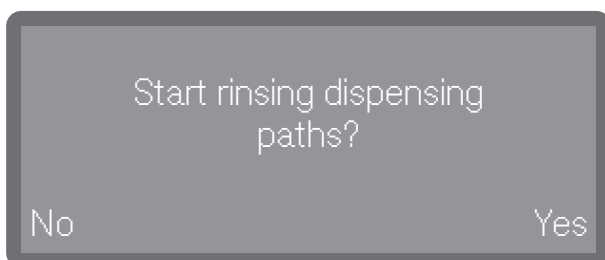

■ Select Yes to start the process.

The dispensing system is rinsed automatically. The message Rinse dispensing paths completed is displayed following successful completion. If rinsing is interrupted prematurely, the process must be repeated.

■ Cancel the process at this point by selecting No.

Basic parameters for machine control are stored in the  Settings menu.

The factory settings are indicated by a tick ✓. A description of how to configure settings is provided after the overview.

## Menu structure

 Further choices

 Settings

 Time

 Clock format

 12 h

 24 h ✓

 Set time

 Date

 Date format

 DD/MM/YYYY ✓

 MM/DD/YYYY

 YYYY/MM/DD

 Set date

 Display brightness

 Volume

 Buzzer tones

 Keypad tone

 Key reaction

 Direct ✓

 Delayed

 Welcome tone

 On ✓

 Off

 Temperature unit

 °C ✓

 °F

## Time of day

The time of day is required for the display and the delay start, for example. The date format and the current time of day have to be set.

There is no automatic adjustment between daylight savings and standard time. You need to make this adjustment yourself as necessary.

### Selecting the time of day format

The menu is saved under the following input path.

Further choices

Settings

Time

Clock format

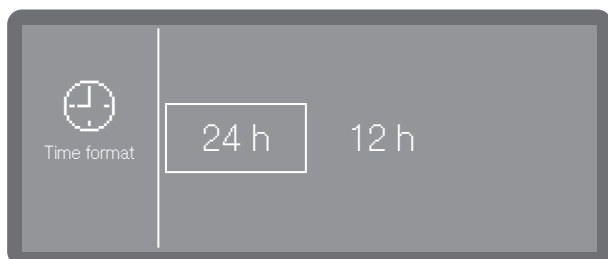

- 24 h

Time of day display in 24-hour format.

- 12 h

Time of day display in 12-hour format (am/pm).

■ Tap to select a format.

## Set the time of day

To set the format for the time of day:

The menu is saved under the following input path.

Further choices

Settings

Time

Set time

The time of day is set in the set time of day format.

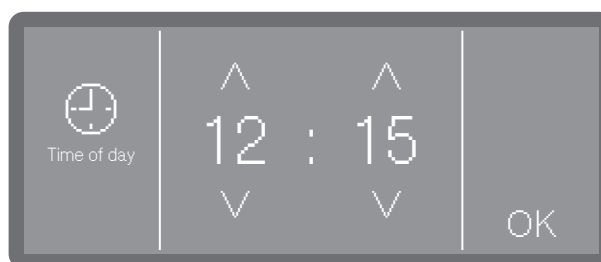

■ Use the ^ (higher) and v (lower) arrow buttons to set the time of day and confirm your selection by pressing OK.

## Date

The date format and the current date have to be set.

### Select the date format

The menu is saved under the following input path.

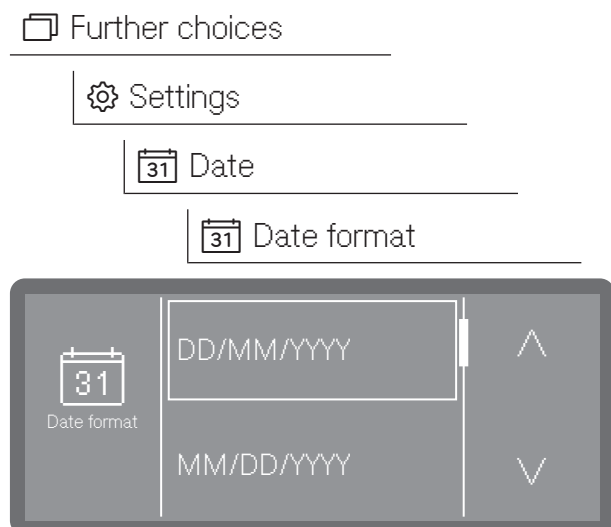

- DD is the day (D = day)
- MM is the month (M = month)
- YYYY is the year (Y = year)
- Scroll to the format you want using the  $\wedge$  and  $\vee$  arrow buttons and select it by tapping on it.

### Set the date

The menu is saved under the following input path.

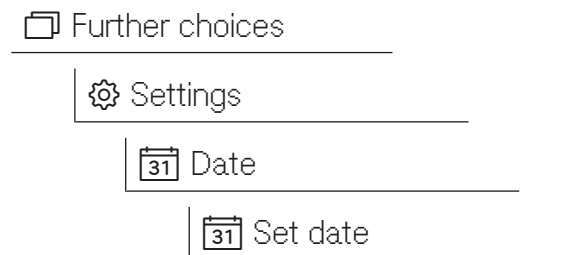

- Use the  $\wedge$  and  $\vee$  arrow buttons to set the year.

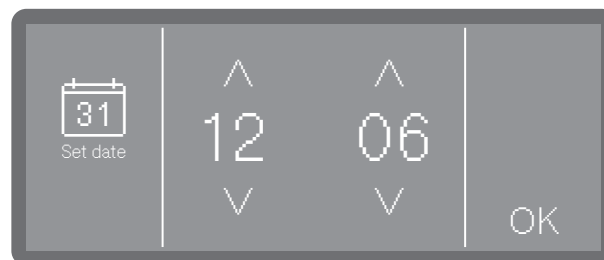

- Use the  $\wedge$  and  $\vee$  arrow buttons to set the day and the month.
- Press OK to save the setting.

### Display brightness

You can also set the brightness of the display.

The menu is saved under the following input path.

📁 Further choices

⚙️ Settings

🔆 Display brightness

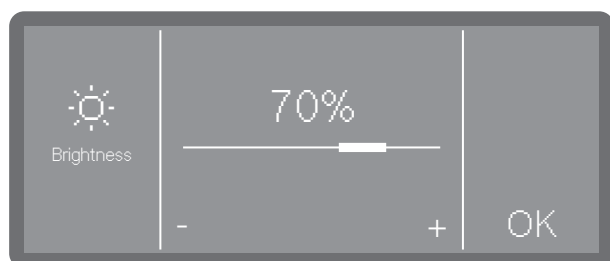

- Adjust the brightness of the display by tapping the - symbol (darker) and + symbol (brighter) and save the setting by pressing OK.

### Volume

An acoustic signal transmitter is integrated in the control panel, which can provide acoustic feedback in the following situations:

- Keypad tone when operating the buttons
- Buzzer tones at the end of a programme or for system messages (notifications)

The menu is saved under the following input path.

📁 Further choices

⚙️ Settings

🔊 Volume

The volume for the Keypad tone and the Buzzer tones is always set in the same way.

- Select one of the options Keypad tone or Buzzer tones.

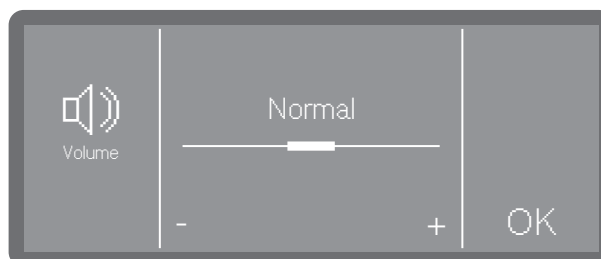

- Set the volume by tapping the - symbol (quieter) and + symbol (louder). In the lowest setting, the sound is switched off and can be switched on again if required by selecting On (displayed instead of the + symbol).
- Press OK to save the setting

## Button reaction

The button fields on the display can be configured to have a delayed reaction and to only react when the button field is pressed for a longer time. This can prevent the buttons from being triggered accidentally.

The menu is saved under the following input path.

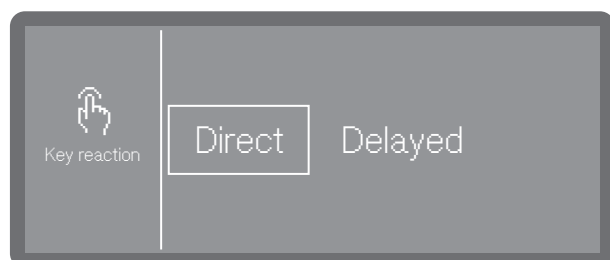
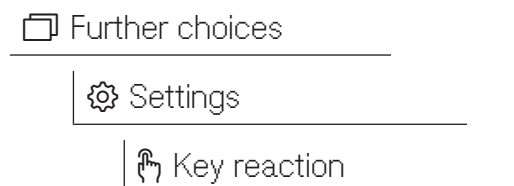

- Direct

The buttons react immediately to being pressed.

- Delayed

The buttons react with a delay when they are pressed and must be pressed for longer before they react.

■ Select an option.

## Welcome tone

There is a brief melody when the machine is switched on and off. You can use this option to switch this melody off and back on again.

The menu is saved under the following input path.

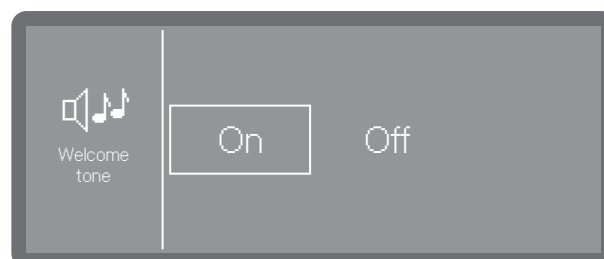
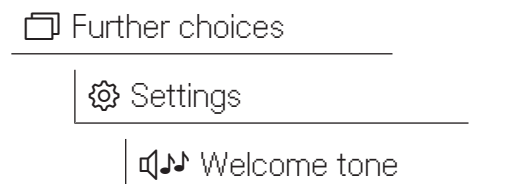

- On

A welcome melody is played when the machine is switched on.

- Off

The melody is switched off.

■ Select an option.

### Temperature unit

The temperature can be shown on the display in °C (degrees Celsius) or °F (degrees Fahrenheit).

The menu is saved under the following input path.

 Further choices

 Settings

 Temperature unit



- °C

Temperature display in Celsius.

- °F

Temperature display in Fahrenheit.

■ Tap to select the option you want.



The  Further settings menu incorporates all administrative processes and settings.

Access to the  Further settings menu is protected by a PIN code.

You must enter the correct PIN code to open the menu.

The factory settings are indicated by a tick ✓. A description of how to configure settings is provided after the overview.

### Menu structure

 Further choices

 Extended settings

 Programme lock filter

 On

 Off ✓

 Standby/Off

 Standby after 10 min

 Off after 10 min

 Log book

 Water

 Consumption cold water l

 Consumption hot water l

 Liquid clean. agent

 Rinse aid

 Operating hours

 Programme cycles

 Service interval

 Release programmes

 All programmes ✓

 Selection

☆ Set favourites

 Configure programmes

 Cleaning temperature

 Main wash holding time

 Final rinse temperature

 Final rinse holding time

 Increased water quantity

 Interim rinse

 On

 Off ✓

 Reset

 Dispensing systems

 Cleaning agent door

 Clean. agent canister

 Dispens. concentration

 Deactivate ✓

 Name ändern

\* Rinse aid door

\* Refill indicator

\* On ✓

\* Off

\* Dispens. concentration

## Further settings

---

 Rinse aid canister

 Dispens. concentration

 Deactivate ✓

 Cycles until empty

 Water hardness

 3,4 mmol/l (14° dh) ✓

 Cycles bef. reactivation

 1

 Memory

 On ✓

 Off

 PIN code

 Change PIN code

 Release further settings?

 Network/WiFi

 Set up

 Via WPS

 Via Soft AP

 Activate

 Deactivate

 Connection status

 Set up again

 Reset

 RemoteUpdate

 On

 Off ✓

 Dealer

 Demo mode

 On

 Off ✓

 Software version

 1-SBAE ID XXXX

 2-EL ID XXXX

 3-EFU ID XXXX

 5-LG ID XXXX

 Factory default

 Programme settings  
only

 All settings

 § Legal information

## Filter programme lock

The filter combination in the wash cabinet filters coarse dirt particles out of the wash water. If dirt particles enter the circulation system, they may clog the spray arms, valves, etc.

It is possible to stop the programme from starting if the micro-fine filter has been inserted incorrectly or is missing.

The menu is saved under the following input path.

📁 Further choices

⚙️ Extended settings

🌀 Programme lock filter

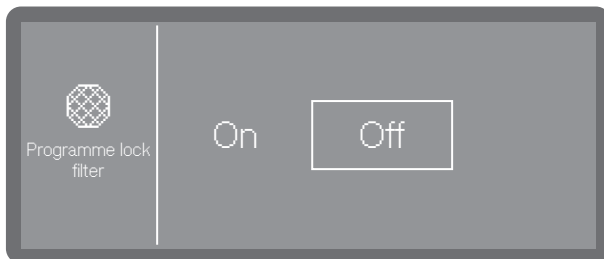

- On

Programmes are prevented from starting if the micro-fine filter has been inserted incorrectly or is missing.

A programme can only be started when the micro-fine filter is inserted correctly.

- Off

Programmes can be started regardless of the status of the micro-fine filter. A confirmation prompt is displayed, which must be confirmed if the micro-fine filter is not inserted correctly.

■ Select an option.

## Standby/Off

If the dishwasher has not been used for 10 minutes, it can be set to standby or switched off automatically.

In standby mode, the dishwasher remains switched on and the *Start/Stop* button flashes. The dishwasher can be reactivated by pressing the *Start/Stop* button, touching the display or opening the door.

After automatic switch-off, the dishwasher is switched off and can be switched on again by pressing the ⏻ button.

The menu is saved under the following input path.

📁 Further choices

⚙️ Extended settings

⏻ Standby/Off

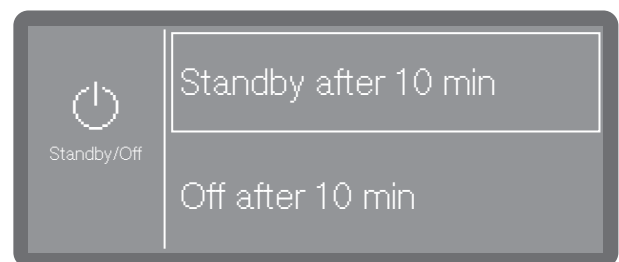

- Standby/Off

Switch to standby mode after 10 minutes

- Off after 10 min

Switch off after 10 minutes.

■ Select an option.

## Further settings

### Log book

The consumption data for water and process chemicals as well as the operating hours and programme sequences are logged in the log book. The entire life cycle of the machine is recorded.

The Miele Customer Service Department can also use the log book to calculate a recommendation for service intervals.

The menu is saved under the following input path.

 Further choices

 Extended settings

 Log book

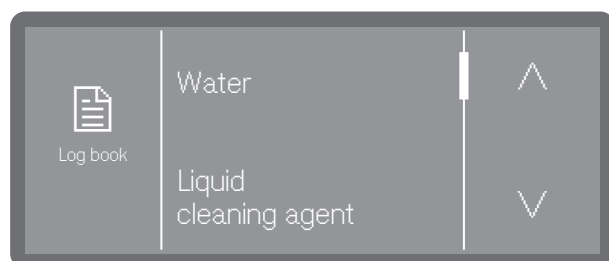

- Water

Display of water consumption in litres (l)  
If there are several water connections (depending on the model), the consumption is displayed according to the water type.

- Liquid cleaning agent

Consumption of liquid cleaning agent in litres (l)

- Rinsing agent

Consumption of rinsing agent in litres (l)

- Operating hours

Number of operating hours

- Programme sequences

Total of all programme sequences.  
The display can be broken down by programme.

- Service interval

Reminder about the next service. The date of the next service is entered by the Miele Customer Service Department.

- Scroll to the option you want using the ^ and v arrow buttons and select it by tapping on it.

The values in the log book cannot be changed.

- Press the ↵ button to exit the menu.

## Release programme

There is an option to block individual programmes. Blocked programmes are no longer available in the programme selection screen. This ensures, for example, that only programmes suitable for the load items are used.

The menu is saved under the following input path.

 Further choices

 Extended settings

 Release programmes

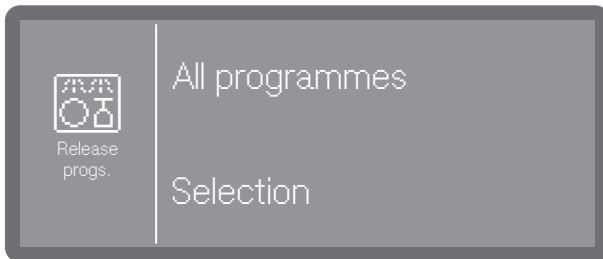

- All programmes  
All programmes are available for use.
- Selection  
A selection of programmes are available.

■ **Select an option.**

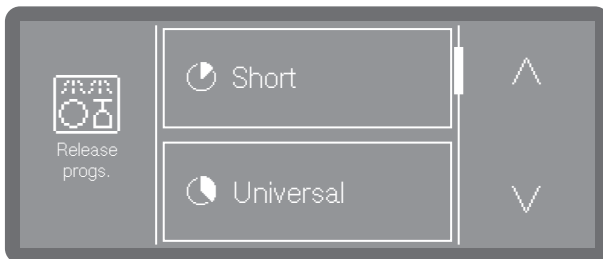

- Scroll through the programme list using the ^ and v arrow buttons and select the programmes that you want to make available to users. Multiple selection is possible. Activated programmes are highlighted by a frame.
- Press OK to save the selection

## Set favourites

Under Favourite programmes, you can define which programmes you want to be displayed on the start screen. 1 to 3

programmes can be selected. You can choose from all the programmes available under Approved programmes. At least 1 programme must be selected. Other favourites can be added or removed. It is possible to select a programme multiple times. It is displayed on the start screen the same number of times.

## Start screen layout

The layout of the start screen depends on the number of favourite programmes selected.

### 1 favourite programme

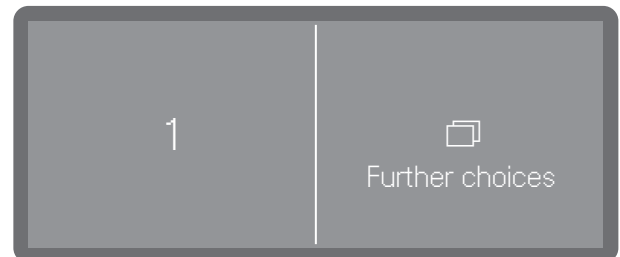

### 2 favourite programmes

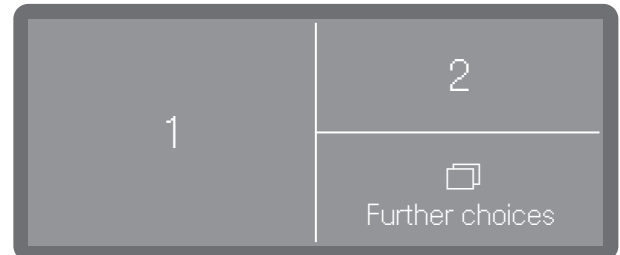

### 3 favourite programmes

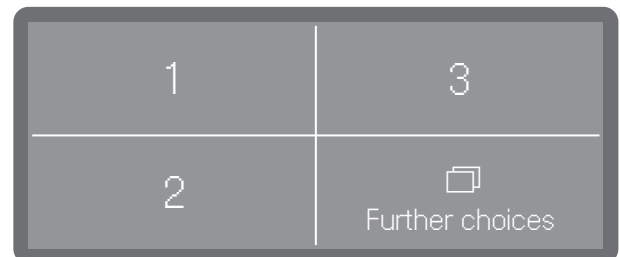

## Further settings

### Setting favourites

The menu is saved under the following input path.

 Further choices

 Extended settings

 Set favourites

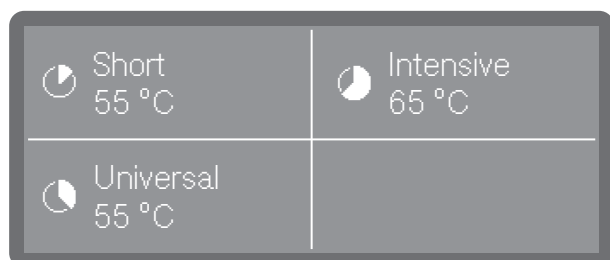

Three spaces for favourites are shown on the display.

- Select the favourites space you want to reassign by tapping on it.

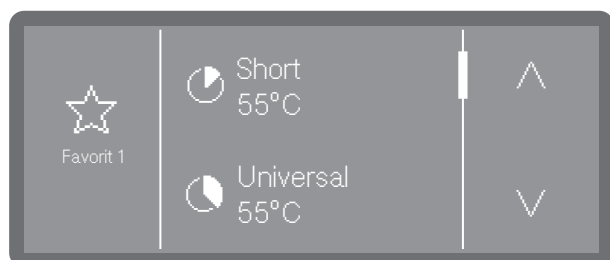

- Scroll through the programme list using the  $\wedge$  and  $\vee$  arrow buttons and select the programme that you want to appear in the selected favourites space.

The list of all programmes available under Approved programmes is then displayed. The list starts with an <empty> option. You can select this if you do not want the favourites space to be used.

- Select a programme to assign it to a favourites space. Or select <empty> if you want to leave the space unused.

### Programme parameters

The programme parameters should be adjusted to suit technical requirements and the load items.

Additional specialist knowledge about the machine and its processes is required to modify programme parameters and this should therefore be undertaken only by experienced users or by the Miele Customer Service Department.

- Start by selecting the programme you want to change.

### Selecting a programme

The menu is saved under the following input path.

 Further choices

 Extended settings

 Configure programmes

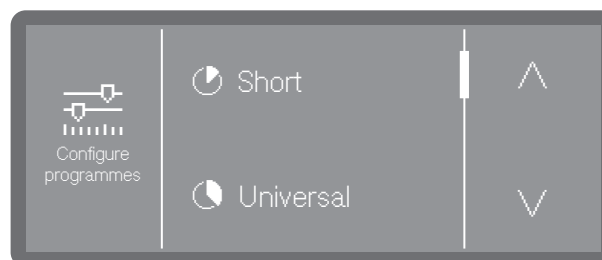

- Scroll through the programme list using the  $\wedge$  and  $\vee$  arrow buttons and select the programme that you want to change.

### Main wash temperature

The main wash temperature is reached by heating up the wash water. The temperature needs to be adjusted to the task.

Process chemicals are dispensed at a default dispensing temperature set ex-works.

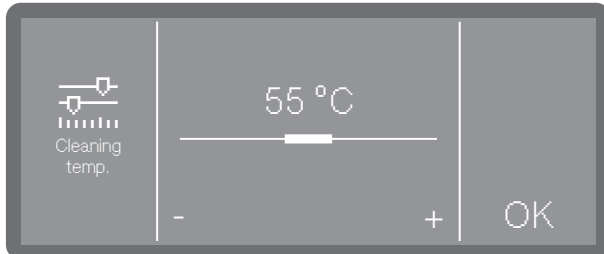

- Set the temperature by tapping the - symbol (lower) and + symbol (higher). The adjustment range varies depending on the model and programme.
- Press OK to save the setting

### Main wash holding time

The holding time is a period during which the temperature in the wash block is kept constant.

In the case of the Super Short programme, the holding time is entered in seconds and can be adjusted in 5-second increments.

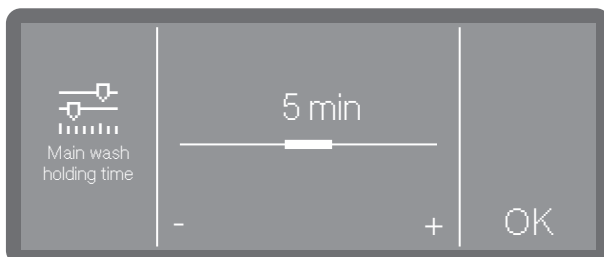

- Set the holding time by tapping the - symbol (lower) and + symbol (higher).
- Press OK to save the setting

### Final rinse temperature

The final rinse temperature is reached by heating up the wash water. The temperature needs to be adjusted to the task.

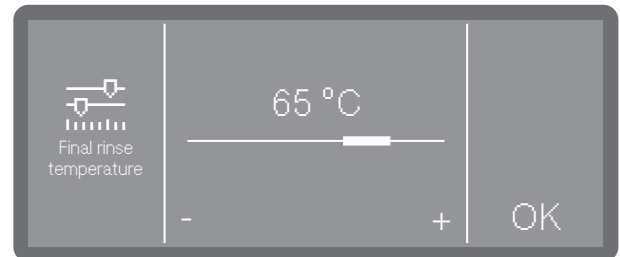

- Set the temperature by tapping the - symbol (lower) and + symbol (higher). The adjustment range varies depending on the model and programme.
- Press OK to save the setting

### Final rinse holding time

The holding time is a period during which the temperature in the wash block is kept constant.

In the case of the Super Short programme, the holding time is entered in seconds and can be adjusted in 5-second increments.

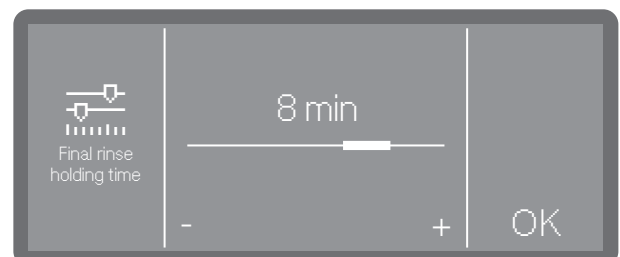

- Set the holding time by tapping the - symbol (lower) and + symbol (higher).
- Press OK to save the setting

## Further settings

### Increased water level

It is then advisable to increase the water level when a lot of water is absorbed due to the structure of the load items or when the type of soiling and the process chemicals used lead to excess foam development. The additional volume of water depends on the type of basket or mobile unit used, the type of soiling and the load items.

If slightly soiled load items which absorb a little water are being reprocessed, the water level can be reset to the factory default setting to save water and energy.

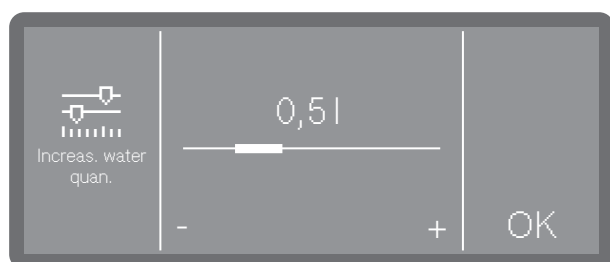

- Set the additional volume of water by tapping the - symbol (lower) and + symbol (higher). In the lowest setting, the volume of water corresponds to the factory default setting.
- Press OK to save the setting

### Interim rinse

If required, an additional intermediate wash block can be activated for selected programmes.

You can find out which programmes support this function in the “Programme chart”.



- On
  - Activates the additional intermediate wash block for the selected programme.
- Off
  - Deactivates the additional intermediate wash block.
- Tap to select an option.

### Resetting parameters

You can reset individual programmes to the factory default settings. The programme parameters and changed programme names are reset.

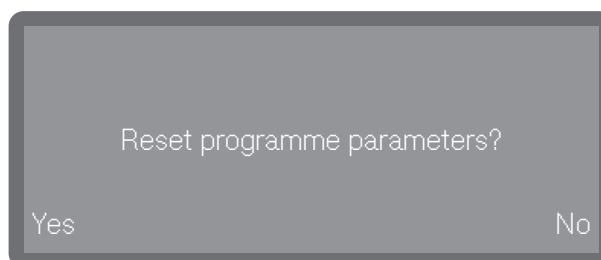

- Select Yes to reset the parameters and programme names to the factory default settings.
- Select No to cancel the process.



## Dispensing systems

The following menu allows you to activate, fill and rinse dispensing systems, to change their names if required and to set the dispensing concentration for all programmes.

Depending on the model, various dispensing systems are available for dispensing process chemicals.

Cleaning agent and rinsing agent can be dispensed either via a corresponding door dispenser (/// cleaning agent, \* rinsing agent) or via suction lances for liquid media from an external canister. It is not possible to activate both systems at the same time.

### Selecting a dispensing system

The menu is saved under the following input path.

 Further choices

 Extended settings

 Dispensing systems

 Cleaning agent door

 Clean. agent canister

 Rinse aid door

 Rinse aid canister \*)

\*) Depending on the model

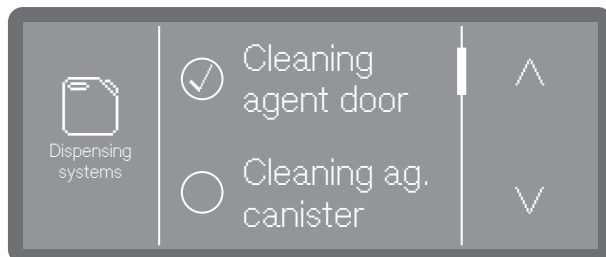

Only the available dispensing systems are displayed.

- Select a dispensing system.

## Door dispenser

 Cleaning agent door

This selection is only available if the corresponding dispensing system is present (depending on the model).

One of the following messages is displayed if you have selected Cleaning agent door.

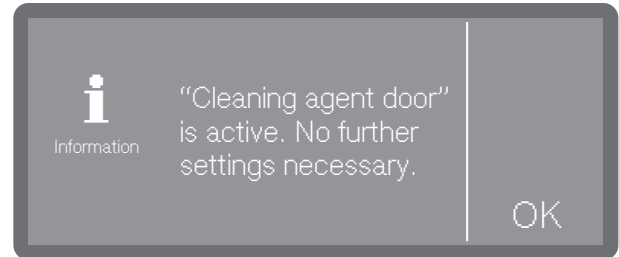

- Door dispenser activated

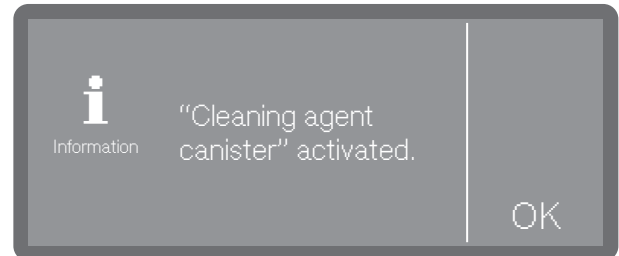

- Dispensing from the canister activated.

- No further settings are possible. Confirm the message by pressing OK.

If you want to change dispensing to the powder dispenser, select "Cleaning agent door" and activate it, or select the Clean. agent canister option and deactivate dispensing.

## Further settings

### Rinse aid door

This selection is only available if the corresponding dispensing system is present (depending on the model).

#### Refill indicator

The refill indicator indicates a lack of rinsing agent in the door dispenser. If you want to stop dispensing rinsing agent via the door dispenser, you need to switch off the refill indicator.

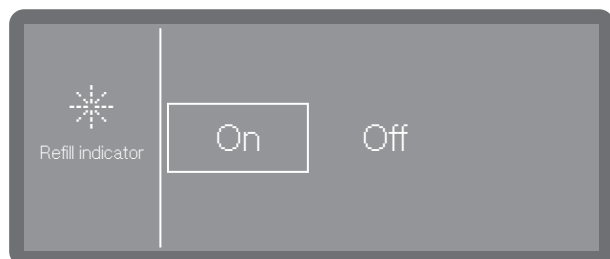

#### - On

The display indicates a lack of rinsing agent in the door dispenser.

#### - Off

The display does not indicate a lack of rinsing agent.

#### ■ Select an option.

### Activating dispensing from the canister

Dispensing from the door dispensers is preset ex-works.  
For DOS dishwashers, integrated liquid dispensing is preset.



To activate dispensing of liquid process chemicals from external canisters, you must proceed as follows.

#### ■ Start by selecting a dispensing system.

This selection is only available if the corresponding dispensing system is present.

 Clean. agent canister

 Rinse aid canister

If a rinsing agent door dispenser  or a powder dispenser  is present and activated (depending on the model), when you select Clean. agent canister or Rinse aid canister, you will first be asked if you want to switch to dispensing from the canister. There is no query if dispensing from the canister is already activated.

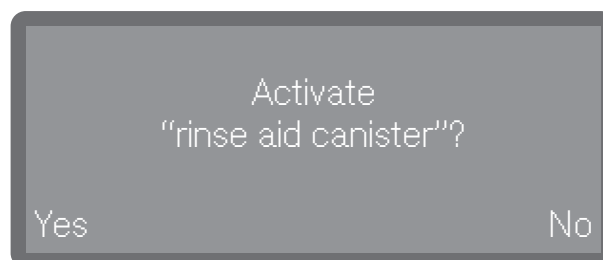
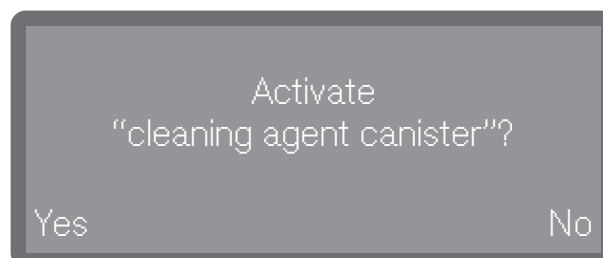

#### ■ Select OK to change dispensing to liquid dispensing from the canister. This change will take place immediately.

Or:

#### ■ If you do not want to change the setting, press the button.

### Deactivating dispensing from the canister

You can subsequently switch dispensing from the canisters to the door dispensers or deactivate it completely.

- Start by selecting a dispensing system.

This selection is only available if the corresponding dispensing system is present.

 Clean. agent canister

 Rinse aid canister

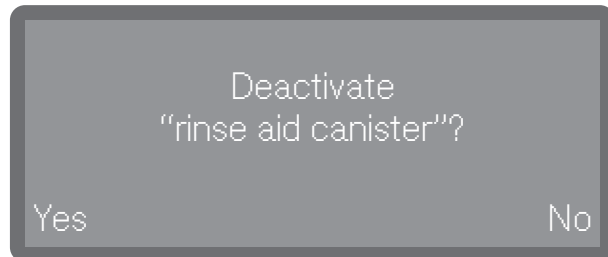
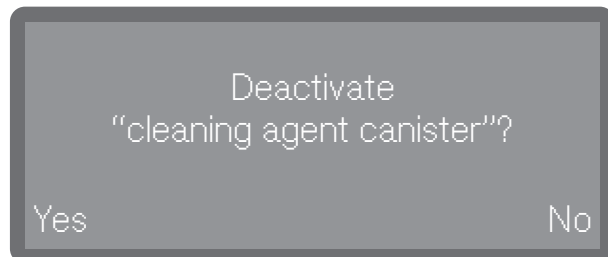

- Select OK to deactivate dispensing from the canister. This change will take place immediately.
- If you do not want to change the setting, press the ↩ button.

### Dispensing concentration

The dispensing concentration for liquid process chemicals is set in the same way for all dispensing systems. The setting applies to all programmes.

This selection is only available if the corresponding dispensing system is present.

 Rinse aid door

 Clean. agent canister

 Rinse aid canister

- Start by selecting a dispensing system.

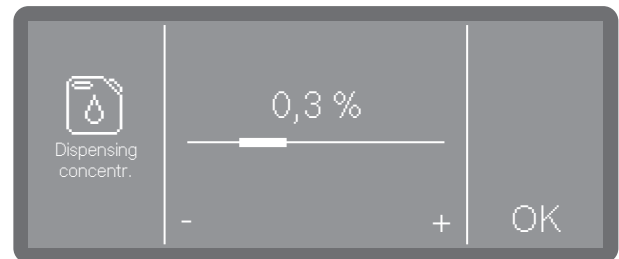

- Set the dispensing concentration by tapping the - symbol (lower) and + symbol (higher).
- Press OK to save the setting.

### Filling dispensing paths

See  Machine functions

### Rinsing dispensing paths

See  Machine functions

## Further settings

### Cycles until empty

This function is only available on machines with fill level detection.

When dispensing liquid process chemicals from external canisters, the fill level in the canister is monitored. You can use the following function to set the number of programme sequences (cycles) from which you want to be warned about the imminently empty canisters. The message is displayed after switching on the machine and before every programme start.

You can set the number of cycles from 0–150 cycles; at 0, a notification is only issued when the canisters are empty.

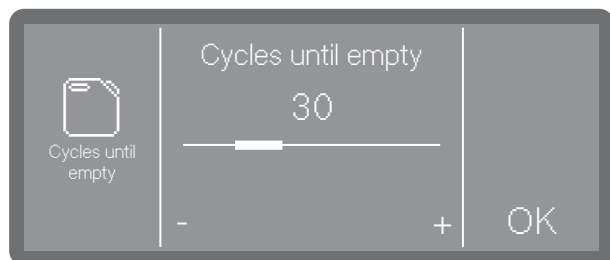

- Set the number of cycles by tapping the - symbol (lower) and + symbol (higher).
- Press OK to save the setting.

### Water hardness

The water hardness setting is described in “Filling the salt container”.

### Reactivation notification

In order to plan wash phases more effectively, you can have the remaining number of wash cycles before the next reactivation displayed as a notification. When the set number of cycles before the next reactivation has been reached, a notification is displayed after each completed programme.

You can set the number of cycles from 0–20 cycles; at 0, no notification is displayed.

The menu is saved under the following input path.

 Further choices

 Extended settings

 Cycles bef. reactivation

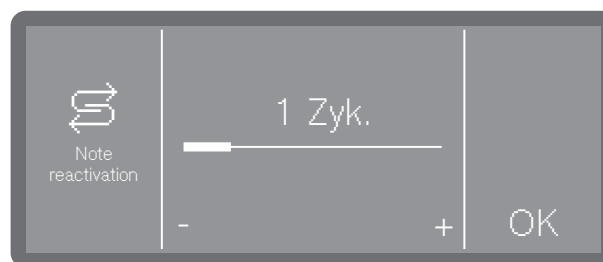

- Set the number of cycles by tapping the - symbol (lower) and + symbol (higher).
- Press OK to save the setting.

## Memory

If you are always using the same programme in a continuous sequence, you can use the memory function. This automatically suggests the most recently selected programme so that you can start the programme immediately after loading. The programme selection screen is therefore not displayed, but it is still available.

The menu is saved under the following input path.

 Further choices

 Extended settings

 Memory

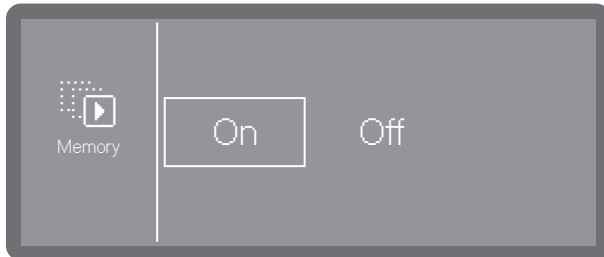

- On

The most recently selected programme is pre-selected before the next programme starts.

- Off

The programmes need to be selected via the programme selection screen.

- Select an option.

## PIN code

Access to relevant system settings and machine functions that require advanced knowledge of the machine and its processes can be protected by PIN codes. A PIN code consists of 3 numbers from 0–9 in any order.

The factory-assigned PIN code is 800.

 If a PIN code is lost, a new code must be issued by the Miele Customer Service Department.

### Entering the PIN code



- Use the  $\wedge$  and  $\vee$  arrow buttons to set relevant numerical values.
- Confirm each digit individually by pressing OK.

There are 3 boxes above the numerical value. Once a number has been entered and confirmed by pressing OK, the box is filled. This allows you to keep track of which number of the PIN code you are currently entering.

You can cancel the process at any time by pressing the  $\curvearrowright$  button.

If the PIN code was entered correctly, the protected area is made available for further use.

If it is entered incorrectly, a corresponding message is displayed and the process is cancelled.

## Further settings

### Blocking further settings or making them available

Access to the menu can be protected by a PIN code or can be made available to all users. A new code can also be assigned.

The menu is saved under the following input path.

 Further choices

 Extended settings

 PIN code

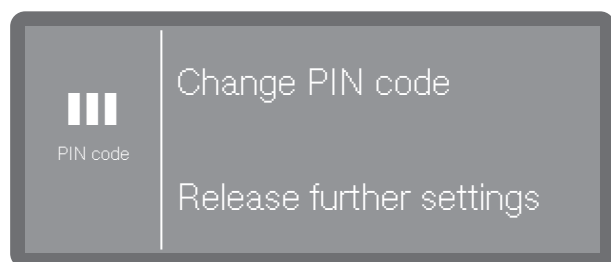

- Change PIN code

Assign a new PIN code (see “Changing a PIN code”).

- Release further settings.

The  Extended settings menu is available to all users.

■ Select an option.

### Changing a PIN code

When a new PIN code is entered, the old PIN code is overwritten and is permanently deleted. It is therefore not possible to reinstate the old code.

If a PIN code is lost, a new code must be issued by the Miele Customer Service Department.

Assign a new PIN code by selecting the Change PIN code option in the menu.

■ Follow the instructions on the display and start by entering the current PIN code.



■ Use the  $\wedge$  and  $\vee$  arrow buttons to set relevant numerical values.

■ Confirm each digit individually by pressing OK.

There are 3 boxes above the numerical value. Once a number has been entered and confirmed by pressing OK, the box is filled. This allows you to keep track of which number of the PIN code you are currently entering.

You can cancel the process at any time by pressing the  $\leftarrow$  button.

■ Then enter the new code.

■ Confirm the new PIN code by entering it again.

If both entries match, the old PIN code is replaced by the new code.

If the entries do not match, a corresponding message is shown on the display and the old PIN code remains in use.

## Networking/WiFi

Your dishwasher is equipped with an integrated WiFi module.

You can connect your dishwasher to your local network in order to use digital solutions from Miele.

An overview of these digital solutions is available on the webpage:  
<https://www.miele.co.uk/p/>

Once the dishwasher is connected to your local network, more menu options are added to the “Further settings” and “Networking/WiFi” menu.

Check the settings of your WiFi router, especially when operating several machines in the WiFi network.

Make sure that your WiFi network signal is strong enough at the installation site of your dishwasher.  
 Place the dishwasher and the router at a suitable distance from each other.

The menu is saved under the following input path.

 Further choices

 Extended settings

 Network/WiFi

### WiFi setup

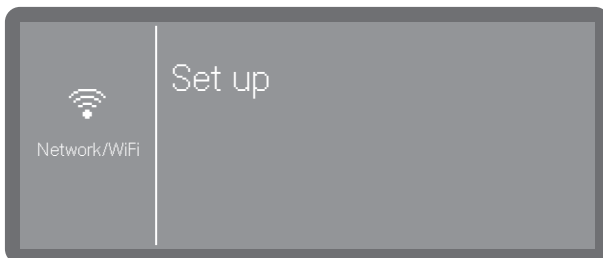

- Select the Set up menu option.

You can connect your dishwasher to your network using Via WPS or Via Soft AP.

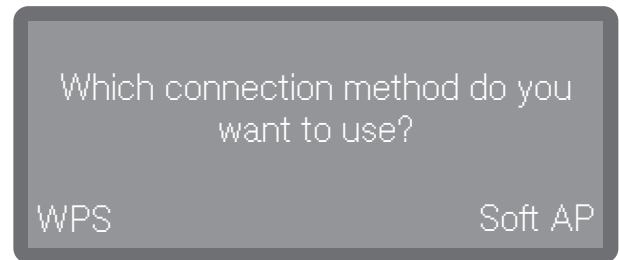

### Connection via WPS

You can connect your dishwasher to your WiFi network using WPS (Wi-Fi Protected Setup).

Your WiFi router must support WPS.

- When asked Which connection method do you want to use?, **select WPS.**

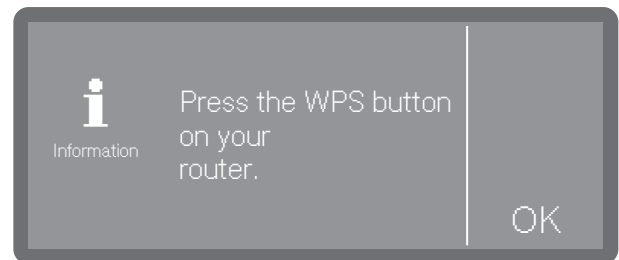

- When Press the WPS button on your router. **appears on the display, activate the WPS function on your router within 2 minutes.**
- Once the connection has been established, **Connection successfully established will appear on the display. Confirm the message with OK.**

If the connection fails, you have probably not activated WPS on your router quickly enough. Repeat the steps above.

## Further settings

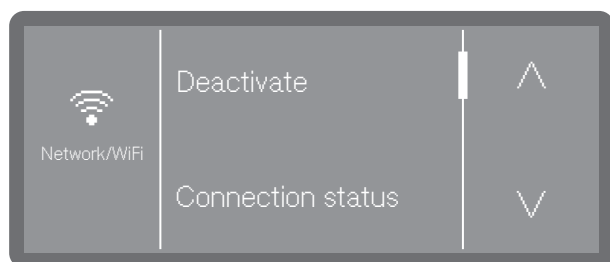

### - Deactivate

The WiFi connection is deactivated but the connection options are retained. The WiFi connection can be reactivated without having to repeat the connection process.

### - Connection status

Displays the IP address and the connection status of the WiFi connection.

### - New set up

Menu option for setting up a new WiFi connection.

### - Reset

Resets the WiFi connection. The connection options are lost and need to be set up again.

## Soft AP

If Connection via WPS is not possible, you can connect the dishwasher to your local network Via Soft AP.

A Soft-AP (Software-enabled Access Point) is a wireless access point provided by your dishwasher that can be used by other wireless machines in the vicinity. With Soft-AP, the dishwasher is not connected to the Internet. A Soft AP is only used to connect two machines locally via WiFi.

## Connecting via Soft-AP

You can connect your dishwasher to your WiFi network via a Soft-AP (Software Enabled Access Point).

- When asked Which connection method do you want to use?, select Soft AP.

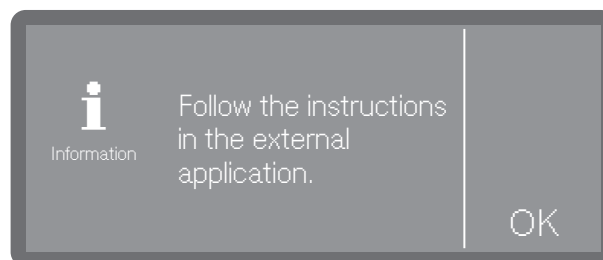

- Confirm the message by pressing **OK** and follow the instructions in the external application.

Waiting for connection will appear on the display. This message remains active for approx. 10 minutes after selection and is then closed.

- Once the connection has been established, Connection successfully established will appear on the display.
- Confirm the message with **OK**.



## RemoteUpdate

This menu option only appears if the dishwasher has been integrated into the WiFi network.

When a new version of the dishwasher control system is available, you can decide whether or not to automatically update it.

The menu is saved under the following input path.

 Further choices

 Extended settings

 RemoteUpdate

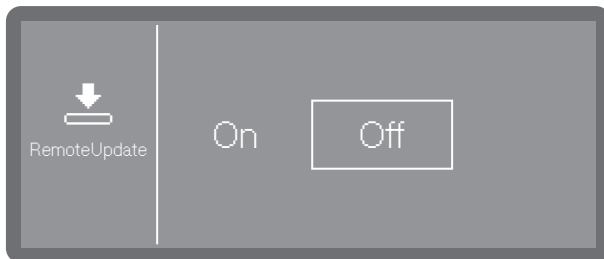

- On

The updates are displayed and can be downloaded.

- Off

Updates are ignored.

■ Select an option.

## Showroom programme

For demonstration purposes only.

The dishwasher is equipped with a demo mode for showroom use.

The menu is saved under the following input path.

 Further choices

 Extended settings

 Dealer

## Software version

This displays the versions of the individual software units.

The menu is saved under the following input path.

 Further choices

 Extended settings

 Software version

The relevant software version numbers appear on the display. No settings are possible.

## Further settings

### Factory defaults

If necessary, the modified programme parameters or all dishwasher parameters can be reset to the factory default settings.

The factory default settings should only be restored in consultation with the Customer Service Department.

The menu is saved under the following input path.

 Further choices

 Extended settings

 Factory default

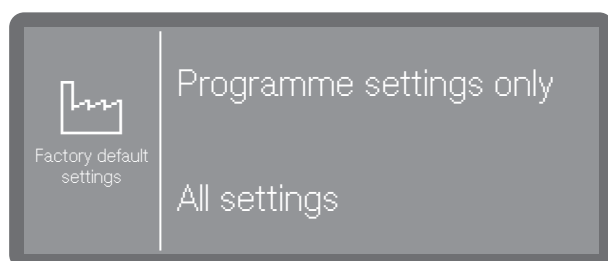

- Programme settings only

The changes to the programme settings are reset to the factory default settings.

- All settings

All changes are reset to the factory default settings.

■ Select an option.

Depending on the option you have chosen, you will be asked whether Programme settings only or All settings should be reset.

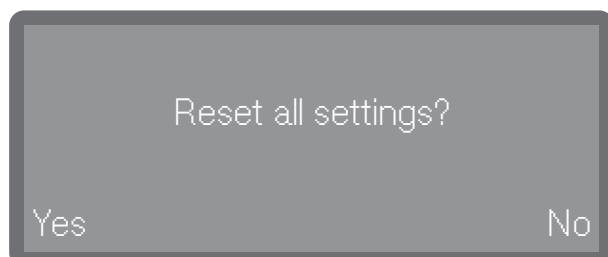
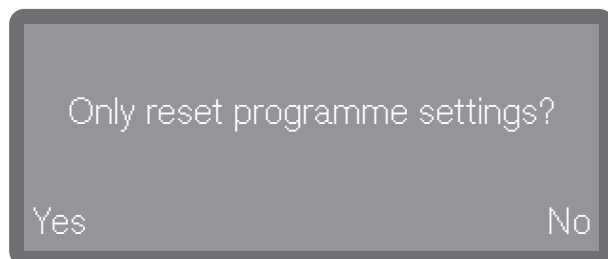

■ Selecting Yes resets the programme settings or all settings, depending on the option chosen.

Or:

■ If you do not want to reset, select No.

### Legal information

This menu contains legal information such as the imprint, information on data protection and the terms of use.

The menu is saved under the following input path.

 Further choices

 Extended settings

 Legal information

The information appears on the display. No settings are possible.

### Periodic checks

To prolong the service life of the dishwasher, maintenance should be carried out **at least once a year** by the Miele Customer Service Department.

This maintenance will cover the following:

- Electrical safety according to national regulations (VDE 0701/0702 in Germany)
- Door mechanism and door seal
- Any screw connections and connectors in the wash cabinet
- Water inlet and drainage
- Internal and external dispensing systems
- Spray arms
- Filter combination
- Sump including drain pump and non-return valve
- All baskets and inserts

The following operational tests will be carried out as part of the maintenance:

- A programme will be run as a test run
- Seals will be tested for water tightness
- All relevant measuring systems will be safety tested, including fault displays
- Safety features

 Soiling alters the surface.

Soiling that is left too long might become impossible to remove and could cause the surfaces to alter or discolour.

Remove any soiling from the control panel and from the machine front straight away where possible.

 All surfaces are susceptible to scratching.

Contact with unsuitable cleaning agents can alter or discolour all surfaces.

Only use suitable cleaning agents.

### Cleaning the control panel

- Clean the control panel with a clean sponge and a solution of warm water and washing-up liquid, or with a clean, damp microfibre cloth. Then dry the control panel with a soft cloth.

 Damage to the user interface.

Abrasive cleaning agents can damage the user interface.

Do not use abrasive cleaning agents!

## Cleaning and care

---

### Cleaning the machine front

- To clean the stainless steel front, use a damp cloth with a solution of washing-up liquid and hot water, or with a non-abrasive cleaning agent for use on stainless steel.

To help prevent re-soiling (fingerprints, etc.), a suitable stainless steel care product can be used after cleaning.

 **Damage to the surfaces.**  
Cleaning agents containing ammonia and thinners can damage surfaces.  
Avoid these products when cleaning.

 **Damage to the dishwasher caused by ingress of water.**  
Do not clean the dishwasher or its immediate vicinity with a hose or a pressure washer.  
Make sure that water does not enter the dishwasher when it is being cleaned.

### Cleaning the wash cabinet

The wash cabinet is largely self-cleaning, provided that the correct amount of cleaning agent is always used.

If, despite this, limescale or grease deposits accumulate in the cabinet, these can be removed with a proprietary dishwasher cleaner (available from Miele).

### Cleaning the door and the door seal

- Wipe the door seal and the area beneath the door regularly with a damp cloth to remove food deposits.
- Wipe off any food or drink residues that may have dripped onto the sides and hinges of the dishwasher door.
- With freestanding machines that have a plinth panel, remove spillages of food and drink from the channel that runs below the door.

 **Risk of cutting yourself.**  
There is a risk of cutting yourself.  
Be cautious of sharp edges when cleaning.

These surfaces are outside the wash cabinet. Water from the spray jets does not reach them. As a result, mould can develop here.

## Cleaning filters in the wash cabinet

The filter combination in the base of the wash cabinet retains coarse soiling from the suds solution. It prevents soiling from entering the circulation system and causing blockages in the spray arms.

When Programme lock filter is activated, it is not possible to use the dishwasher without a micro-fine filter!

If the micro-fine filter is not inserted properly, it is not possible to start a programme and the following fault message **Programme lock filter** appears on the display.

Insert the micro-fine filter properly and make sure it is positioned correctly (see "Cleaning and care, Cleaning filters in the wash cabinet").

The filter combination must be checked regularly and cleaned when necessary.

⚠ Risk of injury from glass splinters. Glass splinters cannot always be detected in the filter straight away. Take extra care when cleaning the filters.

## Cleaning the coarse filter

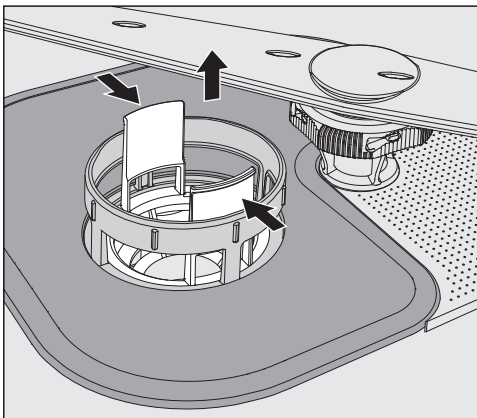

- Press the catches towards each other and remove the coarse filter.
- Rinse the filter thoroughly under running water. If necessary, use a soft cleaning brush to remove soiling.
- Replace the filter, making sure it engages correctly.

## Cleaning the flat and micro-fine filters

- Remove the coarse filter as described before.

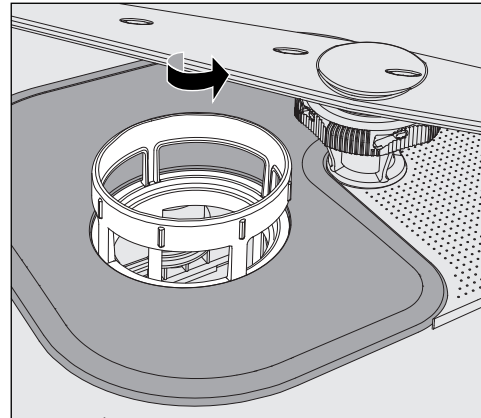

- Grasp the micro-fine filter by the upper rim and turn it in the direction of the arrow to release it. Then lift it out.

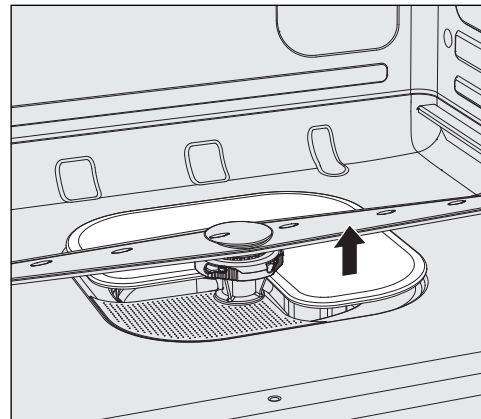

- Remove the flat filter.
- Rinse the filters under running water. If necessary, use a soft washing-up brush to remove soiling.

Replace the filter combination in the reverse order, turning the micro-fine filter to the left to re-engage it.

The flat filter must lie flat in the bottom of the wash cabinet.

The spray arms may get blocked if the filters are not replaced correctly. Ensure that the filters are positioned correctly.

## Cleaning and care

### Cleaning the spray arms

The dishwasher has three different spray arms.

Particles of food can get stuck in the spray arm nozzles and bearings. The spray arms should therefore be checked and cleaned regularly.

- Switch the dishwasher off.
- Pull the **upper spray arm** downwards to remove it.

The middle and bottom spray arms are secured with a bayonet fitting.

The bayonet fitting on the lower spray arm is coloured yellow so that it cannot be mistaken for the fitting on the middle spray arm.

To release the bayonet fitting, proceed as follows:

- Using the knurled nut, turn the **middle spray arm** to the left as far as it will go and then pull the spray arm downwards to remove it.
- Remove the lower basket.

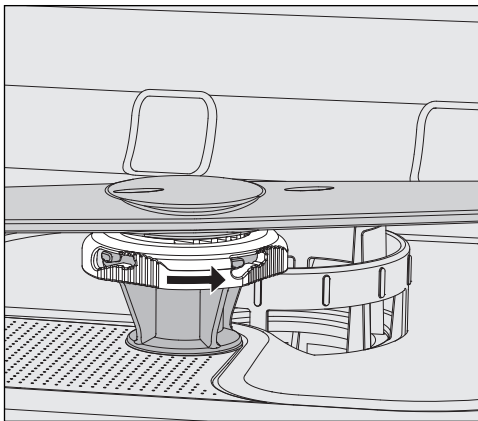

- Using the knurled nut, turn the **lower spray arm** in the direction of the arrow as far as it will go and then pull the spray arm upwards to remove it.

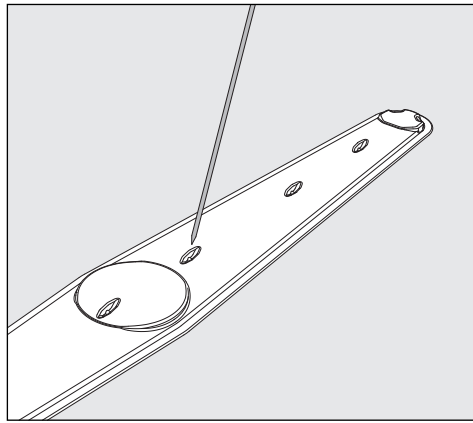

- Use a pointed object to push food particles into the spray arm nozzles.
- Rinse the spray arms thoroughly under running water.

Replace the spray arms and check that they rotate freely.

Make sure that the spray arm with the yellow bayonet fitting is fitted in the bottom of the wash cabinet.

With the aid of the following guide, most minor problems that can occur during daily operation can be corrected without contacting Miele. You can save time and money in many cases, as you do not need to call the Miele Customer Service Department.

The following guide should help you to find the reason for a malfunction or fault and to correct it. You should, however, note the following:

 Danger due to incorrect repairs.

Incorrect repairs can cause considerable danger to users.

Repairs must only be carried out by the Miele Customer Service Department, an authorised Miele dealer or a suitably qualified specialist.

### Technical problems

Problem	Cause and remedy
<b>The display remains dark and the Start/Stop display light is not flashing after the dishwasher has been switched on with the  button.</b>	The machine is not plugged in. ■ Insert the plug and switch on at the socket.
	The circuit breaker has tripped. ■ Reset the trip switch in the circuit breaker box (see data plate for minimum protection rating).
<b>The dishwasher stops during a programme</b>	The circuit breaker has tripped. ■ Reset the trip switch in the circuit breaker box (see data plate for minimum protection rating). ■ If the circuit breaker trips again, contact the Miele Customer Service Department.
<b>Power failure during operation</b>	If a temporary power failure occurs during a programme sequence, no measures are required. The programme will continue after the interruption. If the temperature in the wash cabinet drops below the minimum value required for the programme block during the power failure, the programme block is repeated.

## Problem solving guide

---

### Faults with water inlet or drainage



Problem	Cause and remedy
<b>One of the following fault messages or notifications appears on the display:</b>	Before rectifying the problem: <ul style="list-style-type: none"><li data-bbox="549 322 1415 367">■ Switch the dishwasher off with the  button.</li></ul>
F404 Water inlet, cold too low: check water inlet. Open stopcock fully. Turn appliance off and on. Restart programme. If fault persists, contact customer service. Service phone: Serial number:	Water inlet fault. <ul style="list-style-type: none"><li data-bbox="549 456 1415 501">■ Open the stopcock fully.</li><li data-bbox="549 501 1415 546">■ Clean the water inlet filter (see “Cleaning and Care”).</li></ul>
F541 Water drainage: Turn appliance off and on. Start “Drain” programme. Clean filter combination and non-return valve. If fault persists, contact customer service. Service phone: Serial number:	Water drainage fault. There might be water in the wash cabinet. <ul style="list-style-type: none"><li data-bbox="549 770 1415 815">■ Clean the filter combination (see “Cleaning and care”).</li><li data-bbox="549 815 1415 860">■ Clean the drain pump, see “Problem solving guide”.</li><li data-bbox="549 860 1415 904">■ Clean the non-return valve (see “Problem solving guide”).</li><li data-bbox="549 904 1415 949">■ Remove any kinks or loops in the drain hose.</li></ul>



### Cancel with fault number

If a programme is cancelled and a fault number appears, e.g. Fault F XXX (where XXX represents a number), there could be a serious technical fault.

In the event of a programme being cancelled and a fault number being shown:

- Switch the dishwasher off with the  button.
- Wait approximately 10 seconds before switching the dishwasher on again with the  button.
- Start the previously selected programme again.

If the same fault message appears again:

- Make a note of the fault message.
- Switch the dishwasher off with the  button.
- Contact the Miele Customer Service Department.

Please also read the notes regarding the following fault numbers.



Problem	Cause and remedy
Fault F 404–405	<p>If Check water inlet appears on the display, the control system is checking the water intake approx. every 30 seconds. If, after three attempts, water is not getting into the dishwasher, one of these fault numbers will appear on the display and the programme will be cancelled.</p> <ul style="list-style-type: none"> <li>■ Open the stopcock fully.</li> <li>■ Switch the dishwasher off and back on again.</li> <li>■ Select the programme you want to use.</li> <li>■ Press the <i>Start/Stop</i> button.</li> </ul>
Fault F 407–408	<p>Water inlet fault. If the flow pressure is too low, one of these fault numbers will appear on the display and the programme will be cancelled.</p> <ul style="list-style-type: none"> <li>■ The flow pressure at the water connection is too low (see “Technical data”). Contact the Miele Customer Service Department for advice.</li> </ul>
Fault F 413–414	<p>Water inlet fault. If the flow pressure is too high, one of these fault numbers will appear on the display and the programme will be cancelled.</p> <ul style="list-style-type: none"> <li>■ The flow pressure at the water connection is too high (see “Technical data”). Contact the Miele Customer Service Department for advice.</li> </ul>
Fault F 492, 541	<p>The programme has not started properly. There might be water in the wash cabinet.</p> <ul style="list-style-type: none"> <li>■ Clean the filter combination (see “Cleaning and care”).</li> <li>■ Clean the non-return valve (see “Problem solving guide”).</li> </ul>

## Problem solving guide

---



Problem	Cause and remedy
Fault F 550	The waterproof system has reacted. <ul style="list-style-type: none"><li>■ Close the stopcock.</li><li>■ Call the Miele Customer Service Department.</li></ul>
Fault F 578	The peak-load negotiation has lasted longer than 2 hours. <ul style="list-style-type: none"><li>■ Have your electrical system and your energy management system tested by a specialist.</li></ul>

### Door

Problem	Cause and remedy
<b>The door opens again after being closed</b>	<p>If the door is closed with too much force, the comfort door locking mechanism will open it again.</p> <ul style="list-style-type: none"> <li>■ Guide the door into the door lock with less force.</li> </ul>
Hot wash cabinet: Risk of injury, take care when opening the door.	<p>The temperature in the wash cabinet is over 67 °C when the  button is pressed.</p> <div style="border: 1px solid black; padding: 5px; margin: 5px 0;"> <p> When the door is opened, hot steam and process chemicals can escape!</p> </div> <ul style="list-style-type: none"> <li>■ Open the door only when strictly necessary.</li> </ul>
F433 Door blocked: Remove blockage in door area. Turn appliance off and on.	<p>A protruding load item is obstructing the door.</p> <ul style="list-style-type: none"> <li>■ Arrange the load item so that it does not obstruct the door.</li> <li>■ Close the door.</li> </ul> <p>The comfort door lock is blocked.</p> <ul style="list-style-type: none"> <li>■ Try to open the door carefully (without using force) by pulling on the door handle.</li> </ul> <p>If the door is still blocked:</p> <ul style="list-style-type: none"> <li>■ Open the door using the emergency release.</li> <li>■ Close the door and try to open it again using the  button.</li> </ul> <p>If it is still blocked:</p> <ul style="list-style-type: none"> <li>■ Contact the Miele Customer Service Department.</li> </ul>
Anti-trap guard: To continue, open door.	<p>This is not a fault! The door is locked while the door locking mechanism retracts to the lock position.</p> <ul style="list-style-type: none"> <li>■ Open the door and wait until the door locking mechanism reaches its final position.</li> </ul>

# Problem solving guide

## General problems with the dishwasher

Problem	Cause and remedy
Programme completed successfully <b>has appeared on the display and you cannot select or start a programme.</b>	This is not a fault! <ul style="list-style-type: none"> <li>■ Open and close the door. The dishwasher must be switched on for this.</li> </ul>
<b>The dishwasher does not respond to any button. The indicator lights and the display are dark.</b>	The dishwasher is switched off after 10 minutes to save energy. <ul style="list-style-type: none"> <li>■ Press the  button to switch the dishwasher back on.</li> </ul>
<b>The display is dark and the Start/Stop button is flashing.</b>	The dishwasher is switched to standby mode after 10 minutes to save energy. <ul style="list-style-type: none"> <li>■ Press any button to exit standby mode.</li> </ul>
<b>The following fault message appears on the display before the programme starts:</b> Salt container lid: Check fit.	The salt container is not closed properly. <ul style="list-style-type: none"> <li>■ Close the container properly.</li> </ul> <p>Salt residues are preventing it from closing.</p> <ul style="list-style-type: none"> <li>■ Remove the salt residues from the refilling funnel, the lid and the seal. Do <b>not</b> use running water to rinse away salt residues as this can cause the container to overflow.</li> <li>■ Close the container properly.</li> </ul>
<b>The following fault message appears on the display:</b> F553 Salt container: Turn appliance off and on. Close flap in the door correctly. If fault persists contact customer service. Service phone: Serial number:	The salt container flap has sprung open during a programme. <div style="border: 1px solid gray; padding: 5px; margin: 5px 0;"> <p> When the door is opened, hot steam and process chemicals can escape!</p> </div> <ul style="list-style-type: none"> <li>■ Open the door and close the container flap.</li> </ul>
<b>The cleaning agent dispenser lid cannot be closed properly.</b>	Residual cleaning agent is blocking the catch. <ul style="list-style-type: none"> <li>■ Remove the cleaning agent.</li> </ul>
<b>At the end of a programme there is a film of moisture on the inside of the door and the interior cabinet walls.</b>	This is not a fault. It is caused by the drying system. The moisture will dissipate after a short while.

Problem	Cause and remedy
<b>Water remains in the wash cabinet at the end of a programme. (This does not apply to the Super short programme)</b>	Before rectifying the problem: ■ Switch the dishwasher off with the  button.
	The filter combination in the wash cabinet is clogged. ■ Clean the filter combination (see “Cleaning and care”).
	The drain pump or the non-return valve is blocked. ■ Clean the drain pump or the non-return valve (see “Problem solving guide”).
	The drain hose is kinked. ■ Remove any kinks from the drain hose.
	The on-site drain siphon is blocked. ■ Check and clean the drain siphon.
Peak load cut-out	This is not a fault! Your energy management system has detected a peak load in the energy supply. Some components in the dishwasher stop operating for the duration of the peak-load negotiation.
Temperature compensation after opened door: Programme will continue in min	This is not a fault! If the door is opened during a programme sequence and the temperature in the wash cabinet is above 60 °C, pressure equalisation takes place once the door is closed.

## Problem solving guide

---

### Noises

Problem	Cause and remedy
<b>Knocking noise in the wash cabinet.</b>	A spray arm is knocking against an item in a basket. ■ Interrupt the programme, and rearrange the items which are obstructing the spray arm.
<b>Rattling noise in the wash cabinet.</b>	Items are insecure in the wash cabinet. ■ Interrupt the programme, and rearrange the load.
	A foreign object (e.g. a cherry stone) has become lodged in the drain pump. ■ Remove the foreign object from the drain pump (see “Maintenance, Cleaning the drain pump and non-return valve”).
<b>Knocking noise in the water pipes</b>	This may be caused by the on-site installation or the cross-section of the piping. However, this will not affect the functioning of the dishwasher in any way. ■ If in doubt, contact a suitably qualified plumber.

### Unsatisfactory washing result

Problem	Cause and remedy
<b>The crockery is not clean.</b>	The crockery was not loaded correctly. <ul style="list-style-type: none"> <li>■ Please observe the instructions in “Loading the dishwasher”.</li> </ul>
	The programme was not suitable for the load. <ul style="list-style-type: none"> <li>■ Select a suitable programme (see “Programme chart”).</li> </ul>
	Not enough cleaning agent was dispensed. <ul style="list-style-type: none"> <li>■ Increase the quantity of cleaning agent.</li> </ul>
	The cleaning agent used is not suitable for the type of soiling present. <ul style="list-style-type: none"> <li>■ Switch to another cleaning agent.</li> </ul>
	Items are blocking the path of the spray arms. <ul style="list-style-type: none"> <li>■ Carry out a rotation check and if needed, rearrange the items so that the spray arms can rotate freely.</li> </ul>
	The filter combination in the wash cabinet is not clean or was incorrectly fitted. This may have caused the spray arm jets to become blocked. <ul style="list-style-type: none"> <li>■ Clean and/or fit the filter combination correctly.</li> <li>■ Clean the spray arm jets, if necessary (see “Cleaning and care”).</li> </ul>
	The non-return valve is open and blocked. Dirty water has flowed back into the wash cabinet. <ul style="list-style-type: none"> <li>■ Clean the drain pump and the non-return valve (see “Problem solving guide”).</li> </ul>
	If necessary, alter the temperature and/or the holding time of the programme being used. <ul style="list-style-type: none"> <li>■ Change the relevant parameters for the programme. (see “Further settings, Additional functions”)</li> </ul>
<b>Smearing appears on glassware and cutlery. There is a bluish sheen on the surface of glassware; film can be wiped off.</b>	The rinsing agent dosage is set too high. <ul style="list-style-type: none"> <li>■ Reduce the dosage (see “Further settings, Additional functions, Dispensing systems”).</li> </ul>
<b>Crockery is not dry or cutlery and glasses are flecked.</b>	The rinsing agent dosage is set too low or the rinsing agent reservoir or container is empty. <ul style="list-style-type: none"> <li>■ Replenish the rinsing agent, increase the dosage or change the brand of rinsing agent used (see “Adding rinsing agent”).</li> </ul>

## Problem solving guide

Problem	Cause and remedy
<b>White residue is visible on crockery and cutlery, clouding occurs on glassware; film can be wiped off.</b>	The rinsing agent dosage is set too low. ■ Increase the dosage (see “Further settings, Additional functions, Dispensing system”).
	There is no salt in the salt reservoir. ■ Fill the salt reservoir (see “Filling the salt reservoir”).
	The water softener is programmed to too low a water hardness level. ■ Programme the water softener to the correct value (see “Further settings, Water hardness”).
<b>Glassware has a brown or blue tinge, and film cannot be wiped off.</b>	This may be caused by the ingredients of the cleaning agent. ■ Switch to another cleaning agent.
<b>Glassware is dull and discoloured; film cannot be wiped off.</b>	The glassware is not dishwasher-proof. The surfaces are affected. ■ Purchase glassware which is dishwasher-proof.
<b>Tea or lipstick stains have not been completely removed.</b>	The wash temperature of the selected programme was too low. ■ Select a programme with a higher main wash temperature.
	The bleaching effect of the cleaning agent used is too low. ■ Switch to another cleaning agent.
<b>Plastic items are discoloured.</b>	Natural dyes e.g. from carrots or tomatoes may be the cause. The amount of detergent used or its bleaching effect was not sufficient to deal with natural dyes. ■ Use more detergent (see “Operation, Detergent”).  Discoloured plastic items will not regain their original colour.
<b>There are rust stains on cutlery.</b>	The affected items are not corrosion-resistant. ■ Purchase cutlery that is dishwasher-safe.
	The “Cold” programme was not run after dishwasher salt was added. Traces of salt have got into the normal wash cycle. ■ Always run the “Cold” programme without any load items after refilling the salt.
	Rust or superficial rust has built up in the wash cabinet, e.g. due to an excessively high iron content in the water or rust on other load items. ■ Discard any rusty load items.



## Cleaning the water inlet filter

A filter is incorporated in the screw thread to protect the water intake valve. If the filter is soiled, insufficient water flows into the wash cabinet.

⚠ Risk of electric shock from mains voltage.

The plastic housing of the water connection contains an electrical valve. The housing must not be dipped in water.

- Disconnect the dishwasher from the mains.  
To do this, turn off the dishwasher, switch off at the socket and unplug it.
- Close the stopcock.
- Unscrew the water intake valve.

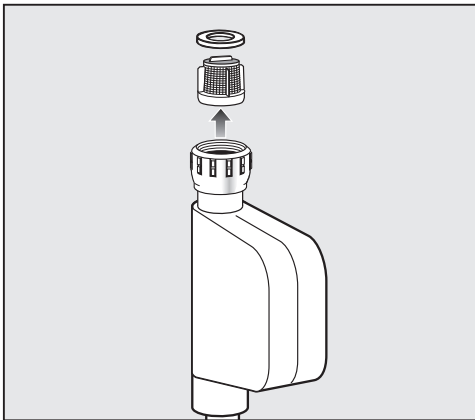

- Remove the seal from the screw thread.
- Using combination or pointed pliers, take hold of the plastic filter bar and remove the filter.
- Rinse the filter under running water.
- Reassemble in reverse order.

Screw the screw thread securely back onto the stopcock. Slowly turn on the stopcock. If water drips out, tighten the connection.

**Never** forget to put the filter back in place after cleaning.

## Maintenance

### Cleaning the drain pump and non-return valve

If the water has not been pumped away at the end of a wash programme (excluding the Super short programme), there may be a foreign object blocking the drain pump or the non-return valve. These are easy to remove.

- Disconnect the dishwasher from the electrical supply (switch the machine off, unplug it, or disconnect or disable the circuit breaker).
- Take the filter combination out of the wash cabinet (see “Cleaning and care”).

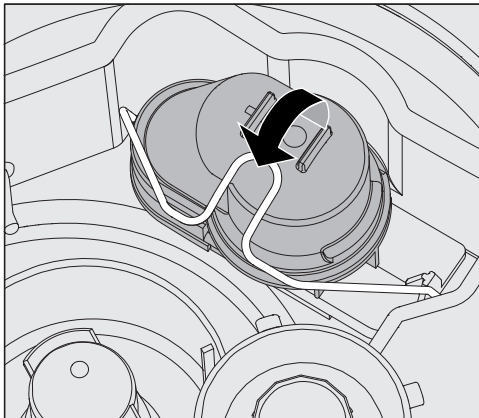

- Open the locking clamp.
- Lift out the non-return valve and rinse well under running water.
- Make sure that the vent on the outside of the non-return valve is not blocked (this vent is only visible after the non-return valve has been taken out). If it is blocked, use a pointed object to release the blockage.

The drain pump is situated under the non-return valve (see arrow).

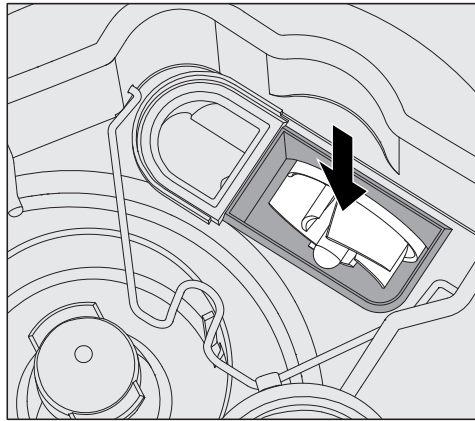

- Check for foreign objects blocking the drain pump before replacing the non-return valve.
- Carefully replace the non-return valve and secure it with the locking clamp.

### Customer Service Department

If, despite following the notes in these operating instructions, you are unable to rectify a problem, please contact one of the following, quoting the fault code shown on the display:













- Your Miele dealer
- The Miele Customer Service Department

Contact details for Miele are provided at the back of these operating instructions.

■ When contacting the Customer Service Department, you will need the model number and 8-digit machine number of the dishwasher.

Both are shown on the data plate, located at the top of the door.

# Programme chart

Programme	Application	Cleaning agent (if liquid cleaning agent is <b>not</b> dispensed)
		The following dosages are based on Miele detergents. <b>Please follow the manufacturer's instructions.</b>
 Short	“Quick programme” for lightly soiled load items with fresh, easily removed food residues.	20–25 g or 1 tablet
 Universal	For normally soiled load items.	20–25 g or 1 tablet
 Intensive	For heavily soiled load items.	20–25 g or 1 tablet
 Cutlery	Special programme for cutlery.	20–25 g or 1 tablet
 Beer glasses	Special programme for beer glasses. The glasses do not dry through their own heat after the programme has ended and may have to be dried by hand.	20–25 g or 1 tablet
 Hygiene	For load items that must be hygienically reprocessed.	20–25 g or 1 tablet
 Glasses	Special glassware programme.	20–25 g or 1 tablet
 Plastics	Special programme for plastic items and other lightweight load items.	20–25 g or 1 tablet
 EnergySave	Energy-saving programme offering the most efficient combined energy and water consumption for normally soiled crockery.	20–25 g or 1 tablet
 Reactivation	Manual reactivation. This can be run to avoid being forced to run a reactivation programme during busy periods.	
 Cold	Use for rinsing heavily soiled load items and to prevent soiling from drying on. Also used for flushing salt residues out after refilling the salt container.	
 Drain	For pumping away the water when, for example, the water for the Super short programme needs to be renewed or a programme has been cancelled.	

# Programme chart

Programme sequence					
1. Pre-wash	2. Pre-wash	3. Main wash (1)/(2)	4. Interim rinse	5. Interim rinse	6. Final rinse (1)/(2)
X		X 55 °C 1 min		(X)	X 60 °C 1 min
X		X 55 °C 2 min	X	(X)	X 60 °C 1 min
X	X	X 65 °C 3 min	X	(X)	X 60 °C 1 min
	X	X 60 °C 2 min	X	(X)	X 55 °C 1 min
		X 50 °C 1 min	X	(X)	X - (3) 1 min
X		X 70 °C 10 min	X	(X)	X 60 °C 1 min
		X 50 °C 1 min	X	(X)	X 50 °C 1 min
X		X 50 °C 5 min	X	(X)	X 60 °C 1 min
		X 46 °C 15 min	X	(X)	X 50 °C 2 min
Reactivation sequence			X		
	X				

X = stages included in a programme

(X) = optional stages which can be selected (see "Further settings, Additional functions")

(1) Temperature ranges from 30–70 °C (see "Further settings, Additional functions").

(2) Holding time ranges from 0–10 minutes (see "Further settings, Additional functions").

(3) Runs with cold water and without surfactant.

# Installation

## Installation

⚠ Damage caused by condensation. In order to reduce the risk of damage from condensation, the furniture in the area around the dishwasher should be designed for commercial use. Only use furniture that is designed for commercial use.

The dishwasher must be stable and horizontal. Any unevenness in the floor level and height of the machine can be compensated for by adjusting the four feet.

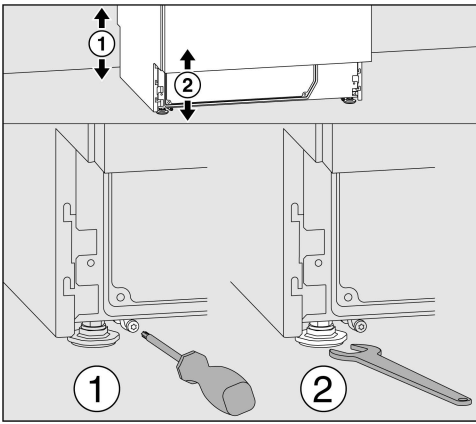

The machine height can be adjusted from 820–880 mm using the machine feet. Dishwashers with lids have an additional 15 mm in height.

The front machine feet can be adjusted with an open spanner (spanner size 13); the rear ones can be adjusted with a T20 Torx screw.

If the runners of the rear machine feet are not fitted, the machine feet can also be adjusted with the open spanner. They are adjusted upwards when turned clockwise and downwards when turned anti-clockwise.

If the dishwasher is to be installed next to other machines and furniture or in a recess, an installation space measuring at least 600 mm in width and 580 mm in depth is required.

## Built-under installation

⚠ Risk of the machine tipping. To ensure stability, a built-under dishwasher must only be installed beneath a continuous worktop that is bolted to the adjacent cabinetry. Install the dishwasher underneath a bolted continuous worktop.

If the dishwasher is to be installed beneath a continuous worktop, an installation space measuring at least 600 mm wide, 580 mm deep and 820 mm high is required.

Dishwashers with a plinth return are supplied with a plinth filler panel. This can be fitted instead of a skirting board.

When adjusting the dishwasher height, the feet must not be unscrewed by more than 60 mm.

## Hose holder

The supplied hose holders can be used to lay the power cable and the hoses for supply and waste water in a way that saves space.

The hose holder prevents hoses from kinking or crushing when installing the machine in tight recesses.

The power cable and hoses can be laid either on the left or the right, depending on the connection situation.

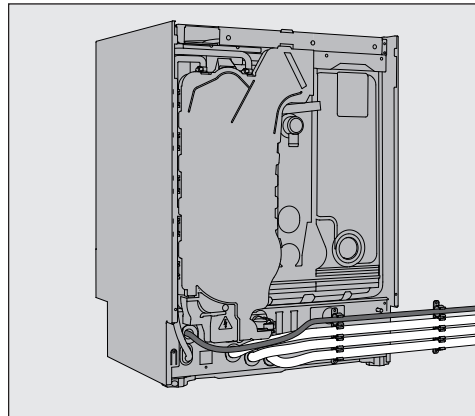

## Adjustable plinth panel (depending on the model)

Dishwashers with internal dispensing or active drying have an adjustable plinth panel.

- Level the dishwasher.
- Open the dishwasher door halfway and loosen the two screws now visible at the top of the plinth panel.
- Pull the plinth panel upwards first and then forwards.
- Loosen the two screws on the right and left of the plinth behind the panel.
- Pull the inside of the plinth down to the floor.
- Tighten the two screws again.
- Reassemble the plinth panel by following the instructions above, but in reverse order.

## Removing the machine lid

If the dishwasher is fitted with a lid, it can be removed as follows:

- Remove both securing screws on the back of the dishwasher with a screwdriver.
- Open the door.

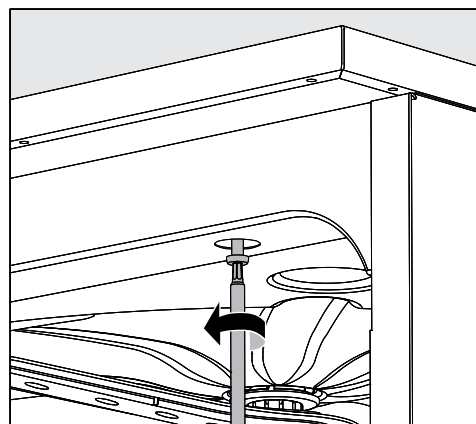

- Unscrew the left and right fastening screws with a screwdriver.
- Lift the machine lid upwards to remove.

# Installation

## Levelling and securing the dishwasher

To guarantee stability, the dishwasher must be secured to the worktop after levelling.

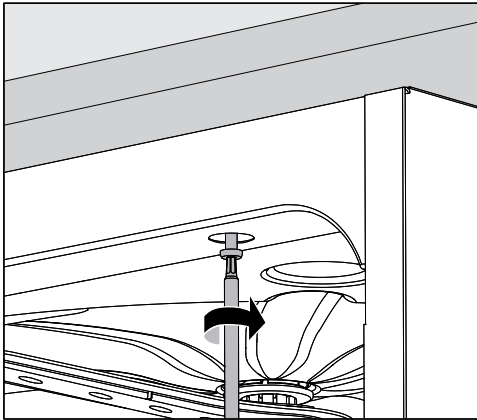

- After levelling, secure the dishwasher to the continuous worktop. With the door open, screw into the worktop through the holes in the front trim on the left- and right-hand sides of the dishwasher.

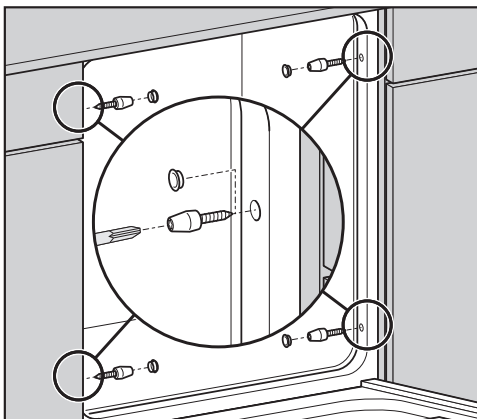

With stainless-steel or stone worktops, the dishwasher must be secured at the sides to the left and right adjacent cupboards with two screws on each side.

Special screws (4 x 27/Torx T20) are supplied in the accessory pack.

Holes must be drilled in the side wall in front of the door seal for this.

In the case of built-under dishwashers, the holes are already provided in the side walls.

The gaps between built-under dishwashers and adjacent cabinets or machines must not be filled with silicone sealant as this could compromise the ventilation of the circulation pump.

Depending on the specific built-under installation situation, the stainless steel cover plate supplied can be attached to the lower edge of the worktop. The stainless-steel cover plate protects the lower edge of the worktop against steam damage.

## Floor anchoring

The dishwasher must be prevented from tilting or moving by anchoring both rear machine feet to the floor.

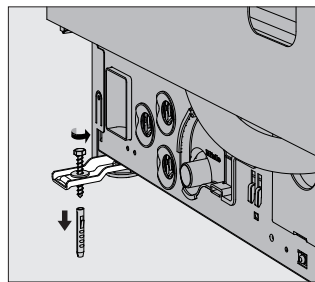

- Fix the floor anchoring to the floor at the same distance as the two rear machine feet using the anchoring kit supplied.
- If necessary, adapt the anchoring to the respective ground conditions on site.
- Slide the dishwasher into the designated holder of the floor anchoring.



## Moving the dishwasher

Before moving the dishwasher, screw in the adjustable feet fully so that they do not get damaged.

⚠ Component damage caused by carrying.

Do not lift the dishwasher by any protruding components, e.g. the control panel.

These could break off.

Do not hold onto protruding components when moving the dishwasher.

⚠ Damage caused by transportation using a sack truck.

Using a sack truck to subsequently move the dishwasher may cause damage to the machine.

Only transport the dishwasher on a sack truck in its original packaging. For subsequent moves, the dishwasher must be placed on a continuous base to avoid damage.

# Electrical connection

## Electrical connection

 Danger caused by improper electrical connection

All electrical work must be carried out by a suitably qualified electrician in accordance with local and national safety regulations.

Ask a qualified specialist to complete the electrical connection work.

- The electrical installation must be in compliance with current local and national safety regulations (DIN VDE 0100 in Germany).
- The connection to the power supply must comply with national regulations (plug and socket must be accessible after the machine has been installed). An electrical safety test can then easily be carried out in line with VDE 0701, e.g. after any service or maintenance work.
- It is recommended to connect the product with a suitably rated plug and socket.
- If the dishwasher is hard wired to the power supply, connection should be made via a mains switch with all-pole isolation. The mains switch must ensure a gap of at least 3 mm between all open contacts and must be able to be locked in the off position.
- For increased safety, it is recommended to protect the machine with a suitable residual current device (RCD Type A) with a trip current of 30 mA (DIN VDE 0664).
- Equipotential bonding should be carried out if required.
- The mains connection cable may only be replaced by an original Miele spare part.
- For technical data, see the data plate or wiring diagram supplied.

The machine must only be operated with the voltage, frequency and fuse rating shown on the **data plate**.

This machine **can be converted to a different type of power supply** in accordance with the conversion diagram and wiring diagram supplied.

The **conversion diagram** and the **data plate** are on the dishwasher or supplied with it.

## Equipotential bonding connection

There is a screw connection point marked  at the back of the dishwasher, to which additional equipotential bonding can be connected.

## Peak-load negotiation

The dishwasher is suitable for use in an energy management system. For this purpose, the dishwasher must be technically adapted and the controls reset by the Miele Customer Service Department.

Please contact the Miele Customer Service Department for further information.

## Load management

In the event of a peak-load negotiation, some dishwasher components, such as the heater elements, will be switched off for a while. The dishwasher will remain on during this period and the current programme will not be interrupted. If one of the components that is switched off is needed during the current programme stage, the programme running time will simply increase for the duration of the load negotiation.

Load negotiation is indicated by the following message, e.g.:

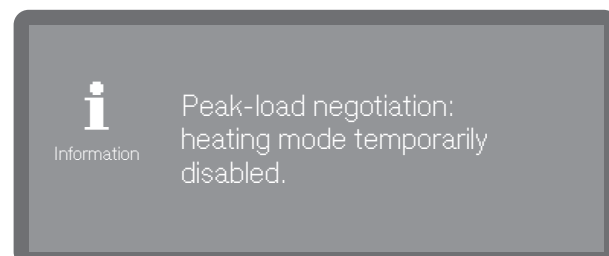

## Connecting the water inlet

⚠ Health risk posed by process chemicals

Water in the dishwasher must not be used as drinking water.

Do not drink water from the dishwasher.

Do not re-use removable sets of hoses. Use the sets of hoses supplied with the dishwasher.

- The dishwasher must be connected to the water supply in strict accordance with current local and national water authority regulations.
  - The water used must comply with the Water Supply (Water Quality) Regulations. If the water supply has a high iron content, there is a risk of corrosion occurring on load items in the dishwasher, as well as the dishwasher itself. If the chloride content of the water exceeds 100 mg/l, the risk of corrosion on load items will be increased considerably.
  - In certain regions (e.g. mountainous regions), the water composition may cause precipitates to form, requiring the use of softened water for the dishwasher.
  - The water pressure (flow pressure) must amount to at least 200 kPa pressure (100 kPa = 1 bar). At a water pressure (flow pressure) below 200 kPa, the water inlet time extends automatically. The maximum permissible static pressure amounts to 1000 kPa (overpressure). If the water pressure does not lie in the 200–1000 kPa range, contact the Miele Customer Service Department for advice.
  - The dishwasher is supplied as standard for connection to cold water (blue coded hose) and hot water up to max. 60 °C (red coded hose). Connect the inlet hoses to the stopcocks for cold and hot water.
  - If no hot water supply is available, the inlet hose with the **red** marking for the hot water connection must also be connected to the cold water supply.
- A stopcock with a 3/4 inch screw thread must be provided on site for the connection. The valve should be easily accessible, since the water inlet should be shut off whenever the machine is not in use.
  - The inlet hose is a DN 10 pressure hose measuring approx. 1.7 m in length, terminating in a 3/4 inch screw thread. A 1.5 m long flexible metal extension hose (tested to 140 bar) is available as an optional accessory if required. On no account may the inlet filter in the screw thread be removed.

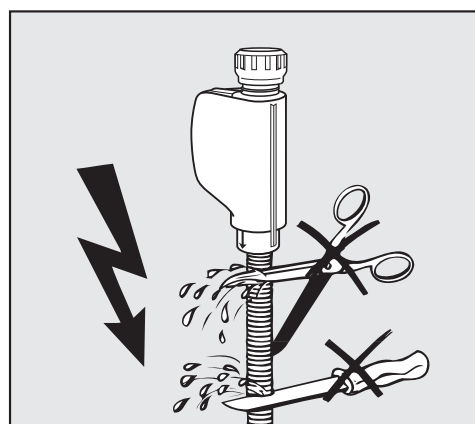

⚠ Damage caused by shortening the hose.

Do **not shorten** or otherwise damage the inlet hoses supplied with the machine. Do not shorten the inlet hoses.

Please also refer to the installation plan provided.

# Plumbing

## Water Regulations compliance in the UK

For the dishwasher to comply with the Water Supply (Water Fittings) Regulations and Bylaws, the supplied double check valves must be fitted to the hot and cold water connections between the stopcock and the dishwasher water inlet hoses.

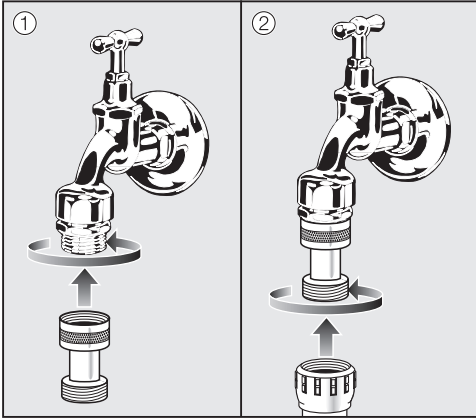

- Screw the non-return valve onto the stopcock.
- Screw the water inlet hose onto the thread of the non-return valve.

## Connecting the drain hose

- The dishwasher drainage system is fitted with a non-return valve, which prevents dirty water from flowing back into the dishwasher via the drain hose.
- The dishwasher drain hose should be connected to a **separate** on-site drainage system for the dishwasher only. If no separate connection is available, we recommend connecting it to a dual-chamber siphon. The on-site connection must be between 0.3 m and 1 m in height, measured from the lower edge of the machine. If the connection is lower than 0.3 m, the drain hose must be placed in an arc at least 0.3 m high.
- The dishwasher is supplied with approx. 1.5 m of flexible drain hose with an internal diameter of 22 mm. Hose clips are supplied with the dishwasher.
- The drain hose must not be shortened. The hose can be extended using a connection piece to attach a further length of hose. The drainage length must not be longer than 4 m.
- The drainage system must be able to accommodate a minimum drainage flow of 16 l/min.

⚠ Damage caused by incorrect routing. Make sure that there are no kinks in the drain hose and that it is not squashed or stretched.

Make sure that there are no kinks in the drain hose and that it is not squashed or stretched.

Please refer to the installation plan provided.

## Technical data

Height with machine lid Height without machine lid	835 mm (adjustable + 60 mm) 820 mm (adjustable + 60 mm)
Width	598 mm
Depth Depth with door open	580 mm 1.180 mm
Weight (net)	ca. 70 kg
Voltage, rated load, fuse rating	See data plate
Mains connection cable	Approx. 1,7 m
Water connection temperature: Cold water Hot water	Max. 20 °C Max. 60 °C
Static water pressure	1.000 kPa overpressure
Minimum water connection flow pressure: Cold water Hot water	200 kPa overpressure 200 kPa overpressure
Recommended water connection flow pressure: Cold water/hot water	≥ 200 kPa overpressure
Water inlet hose	Approx. 1,7 m
Drain hose	Approx. 1,5 m
Delivery head	Min. 0,3 m, max. 1,0 m
Drainage length	Max. 4,0 m
Operating conditions: Ambient temperature Maximum relative humidity Linear decrease to Minimum relative humidity	5 °C to 40 °C 80 % for temperatures up to 31 °C 50 % for temperatures up to 40 °C 10 %
Storage and transportation conditions: Ambient temperature Relative humidity Air pressure	-20 °C to 60 °C 10 % to 85 % 500 hPa to 1060 hPa
Altitude above sea level (according to IEC/EN 60335)	Up to 2.000 m*
Protection category (according to IEC 60529)	IP21
Noise emission values Sound power in LwA Sound pressure in LpA	Built-under machine with wooden beam in front of plinth on Short programme 59 dB (A) 47 dB (A)
WiFi standard	802.11 b/g/n
WiFi frequency band	2400-2483,5 MHz
Maximum WiFi transmission power	< 100 mW
Test certifications	EMC, VDE, radio and television suppressed
CE marking	Machinery Directive 2006/42/EC
UKCA mark (UK only)	The Supply of Machinery (Safety) Regulations 2008
Manufacturer address	Miele & Cie. KG, Carl-Miele-Straße 29, 33332 Gütersloh, Germany

\* If installation site is above 2.000 m, the boiling point of the wash water will be lower. For this reason, the programme parameters may have to be adjusted.





## United Kingdom

Miele Co. Ltd., Fairacres, Marcham Road  
Abingdon, Oxon, OX14 1TW  
Professional Sales, Tel: 0845 365 6608  
E-mail: professional@miele.co.uk  
Internet: www.miele.co.uk/professional

## Australia

Miele Australia Pty. Ltd.  
ACN 005 635 398, ABN 96 005 635 398  
Level 4, 141 Camberwell Road, Hawthorn East, VIC 3123  
Tel: 1300 731 411  
Internet: www.miele.com.au/professional  
E-mail: sales@miele-professional.com.au

## China Mainland

Miele Electrical Appliances Co., Ltd.  
1-3 Floor, No. 82 Shi Men Yi Road  
Jing' an District, 200040 Shanghai, PRC  
Tel: +86 21 6157 3500, Fax: +86 21 6157 3511  
E-mail: info@miele.cn, Internet: www.miele.cn

## Hong Kong, China

Miele (Hong Kong) Ltd.  
41/F - 4101, Manhattan Place  
23 Wang Tai Road, Kowloon Bay, Hong Kong  
Tel: (852) 2610 1025, Fax: (852) 3579 1404  
Email: customerservices@miele.com.hk  
Website: www.miele.hk

## India

Miele India Pvt. Ltd.  
1st Floor, Copia Corporate Suites,  
Commercial Plot 9, Mathura Road, Jasola,  
New Delhi - 110025  
E-mail: customercare@miele.in, Website: www.miele.in

## Ireland

Miele Ireland Ltd.  
2024 Bianconi Ave., Citywest Business Campus, Dublin 24  
Tel: (01) 461 07 10, Fax: (01) 461 07 97  
E-Mail: info@miele.ie, Internet: www.miele.ie

## Malaysia

Miele Sdn Bhd  
Suite 12-2, Level 12  
Menara Sapura Kencana Petroleum  
Solaris Dutamas No. 1, Jalan Dutamas 1  
50480 Kuala Lumpur, Malaysia  
Phone: +603-6209-0288  
Fax: +603-6205-3768

## New Zealand

Miele New Zealand Limited  
IRD 98 463 631  
8 College Hill  
Freemans Bay, Auckland 1011, NZ  
Tel: 0800 464 353  
Internet: www.miele.com.au/professional  
E-mail: sales@miele-professional.com.au

## Singapore

Miele Pte. Ltd.  
29 Media Circle, #11-04 ALICE@Mediapolis  
Singapore 138565  
Tel: +65 6735 1191, Fax: +65 6735 1161  
E-Mail: info@miele.com.sg  
Internet: www.miele.sg

## South Africa

Miele (Pty) Ltd  
63 Peter Place, Bryanston 2194  
P.O. Box 69434, Bryanston 2021  
Tel: (011) 875 9000, Fax: (011) 875 9035  
E-mail: info@miele.co.za  
Internet: www.miele.co.za

## United Arab Emirates

Miele Appliances Ltd.  
Showroom 1, Eiffel 1 Building  
Sheikh Zayed Road, Umm Al Sheif  
P.O. Box 114782 - Dubai  
Tel. +971 4 3044 999, Fax. +971 4 3418 852  
800-MIELE (64353)  
E-Mail: info@miele.ae, Website: www.miele.ae



Manufacturer: Miele & Cie. KG  
Carl-Miele-Straße 29, 33332 Gütersloh, Germany