

Miele

Quick Start Guide



for dishwashers

These short instructions are not a substitute for the operating instructions supplied with the machine.

It is essential to familiarise yourself with the dishwasher before using it for the first time. Take note of the Warning and Safety instructions, as well as the full descriptions on how to use your appliance.

en-AU, NZ

M.-Nr. 12 577 620 /
00

Guide to the appliance

Control panel



- ① **On/Off sensor**
For switching the dishwasher on and off.
- ② **In-operation indicator light**
For indicating an ongoing wash programme when the door is closed.
- ③ **MobileStart sensor**
For activating/deactivating the MobileStart option.
- ④ **Programme selection**
 - ECO = ECO
 - Auto = Auto 45–60 °C
 - 45 °C = ComfortWash 45 °C
 - 60 °C = PowerWash 60 °C
 - 75 °C = Intensive 75 °C
 - = Further programmes/
Settings
- ⑤ **Extras sensor**
For selecting Extras.
- ⑥ **Quick sensor**
For reducing the programme running time.
- ⑦ **AutoDos sensor**
For activating/deactivating AutoDos.
- ⑧ **Timer sensor**
For selecting a later programme start.
- ⑨ **Display**
For further information, see “Guide to the appliance - Display functions” in the operating instructions.
- ⑩ **Back sensor**
For navigating back to the previous menu or deleting values which have been set previously.
- ⑪ **Up/Down sensors**
For selecting “Further programmes”.
For changing the values displayed.
For scrolling to other menu pages.
- ⑫ **OK sensor**
For selecting menu options and values displayed.
For confirming messages.

Brief instructions

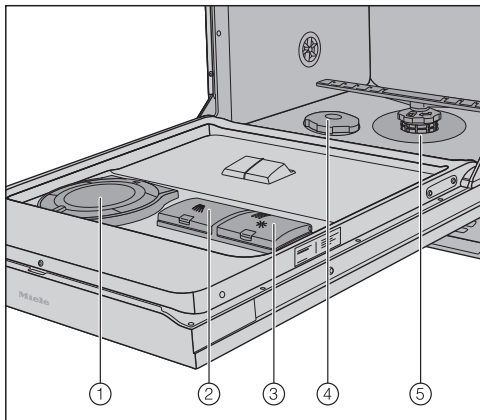

- ① AutoDos (automatic dispensing)
- ② Detergent compartment
- ③ Rinse aid reservoir
- ④ Salt reservoir
- ⑤ Filter combination

Opening the door

The dishwasher has a motorised door opener which is activated by knocking on the door front (Knock2open function).

- Knock twice in quick succession on the top third of the door front.

The door will open a little.

① Filling the salt reservoir (depending on water hardness)

- Remove the lower basket from the wash cabinet and unscrew the salt reservoir cap.

⚠ Risk of corrosion due to saline solution.

Water or saline solution will run out of the reservoir when the cap is opened. Saline solution that runs out can cause corrosion in the wash cabinet and to the dishwasher load. The salt reservoir should therefore only be opened to replenish the salt.

⚠ Damage to the water softener from detergents.

Dishwasher detergent will damage the water softener.

Do not fill the salt reservoir with powder or liquid detergent.

- Fill the salt reservoir with approx. 1.5 litres of water (first use only).
- Place the funnel provided over the salt reservoir and carefully fill with dishwasher salt until the reservoir is full.
- Clean any excess salt from around the reservoir opening and then screw the salt reservoir cap on again firmly.
- Run the *Rinse salt* programme immediately without a load in order to remove any traces of salt from the cabinet.

2 Adding rinse aid ✨ (if not using AutoDos or all-in-1 tabs)

- Lift the yellow button on the lid of the rinse aid container ✨.
- Only fill with rinse aid until the fill level indicator turns dark when the door is open horizontally.
- Close the lid making sure it clicks into place.
- Wipe up any spilled rinse aid. This prevents over-foaming occurring during the next programme.

3 Loading the dishwasher

4 Detergent dispensing

There are two ways of dispensing the detergent.

During automatic dispensing, the AutoDos function will automatically dispense the required amount of detergent for each programme once a PowerDisk has been inserted.

If you have deactivated automatic dispensing, you can dispense detergent manually.

Automatic detergent dispensing

Before you can use AutoDos, you must insert a PowerDisk containing powder detergent into the PowerDisk compartment.

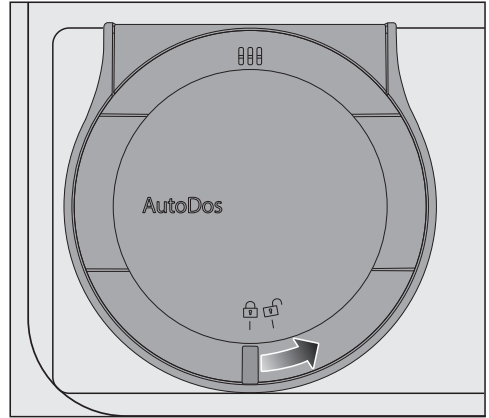

- Before you first use AutoDos, remove the tab from the AutoDos lid.
- Slide the yellow catch of the AutoDos lid to  and open it.

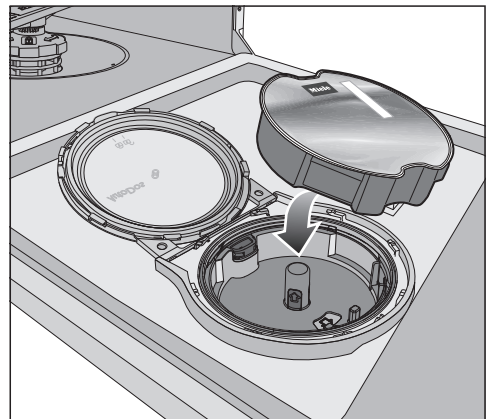

- Insert the new PowerDisk and press it evenly downwards until it sits flush.
- Close the AutoDos lid and slide the yellow catch until it is aligned with the  symbol.

This activates the *AutoDos* function.

If the PowerDisk is not in the correct starting position, it will be rotated automatically.

Wait until this process is finished before you start a programme.

Manual detergent dispensing

Dispense detergent manually if you have deactivated automatic dispensing.

- Follow the detergent dosage recommended by the manufacturer on the packaging.
- Unless directed otherwise, use one detergent tab or add 20 to 30 ml of detergent to the detergent compartment, depending on the degree of soiling of the crockery.
- Lift the yellow catch on the lid of the detergent compartment .

The lid will be open at the end of the programme.

- Fill the detergent compartment with detergent and push the lid shut until you hear it click into place.

5 Switching on

- Turn on the tap if it is turned off.
- Open the door.
- Touch the  sensor.



6 Selecting a programme

- Touch the sensor for the required programme.

Further programmes can be selected under .





7 Selecting Extras (if required)

You can select or deselect the Extras before starting the selected programme.

- Touch the  *Quick* or  *Extras* sensor.
- Select the Extra you want and confirm with *OK*.

You can set whether the selected Extras are to remain permanently activated for the respective programme (see “Settings – Saving Extras” in the operating instructions).

8 Activating the timer (if required)

- Touch the  sensor.
- Select the function you want using the   sensors and confirm with *OK*.
- Enter the required time for the timer using the   sensors and confirm with *OK*.

9 Starting a programme



- Start the programme by closing the door.

10 Programme end - Switching off

At the end of a programme, the optical in-operation indicator light will flash slowly with the door shut. The signal tones might also sound.

The programme has finished when  Finished appears in the display and the door has opened slightly (if applicable).

The drying fan may continue to run for a few minutes at the end of the programme.

- Open the door.
- The dishwasher can be switched off at any time using the  sensor.
- Use the  sensor to select the *Switch appliance off* option.
- Confirm the query *Switch appliance off* with *OK*.

 Risk of damage due to steam. Steam from the dishwasher could damage the edges of delicate worktops when you open the door at the end of the programme if the fan is no longer running.

If you have deactivated the automatic door opening function but would still like to open the door at the end of the programme, make sure that you open the door fully.

11 Unloading the dishwasher

Dishes tend to break and chip more easily when they are hot. Allow the dishes to cool until they are comfortable enough to handle before unloading them.

Cleaning and care

Cleaning the spray arms

Particles of food can get stuck in the spray arm jets and bearings. The spray arms should therefore be inspected regularly (approx. every 2–4 months).

 Do not run a wash programme without the lower spray arm or without the filters fitted.

- Switch the dishwasher off.
- Take out the cutlery tray (if your dishwasher is fitted with one).
- Push the upper spray arm upwards to engage the inner ratchet. Then unscrew the spray arm by rotating the screw thread anti-clockwise (view from below).

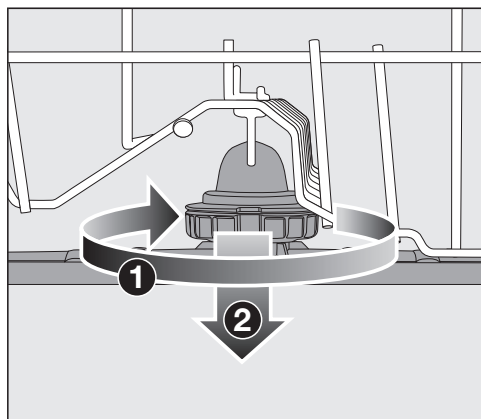

- Rotate the screw thread of the middle spray arm clockwise **1** (view from above) and remove the spray arm **2**.
- Remove the lower basket.

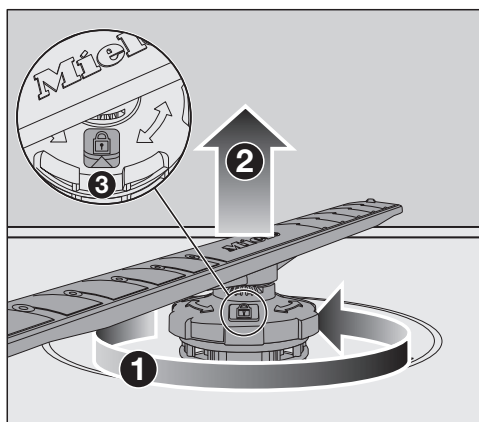

- Rotate the screw thread of the lower spray arm anti-clockwise **1** (view from above) and pull the spray arm upwards to remove **2**.
- Use a pointed object to push food particles stuck in the jets into the spray arm.
- Rinse the spray arm thoroughly under running water.
- Refit the upper and middle spray arms.
- Refit the lower spray arm and ensure that the filter combination lies flat in the base of the wash cabinet.
- Rotate the screw thread of the lower spray arm clockwise until the arrow in the viewing window points **3** to the lock symbol .
- Make sure the spray arms can rotate freely.

Checking the filters in the wash cabinet

 Do not run a wash programme without the filters or without the lower spray arm fitted.

The message *Check filters* will appear in the display after every 50 programme sequences.

- Monitor the condition of the filter combination regularly and clean it if necessary.
- Confirm the message with *OK*.

Cleaning the filters

- Switch the dishwasher off.
- Remove the lower spray arm.
- Before removing the filter combination, remove any coarse soiling to prevent it from entering the circulation system.

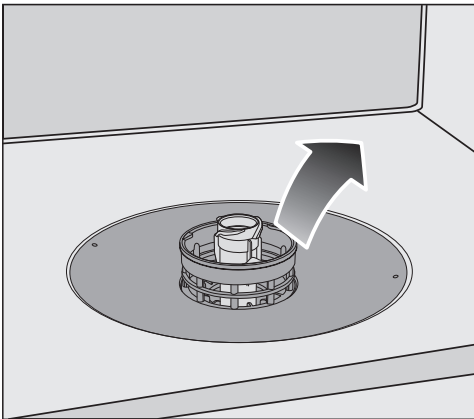

- Remove the filter combination.

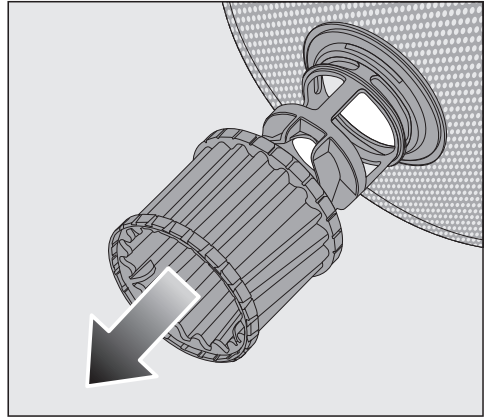





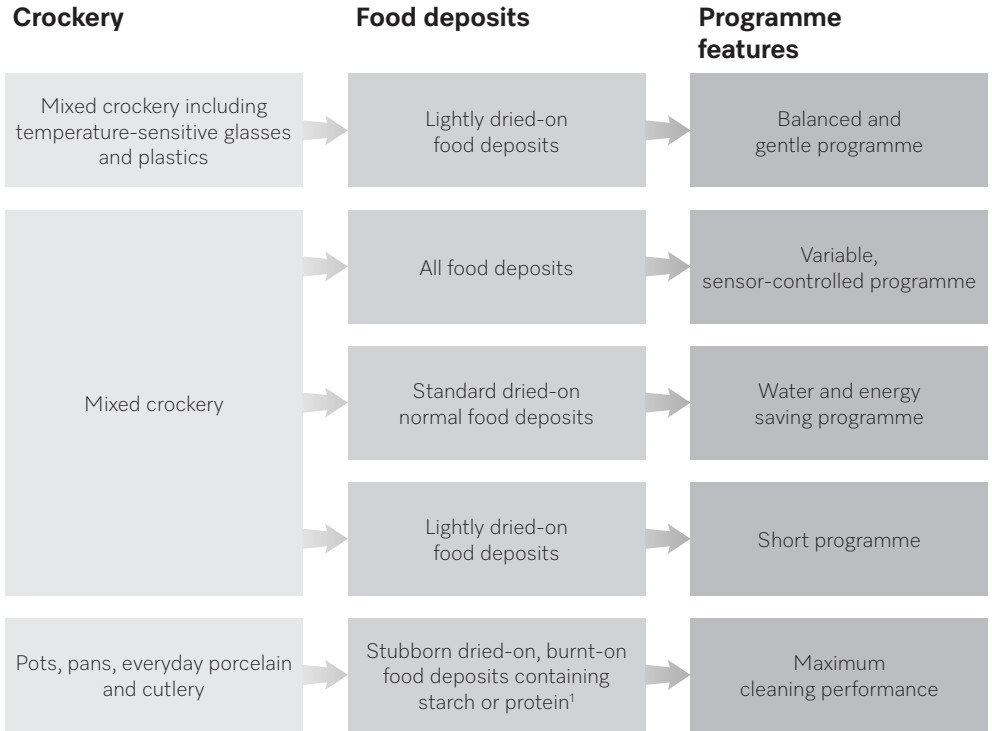









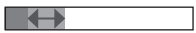

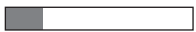

- In order to clean the inside of the filter, pull the microfilter downwards and away from the filter combination.
- Rinse all the parts under running water.
- Push the microfilter back onto the filter combination.
- Refit the filter combination so that it lies flat in the base of the wash cabinet.
- Refit the lower spray arm to the filter combination using the screw thread.
- Rotate the screw thread clockwise until the arrow in the viewing window points to the lock symbol .

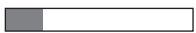
Programme chart



¹ Food such as potatoes, pasta, rice or stews can leave starchy deposits. Deposits containing protein can be left by food such as fried meat or fish.

Programme ²	 ³	Consumption estimate ⁴
→ ComfortWash 45 °C 	30 ml	Energy consumption  Water consumption  Programme duration 
→ Auto 	30 ml	Energy consumption  Water consumption  Programme duration 
→ ECO	30 ml	Energy consumption  Water consumption  Programme duration 
→ PowerWash 60 °C 	30 ml	Energy consumption  Water consumption  Programme duration 
→ Intensive 75 °C 	35 ml	Energy consumption  Water consumption  Programme duration 

² You can use “Extras” to adjust the programmes (see “Extras”).
 You can also select the “2nd interim rinse” function (see “Settings”).

³ Recommended amount of detergent (see “Detergent”).

⁴ The estimated values may change due to the selected settings or Extras,
 or the conditions in which the appliance is being used.