

Operating and Installation Instructions Ventilation Hood



To prevent accidents and damage to the appliance, you **must** read these instructions before installing the appliance and using it for the first time.

Contents

IMPORTANT SAFETY INSTRUCTIONS	4
Caring for the environment	11
Guide to the ventilation hood	12
Description of functions	14
Before using for the first time	15
Selecting extraction mode or recirculation mode.....	15
Setting up Miele@home.....	15
Performing Scan & Connect.....	16
Signing out of WiFi (reset to factory settings).....	16
Setting up Con@ctivity.....	17
Con@ctivity via the home WiFi network (Con@ctivity 3.0).....	17
Con@ctivity via a direct WiFi connection (Con@ctivity 3.0).....	17
Reattempting the connection.....	18
Operation (Automatic mode)	19
Cooking with Con@ctivity (Automatic mode).....	19
Cooking process.....	19
Temporarily exiting Automatic mode.....	20
Resuming Automatic mode.....	20
Operation (Manual mode)	21
Cooking without Con@ctivity (Manual mode).....	21
Turning on the fan.....	21
Selecting the power level.....	21
Selecting the delayed shutdown time.....	21
Turning off the fan.....	22
Dimming/switching the cooktop lighting on/off.....	22
Power management.....	22
Safety shut-off.....	22
Energy-saving tips	23
Changing settings	24
Adjusting the grease filter filter saturation indicator.....	24
Adjusting or deactivating the filter saturation indicator for the charcoal filter.....	25
Deactivating power management.....	25
Cleaning and care	26
Stainless steel housing.....	26
Filter saturation indicator.....	27
Checking the filter saturation indicator.....	27
Grease filter.....	27
Replacing the grease filter.....	30

Contents

OdorFree Charcoal Filter.....	30
Resetting the filter saturation indicator for the charcoal filters	31
Disposing of charcoal filters.....	31
Reactivatable charcoal filters.....	31
Installation	32
Before installation	32
Installation recommendations.....	32
Installation materials.....	32
Installation materials for recirculation mode	33
Appliance dimensions.....	34
Distance between cooktop and ventilation hood (S).....	37
Installing the depth stop (optional)	38
Air venting.....	40
Non-return flap.....	40
Condensate	41
Reducing Collar	41
Electrical connection	42
Customer Service	43
Contact in the event of a fault	43
Location of the data plate	43
Appliance warranty and product registration	43
Technical data	44
Optional accessories for recirculation mode.....	44

IMPORTANT SAFETY INSTRUCTIONS

READ AND SAVE THESE INSTRUCTIONS

This appliance complies with current safety requirements. Improper use of the appliance can lead to personal injury and material damage.

Read all instructions before installing or using the appliance for the first time. Only use the appliance for its intended purpose.

Keep these operating instructions in a safe place and pass them on to any future user.

Appropriate use

- ▶ **CAUTION:** For General Ventilating Use Only. Do Not Use To Exhaust Hazardous Or Explosive Materials And Vapors.
- ▶ This appliance is intended for residential use only. Use only as described in these operating instructions.
- ▶ This ventilation hood is not intended for outdoor use.
- ▶ It must only be used to extract and clean vapors produced during cooking. Any other use occurs at the owner's own risk.
- ▶ Where a recirculation ventilation hood is installed above a gas cooktop, please check that all local codes are observed to insure an adequate supply of fresh air.
- ▶ This appliance is suitable for installation above gas or electric cooking surfaces. Please refer to cooktop instructions.
- ▶ Persons who lack physical, sensory or mental abilities, or experience with the appliance should not use it without supervision or instruction by a responsible person.

Safety with children

- ▶ Children must be kept away from the ventilation hood unless they are constantly supervised.
- ▶ Children must not be allowed to clean or service the hood.
- ▶ Please supervise children in the vicinity of the hood and do not let them play with it.
- ▶ The LED ClearView lighting is very intense. Avoid looking directly into the light for prolonged periods of time.
- ▶ Danger of suffocation! Ensure that any plastic wrappings, bags, etc. are disposed of safely and kept out of the reach of children.

IMPORTANT SAFETY INSTRUCTIONS

Technical safety

▶ **WARNING: TO REDUCE THE RISK OF FIRE, ELECTRIC SHOCK, OR INJURY TO PERSONS, OBSERVE THE FOLLOWING:**

- Use this appliance only in the manner intended by the manufacturer. If you have questions, contact Miele.
- Before servicing or cleaning the appliance, switch power off at the service panel and lock the service disconnecting means to prevent power from being switched on accidentally. If the service disconnecting means cannot be locked, securely fasten a prominent warning device, such as a tag, to the service panel.
- Do not use replacement parts that have not been recommended by the manufacturer (e.g. parts made at home using a 3D printer).

▶ Installation, repair and maintenance work should be performed by a Miele authorized service technician in accordance with national and local safety regulations and the provided installation instructions. Contact Miele's Technical Service Department for examination, repair or adjustment. Repairs and other work by unauthorized persons could be dangerous and may void the warranty.

▶ A damaged ventilation hood can be dangerous. Always check for visible signs of damage. Never use a damaged ventilation hood.

▶ Be certain your appliance is properly installed and grounded by a qualified technician. To guarantee the electrical safety of this appliance, continuity must exist between the appliance and an effective grounding system. It is imperative that this basic safety requirement be met. If there is any doubt, have the electrical system of the house checked by a qualified electrician.

▶ Temporary or permanent operation on an autonomous power supply system or a power supply system that is not synchronized with the grid power supply (e.g., island networks, back-up systems) is possible. A prerequisite for operation is that the power supply system complies with national and local codes.

The function and operation of the protective measures provided in the domestic electrical installation and in this Miele product must also be maintained in isolated operation or in operation that is not synchronized with the grid power supply, or these measures must be replaced by equivalent measures in the installation.

IMPORTANT SAFETY INSTRUCTIONS

▶ To avoid damaging the ventilation hood, make sure that the connection data (voltage and frequency) on the data plate correspond to the building's power supply before connecting the appliance.

If in doubt, consult a qualified electrician.

▶ Do not use a power bar or extension cord to connect the ventilation hood to electricity. These are a fire hazard and do not guarantee the required level of appliance safety.

▶ To ensure safe operation, only use the ventilation hood after it has been properly installed.

▶ This ventilation hood may not be used in non-stationary locations (e.g. on a ship).

▶ Adequate ventilation must be provided when the hood is operated simultaneously with devices that burn gas or other fuels.

▶ Only open the housing as described in the enclosed "Installation diagram" and in the "Cleaning and care" section of this manual.

Under no circumstances should any other parts of the housing be opened.

Tampering with electrical connections or components and mechanical parts is highly dangerous to the user and can cause operation faults.

▶ If the power cord is damaged, it must only be replaced by a qualified service technician.

▶ During installation, maintenance, and repair work, the ventilation hood must be disconnected from the electrical supply. It is only completely isolated from the electricity supply if one of the following applies:

- The circuit breakers on the electrical service panel are tripped.
- The screw-type fuses on the electrical service panel have been removed.
- The power cord (if present) has been unplugged from the socket (pull the plug not the cord).

IMPORTANT SAFETY INSTRUCTIONS

Correct use

▶ **WARNING: TO REDUCE THE RISK OF A COOKTOP GREASE FIRE:**

- a) Never leave surface units unattended. Boilovers cause smoking and greasy spillovers may ignite. Heat oils slowly on low or medium settings.
- b) Always turn the hood on when cooking at a high heat.
- c) Clean the ventilation hood frequently. Grease should not be allowed to accumulate on the fan or filter.
- d) Use the proper pan size. Always use cookware appropriate for the size of the cooking area.

▶ Open flames are a fire hazard.

The use of an open flame under the ventilation hood is not permitted. To avoid the danger of fire, do not flambé or grill over an open flame. When switched on, the ventilation hood could draw flames into the filter. Fat deposits could ignite, presenting a fire hazard.

▶ **WARNING: TO REDUCE THE RISK OF INJURY TO PERSONS IN THE EVENT OF A COOKTOP GREASE FIRE, OBSERVE THE FOLLOWING*:**

- a) **SMOTHER FLAMES** with a close fitting lid, cookie sheet, or metal tray then turn off the burner. **BE CAREFUL TO PREVENT BURNS.** If the flames do not go out immediately, **EVACUATE AND CALL THE FIRE DEPARTMENT.**
- b) **NEVER PICK UP A FLAMING PAN** - You may be burned.
- c) **DO NOT USE WATER**, including wet dishcloths or towels - a violent steam explosion will result.
- d) Use a fire extinguisher **ONLY** if:
 - 1) You have a class ABC extinguisher, and you know how to operate it.
 - 2) The fire is small and contained in the area where it started.
 - 3) The fire department is being called.
 - 4) You can fight the fire with your back to an exit.

*Based on “Kitchen Fire Safety Tips” published by NFPA.

IMPORTANT SAFETY INSTRUCTIONS

- ▶ The ventilation hood may become damaged if exposed to excessive heat from a gas cooktop.
 - When using the ventilation hood over a gas cooktop, ensure that any burners in use are always covered by cookware. Turn burners off when removing the cookware, even if doing so for just a short time.
 - Select cookware that is suitable for the size of the burner.
 - Adjust the flame so that it never extends up the sides of the cookware.
 - Avoid overheating the cookware (e.g., when cooking with a wok).
- ▶ Always turn the ventilation hood on whenever a burner is in use to prevent damage from condensation.
- ▶ Overheated oil and fat can ignite, causing fire damage to the ventilation hood.

Do not leave cookware, pans, and deep-fat fryers unattended when cooking with oil or fat. Similarly, never leave an open flame unattended when grilling.
- ▶ Fat and debris deposits impair the proper functioning of the ventilation hood.

To ensure that cooking vapors are properly cleaned, never use the ventilation hood without the grease filters in place.
- ▶ Please note that the heat rising from the stovetop during cooking can cause the ventilation hood to become very hot.

Do not touch the housing or the grease filters until the ventilation hood has cooled down.

Proper installation

- ▶ **WARNING: TO REDUCE THE RISK OF FIRE, ELECTRIC SHOCK, OR INJURY TO PERSONS, OBSERVE THE FOLLOWING:**
 - a) Installation work and electrical wiring must be done by qualified person(s) in accordance with all applicable codes and standards, including fire-rated construction.
 - b) Sufficient air is needed for combustion and exhausting of gases through the flue (chimney of fuel burning equipment to prevent back drafting. Follow the heating equipment manufacturer's guideline and safety standards such as those published by the

IMPORTANT SAFETY INSTRUCTIONS

National Fire Protection Association (NFPA) and the American Society for Heating, Refrigeration and Air Conditioning Engineers (ASHRAE), and the local code authorities.

- c) When cutting or drilling into the wall or ceiling, do not damage electrical wiring and other hidden utilities.
- d) Ducted hoods must always be vented to the outdoors.
- e) Do not use this hood with any solid-state speed control device.

▶ To determine whether a ventilation hood may be operated above your cooking appliance, please refer to the information provided by the appliance's manufacturer.

▶ Safety regulations prohibit the installation of a ventilation hood over solid fuel stoves.

▶ An insufficient safety distance between the cooktop and the ventilation hood can result in damage to the ventilation hood.

The minimum safety distances between the top of the cooktop and the bottom of the ventilation hood given in the "Installation" section of this manual must be observed, unless the cooktop manufacturer states that a greater safety distance is required.

If more than one cooking appliance is installed beneath the ventilation hood, and they have different minimum safety distances to the ventilation hood, select the greater distance.

▶ The information provided in "Installation" must be observed when installing the ventilation hood.

▶ Components can have sharp edges which may cause injury. Wear gloves to protect your hands.

▶ When installing the exhaust duct, only use pipes or tubes made of non-flammable material. These can be obtained from your Miele dealer or from Miele Technical Service. Always observe local building code requirements when selecting duct material.

▶ Exhaust air should not be vented into a chimney or vent flue which is otherwise in use and should not be channeled into ducting which ventilates rooms with fuel-burning installations.

▶ If exhaust air is to be extracted into a chimney or ventilation duct no longer used for other purposes, seek professional advice.

▶ **WARNING: TO REDUCE THE RISK OF FIRE USE ONLY METAL DUCTWORK.**

IMPORTANT SAFETY INSTRUCTIONS

Cleaning and maintenance

- ▶ There is a risk of fire if cleaning is not completed according to the instructions in this manual.
- ▶ Never use a steam cleaner to clean the ventilation hood. The steam can reach the electrical components and cause a short circuit.

Accessories and parts

- ▶ Use only genuine original Miele parts. If parts or accessories from other manufacturers are used, the warranty may become void.
- ▶ Defective components should be replaced by Miele original parts only. Only with these parts can safety of the appliance be assured as intended by the manufacturer.
- ▶ Miele will guarantee to supply functional parts for a minimum of 10 years and up to 15 years following the discontinuation of your ventilation unit.

Disposal of the packing material

The cardboard box and packing materials protect the appliance during shipping. They have been designed to be biodegradable and recyclable.

Ensure that any plastic wrappings, bags, etc. are disposed of safely and kept out of the reach of children. Danger of suffocation!

Disposal of your old appliance

Electrical and electronic appliances contain valuable materials. They also contain certain substances, compounds and components which were essential for the proper functioning and safe use of the equipment. Handling these materials improperly by disposing of them in your household waste can be harmful to your health and the environment. Therefore, please do not dispose of your old appliance with regular household waste and follow local regulations on proper disposal.



Consult with local authorities, dealers or Miele in order to dispose of and recycle electrical and electronic appliances. Miele assumes no responsibility for deleting any personal data left on the appliance being disposed. Please ensure that your old appliance is kept away from children until removal. Observe safety requirements for appliances that may tip over or pose an entrapment hazard.

Guide to the ventilation hood

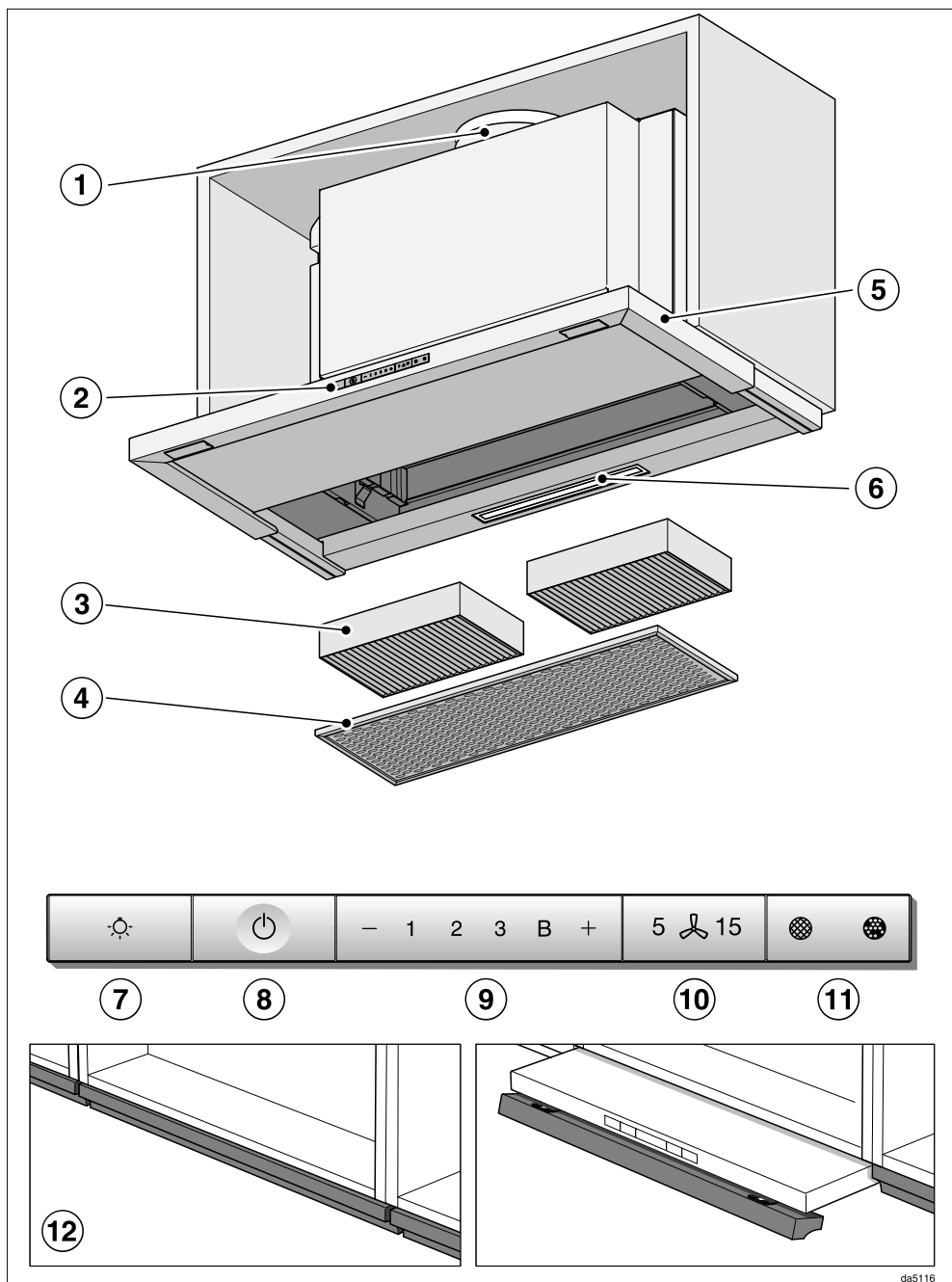

da5116

- ① Vent collar
- ② Controls
- ③ Charcoal filters
Optional accessories for recirculation mode
- ④ Grease filter
- ⑤ Pull-out canopy
- ⑥ Overhead lighting
- ⑦ Control for switching the lighting on and off and for dimming the lighting
- ⑧ Control for switching the blower on and off
- ⑨ Controls for setting the blower power
- ⑩ Control for the delayed shutdown function
- ⑪ Control for the filter saturation indicator
- ⑫ Drop-down front panel
The front panel of the pull-out canopy can be fitted with one that matches your kitchen cabinetry instead (DML 2000 installation kit required).

Description of functions

The following functions are available on your ventilation hood, depending on the model:

Extraction mode



Air entering through the intake is cleaned by the grease filters and conducted out of the building.

Recirculation mode

(only with conversion kit and charcoal filters as optional accessories, see “Technical data”)

ch001941a





ch001941b

The air is drawn in and cleaned first by the grease filter and then by charcoal filters. The air is then circulated back into the kitchen.



Selecting extraction mode or recirculation mode

The ventilation hood can be operated with either extraction mode or recirculation mode. The power of the blower is adapted to suit the selected mode of operation. The ventilation hood is set up at the factory for recirculation mode. The ventilation hood has to be reset for extraction mode.

To reset it for extraction mode, the filter saturation indicator for the charcoal filter(s) has to be deactivated.

- Switch off the blower and the lighting.
- Press the + control and the operating-hours control   at the same time.

The charcoal filter symbol  and one of the blower power level indicators will flash.

- Press and hold the + control until the **B** indicator starts to flash.
- Confirm the selection by pressing the operating-hours control  .

All the indicator lights will go out.

Extraction mode has now been set.

If the selection is not confirmed within 4 minutes, the system will revert to the previous setting.

Setting up Miele@home

Required:

- a WiFi network
- the Miele app
- a Miele user account. You can create a user account via the Miele app.

Your ventilation hood is equipped with an integrated WiFi module. Connect the ventilation hood to your household WiFi network. You will then be able to operate the ventilation hood via the Miele app.

If your Miele cooktop is connected to a home WiFi network, you can control the ventilation hood automatically via the Con@ctivity function.

Before installing the ventilation hood in its final location, ensure that the signal of your WiFi network is strong enough.

Miele@home availability

The ability to use the Miele app depends on the availability of the Miele@home service in your country.

The Miele@home service is not available in every country.

For information about availability, please visit www.miele.com.

Before using for the first time

Performing Scan & Connect

- Scan the QR code.

If you have installed the Miele app and have a user account, you will be taken directly to the networking steps.

If you have not yet installed the Miele app, you will be taken to the Apple App Store® or the Google Play Store™.

- Install the Miele app and set up a user account.
- Scan the QR code again.

The Miele app will guide you through the setup process.



Signing out of WiFi (reset to factory settings)

To set up a new WiFi connection, the existing WiFi connection must be disconnected.

- Switch the ventilation hood off.



- Press and hold the — control.



- Touch the lighting control ☀ at the same time.

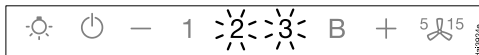

With an existing WiFi connection, **2** and **3** will light up constantly.

The ventilation hood will be ready for disconnection in the next 2 minutes.



- Touch the — control.

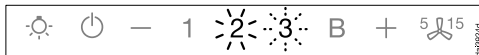

2 will light up constantly, **3** will flash on and off.

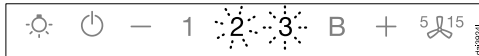

After a few seconds, **2** and **3** will flash on and off. The connection has now been disconnected.



- Exit disconnection mode on the ventilation hood by pressing the delayed shutdown control 5 0 15.

The WiFi connection has now been disconnected. A new connection can now be set up.

das496 DA2XX-qr-v02

Before using for the first time

Setting up Con@ctivity

Con@ctivity is the direct communication system between an induction Miele cooktop and a Miele ventilation hood. It enables the ventilation hood to operate automatically depending on the operational state of a Miele cooktop with onset controls.

- When a burner is turned on, the overhead lighting on the hood turns on automatically. After a brief delay, the ventilation hood blower also comes on.
- The ventilation hood selects the power setting automatically during cooking. The power level selected by the ventilation hood depends on the number of cooking zones being used and their power levels.
- After switching the cooktop off, the blower and the overhead lighting will switch off automatically after a specified period of time.

Detailed information about this function can be found under “Operation”.

Con@ctivity via the home WiFi network (Con@ctivity 3.0)

Prerequisite:

- Home WiFi network
- WiFi-enabled Miele cooktop

- Connect the ventilation hood and cooktop to your home WiFi network (see “Setting up Miele@home”).

The Con@ctivity function will be activated automatically.

Con@ctivity via a direct WiFi connection (Con@ctivity 3.0)

Prerequisite:

- WiFi enabled Miele cooktop

If you do not have a home network, you can establish a direct connection between the cooktop and the ventilation hood.

- Switch the ventilation hood off.



- Press and hold the + control.



- Press the - control at the same time.

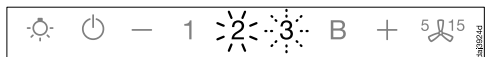

2 will light up constantly, **3** will flash on and off.

The ventilation hood will be ready for connection in the next 2 minutes.

- Start the WiFi connection on the cooktop. For more details, see the cooktop operating instructions.

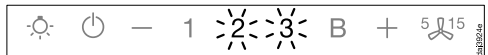

Before using for the first time

When successfully connected, **2** and **3** will light up constantly.



- Quit connection mode on the ventilation hood by pressing the delayed shutdown control ⁵  ¹⁵.

Con@ctivity has now been activated.

With a direct WiFi connection, it is not possible to connect the cooktop and the ventilation hood to a home network. Should this be required at a later date, the direct WiFi connection between the cooktop and the ventilation hood must be disconnected first (see “Signing out of WiFi”).

Reattempting the connection

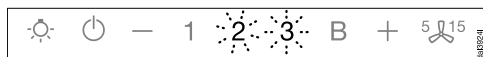

If it is not possible to connect, **2** and **3** flash or the ventilation hood cancels the process.

- Disconnect the connection to the ventilation hood (see “Signing out of WiFi”) and to the cooktop.
- Attempt to make the connection again.

When Con@ctivity is active, the ventilation hood always operates in automatic mode (see “Before using for the first time – Setting up Con@ctivity”).

If you wish to operate the ventilation hood manually; see “Operation (Manual mode) – Cooking without Con@ctivity”.

Cooking with Con@ctivity (Automatic mode)

- Turn on a burner to the desired power setting.

The ventilation hood lighting will come on.

- Pull out the canopy.

The fan will come on at power level **2**.

The ventilation hood selects the power level automatically during cooking.

This level is determined by the total output of the cooktop, i.e., the number of burners in operation and the power levels selected.

- If you select a higher power level on the cooktop or switch on multiple burners, the ventilation hood will switch to a higher fan level.
- If you select a lower power level on the cooktop or turn off a burner, the ventilation hood will accordingly switch to a lower fan level.

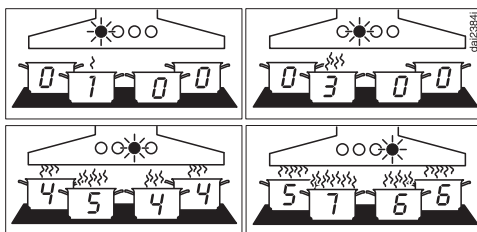

Examples for fan levels **1** to **B**

Reaction time

Changing the power setting on the cooktop does not lead to an immediate increase or decrease in cooking vapors. For this reason, the hood reacts with a slight delay.

Delays can also result from the fact that the cooktop transmits the information to the hood in intervals.

The reaction time can vary from a few seconds to a couple of minutes.

Cooking process

- For example, you switch on a burner at the highest power level to heat cookware for frying. After approx. 10 seconds to 4 minutes, you then reduce the power level (60 seconds to 5 minutes for a HiLight cooktop).

The ventilation hood recognizes a cooking process.

The ventilation hood turns itself on and when the cooktop power level has been reduced, the ventilation hood switches to power level 3 and remains at that level for approx. 5 minutes.

After this, the blower level is once again determined by the Con@ctivity function.

You can also manually select a different blower level before then.

Operation (Automatic mode)

Switching off

- Turn off all burners.

Over the next few minutes, the ventilation hood blower setting will decrease one level at a time until the hood eventually turns off.

This helps to neutralize any lingering vapors and odors in the air.

- From the Booster setting, the blower switches immediately to level 3.
- From level 3, it will switch to level 2 after approx. 1 minute.
- From level 2, it will switch to level 1 after 2 minutes.
- After 2 minutes at level 1, the blower automatically turns off.
- After another 30 seconds, the overhead lighting turns off.

The cooking process is then finished.

If the canopy remains pulled out, the ventilation hood will be switched on automatically the next time the cooktop is switched on:

The fan switches on a few seconds after the cooktop switches on, initially at level 2, before immediately changing to level 1. Operation then continues automatically.

Temporarily exiting Automatic mode

To temporarily exit Automatic mode when cooking:

- Manually select a different blower level; or
- Manually turn the ventilation hood off; or

- Activate the delayed shutdown function  on the ventilation hood. The blower will switch itself off after the selected run-on time, and the lighting will remain on.

The ventilation hood functions are now operated manually (see “Operation (Manual mode)”).

Resuming Automatic mode

The ventilation hood resumes Automatic mode:

- If the ventilation hood has not been used for a period of approx. 5 minutes after the manual selection of a blower level; or
- If the manually selected blower level once again matches the automatic setting; or
- The ventilation hood blower and the cooktop have been switched off for at least 30 seconds. Automatic mode will resume next time the cooktop is switched on.

You can also operate the ventilation hood manually for a complete cooking process.

- To do so, switch the ventilation hood blower on **before** the cooktop.

If the ventilation hood and the cooktop have been switched off for at least 30 seconds after cooking, Automatic mode will resume next time the cooktop is switched on.

Cooking without Con@ctivity (Manual mode)

The ventilation hood can be operated manually if:

- The Con@ctivity function is not activated.
- You have temporarily deactivated the Con@ctivity function (see “Operation (Automatic mode) – Temporarily exiting Automatic mode”).

Turning on the fan

Switch the fan on as soon as you start cooking. This is to ensure that vapors are captured right from the start.

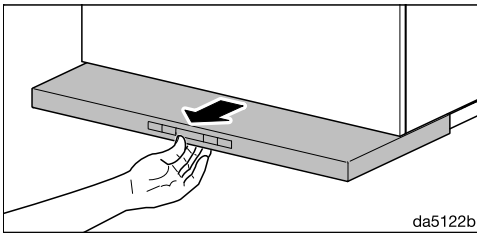

- Pull out the canopy. To ensure optimum extraction and a low noise level, pull the canopy all the way out.

The fan switches on at power level **2**.

Selecting the power level

Power levels **1** to **3** are available for light to heavy cooking vapors and odors.

For strong vapors and odors that are temporarily produced when cooking, e.g., during searing, select the **B** Booster setting.

- Select the power level you want by pressing the **–** or **+** control.

Reducing power down from the Booster setting



If power management is activated (default setting), the blower automatically switches back to level **3** after 5 minutes.

Selecting the delayed shutdown time

It is advisable to run the blower for a few minutes after cooking has finished. This helps to neutralize any lingering vapors and odors in the air.

It also reduces the risk of odors and residues accumulating in the ventilation hood.

The delayed shutdown function enables the blower to continue running for a pre-determined time before switching itself off automatically.

- After you have finished cooking, press the delayed shutdown control **5**  **15** while the blower is still running.
- Once: blower turns off after 5 minutes (**5** lights up).
- Twice: blower turns off after 15 minutes (**15** lights up).
- If you touch the delayed shutdown control **5**  **15** again, the blower will remain switched on (**5**  **15** will go out).

Operation (Manual mode)

Turning off the fan

- Push in the canopy.

The next time the canopy is pulled out, the fan will operate at power level 2 again.



- Or switch the fan off with the On/Off control .

The  symbol will go out.

Dimming/switching the cooktop lighting on/off

- You can turn the cooktop lighting on and off by pulling out the canopy and pushing it in again or by pressing the lighting control .

The lighting will switch on at maximum brightness.

- With the lighting switched on, press and hold the lighting  control. The brightness will gradually dim until the control is released.
- To increase the brightness, press and hold the lighting  control again until the desired level has been reached and then release it.



Power management

The ventilation hood is equipped with a power management system. Power management helps to save energy. It ensures that the blower power level is reduced automatically and that the lighting is switched off.

- If the booster level is selected, the blower automatically switches to level 3 after 5 minutes.
- If the blower is set to level 3, 2, or 1, it switches back one blower setting after 2 hours and then in 30-minute intervals until the blower eventually switches off.
- The overhead lighting will switch off automatically after 12 hours.

Safety shut-off

If power management has been deactivated, the ventilation hood will switch itself off automatically after 12 hours if it has been left on (blower and overhead lighting).

- To switch it back on, press the On/Off  control or the lighting control .

This hood operates in a very efficient and energy-saving manner. The following will help you to save even more energy when using it:

- Ensure that there is sufficient ventilation in the kitchen when cooking. If there is insufficient air flow during extraction mode, the hood cannot operate efficiently, causing increased operating noise levels.
- Always cook with the lowest possible setting. This produces fewer cooking vapors so that you can use a lower hood power level and therefore benefit from reduced energy consumption.
- Clean or change the filters at regular intervals. Heavily soiled filters reduce performance, increase the risk of fire and are unhygienic.
- Use the Con@ctivity function. The ventilation hood will switch on and off automatically. The ventilation hood will select the optimum power level for the cooking you are doing, which ensures low energy consumption.
- If you are operating the ventilation hood manually, please note the following:
 - Check the power level selected on the ventilation hood. A low power level is usually sufficient. Only use the Booster setting when necessary.
 - When a large volume of cooking vapors are being produced, switch to a high power level in good time. This is more efficient than operating the hood for longer to try to capture cooking vapors that have already been distributed throughout the kitchen.
 - Make sure that you switch off the hood after use. If cooking vapors and odors still need to be removed from the kitchen air after cooking, use the delayed shutdown function. The blower will switch off automatically after the selected delayed shutdown time.



Changing settings

Adjusting the grease filter filter saturation indicator

The filter saturation indicator can be set to suit the customer's cooking habits.

The factory default setting is a cleaning interval of 30 hours.

- Select a shorter interval of 20 hours if food is fried regularly.
- A shorter cleaning interval is also recommended if the customer only cooks occasionally. This will prevent grease buildup from hardening and making cleaning more difficult.
- Select a longer cleaning interval of 40 or 50 hours if the customer uses very little fat when cooking.

- Switch off the blower and the lighting.
- Press the delayed shutdown control  and the filter saturation control  at the same time.

The grease filter symbol  and one of the blower power level indicators will flash.

The indicators **1** to **B** show the current time setting:

1	20 hours
2	30 hours
3	40 hours
B	50 hours

- Press the **—** control for a shorter duration, or **+** for a longer duration.
- Confirm the selection by pressing the filter saturation indicator .

All the indicator lights will go out.

If the new setting is not confirmed within 4 minutes, the ventilation hood will revert to the previous setting.



Adjusting or deactivating the filter saturation indicator for the charcoal filter

Charcoal filters are needed for recirculation mode.

The filter saturation indicator can be set to suit the customer's cooking habits.

It has to be deactivated for extraction mode.



The factory default setting is an interval of 180 hours.

- Switch off the blower and the lighting.
- Press the “+” button and the operating-hours button   at the same time.

The charcoal filter symbol  and one of the blower power level indicators will flash.

The indicators **1** to **B** show the current time setting:

Indicator 1	120 hours
Indicator 2	180 hours
Indicator 3	240 hours
B	Deactivated

- Press the “+” or “-” button to select the required duration.
- Confirm the selection by pressing the operating-hours button  .



All the indicator lights will go out.

If the selection is not confirmed within 4 minutes, the system will revert to the previous setting.

Deactivating power management

Keep in mind that this may increase energy consumption.

Activating/deactivating power management

- Switch off the blower and the lighting.
- Press the delayed shutdown control ⁵ for approx. 10 seconds until the **1** indicator appears in the blower level display.
- Then press, in turn:
 - the lighting control ,
 - the — control, and then
 - the lighting control .

When power management is turned on, the **1** and **B** indicators will be continuously lit.

When it is turned off, the **1** and **B** indicators will flash.

- Press the — control to deactivate power management.
- The **1** and **B** indicators will flash.
- Press the + control to activate power management.

The **1** and **B** indicators will be continuously lit.

- Confirm the setting by pressing the delayed shutdown control ⁵ for approx. 10 seconds.

All the indicator lights will go out.

If you do not confirm the new setting within 4 minutes, the ventilation hood will revert to the previous setting.

Cleaning and care

 Before proceeding with any maintenance or cleaning task, the ventilation hood must be disconnected from the power supply, see “IMPORTANT SAFETY INSTRUCTIONS”.

Stainless steel housing

General information

Unsuitable cleaning agents can damage the surfaces and control elements.

Do not use any cleaning agents containing soda, acid, chloride, or solvent.

Do not use any abrasive cleaning agents, e.g., powder cleaners or cream cleaners and abrasive sponges, as well as pot scourers or sponges which have been used previously with abrasive cleaning agents

 Moisture in the ventilation hood can cause damage.
Make sure that water does not get into the ventilation hood.

- Clean all surfaces and control buttons using a small amount of warm water and liquid dish soap. Apply with a sponge cloth.
- After cleaning, wipe the surfaces dry using a soft cloth.

Important information for appliances with stainless steel surfaces

This information does not apply to the control buttons.

Stainless steel surfaces can be cleaned with a non-abrasive cleaning agent designed specifically for use on stainless steel.

To prevent the surfaces from quickly becoming dirty again, we recommend treating them with a stainless steel care product (available from Miele).

Important information for the controls



If soiling is not removed promptly, it could cause the control elements to alter or discolor.
Remove soiling immediately.

The surface of the control elements can become damaged if they are cleaned using stainless steel cleaning agents.

Do not use stainless steel cleaning agents on the control elements.

Filter saturation indicator





The ventilation hood registers the length of time it has been operated.

Filter saturation indicators show when the filters need to be cleaned or changed by lighting up the grease filter symbol  or charcoal filter symbol .

You can set the filter saturation indicator to suit the type of cooking you do (see “Changing settings”).

Checking the filter saturation indicator

Before the set operating time has run out, you can check what percentage of the time has elapsed.

- Press the On/Off control  to turn the blower on.
 - Press and hold the filter saturation indicator  .
- Once, to check the grease filter operating time. The grease filter symbol  lights up.
- Twice, to check the charcoal filter operating time. The charcoal filter symbol  lights up.

One or more of the blower power level indicators will flash simultaneously.

The number of flashing indicators shows the elapsed operating time as a percentage.

Indicator 1	25%
Indicators 1 and 2	50%
Indicators 1 to 3	75%
Indicators 1 to B	100%

The number of elapsed operating hours remains stored in memory when the ventilation hood is turned off or if there is a power outage.

Grease filter

 Risk of fire

An oversaturated grease filter is a fire hazard.

Clean the grease filter at regular intervals.

The re-usable metal grease filter in the appliance removes solid particles from the kitchen vapors (grease, dust, etc.), preventing soiling of the ventilation hood.

The grease filter must be cleaned at regular intervals.

A heavily soiled grease filter hinders air extraction and will lead to increased levels of soiling in the ventilation hood and in the kitchen.

Cleaning intervals

Accumulated grease solidifies over a longer period of time and makes cleaning more difficult. The grease filter should therefore be cleaned at least every 3 to 4 weeks.

The filter saturation indicator reminds you to regularly clean the grease filter by illuminating the grease filter symbol .

Cleaning and care

Removing the grease filters

 When handling the grease filter, be careful not to drop it. This can result in damage to the filter and the cooktop below. Make sure you hold the filter securely at all times when handling it.

- Pull out the deflector plate.

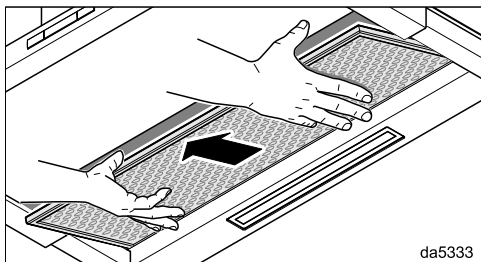
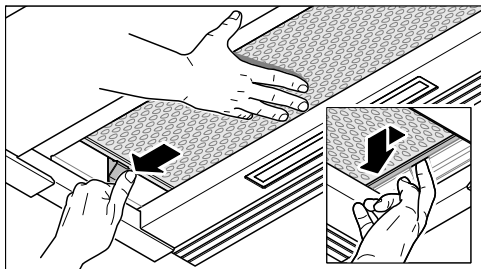

- Support the grease filter with your right hand. Press down on the lock on the left-hand side. The filter slides down.
- Push the grease filter from the right-hand side slightly to the left.
- Pull the grease filter down to remove it.

Cleaning the grease filter in the dishwasher

 Risk of damage due to excessively high temperatures in the dishwasher.

Excessively high temperatures can render the grease filter unusable (due to being warped out of shape, for example).

Select a program that does not exceed the recommended temperature.

Also follow the information provided in the operating instructions for the dishwasher.

- Place the grease filter upright or slightly inclined in the lower basket. Ensure the spray arm is not obstructed.
- Use a standard household cleaning agent.
- Select a program with a maximum wash temperature of 150°F (65°C).

Depending on the cleaning agent used, the internal filter surfaces may become discolored. However, this will not affect the functioning of the grease filters in any way.

Unsuitable cleaning agents

Unsuitable cleaners can cause damage to the filter surfaces if used regularly. Do not use any of the following:

- Lime removers
- Abrasive powders or abrasive liquids
- Aggressive all-purpose cleaners and degreaser sprays
- Oven sprays

Cleaning the grease filter in a dishwasher

- Place the grease filter upright or slightly inclined in the lower basket. Ensure the spray arm is not obstructed.
- Use a commonly available household dishwashing detergent.
- In a Miele dishwasher use the "Normal" program.

Depending on the detergent used, cleaning the filter in a dishwasher may cause the inside filter surfaces to become discolored. However, this will not affect the functioning of the grease filter in any way.

After cleaning

- After cleaning, leave the filters on an absorbent surface to dry.
- When removing the filter for cleaning, also clean off any residues of oil or fat from the now accessible casing to prevent the risk of these catching fire.

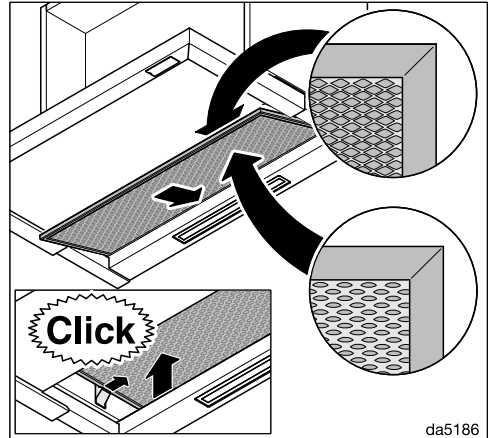



- Reinsert the grease filter.

Cleaning and care



Resetting the filter saturation indicator for the grease filter

Once cleaning is complete, the filter saturation indicator must be reset.

- While the fan is turned on, press the filter saturation indicator   for approx. 3 seconds until **1** is the only indicator flashing.

The grease filter symbol  goes out.

When cleaning the grease filter before the full operating time has elapsed:

- Press the filter saturation indicator   for approx. 6 seconds until **1** is the only indicator flashing.

Replacing the grease filter

Regular usage and cleaning can cause the filter surfaces to become worn.

If you identify any damage, replace the grease filter.

Grease filters are available to order via Miele Customer Service (see end of these operating instructions for contact details) or from your Miele dealer.

OdorFree Charcoal Filter

With recirculation mode, two charcoal filters must be inserted in addition to the grease filter. These are designed to absorb cooking odors.

The charcoal filters are fitted in the canopy above the grease filter.

Charcoal filters are available to order via the Miele website or from your Miele dealer.

The charcoal filters are listed under “Technical data” at the back of this booklet.

Installing/replacing the charcoal filters

The matching frames must be installed in order to use the charcoal filter. Follow the directions on the installation sheet.

- Remove the grease filter from the ventilation hood.
- Remove the charcoal filter packaging.

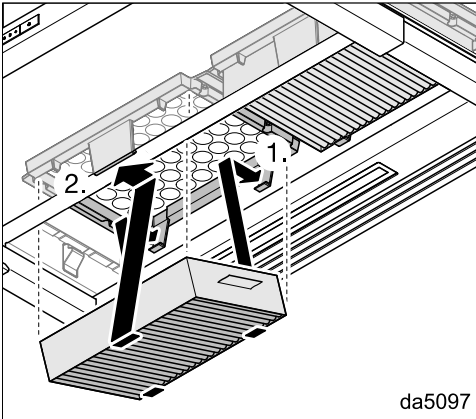

- Push the charcoal filters into the frames until they engage firmly.
- Reinsert the grease filter.
- To remove the charcoal filters, press the holder clip forward slightly and pull the filters down to remove them.

When to change the OdorFree Charcoal Filter

Replace the charcoal filters when they no longer absorb kitchen odors effectively, and at least every 6 months.

The filter saturation indicator reminds you to regularly replace the charcoal filters by illuminating the charcoal filter symbol ☉.

Resetting the filter saturation indicator for the charcoal filters

After changing the charcoal filters, the filter saturation indicator must be reset.

- To do this, press the filter saturation indicator ☉☉ twice with the blower turned on and hold it for approx. 3 seconds until **1** is the only indicator flashing.

The charcoal filter symbol ☉ will go out.

If you want to replace the charcoal filters **before** the full operating time elapses:

- Press the filter saturation indicator ☉☉ twice and hold it for approx. 6 seconds until **1** is the only indicator flashing.

Disposing of charcoal filters

- Used charcoal filters can be disposed of with normal household waste.

Reactivatable charcoal filters

Reactivatable charcoal filters are available for this ventilation hood. They can be used several times after being reactivated in the oven.

Please follow the operating instructions supplied with the filters.

Installation

Before installation

 Before installation, it is important to read the information contained in this chapter and in the “IMPORTANT SAFETY INSTRUCTIONS” chapter.

Information is subject to change. Please refer to our website to obtain the most current product specification, technical & warranty information.

Installation recommendations

- To achieve optimum vapor extraction, the hood must be centered over the cooktop, not to the side.
- The cooktop should be no wider than the hood. Preferably, it should be narrower for better extraction.
- The mounting area must be easily accessible. The ventilation hood should be easy to reach and disassemble in case a service call is necessary. This should be taken into consideration when planning the position of cabinetry, shelves, ceilings or decorative elements in the vicinity of the ventilation hood.

Installation materials



1 non-return flap
for installation in the exhaust vent on the motor (not needed for recirculation mode)

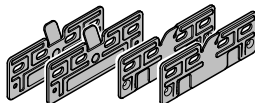

4 mounting plates
for installation in a 23 ⁵/₈" (600 mm) wide cabinet

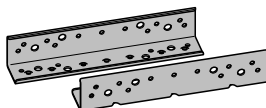

2 brackets
for installation in a 35 ⁷/₁₆" (900 mm) wide cabinet (only for 35 ¹/₄" (896 mm) wide appliances)

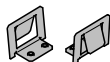

2 spring clips
for installation in a 35 ⁷/₁₆" (900 mm) wide cabinet (only for 35 ¹/₄" (896 mm) wide appliances)

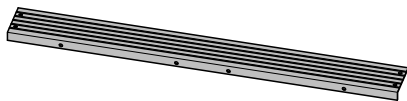

1 spacer strip
for concealing the gap between the rear of the appliance and the wall

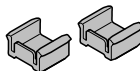

2 depth stops
to limit how far the canopy can be pushed in

08169470

11574700

08268021

08383320

11597850

11940470



4 screws, M4 x 8 mm



5 (9)* screws, 4 x 15 mm

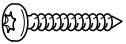

4 screws, 4 x 30 mm



8 (12)* screws, 4 x 15 mm



4 screws, M4 x 12 mm*



4 screws, M4 x 8.5 mm*



2 screws, 3.9 x 7.5 mm with cover caps

* For 35 1/4" (896 mm) wide appliances

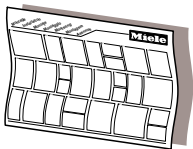

Installation plan

See the installation plan for details of the individual steps involved in the installation of this appliance.

Leave these instructions with the appliance for the consumer/user.

08095672

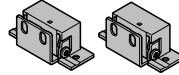

01056271

DML 2000 installation kit

for installing a hinged front panel to match kitchen cabinetry (not supplied; available as an optional accessory)

08879120

Installation materials for recirculation mode

You need the following optional accessories for recirculation mode.

04932511

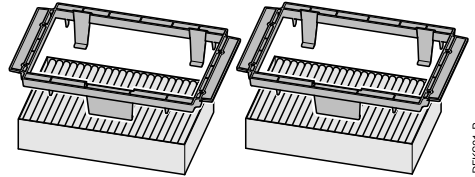

07270730

DKFS 31-x installation kit

contains 2 holders and 2 charcoal filters (DKFS 31-900 P with single-use charcoal filters or DKFS 31-R with reactivatable charcoal filters)

06462181

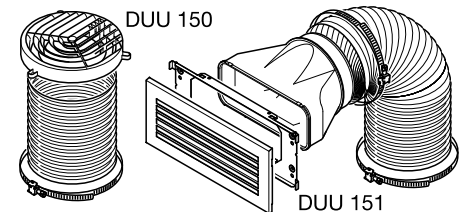

1880mkap

dina3mle

DUU 15x installation kit

contains a directional unit socket, hose, and hose clips (DUU 150 for the top of the cabinet or DUU 151 for the sides or front of the cabinet).

11839870

DFKS31-P

DUU 150 151

Installation

Appliance dimensions

Diagram 1:

DAS 4720 in a 23 5/8" (600 mm) wide cabinet.

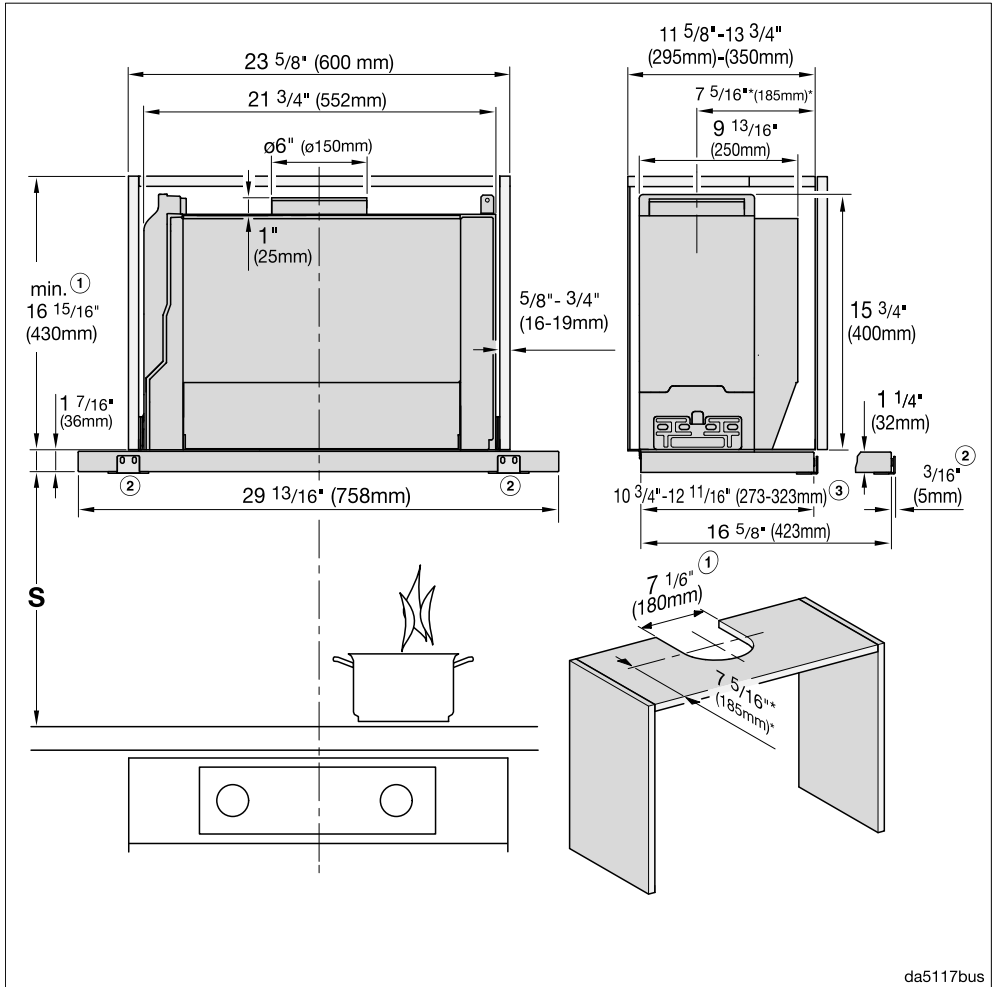

The drawing is not to scale.

Diagram 2:

DAS 4720 in a 30" (762 mm) wide cabinet

DAS 4920 in a 35 7/16" (900 mm) wide cabinet

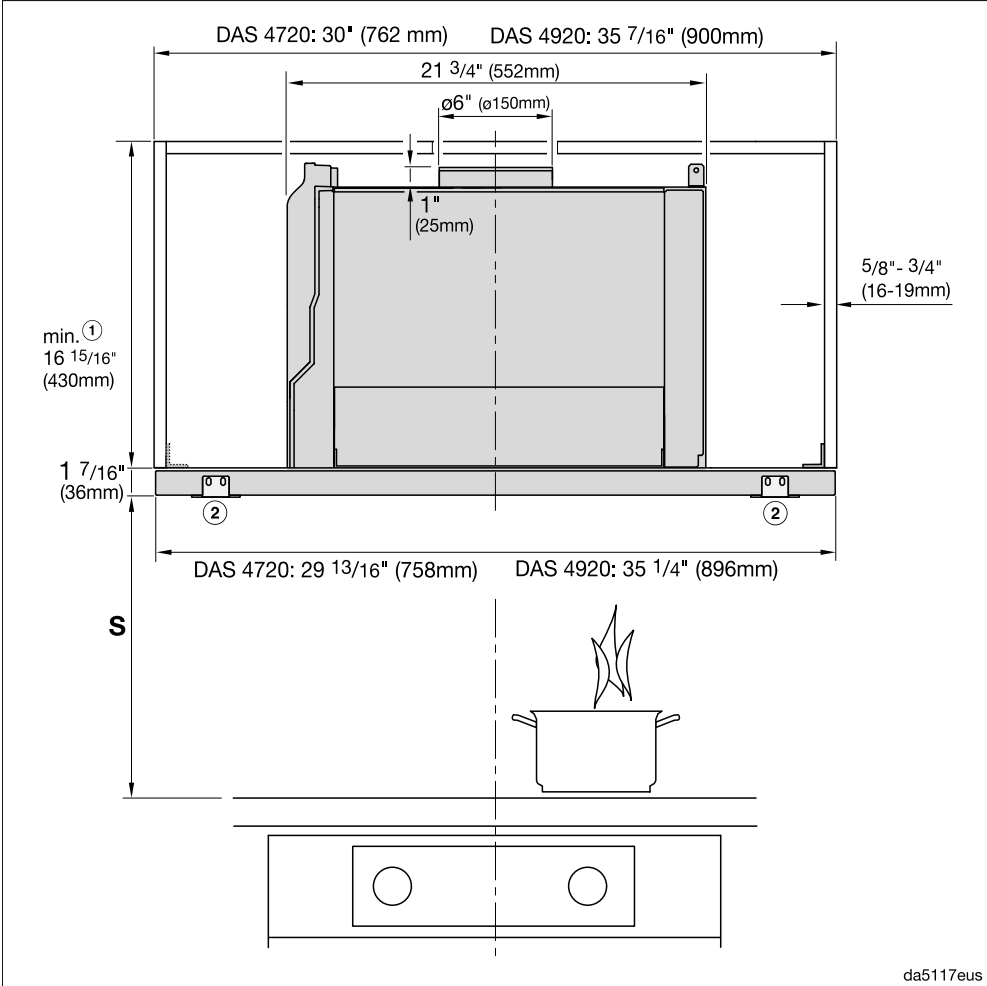

The drawing is not to scale.

See diagram 1 for side view.

Installation

Diagram 3:

DAS 4920 in a 23 5/8" (600 mm) wide cabinet or in a 35 7/16" (900 mm) wide cabinet with side compartments

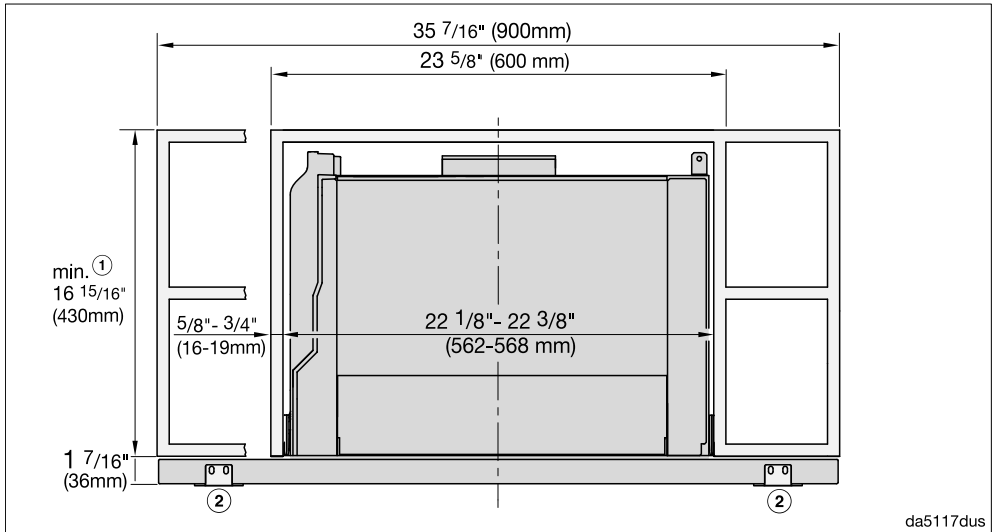

The drawing is not to scale.

See diagram 1 for side view.

Footnotes for diagrams 1 to 3:

- ① Vented or recirculation with DUU 150 conversion kit
- ② DML 2000 bracket (accessory) for installing a front panel
- ③ Can be adjusted via depth stop

* In this installation situation, the deflector plate is flush with the front edge of the cabinet niche. If you wish to position the ventilation hood further forward or further back, you must adapt the dimensions accordingly (e.g., if you are using a front panel).

The height of the cabinet and the cut-out dimensions must take into account any accessories installed.

Distance between cooktop and ventilation hood (S)

Provided a larger distance is not given by the manufacturer of the cooktop, follow the minimum safety distances between a cooktop and the bottom of the hood.

Please also observe the information contained in the “IMPORTANT SAFETY INSTRUCTIONS” section.

Cooking appliance	Minimum distance S	
	Miele appliance	Non-Miele appliance
Electric Cooktops	24" (610 mm)	
Electric Barbeques and Fryers	26" (660 mm)	
Multiburner Gas Cooktops ≤ 43,000 BTU/hr (12.6 kW), no burner > 15,000 BTU/hr (4.5 kW).	26" (660 mm)	30" (760 mm)
Multiburner Gas Cooktops ≤ 73,800 BTU/hr (21.6 kW), no burner > 16,500 BTU/hr (4.8 kW)	30" (760 mm)	
Multiburner Gas Cooktops > 73,800 BTU/hr (21.6 kW), or one of the burners > 16,500 BTU/hr (4.8 kW)	Not possible	
Single Burner Gas Cooktops ≤ 20,500 BTU/hr (6 kW)	26" (660 mm)	30" (760 mm)
Single Burner Gas Cooktops > 20,500 BTU/hr (6 kW) ≤ 27,600 BTU/hr (8.1 kW)	30" (760 mm)	
Single Burner Gas Cooktops > 27,600 BTU/hr (8.1 kW)	Not possible	

If you are installing a front panel made of wood or plastic to the hood, observe the safety distances given by the cooktop manufacturer regarding the use of easily flammable materials.

Installation

Installing the depth stop (optional)

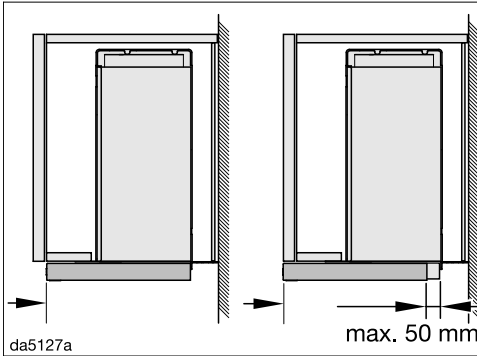

You can limit how far the deflector plate can be pushed in.

For example, if the deflector plate should sit flush with the front edge of the cabinet door when pushed in, rather than with the front edge of the cabinet housing, you can position the depth stop accordingly.

You can move the stop forward by up to 2" (50 mm).

You must insert the depth stops into the recesses of the deflector plate prior to installing the ventilation hood. You can fix the depth stops in the required position on completion of installation.

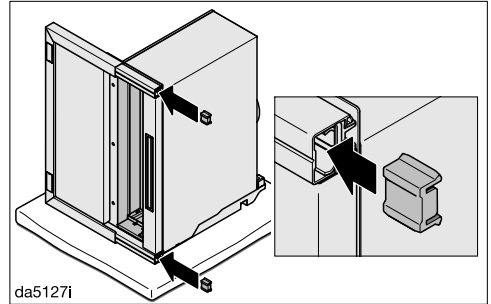

- Insert the depth stops into the recesses of the deflector plate from behind. The lip on the depth stop faces backward.

- Install the ventilation hood.

- Pull out the deflector plate.

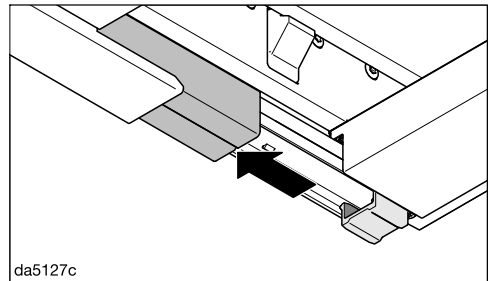

- Slide the recess covers forward.

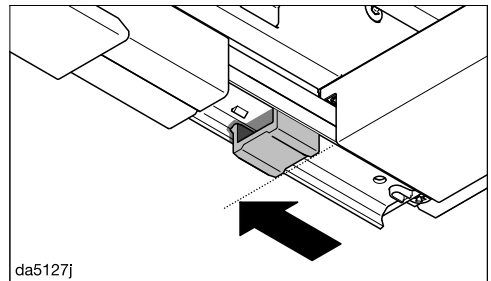

- Slide the depth stops forward to the position shown.

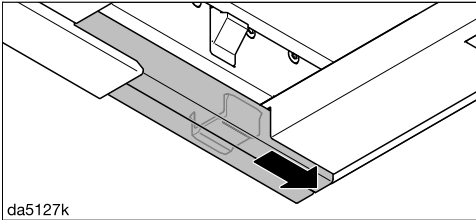

- Slide the covers back again.

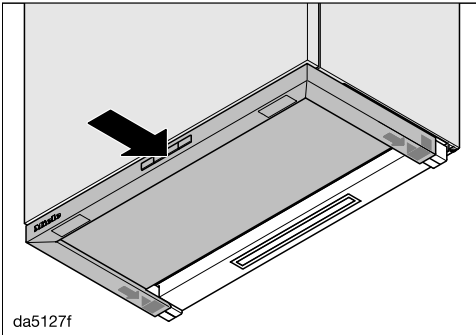

- Carefully push in the deflector plate as far as the required position.

This will push the depth stops into the required position.

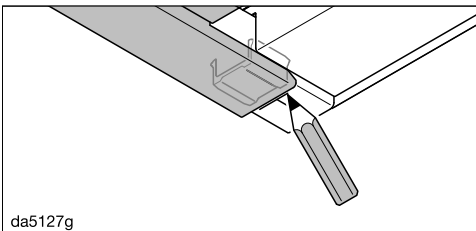

- Use a pen to mark the back edge of the deflector plate on the cover.
- Pull out the deflector plate.

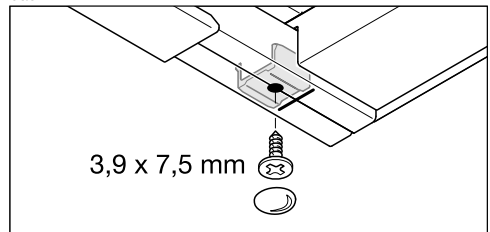
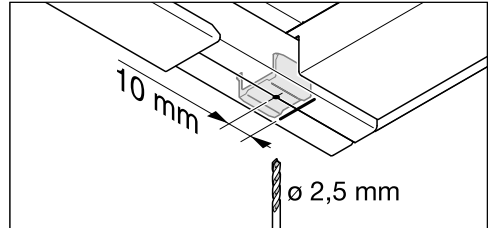

- Drill a pilot hole 3/8" (10 mm) in front of the pen mark and screw the depth stop into place.

Installation

Air venting

WARNING: Danger of toxic fumes. Gas cooking appliances release carbon monoxide that can be harmful or fatal if inhaled.

To reduce the risk of fire and to properly exhaust air, the exhaust gases extracted by the hood should be vented outside of the building only. Do not vent exhaust air into spaces within walls or ceilings or in attics, crawl spaces or garages.

To reduce the risk of fire, only use metal ductwork.

Please read and follow the "IMPORTANT SAFETY INSTRUCTIONS" to reduce the risk of personal injury. Follow all local building codes when installing the hood.

Only use smooth pipes or flexible ducting made from approved non-flammable materials for ducting.

To achieve the most efficient air throughput with the lowest noise levels, please note the following:

- The diameter of the vent ducting must not be smaller than the cross-section of the vent collar (see "Appliance dimensions"). This applies in particular when using flat ducting.
- The ducting should be as short and straight as possible.
- Only use wide radius bends.
- The ducting must not be kinked or compressed.
- All connections must be strong and airtight.
- If the ducting has flaps, these must be opened whenever the ventilation hood is switched on.

Any constriction of the air throughput will reduce extraction performance and increase operating noise.

Ventilation stack

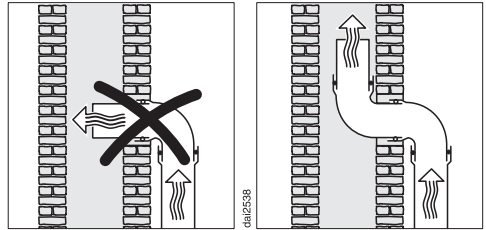

If the exhaust air is to be ducted into a flue, the ducting must be directed in the flow direction of the flue.

If the flue is used by several ventilation units, the cross-section of the flue must be large enough.

Non-return flap

- Use a non-return flap in the vent system.

A non-return flap ensures that when the ventilation hood is not in operation, the duct is closed to prevent unwanted exchange of room air and outside air.

If the exhaust is ducted through an outside wall, a Miele wall vent or roof vent (available as an optional accessory) is recommended. Both of these have a built-in non-return flap.

If the on-site vent system does not have a non-return flap, one is supplied with the ventilation hood.

The non-return flap is installed in the exhaust socket of the fan.

Condensate

If the ducting is to run through cool rooms or ceiling space, for example, the significant variations in temperature between the different areas can cause condensate to form. Insulate the ducting to reduce temperature variations.

If the ducting is to be laid horizontally, it must be laid with a downwards sloping gradient of at least $\frac{3}{8}$ " (1 cm) per meter. This is to ensure that condensate cannot drain back into the ventilation hood.

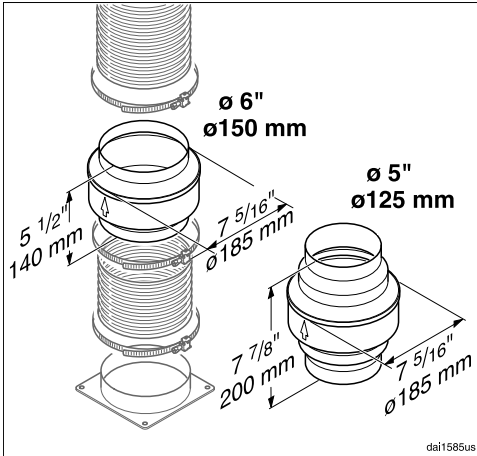

In addition to insulating the ducting, it is advisable to also install a condensate trap for collecting and evaporating any potential condensate.

Condensate traps for 5" (125 mm) or 6" (150 mm) diameter ducting are available as optional accessories.

When installing a condensate trap, ensure that it is positioned vertically and as closely as possible to the ventilation hood above the exhaust vent. The arrow on the casing indicates the direction of airflow.

Miele will not accept warranty claims for any functional defects or damage caused by inadequate ducting.

Reducing Collar

(optional accessory)

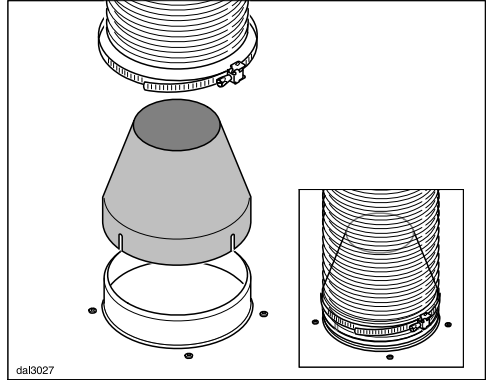

If you would like to reduce the environmental impact of your ventilation system by limiting the CFM output the Reducing Collar can be installed. It reduces the air flow to less than 400 CFM. Check local building codes for max. CFM requirements.

- Push the Reducing Collar on the exhaust port of the blower.
- Push the exhaust hose over it.
- Secure both with a hose clamp.

Installation

Electrical connection

WARNING: TO REDUCE THE RISK OF FIRE, ELECTRIC SHOCK, OR INJURY TO PERSONS, OBSERVE THE FOLLOWING:

All electrical work should be performed by a qualified electrician in strict accordance with national regulations (for USA: ANSI-NFPA 70) and local safety regulations. Installation, repairs and other work by unqualified persons could be dangerous.

Ensure that power to the appliance is OFF while installation or repair work is performed.

Verify that the voltage, load and circuit rating information found on the data plate (see "Technical Service"), match the household electrical supply before installing the hood.

Use only with ventilation hood cord-connection kits that have been investigated and found acceptable for use with this model hood.

If there is any question concerning the electrical connection of this appliance to your power supply, please consult a licensed electrician or call Miele's Technical Service Department.

WARNING: THIS APPLIANCE MUST BE GROUNDED

Grounding Instructions

WARNING - Improper grounding can result in a risk of electric shock.

This appliance must be grounded. In the event of an electrical short circuit, grounding reduces the risk of electric shock by providing a path of least resistance. This appliance is equipped with a cord having a grounding wire with a grounding plug.

If there is any doubt, have the electrical system of the house checked by a qualified electrician.

Do not use an extension cord. If the power supply cord is too short, have a qualified electrician install an outlet near the appliance.

- The plug must be plugged into an outlet that is properly installed and grounded.

WARNING - Grounding instructions (Canada)

The grounding-type attachment plug shall be connected to a grounding-type receptacle installed in accordance with CSA C22.1-12, Canadian Electrical Code, Part I.

Information to help you rectify faults yourself and about Miele spare parts can be found at www.miele.com/service.

Contact in the event of a fault

In the event of a fault which you cannot remedy yourself, please contact your Miele dealer or Miele Customer Service.

You can book a Miele Service Call online at www.miele.com/service.
Contact information for Miele Customer Service can be found at the end of this document.

Please quote the model identifier and serial number of your appliance (SN) when contacting Miele Customer Service. Both pieces of information can be found on the data plate.

Location of the data plate

The data plate is visible once you have removed the grease filter and, in the case of recirculation mode, the charcoal filter.

Appliance warranty and product registration

You can register your product and/or view the manufacturer's warranty terms and conditions for Miele appliances and vacuum cleaners at www.mieleusa.com.

Technical data

Fan motor	350 W
Overhead lighting	3 W
Total connected load	353 W
Supply voltage, frequency	120 V AC, 60 Hz
Fuse rating	15 A
Power cord length	2.5 ft (0.75 m)
Weight	
DAS 4720	35.3 lbs (16 kg)
DAS 4920	37.5 lbs (17 kg)

WiFi module

Frequency range	2.400–2.4835 GHz
Maximum transmission power	< 100 mW

Optional accessories for recirculation mode

You need the following installation kits for recirculation mode:

- DUU 150 or DUU 151
- DKFS 31-900 P or DKFS 31-R (reactivable). The installation kits contain 2 charcoal filters and the required original equipment installation frames.

Charcoal filters DKF 31-900 P or DKF 31-R (reactivable) must be purchased as an optional accessory. The packs contain 2 charcoal filters.



WiFi module EK037

FCC ID: 2ACUWEK037

IC: 5669C-EK037

This device complies with Part 15 of the FCC Rules and with Industry Canada licence-exempt RSS standard(s). Operation is subject to the following two conditions: (1) this device may not cause harmful interference, and (2) this device must accept any interference received, including interference that may cause undesired operation.

Please have the model and serial number of your appliance available when contacting Customer Service.

U.S.A.

Miele, Inc.

National Headquarters

9 Independence Way
Princeton, NJ 08540
www.mieleusa.com

Customer Support

Phone: 888-99-MIELE (64353)
info@mieleusa.com

International Headquarters

Miele & Cie. KG
Carl-Miele-Straße 29
33332 Gütersloh
Germany

Canada

Importer
Miele Limited

Headquarters and Miele Centre

161 Four Valley Drive
Vaughan, ON L4K 4V8
www.miele.ca

Customer Care Centre

Phone: 1-800-565-6435
905-532-2272
customercare@miele.ca

DAS 4720, DAS 4920

en-US

M.-Nr. 12 311 900 / 04