

Operating and installation instructions Induction cooktops



It is **essential** to read these operating and installation instructions before installing and using the appliance. This prevents both personal injury and damage to the appliance.

Warning and Safety instructions	5
Caring for the environment	16
Overview	17
Cooktop	17
Controls and display	18
Before using for the first time	19
Cleaning the cooktop for the first time	19
Switching on the cooktop for the first time	19
Miele@home	20
Con@ctivity	23
How it works	26
Cookware	27
Tips on saving energy	29
Power level range	30
Operation	31
Operating principles	31
Positioning cookware	32
Switching on the cooktop	33
Setting the power level	33
Switching the cooktop off	33
Residual heat indicator	33
Setting the power level – extended power level range	33
Auto heat-up	34
Booster	35
Keeping warm	36
Timer	37
Minute minder	37
Auto switch-off	38
Using both timer functions at the same time	39
Additional functions	40
Stop & Go	40
Recall	40
Wipe protection	41
Demonstration/Showroom mode	41
Displaying cooktop data	42

Contents

Safety features	43
System lock/Safety lock.....	43
Safety switch-off	44
Overheating protection.....	45
Programming	46
Cleaning and care	50
Problem solving guide	52
Messages in the display.....	52
Unexpected behaviour	54
Unsatisfactory results.....	55
General problems or technical faults.....	56
Optional accessories	57
Service	58
Contact in case of fault	58
Data plate	58
Warranty	58
Installation	59
Safety instructions for installation	59
Safety distances.....	60
Installation notes – surface-mounted.....	63
Installation dimensions – Surface-mounted	64
KM 7678-2 FL, KM 7878-2 FL Diamond	64
KM 7897-2 FL Diamond	65
Surface-mounted installation	66
Installation notes – flush-fit	67
Installation dimensions – Flush-fit	68
KM 7678-2 FL, KM 7878-2 FL Diamond	68
KM 7897-2 FL Diamond	69
Flush-fit installation	70
Electrical connection	71

Warning and Safety instructions

This cooktop complies with all relevant local and national safety requirements. However, inappropriate use can lead to personal injury and damage to property.

Read the operating and installation instructions carefully before using the cooktop. They contain important information on safety, installation, use and maintenance of the appliance. This prevents both personal injury and damage to the cooktop.

In accordance with standard IEC 60335-1, Miele expressly and strongly advises that you read and follow the instructions in “Installation”, as well as in the “Warning and Safety instructions”.

Miele cannot be held liable for injury or damage caused by non-compliance with these instructions.

Keep these instructions in a safe place and pass them on to any future owner.

Warning and Safety instructions

Correct application

- ▶ This cooktop is designed for domestic use and for use in similar environments by guests in hotel or motel rooms, bed & breakfasts and other typical living quarters. This does not include common/shared facilities or commercial facilities within hotels, motels or bed & breakfasts.
- ▶ This cooktop is not suitable for outdoor use.
- ▶ It is intended only to cook food and keep it warm. Any other use is not supported by Miele and could be dangerous.
- ▶ This cooktop is not intended for use by people (including children) with reduced physical, sensory or mental capabilities or lack of experience and knowledge, unless they have been given supervision and instruction concerning its use by a person responsible for their safety. They may only use the cooktop unsupervised if they have been shown how to use it in a safe way. They must be able to recognise and understand the potential dangers of improper use.

Safety with children

- ▶ Young children must not be allowed to use this appliance.
- ▶ Older children may only use the appliance if its operation has been clearly explained to them and they are able to use it safely. They must be aware of the potential dangers caused by incorrect operation.
- ▶ Cleaning may only be carried out by older children under the supervision of an adult.
- ▶ Please supervise children in the vicinity of the cooktop and do not let them play with it.
- ▶ The cooktop gets hot when in use and remains hot for a while after being switched off. Keep children well away from the cooktop until it has cooled down and there is no danger of burning.
- ▶ Danger of burning! Do not store anything which might arouse a child's interest in storage areas above or behind the cooktop. Otherwise children could be tempted to climb onto the cooktop with the risk of burning themselves.
- ▶ Danger of burning and scalding! Turn the handles of pots and pans on the cooktop to the side or the rear so that children cannot pull them down and burn themselves.
- ▶ Danger of suffocation! Whilst playing, children may become entangled in packaging material (such as plastic wrapping) or pull it over their head with the risk of suffocation. Keep packaging material away from children.
- ▶ Activate the system lock to ensure that children cannot switch on the cooktop inadvertently. Use the safety lock when the cooktop is in use to prevent children from altering the settings selected.

Warning and Safety instructions

Technical safety

- ▶ Unauthorised installation, maintenance and repairs (including removal of any cover) can cause considerable danger for the user. Installation, maintenance and repairs must only be carried out by a Miele authorised technician.
- ▶ Damage to the cooktop can compromise your safety. Check the appliance for visible signs of damage. Do not use the cooktop if it is damaged.
- ▶ Temporary or permanent operation with a self-sufficient or non-mains synchronous energy supply system (e.g. isolated networks, back-up systems) is possible. A requirement for the operation is that the energy supply system complies with all current local and national requirements that apply to stand-alone, solar and/or battery systems.
The protective measures provided in the installation and in this Miele product must also be assured in their function and operation in isolated operation or in non-mains synchronous operation, or replaced with equivalent measures in the installation.
- ▶ The electrical safety of this appliance can only be guaranteed when continuity is complete between it and an effective earthing system which complies with local and national safety regulations. It is most important that this basic safety requirement is present and tested regularly and, where there is any doubt, the household wiring system should be inspected by a qualified electrician.
- ▶ Before connecting the appliance to the mains electricity supply, ensure that the connection data on the data plate (voltage and frequency) matches the mains electricity supply. This data must correspond in order to avoid the risk of damage to the appliance.
- ▶ Do not connect the cooktop to the mains electricity supply by a multi-socket adapter or extension lead. These are a fire hazard and do not guarantee the required safety of the appliance.

Warning and Safety instructions

- ▶ For safety reasons, this cooktop may only be used after it has been built in.
- ▶ This appliance must not be installed and operated in mobile installations (e.g. on a ship).
- ▶ Never open the casing of the cooktop.
Touching or tampering with electrical connections or components and mechanical parts is highly dangerous to the user and can cause operational faults.
- ▶ The manufacturer's warranty will be invalidated if the appliance is not repaired by a Miele authorised service technician.
- ▶ Faulty components must only be replaced by genuine Miele spare parts. The manufacturer can only guarantee the safety of the appliance when Miele replacement parts are used.
- ▶ The cooktop is not intended for use with an external timer switch or a remote control system.
- ▶ The cooktop must be connected to the electricity supply by a qualified electrician (see “Installation – Electrical connection”).
- ▶ If the mains connection cable is damaged, it must be replaced with a special mains connection cable by a qualified and competent electrician in order to avoid a hazard (see “Installation - Electrical connection”).
- ▶ During installation, maintenance and repair work, the appliance must be disconnected from the mains electricity supply. It is only completely isolated from the electricity supply when:
 - the mains circuit breaker is switched off, or
 - it is switched off at the wall socket and the plug is withdrawn from the socket. Do not pull the mains connection cable but the mains plug to disconnect your appliance from the mains electricity supply.

Warning and Safety instructions

- ▶ Danger of electric shock! If the ceramic surface is faulty, cracked, chipped or damaged in any way, do not use the cooktop and switch it off immediately. Disconnect the cooktop from the electricity supply. Contact Miele.
- ▶ If the cooktop is installed behind a furniture door, do not close the door while the cooktop is in operation. Heat and moisture can build up behind the closed door. This can result in damage to the cooktop, the housing unit and the floor. Do not close the door until the appliance has cooled down and the residual heat indicators have gone out.
- ▶ In areas which may be subject to infestation by cockroaches or other vermin, pay particular attention to keeping the appliance and its surroundings clean at all times. Any damage caused by cockroaches or other vermin will not be covered by the warranty.
- ▶ DO NOT MODIFY THIS APPLIANCE.

Correct use

- ▶ The cooktop gets hot when in use and remains hot for a while after being switched off. There is a danger of burning until the residual heat indicators go out.
- ▶ Oil and fat can overheat and catch fire. Do not leave the cooktop unattended when cooking with oil and fat. If it does ignite, do not attempt to put the flames out with water. Switch off the cooktop and use a suitable fire blanket, saucepan lid, damp towel or similar to smother the flames.
- ▶ The cooking process has to be supervised. A short term cooking process has to be supervised continuously.
- ▶ Flames could set the grease filters of a rangehood on fire. Do not flambé under a rangehood.
- ▶ Spray canisters, aerosols and other inflammable substances can ignite when heated. Therefore do not store such items or substances in a drawer under the cooktop. Cutlery inserts must be heat-resistant.
- ▶ Do not heat an empty pan.
- ▶ Do not heat up food in closed containers e.g. tins or sealed jars on the cooktop, as pressure can build up in the containers, causing them to explode.
- ▶ Do not cover the cooktop, e.g. with a cooktop cover, a cloth or protective foil. The material could catch fire, shatter or melt if the cooktop is switched on by mistake or if residual heat is still present.

Warning and Safety instructions

- ▶ When the cooktop is switched on, either deliberately or by mistake, or when there is residual heat present, there is a risk of metal items placed on the cooktop heating up. Depending on the material, other items left on the appliance could also melt or catch fire. Damp pan lids might adhere to the ceramic surface and be difficult to dislodge. Do not use the cooktop as a resting place for anything else. Switch the cooktop off after use and do not rely on the pan detector.
- ▶ You could burn yourself on the hot cooktop. Protect your hands with heat-resistant pot holders or oven gloves when handling hot pots and pans. Do not let them get wet or damp, as this causes heat to transfer through the material more quickly with the risk of scalding or burning yourself.
- ▶ When using an electrical appliance, e.g. a hand-held food mixer, near the cooktop, ensure that the cable of the electrical appliance cannot come into contact with the hot cooktop. The insulation on the cable could become damaged.
- ▶ Grains of salt, sugar and sand (e.g. from cleaning vegetables) can cause scratches if they get under pan bases. Make sure that the ceramic surface is clean before placing pans on it.
- ▶ Even a light object can cause damage in certain circumstances. Do not drop anything on the ceramic surface.
- ▶ Placing hot pans on the sensors and indicators could damage the electronics underneath. Do not place hot pans on the sensors or indicators.

Warning and Safety instructions

- ▶ Do not allow solid or liquid sugar, or pieces of plastic or aluminium foil to get onto the cooktop when it is hot, as they can damage the ceramic surface when it cools down. If this should occur, switch off the appliance and scrape off all the sugar, plastic or aluminium residues whilst still hot, using a shielded scraper blade suitable for use on glass. Wear oven gloves when doing this. Allow the ceramic surface to cool down and then clean it with a suitable ceramic cooktop cleaning agent.
- ▶ Pans which boil dry can cause damage to the ceramic glass. Do not leave the cooktop unattended whilst it is being used.
- ▶ Only use pots and pans with smooth bases. Rough bases will scratch the ceramic glass.
- ▶ Lift pans into position on the cooktop. Sliding them into place can cause scuffs and scratches.
- ▶ Because induction heating works extremely quickly, the base of the pan could heat up to the temperature at which oil or fat self-ignites within a very short time. Do not leave the cooktop unattended whilst it is being used.
- ▶ Heat oil or fat for a maximum of one minute. Never use the Booster function to heat oil or fat.
- ▶ For people fitted with a heart pacemaker: please note that the area immediately surrounding the cooktop is electromagnetically charged when it is switched on. It is very unlikely to affect a pacemaker. However, if in any doubt, consult the manufacturer of the pacemaker or your doctor.
- ▶ To prevent damage to items which are susceptible to electromagnetic fields, e.g. credit cards, digital storage devices, pocket calculators, etc., do not leave them in the immediate vicinity of the cooktop.

Warning and Safety instructions

- ▶ Metal utensils stored in a drawer under the cooktop can become hot if the appliance is used intensively for a long time. Do not store any metal items or utensils in a drawer under the cooktop.
- ▶ The cooktop is fitted with a cooling fan. If a drawer is fitted directly underneath the cooktop, ensure that there is sufficient space between the drawer and its contents and the underside of the cooktop in order to ensure sufficient ventilation for the cooktop.
- ▶ If a drawer is fitted directly underneath the cooktop, do not store pointed or small items, paper, serviettes etc. in the drawer. They could get in through the ventilation slots or be sucked into the casing by the fan and damage the fan or impair cooling.
- ▶ If an induction adapter plate is used for cookware, the induction generator may be damaged or even destroyed. Do not use induction adapter plates.

Cleaning and care

- ▶ Do not use a steam cleaning appliance to clean this appliance. The steam could reach the electrical components and cause a short circuit.
- ▶ If the cooktop is built in over a pyrolytic oven, the cooktop should not be used whilst the pyrolytic process is being carried out, as this could trigger the overheating protection mechanism on the cooktop (see “Safety features - Overheating protection”).
- ▶ Miele will guarantee to supply functional spare parts for a minimum of 10 years and up to 15 years following the discontinuation of your cooktop.

Caring for the environment

Disposal of the packing material

The transport and protective packaging has been selected from materials which are environmentally friendly for disposal, and can normally be recycled.

Recycling the packaging reduces the use of raw materials in the manufacturing process and also reduces the amount of waste in landfill sites. Ensure that any plastic wrappings, bags etc. are disposed of safely and kept out of the reach of babies and young children. Danger of suffocation.

Disposing of your old appliance

Electrical and electronic appliances often contain valuable materials. They also contain specific materials, compounds and components, which were essential for their correct function and safety. These could be hazardous to human health and to the environment if disposed of with your domestic waste or if handled incorrectly. Please do not, therefore, dispose of your old appliance with your household waste.



Please dispose of it at your local community waste collection / recycling centre for electrical and electronic appliances. You are also responsible for deleting any personal data that may be stored on the appliance prior to disposal. Please ensure that your old appliance poses no risk to children while being stored prior to disposal.

Cooktop

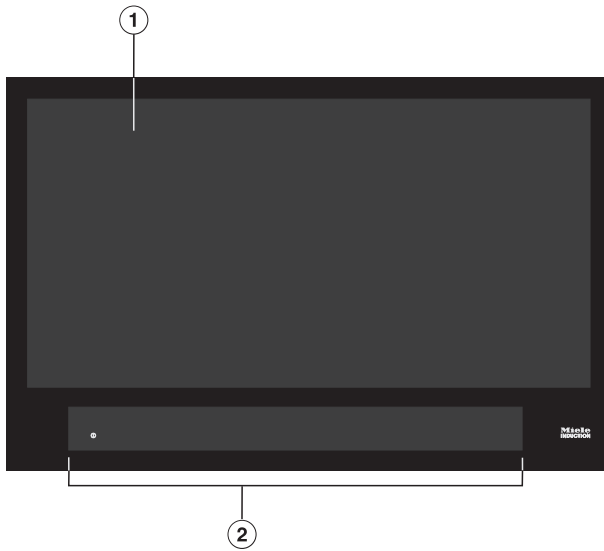

- ① Useable surface of the cooktop for a maximum of 6 pans
- ② Controls and indicators

Overview

Controls and display

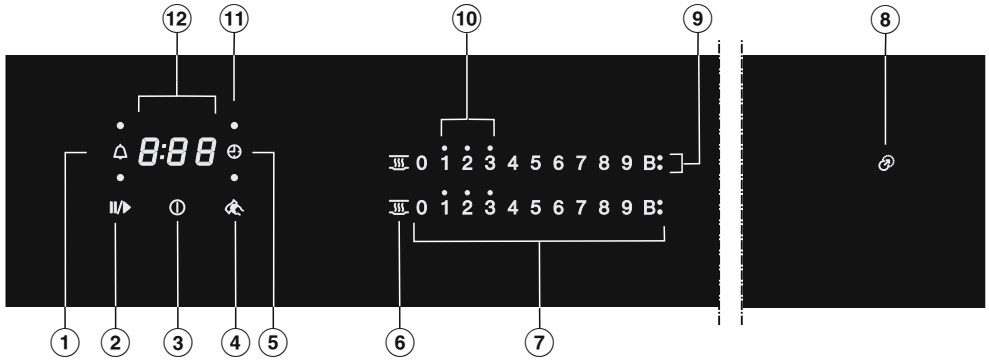

- ① Minute minder sensor
- ② Stop & Go sensor
For stopping/starting a cooking process in progress
- ③ Cooktop On/Off sensor
- ④ Wipe protection sensor
For locking the sensors
- ⑤ Automatic switch-off sensor
Switches off the heating for an item of cookware automatically
- ⑥ Keeping warm sensor
For activating/deactivating the Keeping warm function
- ⑦ Numerical keybank sensors
– For setting the power level
– For setting the times
- ⑧ Positioning aid indicator light
- ⑨ Booster display
Booster function is activated
- ⑩ Residual heat indicator lights
- ⑪ Cookware allocation automatic switch-off indicator light
Automatic switch-off for the heating of an item of cookware is activated
- ⑫ Timer display

0:00 to *9:59* Duration

LOC System lock/Safety lock is activated

dE Demo mode is activated

Before using for the first time

- Please stick the extra data plate for the appliance supplied with this documentation in the space provided in the “Service” section of this booklet. Alternatively, the additional label can be stuck near the appliance if the appliance markings are not visible after installation.
- Remove any protective wrapping and stickers (except the data plate).

Cleaning the cooktop for the first time

- Before using for the first time, clean the cooktop with a damp cloth only and then wipe dry.

Switching on the cooktop for the first time

The metal components have a protective coating which may give off a slight smell when heated up for the first time. The induction coils may also give off a slight smell for the first few hours of operation. This smell will be less noticeable with each subsequent use before dissipating completely.

The smell and any vapours given off do not indicate a faulty connection or appliance and they are not hazardous to health.

Please note that the heating up time on induction cooktops is significantly shorter than on conventional cooktops.

Before using for the first time

Miele@home

Prerequisite: Home Wi-Fi network

Your cooktop is equipped with an integrated Wi-Fi module. The cooktop can be connected to the household Wi-Fi network.

If your Miele rangehood is also connected to the home Wi-Fi network, you can control the rangehood automatically via the Con@ctivity function. Further information can be found in the operating and installation instructions of your rangehood.

Make sure there is sufficient signal strength for your Wi-Fi network where the cooktop is installed.

There are a number of ways of connecting your cooktop to your Wi-Fi network.

The cooktop requires max. 2 W in networked standby.

Availability of the Wi-Fi connection

The Wi-Fi connection shares a frequency range with other appliances (including microwave ovens and remote control toys). This may result in sporadic or even complete connection failures. Therefore, a constant availability of featured functions cannot be guaranteed.

Miele@home availability

The ability to use the Miele App depends on the availability of the Miele@home service in your country.

The Miele@home service is not available in every country.

For information about availability, please visit www.miele.com.

Miele App

You can download the Miele App from the Apple App Store® or the Google Play Store™ free of charge (only functional in selected countries).



After installing the Miele App on a mobile device, you can do the following:

- Call up information on the operating status of your cooktop
- Call up information on the programme sequence of your cooktop
- Set up a Miele@home network with other Wi-Fi enabled Miele appliances

Before using for the first time

Setting up Miele@home

Connecting via the App

The Miele App can be used to connect to your network.

- Install the Miele App on your mobile device.

To log in you will need:

1. Your Wi-Fi network password.
2. The password of your cooktop.

The password for your cooktop consists of the last nine digits of the serial number. This can be found on the appliance's data plate.

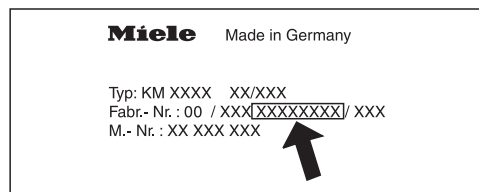

- Switch the cooktop on.
- Place an induction-compatible pan on the cooktop.
- Start the Miele App.
- Touch and hold the 0 and 5 sensors on the numerical keybank at the same time for 6 seconds.

The seconds can be seen counting down in the timer display. When this time has elapsed, the code `C:07` is displayed in the timer display for 10 seconds.

You now have 10 minutes to configure the Wi-Fi.

- Follow the instructions in the App.

Connecting via WPS

You must have a WPS (Wi-Fi protected setup) compatible router.

- Switch the cooktop on.
- Place an induction-compatible pan on the cooktop.
- Touch and hold the 0 and 6 sensors on the numerical keybank at the same time for 6 seconds.

The seconds can be seen counting down in the timer display. When this time has elapsed, a progress light will appear during the connection attempt (for max. 120 seconds).

The WPS login is only active during these 120 seconds.

- Activate the WPS function on your router.

If the connection was successful, the code `C:02` appears in the timer display. If the connection could not be established, the timer display will show the code `C:07`. You have probably not activated WPS on your router quickly enough. Repeat the steps above.

Useful tip: If your Wi-Fi router does not support WPS, please connect via the Miele App.

Before using for the first time

Canceling the process

- Touch any sensor.

Resetting settings

It is not necessary to reset the cooktop when you replace the router.

- Switch the cooktop on.
- Place an induction-compatible pan on the cooktop.
- Touch and hold the 0 and 9 sensors on the numerical keybank at the same time for 6 seconds.

The seconds can be seen counting down in the timer display. When this time has elapsed, the code `C:00` is displayed in the timer display for 10 seconds.

Reset the settings if you are disposing of your cooktop, selling it or putting a used cooktop into operation. This is the only way to ensure that all personal data has been removed and, in the case of the latter situation, the previous owner will no longer be able to access the cooktop.

Con@ctivity

Con@ctivity is the direct communication system between an electric Miele cooktop and a Miele rangehood.

Con@ctivity enables the rangehood to operate automatically depending on the operational state of your Miele cooktop.

Further information can be found in the operating and installation instructions of your rangehood.

The cooktop requires max. 2 W in networked standby.

Availability of the Wi-Fi connection

The Wi-Fi connection shares a frequency range with other appliances (including microwave ovens and remote control toys). This may result in sporadic or even complete connection failures. Therefore, a constant availability of featured functions cannot be guaranteed.

Setting up Con@ctivity

You can set up Con@ctivity via the home Wi-Fi network or via a direct Wi-Fi connection between the cooktop and the rangehood.

Con@ctivity via the home Wi-Fi network (Con@ctivity 3.0)

Prerequisites:

- Home Wi-Fi network
- Wi-Fi-enabled Miele rangehood.

- Connect the rangehood and the cooktop to your home Wi-Fi network (see “Before using for the first time – Miele@home”).

The Con@ctivity function will be activated automatically.

You will find the necessary information for integrating the rangehood in the relevant operating and installation instructions.

Before using for the first time

Con@ctivity via a direct Wi-Fi connection (Con@ctivity 3.0)

Prerequisite: Wi-Fi-enabled Miele rangehood

You will find the necessary information for integrating the rangehood in the relevant operating and installation instructions.

- Switch the cooktop on.
- Place an induction-compatible pan on the cooktop.
- Touch and hold the 0 and 7 sensors on the numerical keybank at the same time for 6 seconds.

The seconds can be seen counting down in the timer display. When this time has elapsed, a progress light will appear in the timer display during the connection attempt. If the connection was successful, the code C:02 appears in the timer display. If the connection could not be established, the timer display will show the code C:01 . Repeat the steps above.

When successfully connected, **2** and **3** will light up constantly on the rangehood.

- Quit connection mode on the rangehood by pressing the run-on control $\text{5} \text{↵}^{15}$.

Con@ctivity has now been activated.

With a direct Wi-Fi connection, it is not possible to connect the cooktop and the rangehood to a home network. If this is desired later, the direct Wi-Fi connection between the cooktop and the rangehood must first be reset (see “Before using for the first time – Con@ctivity” and in the operating and installation instructions for the rangehood see “Disconnecting the Wi-Fi”).

Cancelling the process

- Touch any sensor.

Resetting settings

It is not necessary to reset the cooktop when you replace the router.

- Switch the cooktop on.
- Place an induction-compatible pan on the cooktop.
- Touch and hold the 0 and 9 sensors on the numerical keybank at the same time for 6 seconds.

The seconds can be seen counting down in the timer display. When this time has elapsed, the code `C:00` is displayed in the timer display for 10 seconds.

Reset the settings if you are disposing of your cooktop, selling it or putting a used cooktop into operation. This is the only way to ensure that all personal data has been removed and, in the case of the latter situation, the previous owner will no longer be able to access the cooktop.

How it works

Induction coils are located under the ceramic surface. These coils create a magnetic field that reacts directly with the base of the pan and heats it up. The ceramic surface itself is heated up indirectly by the heat given off by the pan.

The position, size and shape of the pots and pans are recognised automatically by the induction cooktop.

An induction cooktop only works when a pan with a magnetic base is placed on it (see "Cookware").



Risk of burning due to hot items!

When the cooktop is switched on, either deliberately or by mistake, or when there is residual heat present, there is a risk of metal items placed on the cooktop heating up.

Do not use the cooktop as a resting place for anything else.

After use, switch the cooktop off with the  sensor control.

Noises

The following noises can occur in the pan, depending on what it is made of and how it has been constructed.

On the higher power levels, the appliance might buzz. This will decrease or cease altogether when the power level is reduced.

If the pan base is made of layers of different materials (e.g. in a sandwiched base), it might emit a cracking sound.

You might hear a clicking sound from the electronic switches, especially on lower power levels.

You might hear a whirring sound when the cooling fan switches on. It switches on to protect the electronics when the cooktop is being used intensively. The fan may continue to run after the appliance has been switched off.

Suitable pans

- stainless steel pans with a base that can be magnetised
- enamelled steel pans
- cast iron pans

Please be aware that the properties of the pan base can affect the evenness with which the food heats up (e.g. when making pancakes). The base of the pan must be able to distribute the heat evenly. Cookware with a base made of multi-layered material (sandwich or encapsulated base) is suitable.

The pan base material and the positions of the pans on the cooktop affect the power of the induction coils. This can affect the cooking behaviour.

Pan size

Round pans should preferably have a base diameter from 145 mm up to a maximum of 350 mm. Pans with a base diameter between 100 mm and 145 mm will not be detected in every position on the cooktop.

Oval/Square pans must not exceed dimensions of 380 mm x 300 mm.

Unsuitable pans

- stainless steel pans with a base which cannot be magnetised
- aluminium or copper pans
- glass, ceramic or earthenware pots and pans

Testing cookware

To test whether a pot or pan is suitable for use on an induction cooktop, hold a magnet to the base of the pan in several different places. If the magnet sticks, the pan is generally suitable.

Unsuitable pan indicator

When the cooktop is switched on and you place a pan on it but the corresponding number display does not appear:

- the diameter of the base of the pan is too small, or
- the pan is unsuitable

Cookware

Useful tips

- Use only pots and pans with smooth bases. Rough bases can scratch the ceramic glass.
- Always lift the cookware to move it. This will help prevent scratching. If any scratches do appear as a result of cookware being pushed around, this will not affect the function of the cooktop. These scratches are normal signs of use and are not grounds for making a complaint.
- Please note that the maximum diameter quoted by manufacturers often refers to the diameter of the top rim of the pot or pan. The diameter of the base (generally smaller) is more important.

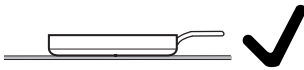

- Where possible, use cookware with vertically straight sides. If a pan has angular sides, induction also acts on the sides of the pan. The sides of the pan may discolour or the coating may peel off.

Tips on saving energy

- Cook in covered pots and pans if possible. This prevents heat escaping unnecessarily.
- Select a smaller pan when cooking small quantities. A smaller pan uses less energy than a larger pan with very little in it.
- Cook with as little water as possible.
- Once food has come to the boil or the pan is hot for frying, reduce the heat to a lower power level.
- Use a pressure cooker to reduce the cooking duration.

Power level range

The cooktop is programmed with 9 power levels at the factory. If you wish to fine-tune a setting, you can extend the power level range to 17 power levels (see "Programming").

	Power level range	
	Default setting (9 power levels)	Extended settings (17 power levels)
Melting butter Melting chocolate Dissolving gelatine	1–2	1–2.
Warming up small quantities of liquid Keeping warm food which sticks easily Cooking rice or porridge Defrosting vegetables frozen in a block	2–4	2–3.
Warming up liquid and semi-solid food Steaming fruit Simmering potatoes (pans with lids)	4–6	3.–5.
Making omelettes or lightly fried eggs Gently frying rissoles Steaming fish and vegetables Cooking dumplings and dried pulses Defrosting and warming up frozen food Thickening sauces, e.g. Hollandaise	5–7	4.–7.
Gently frying meat, fish, sausages and eggs (without overheating the fat)	6–8	6–7.
Cooking potato fritters, pancakes etc.	7–8	7–8.
Deep frying, e.g. chips	9	8.–9
Boiling large quantities of water Bringing to the boil Searing large amounts of meat	9–Booster	8.–Booster

These settings should only be taken as a guide. The power of the induction coils will vary depending on the pan base size and material and the positions of the pans on the cooktop. For this reason, it is possible that the settings will need to be adjusted slightly to suit your pans. As you use the cooktop, you will get to know which settings suit your pans best. When using new pans that you are not familiar with, set the power level below the one specified.

Operating principles

This ceramic cooktop is equipped with electronic sensor controls which react to finger contact. For safety reasons, when switching the appliance on, the On/Off ① sensor needs to be touched for a little longer than the other sensors. Each time you touch a sensor, an acoustic signal sounds.

Only the printed On/Off ① symbol is visible when the cooktop is switched off. More sensor controls light up when the cooktop is switched on.

 Malfunction due to dirty and/or covered sensors.

If the sensors are dirty or covered, this could cause them to fail to react, to activate a function inadvertently or even to switch the appliance off automatically (see "Safety features – Safety switch-off"). Placing hot pans on the sensor controls/indicators can damage the electronic unit underneath.

Keep the sensors and indicators clean.

Do not place anything over the sensors or indicators.

Do not place hot pans over the sensors or indicators.



①

① Sensor controls and indicators

Operation

Positioning cookware

You can use a maximum of 6 pans at the same time on this cooktop.

Useful tips

- You can position the pans anywhere on the useable surface of the cooktop.
- We recommend switching the cooktop on first and then placing the pans on it. If you do this, the pans will be detected more quickly by the cooktop.
- If you are using several pans at once, position them as far apart as possible. This will enable the cooktop to recognise each of them individually.
- Move pans on the cooktop one after the other, not all at the same time.
- When you move a pan on the cooktop, the associated numerical keybank lights up. The set power level “goes along” with it.
- Pans with a base diameter between 100 and 145 mm will not be detected in every position on the cooktop.

Possible faults

You place a pan on the cooktop and the associated numerical keybank does not appear.

The pan cannot be detected in this position because it is very small.

- Reposition the pan. If it is still not detected, use a different pan.

There are several pans on the cooktop. You place another pan on the cooktop and the  symbol lights up.

The pans are too close together.

- Reposition the pans.

Move pans on the cooktop one after the other, not all at the same time.

You reposition a pan and the set power level starts to flash.

The pan cannot be detected.

- Touch the flashing power level.
- If the power level continues to flash, reposition the pan.

You reposition a pan, the set power level goes out and **0** lights up.

- Reset the power level.

 Risk of fire due to overheated food.

Unattended food can overheat and ignite.

Do not leave the cooktop unattended whilst it is being used.

Please note that the heating-up time on induction cooktops is much shorter than on conventional cooktops.

Switching on the cooktop

- Touch the ① sensor.

Further sensor controls will light up.

If no further entry is made, the cooktop will switch itself off after a few seconds for safety reasons.

Setting the power level

- Place the pans in the required position on the cooktop.

The corresponding numerical keybank lights up.

- Touch the appropriate sensor control on the numerical keybank for the power level you want.

If you do not set a power level within approx. 10 seconds, the numerical keybank will go out.

Switching the cooktop off

- Touch the ① sensor.

Residual heat indicator

If an area of the ceramic surface is hot, the residual heat indicator will light up after the cooktop has been switched off. Depending on the temperature, a dot will appear above power levels 1, 2 and 3.

The dots of the residual heat indicator go out one after the other as the ceramic surface cools down. The last dot only goes out when the ceramic surface is safe to touch.

 Risk of burning due to hot ceramic surface.

The ceramic surface will be hot after use.

Do not touch the ceramic surface while the residual heat indicators are on.

Setting the power level – extended power level range

- Touch the numerical keybank between two number sensors.

The sensors in front of and after the interim level will light up brighter than the other sensors.

Example:

If you have set power level 7., the numbers 7 and 8 will be brighter than the other numbers.

Operation

Auto heat-up

When Auto heat-up has been activated, the highest setting automatically switches on and then switches to the continued cooking setting which you have previously selected. The heat-up time depends on which continued cooking setting has been chosen (see chart).

Activating Auto heat-up

- Touch the sensor for the continued cooking setting you want until a tone sounds and the sensor starts to pulsate.

During the heat-up time (see chart), the continued cooking setting selected will pulsate.

With extended power levels (see "Programming") and a selected interim power level, the sensors for the power levels in front of and after the interim power level will pulsate.

Changing the continued cooking setting while heating up deactivates Auto heat-up.

Deactivating Auto heat-up

- Touch the sensor for the continued cooking setting.

Or

- Set a different power level.

Continued cooking setting*	Heat-up time [min:sec]
1	approx. 00:15
1.	approx. 00:15
2	approx. 00:15
2.	approx. 00:15
3	approx. 00:25
3.	approx. 00:25
4	approx. 00:50
4.	approx. 00:50
5	approx. 2:00
5.	approx. 5:50
6	approx. 5:50
6.	approx. 2:50
7	approx. 2:50
7.	approx. 2:50
8	approx. 2:50
8.	approx. 2:50
9	—

* The continued cooking settings with a dot after the number are only available if the power level range has been extended (see "Programming").

Booster

When activated, the power is boosted so that large quantities can be heated up quickly, e.g. when boiling water for cooking pasta. The boost in power is active for a maximum of 15 minutes.

You can use the Booster with a maximum of 3 pans at the same time: 1 on the right-hand side of the cooktop, 1 in the centre and 1 on the left-hand side of the cooktop.

If the Booster function is switched on when

- no power level has been selected, the power level will revert automatically to power level 9 at the end of the Booster time or if the Booster function is switched off before this.
- a power level has been selected, the power level will revert automatically to the power level selected at the end of the Booster time or if the Booster function is switched off before this.

While the Booster is in operation, some of the power is taken away from the other induction coils. If another pan is in use on the same side of the cooktop, it will be affected as follows:

- Auto heat-up is deactivated.
- The power level is reduced.
- The heating is switched off.

Activating TwinBooster

Level 1

- Place the pans in the required position on the cooktop.
- Select a power level if necessary.
- Touch the **B** sensor control.

The ● indicator light for TwinBooster level 1 lights up.

Level 2

- Place the pans in the required position on the cooktop.
- Select a power level if necessary.
- Touch the **B** sensor control twice.

The ◐ indicator light for TwinBooster level 2 lights up.

Deactivating TwinBooster

- Touch the **B** sensor control repeatedly until the indicator lights go out.

or

- Set a different power level.

Operation

Keeping warm

This function is for keeping food warm which has just been cooked and is still hot. It is not for reheating food that has gone cold.

The maximum duration for keeping food warm is 2 hours.

- Only keep food warm in suitable cookware (pots/pans). Cover the pot/pan with a lid.
- Stir firm or viscous food (mashed potatoes, stew) occasionally.
- Nutrients are lost when food is cooked, and continue to diminish when food is kept warm. The longer food is kept warm for, the greater the loss of nutrients. Try to keep food warm for as short a time as possible.

Activating/Deactivating the keeping warm function

- Touch the  sensor control on the corresponding numerical keybank.

Keeping warm temperatures

A keeping warm temperature of 75 °C is set as standard. You can change the keeping warm temperature (see “Programming”).

Use	Temperature °C
Melting chocolate	50–55
Keeping solid food and thick liquids warm	65–75
Keeping clear soups warm	80–90

The cooking result can be negatively affected if food is kept warm at excessively high temperatures. Food can change colour and even spoil.

The cooktop has to be switched on if you wish to use the timer.

The timer can be used for the following 2 functions:

- For setting the minute minder
- For automatically switching off the heating of a pot or pan

You can use the functions simultaneously.

A duration of between 1 minute (0:01) and 9 hours 59 minutes (9:59) can be set.

Durations of up to 59 minutes are shown in minutes (00:59) and durations of more than 60 minutes are shown in hours and minutes. Durations are entered in the order of hours, followed by minutes in tens and then units.

Example:

59 minutes = 00:59 hours,

Enter: 5-9

80 minutes = 1:20 hours,

Enter: 1-2-0

After the first number has been entered, the timer display will light up constantly.

After the second number has been entered, the first number will move to the left. After the third number has been entered, the first and second numbers will move to the left.

Minute minder

The minute minder is set using the left or front left numerical keybank (depending on model).

Setting the minute minder

- Touch the  sensor.

The timer display flashes.

- Set the required time.

Touch the  sensor or wait 10 seconds to start the minute minder.

Changing the time set for the minute minder

- Touch the  sensor.

The timer display flashes.

- Set the required time.

Cancelling the minute minder

- Touch the  sensor.

- Touch  on the numerical keybank.

Timer

Auto switch-off

You can set a time after which the heat for a pan will switch off automatically. This function can be used on all zones at the same time.

If the time programmed is longer than the maximum operational time allowed, the safety switch-off will switch off the heating after the maximum permitted safety time has elapsed (see "Safety features - Safety switch-off").

The switch-off time is set on the numerical display for each pan you want to switch off automatically.

If you reposition a pan and reset the power level, the switch-off time will be deleted. You must then set the switch-off time again.

Setting the switch-off time

- Set a power level for the required pan.
- Touch the  sensor.

The timer display flashes.

- Set the required time.

Touch the  sensor or wait 10 seconds to start the switch-off time.

The cookware allocation automatic switch-off indicator light pulsates.

- To set a switch-off time for another item of cookware, follow the same steps as described above.

If more than one switch-off time is programmed, the shortest time left will be displayed, and the corresponding indicator light will pulsate. The other indicator lights will light up constantly.

- To display the remaining times running in the background, touch the  sensor repeatedly until the indicator light for the desired cookware pulsates.

Changing the switch-off time

- Touch the  sensor repeatedly until the indicator light for the item of cookware you require pulsates.

The timer display flashes.

- Set the required time.

Deleting the switch-off time



- Touch the  sensor repeatedly until the indicator light for the item of cookware you require pulsates.

The timer display flashes.

- Touch the  sensor on the numerical keybank.

Using both timer functions at the same time

If you use both functions simultaneously, the shortest time is always displayed. The  sensor (minute minder) or the indicator light for the item of cookware with the shortest time pulsates.

- Touch the  or  sensor if you want to show the times left counting down in the background.
- If a switch-off time has been programmed for several pans, touch the  sensor repeatedly until the indicator for the required pan pulsates.

Additional functions

Stop & Go

When Stop & Go is activated, all power levels are reduced to 1.

The power levels and the timer settings cannot be altered; the cooktop can only be switched off. The minute minder, automatic switch-off, Booster and Auto heat-up times continue to run.

When the function is deactivated, the appliance switches back to the power level that was set last.

If the function is not deactivated within 1 hour, the cooktop will switch off.

Activating/Deactivating

- Touch the II/▶ sensor.

Use this function if there is a danger of food boiling over.

Recall

If the cooktop is switched off inadvertently during operation, this function can be used to reset all settings. For this to work, the cooktop must be switched on again within 10 seconds of being switched off.

- Switch the cooktop on again.

The previously set power levels flash.

- Press one of the flashing power level indicators immediately.

All settings are restored.

Wipe protection

The cooktop sensors can be locked for 20 seconds in order, for example, to remove soiling. The ① sensor control is not locked.

Activating

- Touch the  sensor.

The time counts down in the timer display.

Deactivating

- Touch the  sensor control until the timer display goes out.

Demonstration/Showroom mode

These functions enable the cooktop to be demonstrated in showrooms without heating up.

Activating/Deactivating the demonstration mode

When this mode is set, the cooktop can be operated as normal.

- Switch the cooktop on.
- Place an induction-compatible pan on the cooktop.
- Touch and hold the 0 and 2 sensors on the numerical keybank at the same time for 6 seconds.

In the timer display, *dE* flashes alternately with *Dn* (demonstration mode activated) or *OFF* (demonstration mode deactivated) for a few seconds.

Activating/Deactivating showroom mode

In showroom mode, cooking processes are simulated in an infinite loop. The sequence of the individual steps is repeated after 1 minute. If you touch a sensor or put pans on the cooktop, it switches to demonstration mode.

- Switch the cooktop on.
- Place an induction-compatible pan on the cooktop.
- Touch and hold the 0 and 8 sensors on the numerical keybank at the same time for 6 seconds.

In the timer display, *dE* flashes alternately with *Dn* (showroom mode activated) or *OFF* (showroom mode deactivated) for a few seconds.

Additional functions

Displaying cooktop data

The model designation and software version can be displayed.

Model number/Serial number

- Switch the cooktop on.
- Place an induction-compatible pan on the cooktop.
- Touch and hold the 0 and 4 sensor controls on the numerical keybank at the same time.

Numbers will appear in the timer display one after another, separated by a dash.

Example: *12 34* (Model number KM 1234) – *1 23 45 67 89* (Serial number)

Software version

- Switch the cooktop on.
- Place an induction-compatible pan on the cooktop.
- Touch and hold the 0 and 3 sensor controls on the numerical keybank at the same time.

Numbers appear in the timer display:

Example: *2:00* = Software version 2.00

System lock/Safety lock

Your cooktop is equipped with a system lock and a safety lock to prevent it being switched on or any settings being altered by mistake.

The **system lock** is activated when the cooktop is switched off. If the system lock is activated, the cooktop cannot be switched on and the timer cannot be used. A set minute minder time continues to count down. The cooktop is programmed so that the system lock must be activated manually. It can be programmed so that the system lock activates automatically 5 minutes after the cooktop has been switched off (see "Programming").

The **safety lock** is activated while the cooktop is switched on. When the safety lock is activated, the cooktop can be operated only under certain conditions:

- The cooktop can only be switched off.
- Selected power levels **cannot** be changed.
- A set minute minder time can be modified.

If an unavailable sensor is touched whilst the system lock or safety lock is activated, *LDC* will appear in the timer display for a few seconds and a tone will sound.

Activating the system lock

- Touch the  sensor for 6 seconds.



The seconds can be seen counting down in the timer display. When this time has elapsed, *LDC* will appear in the timer display. The system lock is switched on.

Deactivating the system lock

- Touch the  sensor for 6 seconds.



LDC will appear briefly in the timer display and then the seconds will count down. The system lock is deactivated once the time has elapsed.

Activating the safety lock

- Touch and hold the  and  sensors at the same time for 6 seconds.

The seconds can be seen counting down in the timer display. When this time has elapsed *LDC* will appear in the timer display. The safety lock is activated.

Deactivating the safety lock

- Touch and hold the  and  sensors at the same time for 6 seconds.

LDC will appear briefly in the timer display and then the seconds will count down. The safety lock is deactivated once the time has elapsed.

Safety features

Safety switch-off

Sensor controls are covered

Your cooktop will switch off automatically if one or several of the sensors remain covered for longer than 10 seconds, for example, by finger contact, food boiling over or by an object such as an oven glove or tea towel. \mathcal{L} flashes briefly above the $\textcircled{1}$ sensor control and a tone will sound. \mathcal{L} will go out once you have removed the object and/or cleaned the cooktop and the cooktop will be ready to use again.

Excessive operating time

The safety switch-off mechanism is triggered automatically if an area is heated for an unusually long period of time. This time depends on the power level selected. If it has been exceeded, the heat switches off and the residual heat indicator will appear. A power level can be selected in the usual way.

The cooktop is programmed to safety setting 0 at the factory. If required, you can set a higher safety setting with a shorter maximum operating time (see chart).

Power level*	Maximum operating time [h:min]		
	Safety setting		
	0**	1	2
1	10:00	8:00	5:00
1.	10:00	7:00	4:00
2/2.	5:00	4:00	3:00
3/3.	5:00	3:30	2:00
4/4.	4:00	2:00	1:30
5/5.	4:00	1:30	1:00
6/6.	4:00	1:00	00:30
7/7.	4:00	00:42	00:24
8	4:00	00:30	00:20
8.	4:00	00:30	00:18
9	1:00	00:24	00:10

* The power levels with a dot after the number are only available if the power level range has been extended (see "Power level range").

** Factory default setting

Overheating protection

All the induction coils and cooling elements for the electronics are fitted with an overheating protection mechanism. Before the induction coils and/or cooling elements get too hot, the overheating protection mechanism activates in one of the following ways:

Induction coils

- Any Booster function in operation will be switched off.
- The set power level is reduced.
- The heat switches off automatically. *Err* will flash alternately with 044 in the timer display.

You can use the area again as usual when the fault message has gone out.

Cooling elements

- Any Booster function in operation will be switched off.
- The set power level is reduced.
- The heat switches off automatically.

The affected cooking areas can only be used again as usual once the cooling element has cooled down to a safe level.

The overheating protection may be triggered under the following circumstances:

- The pot or pan being used is empty.
- Fat or oil being heated on a high power level.
- Insufficient ventilation to the underside of the cooktop.
- A hot area is switched on again after an interruption to the power supply.

If, despite removing the cause, the overheating protection mechanism triggers again, contact Miele.

Programming

You can adapt the programming of the cooktop to your personal needs. Several settings can be altered in succession.

After accessing programming mode, the ⊕ symbol appears and *PC* will appear in the timer display. After a few seconds *P:01* (Programme 01) will flash alternately with *Ⓛ:01* (Code) in the timer display.

Changing the programming

Calling up programming

The **II/▶** sensor is located approx. 1 cm (index finger width) to the left of the **Ⓛ** sensor.

- **With the cooktop switched off,** press and hold the **Ⓛ** and **II/▶** sensor controls together until the ⊕ symbol lights up and *PC* appears in the timer display.

Setting a programme

For a two-digit programme number you need to first set the tens position.

- Whilst the programme is visible in the display (e.g. *P:01*), touch the ⊕ sensor repeatedly until the number for the programme you want appears in the display or touch the appropriate number on the numerical keybank.

Setting the code

- While the code is visible in the display (e.g. *Ⓛ:01*), touch the ⊕ sensor repeatedly until the number for the code you want appears in the display or touch the appropriate number on the numerical keybank.

How to save the settings

- While the programme is visible in the display (e.g. *P:01*), touch the **Ⓛ** sensor control until the indicators go out.

How to avoid saving the settings

- While the code is visible in the display (e.g. *Ⓛ:01*), touch the **Ⓛ** sensor until the indicators go out.

Programming

Programme ¹		Code ²	Settings
P:01	Demonstration/Showroom mode	C:00	Demonstration mode off
		C:01	Demo mode on ³
		C:02	Showroom mode on ³
P:02	Power management ⁴	C:00	Off
		C:01	3680 W
		C:02	3000 W
		C:03	2000 W
		C:04	1000 W
P:03	Factory default setting	C:00	Do not restore the factory default settings
		C:01	Restore factory default settings
P:04	Number of power levels for cookware	C:00	9 power levels + Booster
		C:01	17 power levels + Booster ⁵
P:06	Confirmation tone when a sensor control is touched	C:00	Off ⁶
		C:01	Quiet
		C:02	Medium
		C:03	Loud
P:07	Timer signal tone	C:00	Off
		C:01	Quiet
		C:02	Medium
		C:03	Loud
P:08	System lock	C:00	System lock can only be activated manually
		C:01	Activating the system lock automatically
P:09	Maximum operating time	C:00	Safety setting 0
		C:01	Safety setting 1
		C:02	Safety setting 2

Programming

Programme ¹		Code ²	Settings
P:10	Signing Wi-Fi on	C:00	Not active/deactivated
		C:01	Active but not configured
		C:02	Active and configured (cannot be selected; displays whether connection was successful)
		C:03	Connection possible via WPS push button
		C:04	Wi-Fi is reset to default (C:00)
		C:05	Direct Wi-Fi connection of cooktop and rangehood without Miele App (Con@ctivity 3.0)
P:12	Sensor controls reaction speed	C:00	Slow
		C:01	Normal
		C:02	Fast
P:14	Confirmation of power level when position of pan is changed	C:00	Confirmation necessary
		C:01	Confirmation not necessary

Programme ¹		Code ²	Settings
P:25	Keeping warm temperature	C:00	50 °C
		C:01	55 °C
		C:02	60 °C
		C:03	65 °C
		C:04	70 °C
		C:05	75 °C
		C:06	80 °C
		C:07	85 °C
		C:08	90 °C

1) Programmes not shown here have no allocation.

2) The factory default setting is shown in bold.

3) After the cooktop has been switched on, *dE* appears in the timer display for a few seconds.

4) The total output of the cooktop may be reduced in order to meet the local network provider's requirements.

5) In the text and charts, the extended power levels are shown with a dot after the number.

6) The confirmation tone of the On/Off sensor cannot be switched off.

Cleaning and care

Safety notes on cleaning and care

 Risk of burning due to hot surfaces.

All parts of the cooktop may be hot after use.

Switch the cooktop off.

Allow the cooktop to cool down before cleaning it.

All surfaces could be discoloured or damaged if unsuitable cleaning agents are used or if residues from suitable cleaning agents are heated on the cooktop.

Allow the surfaces to cool down before cleaning the cooktop.

Remove any residual cleaning agent immediately.

Never use abrasive sponges or cleaning agents.

- ▶ Do not use a steam cleaner to clean the cooktop.
- ▶ Do not use pointed objects for cleaning.

- The entire cooktop should be cleaned after each use.

Removing light soiling

- Clean the entire cooktop with a damp, soft cloth and a solution of water and a little washing-up liquid. Please follow the cleaning agent manufacturer's instructions.

Removing stubborn soiling

- Remove any coarse soiling with a damp cloth and more stubborn soiling with a glass scraper.
- Clean the glass ceramic surface with the Miele ceramic and stainless steel cooktop cleaner (see "Optional accessories – Cleaning and care products") or with a proprietary ceramic glass cleaner. Please follow the cleaning agent manufacturer's instructions.

Finishing the cleaning process

- Remove all cleaning agent residues with a damp cleaning cloth.
- Dry the cooktop thoroughly after cleaning with water.

Unsuitable cleaning agents

To avoid damaging the surfaces of the appliance, do not use:

- cleaning agents containing soda, alkalines, ammonia, acids or chlorides
- stain and rust removers
- abrasive cleaning agents, e.g. powder cleaners and cream cleaners
- solvent-based cleaning agents
- dishwasher cleaners
- grill and oven cleaners
- hard, abrasive brushes or sponges (e.g. pot scourers), or sponges which have been previously used and still contain abrasive cleaning agents
- sponges
- dirt eraser sponges

Problem solving guide

Many malfunctions and minor faults that can occur in daily operation can be corrected without contacting Miele. This will save you time and money because you will not need a service call.

You can find information on how to remedy faults yourself at www.miele.com/service.

Please note, however, that a call-out charge will be applied to unnecessary service visits where the problem could have been rectified as described in these operating instructions.

Messages in the display

Problem	Possible cause and remedy
Err will flash alternately with 30 in the timer display and a tone will sound.	The cooktop is incorrectly connected. <ul style="list-style-type: none">■ Disconnect the cooktop from the electricity supply.■ Contact Miele. The cooktop must be connected to the mains according to the wiring diagram.
After the cooktop has been switched on, L0C appears in the timer display for a few seconds.	The system lock or safety lock is activated. <ul style="list-style-type: none">■ Deactivate the system lock or safety lock (see "Safety features - System lock / Safety lock").
After the cooktop has been switched on, dE appears in the timer display for a few seconds. The cooktop does not heat up.	The cooktop is in demonstration mode. <ul style="list-style-type: none">■ Touch the 0 sensor on any of the numerical keybanks.■ Then touch the 0 and 2 sensors at the same time until dE flashes alternately with 0FF in the timer display.
The cooktop has switched off automatically. When the cooktop is switched back on, L appears above the On/Off  sensor.	One or more of the sensors are covered, e.g. by finger contact, food boiling over or an object. <ul style="list-style-type: none">■ Clean off any dirt and/or remove the object (see "Safety features - Safety switch-off").
Err will flash alternately with 044 in the timer display.	The overheating protection mechanism has been activated. <ul style="list-style-type: none">■ See "Safety features - Overheating protection".

Problem solving guide

Problem	Possible cause and remedy
Err will flash alternately with 047, 048 or 049 in the timer display.	The fan is blocked or defective. <ul style="list-style-type: none">■ Make sure the fan has not been blocked by an object.■ Remove the obstruction.■ If this fault code continues to appear in the display, contact Miele.
In the timer display E-number, e.g. E-0, will flash alternately with 120, 121, 122, 123, 124, 125, 126, or 127.	The fan is blocked or defective. <ul style="list-style-type: none">■ Make sure the fan has not been blocked by an object.■ Remove the obstruction.■ If this fault code continues to appear in the display, contact Miele.
A message not listed in this table is appearing in the timer display.	There is an electronic unit fault. <ul style="list-style-type: none">■ Interrupt the power supply to the cooktop for approx. 1 minute.■ If the problem persists after power is restored, please contact Miele.

Problem solving guide

Unexpected behaviour

Problem	Possible cause and remedy
When you place a pot or a pan on the cooktop the corresponding numerical keybank does not appear.	The pan cannot be detected in this position because it is very small. ■ Reposition the pan. If it is still not detected, use a different pan.
	The pan is unsuitable. ■ Use suitable pans (see “Cookware”).
The  symbol lights up.	The pans are too close together. ■ Reposition the pans. Move the pans one after the other, not all at the same time.
You reposition a pan and the set power level starts to flash.	The pan cannot be detected. ■ Touch the flashing power level. ■ If the power level continues to flash, reposition the pan.
You reposition a pan, the set power level goes out and 0 lights up.	The pan cannot be detected. ■ Reset the power level.
An area switches itself off automatically.	It has been operated for too long. ■ Set a power level again (see “Safety features - Safety switch-off”).
An area is not working in the usual way on the power level selected.	The overheating protection mechanism has been activated. ■ See “Safety features - Overheating protection”.
An area or the whole cooktop switches off automatically.	The overheating protection mechanism has been activated. ■ See “Safety features - Overheating protection”.
The Booster has automatically switched off early.	The overheating protection mechanism has been activated. ■ See “Safety features - Overheating protection”.

Unsatisfactory results

Problem	Possible cause and remedy
The food in the pan hardly heats up or does not heat up at all when the Auto heat-up function is switched on.	There is too much food in the pan. ■ Start cooking at the highest power level and then turn down to a lower one manually later on.
	The pan is not conducting heat properly. ■ Use a different pan which is better able to conduct heat.
In comparable cooking and frying processes there are slight differences in cooking durations and browning.	This is not a fault. The pan base material and the positions of the pans on the cooktop affect the power of the induction coils. This in turn affects the cooking behaviour.

Problem solving guide

General problems or technical faults

Problem	Possible cause and remedy
The cooktop cannot be switched on.	<p>There is no power to the cooktop.</p> <ul style="list-style-type: none">■ Check if the circuit breaker has tripped. Contact an electrician or Miele (for the minimum fuse rating, see data plate). <p>There may be a technical fault.</p> <ul style="list-style-type: none">■ Disconnect the cooktop from the mains electricity supply for approx. 1 minute. To do this:<ul style="list-style-type: none">– switch off at the wall socket and withdraw the plug, or– switch off the mains circuit breaker or residual current device.■ If, after switching the circuit breaker or residual current device back on, the appliance will still not switch on, contact a qualified electrician or Miele.
A smell and vapours are given off when the new appliance is being used.	<p>The metal components have a protective coating. When the appliance is used for the first time, this causes a smell and possibly also vapour. The material from which the induction coils are made also gives off a smell in the first few hours of operation. This smell will be less noticeable with each subsequent use before dissipating completely. The smell and any vapours given off do not indicate a faulty connection or appliance and they are not hazardous to health.</p>
A noise can be heard after the appliance is switched off.	<p>The fan will continue running until the cooktop has cooled down. It will then switch itself off automatically.</p>

Miele offers a range of useful accessories, as well as cleaning and conditioning products for your appliance.

These products can be ordered from the Miele online shop.

They can also be ordered directly from Miele (see end of this booklet for contact details).

Cookware

Miele offers a large selection of cookware for purchase. These have all been optimised in terms of functionality and dimensions for Miele appliances. Detailed information can be found on the Miele website.

Cleaning and care products

Miele ceramic and stainless steel cooktop cleaner 250 ml

Removes heavy soiling, limescale deposits, and aluminium residues.

Original Miele all purpose microfibre cloth

Removes finger marks and light soiling.

Service

You can find information on how to remedy faults yourself and about Miele spare parts at www.miele.com/service.

Contact in case of fault

In the event of any faults which you cannot remedy yourself, please contact Miele.

You can book a Miele customer service call-out online at www.miele.com.au/service or www.miele.co.nz/service.

Contact information for Miele can be found at the end of this booklet.

Please quote the model and serial number of your appliance when contacting Miele. This information can be found on the data plate.

Data plate

Adhere the extra data plate supplied with the appliance in the space below. Make sure that the model number matches the one specified on the back cover of these operating and installation instructions.

Warranty

The manufacturer's warranty for this appliance is 2 years.

For further information, please refer to your warranty booklet.

Safety instructions for installation

 Risk of damage from incorrect installation.
Incorrect installation can cause damage to the cooktop.
The cooktop must only be installed by a qualified person.

 Risk of electric shock.
Incorrect connection to the power supply may result in an electric shock.
The cooktop must be connected to the power supply by a qualified electrician.

 Damage from falling objects.
Take care not to damage the cooktop when fitting wall units or a rangehood above it.
Fit the wall units and the rangehood before the cooktop.

- ▶ The veneer or laminate coatings of worktops (or adjacent kitchen units) must be treated with 100 °C heat-resistant adhesive which will not dissolve or distort. Any splashbacks must be of heat-resistant material.
- ▶ The cooktop must not be installed over a fridge, fridge-freezer, freezer, dishwasher, washing machine, washer-dryer or tumble dryer.
- ▶ This cooktop must not be installed above ovens unless these have a built-in cooling fan.
- ▶ After installation, ensure that nothing can come into contact with the connection cable and that it is without hindrance.
- ▶ The connection cable may not come into contact with any moving kitchen component (e.g. a drawer) or be subject to mechanical obstruction which could damage it.
- ▶ Carefully observe the safety clearances listed on the following pages.

Installation

Safety distances

Safety distance above the cooktop

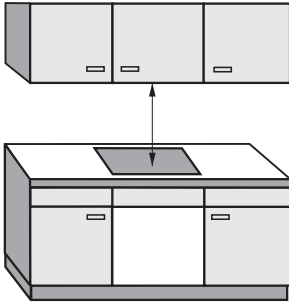

The safety distance specified by the manufacturer of the rangehood must be maintained between the cooktop and the rangehood above it.

If the manufacturer's instructions are not available for the rangehood, a minimum safety distance of 500 mm must be maintained.

For any flammable objects, e.g. utensil rails, wall units etc., a minimum safety distance of 500 mm must be maintained between these objects and the highest part of the cooktop below.

When two or more appliances which have different safety distances are installed together below a rangehood, observe the greatest specified safety distance.

Safety distances to the sides and back of the appliance

The minimum distance shown below must be maintained between the back edge of the cooktop and a tall unit or wall.

Ideally the cooktop should be installed with plenty of space on either side. There may be a wall at the rear or a tall unit or wall on one side (right or left), taking into account the distances below. On the other side, however, no tall unit or wall should stand closer than 200 mm to the edge of the cooktop. Before installing the cooktop, check that the below clearance requirements are met.

Minimum horizontal distance from the **back edge** of the cooktop to a combustible surface:
50 mm.

Minimum horizontal distance from the **right edge** of the cooktop to a combustible surface:
50 mm.

Minimum horizontal distance from the **left edge** of the cooktop to a combustible surface:
50 mm.

Minimum safety distance underneath the cooktop

To ensure sufficient ventilation to the cooktop, a minimum distance must be left between the underside of the cooktop and any oven, interim shelf or drawer.

The minimum safety distance between the underside¹ of the cooktop and

- the top edge of an oven: ≥ 8 mm
- the top edge of an interim shelf: ≥ 8 mm
- the top edge of a drawer: ≥ 8 mm
- the base of a drawer: ≥ 75 mm

¹ The underside is the outside of the cooktop casing. Other items that are attached lower down, such as connection boxes and spacer plates, do not count as the lowest point and are not relevant when calculating the minimum safety distance.

Interim shelf

It is not necessary to fit an interim shelf underneath the cooktop but one may be fitted if you wish.

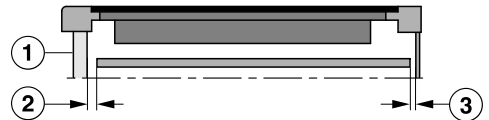

Side view

- ① Front
- ② Front air gap
- ③ Rear air gap

Installation

A gap ② of 20 mm is recommended at the front between the cabinet and intermediate shelf for better **ventilation** of the cooktop.

Leave a gap ③ of 30 mm at the back between the cabinet and the intermediate shelf to **accommodate the mains connection cable**.

Installation notes – surface-mounted

Seal between the cooktop and the worktop

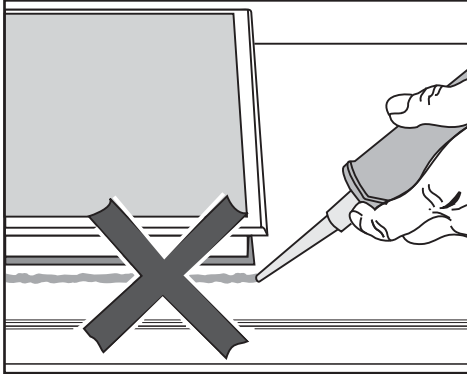

 **Damage caused by incorrect installation.**

Using sealant under the cooktop could result in damage to the cooktop and the worktop if the cooktop ever needs to be removed for servicing.

Do not use sealant between the cooktop and the worktop.

The sealing strip under the edge of the cooktop provides a sufficient seal for the worktop.

Sealing strip

Dismantling the cooktop for service purposes may damage the sealing strip underneath the edge of the cooktop.

Always replace the sealing strip before reinstalling the cooktop.

Tiled worktop

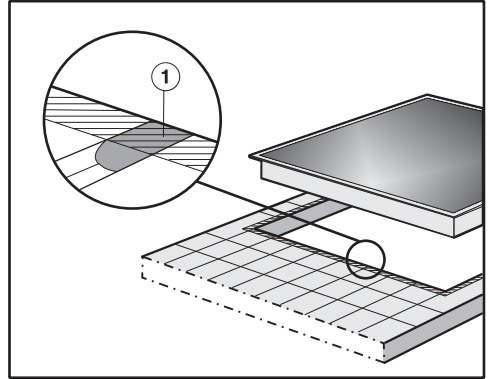

Grout lines ① and the hatched area underneath the cooktop frame must be smooth and even. If they are not, the cooktop will not sit flush with the worktop and the sealing strip underneath the cooktop will not provide a good seal between the cooktop and the worktop.

Do not install DiamondFinish cooktops in front of a window

It is not recommended to install DiamondFinish models in front of a window.

Direct daylight causes the surface of the cooktop to reflect more strongly and makes the indicators more difficult to recognise.

KM 7897-2 FL Diamond

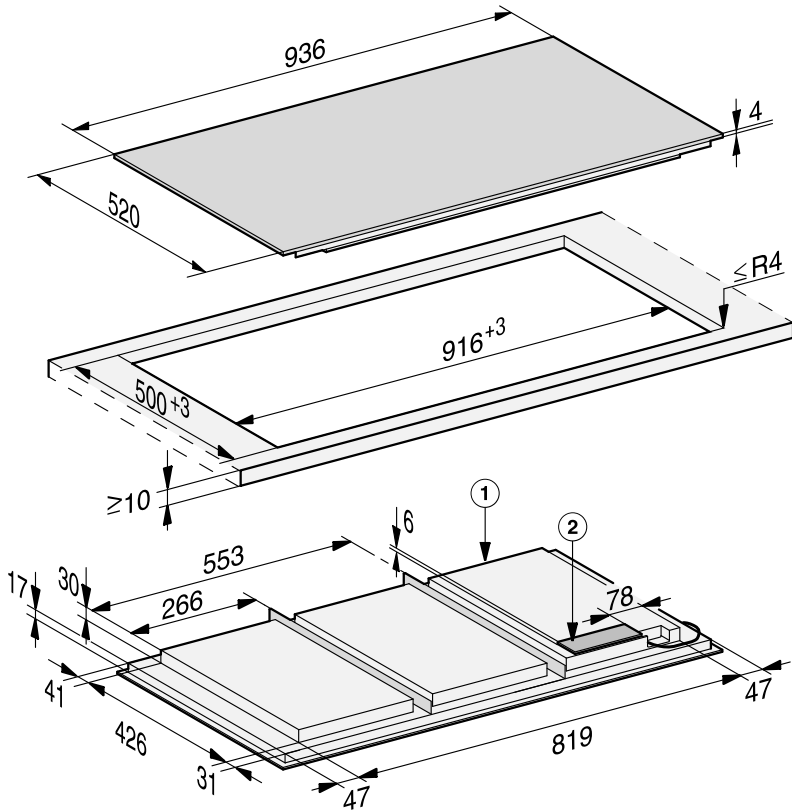

① Front

② Mains connection box

The mains connection cable (L = 1,440 mm) is supplied loose

Installation

Surface-mounted installation

- Create the worktop cut-out.
Remember to maintain the minimum safety distances (see “Installation – Safety distances”).
- Seal the cut surfaces of **wooden worktops** with a suitable sealant to avoid swelling caused by moisture. The sealant must be heat-resistant.

Make sure the sealant does not come into contact with the top surface of the worktop.

- Attach the sealing strip provided underneath the edge of the cooktop. Do not apply the sealing strip under tension.



Risk of damage from incorrect connection.

The electronics of the cooktop may be damaged if a short-circuit occurs. The mains connection cable must be connected to the cooktop by a qualified electrician.

- Connect the mains connection cable by following the instructions in the wiring diagram on the cooktop (see “Installation – Electrical connection”).
- Feed the mains connection cable down through the worktop cut-out.
- Place the cooktop centrally in the cut-out. When doing this make sure that the seal of the appliance sits flush with the worktop on all sides. This is important to ensure an effective seal with the worktop.

If the seal does not meet the worktop correctly on the corners, the corner radius ($\leq R4$) can be carefully scribed to suit.

- Connect the cooktop to the electricity supply (see “Installation – Electrical connection”).
- Check that the cooktop works.

Installation notes – flush-fit

A flush-fit cooktop is suitable only for installation in natural stone (granite, marble), solid wood and tiled worktops. When using a worktop made from any other material, please check first with the worktop manufacturer that it is suitable for installing a flush-fit cooktop.

The internal width of the base unit underneath the appliance must be at least as wide as the inner worktop cut-out (see “Installation – Installation dimensions – Flush-fit”), so that the cooktop is easily accessible from underneath after installation and the bottom half of the casing can be removed for maintenance. If the underside of the cooktop is not freely accessible after installation, any sealant used to plug the gaps around the appliance must be removed to enable the cooktop to be lifted out of the cut-out should this be necessary.

Natural stone worktops

The cooktop is placed directly in the cut-out.

Solid wood worktops, tiled worktops, glass worktops

The cooktop is placed on a wooden frame inside the cut-out. The frame must be provided on site and is not supplied with the appliance.

Sealing strip

Dismantling the cooktop for service purposes may damage the sealing strip underneath the edge of the cooktop.

Always replace the sealing strip before reinstalling the cooktop.

Do not install DiamondFinish cooktops in front of a window

It is not recommended to install DiamondFinish models in front of a window.

Direct daylight causes the surface of the cooktop to reflect more strongly and makes the indicators more difficult to recognise.

Installation

Installation dimensions – Flush-fit

All dimensions in this instruction booklet are given in mm.

KM 7678-2 FL, KM 7878-2 FL Diamond

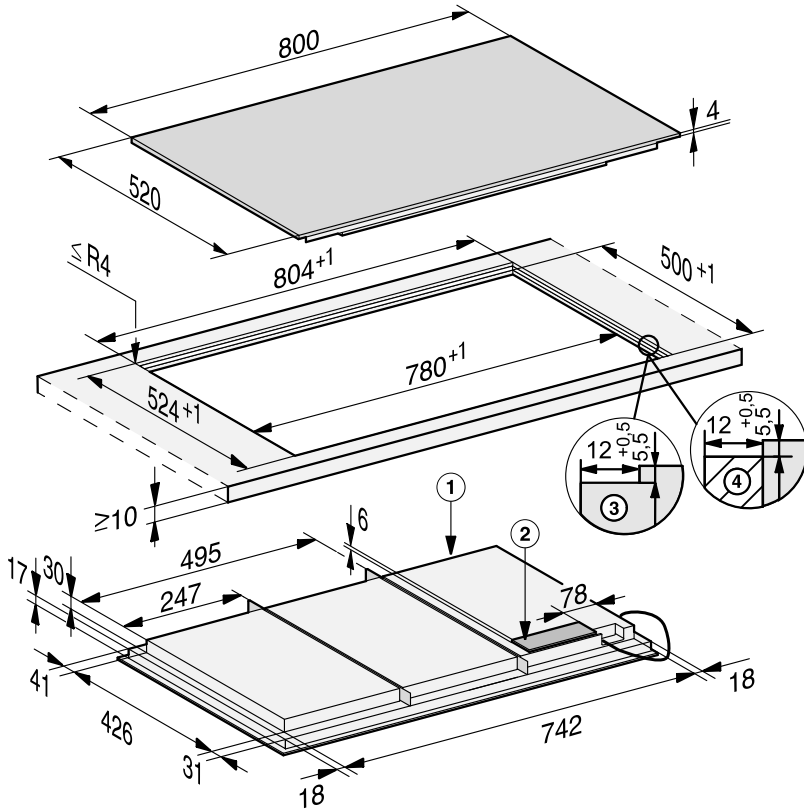

- ① Front
- ② Mains connection box
The mains connection cable (L = 1,440 mm) is supplied loose
- ③ Stepped cut-out, natural stone worktop
- ④ Wooden strip 12 mm (not supplied)

KM 7897-2 FL Diamond

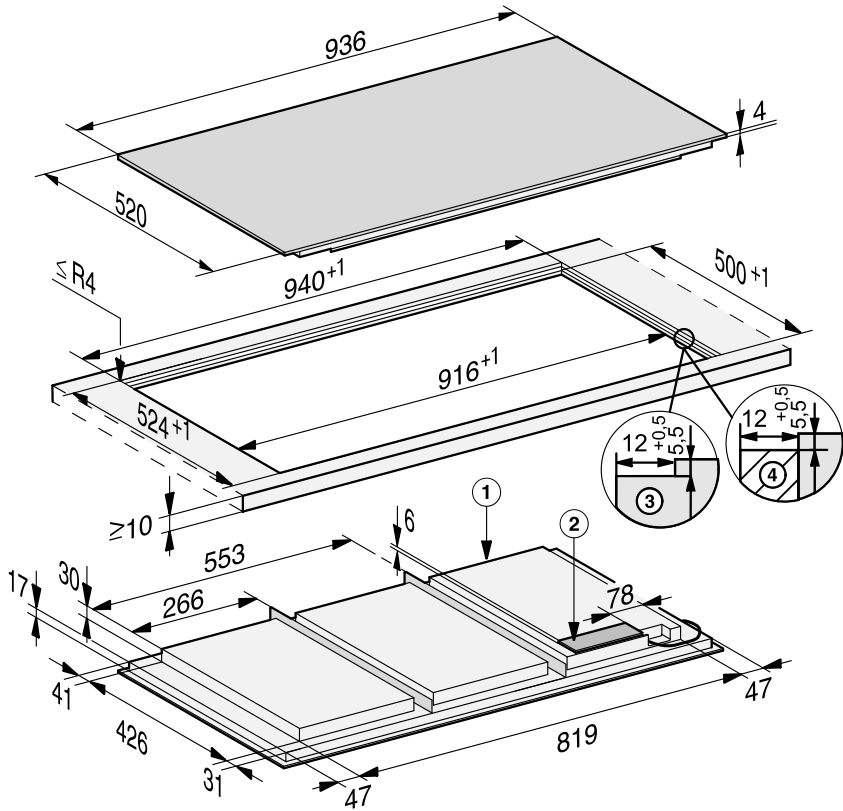

- ① Front
- ② Mains connection box
The mains connection cable (L = 1,440 mm) is supplied loose
- ③ Stepped cut-out, natural stone worktop
- ④ Wooden strip 12 mm (not supplied)

Installation

Flush-fit installation

- Create the worktop cut-out.
Remember to maintain the minimum safety distances (see "Safety distances").
- Solid wood, tiled and glass worktops:
Fix a wooden frame 5.5 mm below the top edge of the worktop.

 Risk of damage from incorrect connection.

The electronics of the cooktop may be damaged if a short-circuit occurs. The mains connection cable must be connected to the cooktop by a qualified electrician.

- Connect the mains connection cable by following the instructions in the wiring diagram on the cooktop (see "Electrical connection – Wiring diagram").
- Attach the sealing strip provided underneath the edge of the cooktop. Do not apply the sealing strip under tension.
- Feed the mains connection cable down through the worktop cut-out.
- Centre the cooktop in the cut-out.

The gap between the ceramic surface and the worktop must be at least 2 mm wide. This is required so that the cooktop can be sealed.

- Connect the cooktop to the mains electricity supply (see "Electrical connection").
- Check that the cooktop works.

- Seal the gap between the cooktop and worktop with a silicone sealant that is heat-resistant to at least 160 °C.

 Damage caused by unsuitable sealant.

Unsuitable sealant can damage natural stone.

For natural stone worktops and natural stone tiles, only use silicone sealant that is specially formulated for natural stone. Please follow the manufacturer's instructions.

Electrical connection

 Risk of damage from incorrect connection.

Incorrect installation, maintenance and repairs can be dangerous to users.

Miele cannot be held liable for damage or injury caused by incorrect or unauthorised installation, maintenance or repair work, or by an inadequate or faulty on-site earthing system (e.g. electric shock).

All electrical work must be carried out by a suitably qualified and competent electrician, in strict accordance with current national and local safety regulations, and any additional regulations of the local electricity provider.

After installation, ensure that all electrical components are shielded and cannot be accessed by users.

Total power output

See data plate.

Connection data

The connection data is quoted on the data plate. Please ensure this information matches the household mains supply.

Please see the wiring diagrams for connection.

Residual current device

For extra safety, it is advisable to protect the appliance with a suitable residual current device (RCD) with a trip range of 30 mA.

Disconnecting devices

Connection must be made via a suitable isolator switch which provides disconnection on all poles and which complies with national and local safety regulations. When switched off there must be an all-pole contact gap of at least 3 mm in the isolator switch. The isolator switch must be easily accessible after the appliance has been built in.

Installation

Mains connection cable

The cooktop must be connected to the electrical supply with a special connection cable, type H 07 RN-F (rubber insulated) with a suitable cross-section in accordance with the wiring diagram.

Please see the wiring diagrams for connection.

See the data plate on the cooktop for the correct voltage and rated load.

Replacing the mains connection cable



Danger of electric shock!

Incorrect connection to the electricity supply may result in an electric shock.

The mains connection cable must only be replaced in accordance with current local and national safety regulations.

When replacing the mains connection cable, it must be replaced with cable type H 07 RN-F (rubber insulated) by a Miele authorised service technician or a suitably qualified and competent electrician in order to avoid a hazard. These cables are available from Miele.

Wiring diagram

Some connection methods are not permitted in all installation locations. Ensure compliance with national regulations and any additional regulations issued by the local electricity provider.

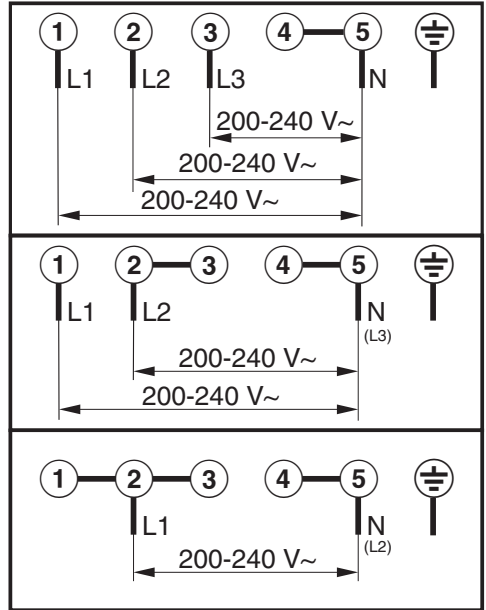

Miele Australia Pty. Ltd.

ACN 005 635 398
ABN 96 005 635 398

Miele Head Office Melbourne:

Level 4, 141 Camberwell Road
Hawthorn East, VIC 3123

Miele Experience Centre Doncaster:

1136/7 Doncaster Shopping Centre
619 Doncaster Rd, Doncaster, VIC 3108

Miele Experience Centre South Melbourne:

206-210 Coventry Street
South Melbourne, VIC 3205

Miele Experience Centre and Office Sydney:

3 Skyline Place
Frenchs Forest, NSW 2086

Miele Experience Centre and Office Brisbane:

Tenancy 4C, 63 Skyring Terrace
Newstead, QLD 4006

Miele Experience Centre Gold Coast:

131 Ferry Road
Southport, QLD 4215

Miele Experience Centre and Office Adelaide:

83-85 Sir Donald Bradman Drive
Hilton, SA 5033

Miele Experience Centre and Office Perth:

205-207 Stirling Highway
Claremont, WA 6010

1300 464 353 (1300 4 MIELE)

www.miele.com.au

Miele New Zealand Limited

IRD 98 463 631

**Miele Experience Centre
and Head Office Auckland:**

8 College Hill
Freemans Bay, Auckland 1011

**Miele Experience Centre
Wellington:**

183 Featherston Street
Wellington 6011

0800 464 353 (0800 4 MIELE)

www.miele.co.nz

**Miele Global Headquarters
Germany**

Miele & Cie. KG

Carl-Miele-Straße 29
33332 Gütersloh
Federal Republic of Germany

KM 7678-2 FL, KM 7878-2 FL Diamond,
KM 7897-2 FL Diamond