

Operating instructions Washing machine





To avoid the risk of accidents or damage to the appliance, it is **essential** to read these instructions before it is installed and used for the first time.

Contents

Warning and Safety instructions	5
Operating the washing machine	10
Control panel.....	10
How the control panel works.....	11
Caring for the environment	12
Before using for the first time	13
Washing environmentally and economically	15
1. Preparing the laundry	16
2. Loading the washing machine	17
3. Selecting a programme	18
4. Adding detergent	19
Detergent dispenser drawer	19
CapDosing.....	20
5. Starting the programme	22
Adding or removing laundry during a programme sequence (AddLoad)	22
6. At the end of the programme	23
Spinning	24
Delay start	25
Programme chart	26
Extras	29
Short.....	29
Water +	29
Pre-wash.....	29
Pre-ironing.....	29
The following Extras can be selected in addition to the programme.....	29
Programme sequence	30
Changing the programme sequence	33
Changing the programme (safety lock)	33
Cancelling a programme.....	33
Garment care label symbols	34
Detergent	35
The correct detergent	35
Detergent dispensing aids	35
Fabric softeners and liquid starch.....	35
Detergent recommendations (according to Ecodesign no. 2019/2023)	36

Cleaning and care	37
External casing and fascia panel	37
Cleaning the detergent dispenser drawer	37
Hygiene info(Cleaning the drum)	39
Cleaning the water inlet filter.....	39
Problem solving guide	40
The programme does not start.....	40
The programme is cancelled and a fault indicator light lights up in the control panel.....	40
During the programme, a symbol appears in the time display	41
At the end of the programme, an indicator light lights up in the control panel	41
General problems with the washing machine.....	42
An unsatisfactory wash result	44
The door will not open	44
Opening the door in the event of a blocked drain outlet and/or power cut.....	45
Service	47
Contact in case of fault.....	47
Optional accessories	47
Warranty	47
Installation	48
Front view	48
Rear view	49
Installation surface.....	50
Transporting the washing machine to its installation site	50
Removing the transit bars	51
Fitting the transit bars	52
Levelling the machine	53
Screwing out and adjusting the feet	53
Installing under a continuous worktop	54
Plinth.....	54
Washer and dryer stack	54
The Miele water protection system.....	55
Connection to the water supply.....	55
Connecting the water inlet hose	56
Drainage.....	56
Using the elbow	57
Direct connection to a sink drain outlet	57
Electrical connection	58
Technical data	59
Consumption data	60

Contents

Programmable functions	61
Choosing and selecting programmable functions	61
Editing and saving the programmable function	62
Exiting the programming level	62
<i>P11</i> Buzzer duration.....	62
<i>P12</i> Buzzer	62
<i>P13</i> Keypad tone	62
<i>P14</i> PIN Code	63
<i>P22</i> Control panel standby status.....	63
<i>P24</i> Memory.....	63
<i>P26</i> Longer pre-wash Cottons.....	64
<i>P28</i> Gentle action.....	64
<i>P29</i> Reduce temperature	64
<i>P30</i> Water plus.....	64
<i>P31</i> Water plus level	64
<i>P32</i> Maximum rinse level.....	65
<i>P33</i> Suds cooling.....	65
<i>P34</i> Anti-crease.....	65
<i>P49</i> Low water pressure	65
<i>P62</i> Backlight brightness dimmed	66
<i>P90</i> Operating hours	66
<i>P00</i> factory default setting.....	66
Detergents and care products	67
Detergent.....	67
Specialist detergents 	67
Fabric care 	68
Additive 	68
Machine care products.....	68

Warning and Safety instructions

This washing machine complies with all current local and national safety requirements. However, inappropriate use can lead to personal injury and damage to property.

Read the operating instructions carefully before using the washing machine. They contain important information on safety, installation, use and maintenance of the appliance. This prevents both personal injury and damage to the washing machine.

In accordance with standard IEC 60335-1, Miele expressly and strongly advises that you read and follow the instructions in “Installation”, as well as in the “Warning and Safety instructions”.

Miele cannot be held liable for injury or damage caused by non-compliance with these instructions.

Keep these operating instructions in a safe place and pass them on to any future owner.

Correct application

- ▶ This washing machine is designed for domestic use and for use in similar environments by guests in hotel or motel rooms, bed & breakfasts and other typical living quarters. This does not include common/shared facilities or commercial facilities within hotels, motels or bed & breakfasts.
- ▶ The washing machine is not suitable for outdoor use.
- ▶ It must only be used to wash garments which have been declared suitable for washing by the manufacturer indicated on the garment care label. Any other use is not permitted. Miele cannot be held liable for damage resulting from incorrect or improper use or operation.
- ▶ This washing machine is not intended for use by persons (including children) with reduced physical, sensory or mental capabilities, or lack of experience and knowledge, unless they have been given supervision or instruction concerning its use by a person responsible for their safety.

Safety with children

- ▶ Young children must not be allowed to use this appliance.
- ▶ Cleaning work may only be carried out by older children under the supervision of an adult.

Warning and Safety instructions

- ▶ Older children may only use the appliance when its operation has been clearly explained to them and they are able to use it safely, recognising the dangers of misuse.
- ▶ Please supervise children in the vicinity of the washing machine and do not let them play with it.

Technical safety

- ▶ Please observe the instructions in “Installation” and “Technical data”.
- ▶ Before setting up the washing machine, check it for any externally visible damage. Do not install or use a damaged machine.
- ▶ Before connecting the washing machine, ensure that the connection data on the data plate (fuse rating, voltage and frequency) matches the mains electricity supply. If in any doubt, consult a qualified electrician.
- ▶ The electrical safety of this washing machine can only be guaranteed when continuity is complete between it and an effective earthing system which complies with current local and national safety regulations. It is most important that this basic safety requirement is present and regularly tested and, where there is any doubt, the household wiring system should be inspected by a qualified electrician. Miele cannot be held liable for the consequences of an inadequate earthing system (e.g. electric shock).
- ▶ Do not connect the washing machine to the mains electricity supply by a multi-socket adapter, extension lead or similar. These do not guarantee the required safety of the machine (fire hazard due to the risk of overheating).
- ▶ Faulty components must only be replaced by genuine Miele spare parts. Miele can only guarantee the safety of the appliance when Miele replacement parts are used.
- ▶ The electrical socket must be easily accessible after installation so that the machine can be disconnected from the electricity supply if necessary.
- ▶ If the connection cable is faulty, it must only be replaced by a Miele approved service technician to protect the user from danger.
- ▶ The manufacturer's warranty will be invalidated if the appliance is not repaired by a Miele approved service technician.

Warning and Safety instructions

- ▶ Unauthorised repairs could result in unforeseen dangers for the user, for which Miele cannot accept liability. Repairs should only be undertaken by a Miele authorised service technician, otherwise any subsequent damage will not be covered by the warranty.
- ▶ This washing machine must not be installed and operated in mobile installations (e.g. on a ship).
- ▶ Do not make any alterations to the machine, unless authorised to do so by Miele.
- ▶ In the event of a fault or for cleaning purposes, the washing machine is only completely isolated from the electricity supply when:
 - it is switched off at the wall socket and the plug is withdrawn, or
 - it is switched off at the mains circuit breaker.
- ▶ The machine must only be connected to the on-site water supply using a new hose kit. Old hose kits must not be re-used. Check the condition of the hoses regularly so that you can replace them in good time and avoid the risk of any water damage.
- ▶ The water flow pressure must be at least 100 kPa and must not exceed 1000 kPa.
- ▶ Temporary or permanent operation with a self-sufficient or non-mains synchronous energy supply system (e.g. isolated networks, back-up systems) is possible. A requirement for the operation is that the energy supply system complies with all current local and national requirements that apply to stand-alone, solar and/or battery systems. The protective measures provided in the installation and in this Miele product must also be assured in their function and operation in isolated operation or in non-mains synchronous operation, or replaced with equivalent measures in the installation.

Correct use

- ▶ Do not install the washing machine in a room where there is a risk of frost. Frozen hoses may burst or split. The reliability of the electronic control unit may be impaired at temperatures below freezing point.
- ▶ Before using the machine for the first time, check that the transit bars at the rear of the machine have been removed (see “Installation - Removing the transit bars”). During spinning, a transit bar which is still in place may result in damage to both the machine and adjacent furniture or appliances.

Warning and Safety instructions

- ▶ Turn off the tap if the machine is to be left for any length of time (e.g. holiday), especially if there is no floor drain (gully) in the immediate vicinity.
- ▶ Flooding danger.
If hooking the drain hose into a laundry washtub, check that the water can drain off quickly enough to prevent the laundry tub from overflowing. Make sure the drain hose is secure, so that the force of the water flowing out of the hose does not dislodge it.
- ▶ Take care to ensure that foreign objects (e.g. nails, pins, coins, paper clips) do not find their way into the machine with the laundry. These may damage components of the machine (e.g. suds container, drum), which in turn can result in damage to the laundry.
- ▶ Take care when opening the drum door after using the steam function. There is a danger of burning due to escaping steam and the high temperature of the surface of the drum as well as the porthole glass. Stand back away from the machine and wait until the steam has dissipated.
- ▶ The maximum load for this washing machine is 8.0 kg (dry weight). See the “Programme chart” for the maximum recommended loads for individual programmes.
- ▶ Do not use solvent based cleaning agents, e.g. those containing benzene, in this machine, as this may result in damage to component parts and create toxic fumes. Such agents also pose a fire and explosion hazard.
- ▶ Textiles which have been pre-treated in solvent based cleaning agents must be thoroughly rinsed in clean water before being washed in the machine.
- ▶ If the correct amount of detergent is dispensed, the machine should not need to be descaled. If, however, you do wish to descale it, only use a proprietary natural citric acid based descaling agent. Miele recommends using Miele descaler for washing machines which is available to order online at shop.miele.com (depending on country) or from Miele. Strictly observe the instructions on the packaging.
- ▶ Do not use solvent based cleaning agents, e.g. those containing benzene, to clean the external surfaces of the machine. They can cause damage to plastic surfaces.
- ▶ Only use dyes specified by the manufacturer as being suitable for use in a domestic washing machine. Always observe the manufacturer's instructions carefully.

Warning and Safety instructions

- ▶ Colour run and dye removers contain sulphur compounds which can cause damage such as corrosion. Do not use these products in this machine.
- ▶ If detergent comes into contact with the eyes, rinse them thoroughly with lukewarm water immediately. If swallowed, seek medical assistance immediately and retain the packaging or label for reference. Those with skin problems or sensitive skin should avoid their skin coming into contact with detergent.

Accessories and spare parts

- ▶ Only use original Miele accessories and spare parts. If other parts are used, warranty, performance and product liability claims will be invalidated.
- ▶ A Miele tumble dryer can be stacked on top of a Miele washing machine using the appropriate stacking kit (available as an optional accessory). Please make sure you order the correct one for the Miele washing machine and Miele tumble dryer.
- ▶ Miele will guarantee to supply functional spare parts for a minimum of 10 years and up to 15 years following the discontinuation of your washing machine.

Miele cannot be held liable for damage caused by non-compliance with these Warning and Safety instructions.

Operating the washing machine

Control panel

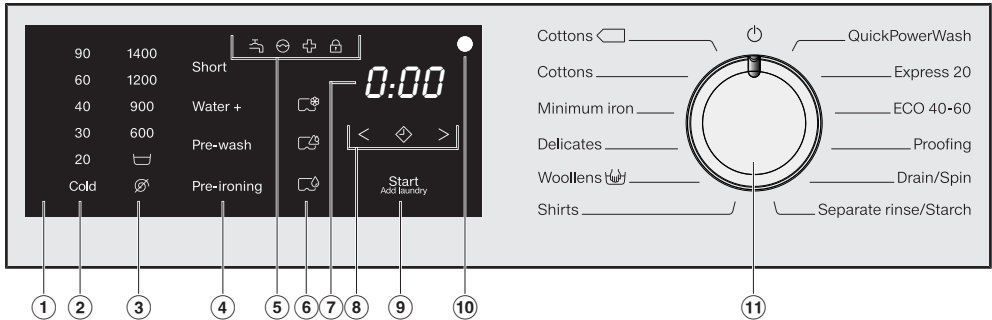

① Control panel

The control panel consists of a time display and various sensor controls. The individual sensors are explained in the following.





② Sensor controls – temperature for selecting the temperature.

③ Sensor controls – spin speeds for selecting the spin speed.



④ Sensor controls for Extras

You can supplement wash programmes with Extras. If a wash programme has been selected, the sensor controls for the possible Extras light up dimly.

⑤ Indicator lights

-  lights up if there are faults with the water inlet and drainage
-  lights up if excess detergent was used
-  lights up as a reminder about hygiene information
-  The *Add laundry* function cannot be selected

⑥ Sensor controls – CapDosing

-  CapDosing of fabric care products (e.g. fabric softener)
-  CapDosing of additives (e.g. booster)
-  CapDosing of detergent (for the main wash only)

⑦ Time display

After the programme has started, the programme duration will appear in the display in hours and minutes. When Delay start is being used, the programme duration will appear after the Delay start time has elapsed.

⑧ < ◊ > sensor controls

The Delay start time selected will appear in the time display. After the programme has started, the Delay start time will begin to count down.

Once the Delay start time has elapsed, the programme begins and the estimated programme duration appears in the time display.

◊ After touching the ◊ sensor, a later start time for the programme (Delay start) can be selected. Once selected, ◊ lights up brightly.

> The duration of the Delay start period is increased by touching the > sensor.

< The duration of the Delay start period is reduced by touching the < sensor.

⑨ Start/Add laundry sensor

Ⓐ The programme can be started as soon as the sensor is flashing on and off. Touching the *Start/Add laundry* sensor starts the selected programme. The sensor lights up constantly.

Ⓑ Once the programme has been started, the *Start/Add laundry* sensor allows you to add laundry.

⑩ Optical interface

For service technicians.

⑪ Programme selector

For selecting programmes and for switching off the appliance. The washing machine is switched on by selecting a programme, and switched off by turning the programme selector to the ⏻ position.

How the control panel works

The ②, ③, ④, ⑥, ⑧ and ⑨ sensors react to fingertip contact. Selection is possible as long as the respective sensor is illuminated.

If a sensor is brightly lit, this means: currently selected

If a sensor is dimly lit, this means: selection possible

Caring for the environment

Disposal of the packing material

The transport and protective packaging has been selected from materials which are environmentally friendly for disposal, and can normally be recycled.

Recycling the packaging reduces the use of raw materials in the manufacturing process and also reduces the amount of waste in landfill sites.

Ensure that any plastic wrappings, bags etc. are disposed of safely and kept out of the reach of babies and young children. Danger of suffocation.

Only for Australia: Note for installer: Expanded polystyrene (EPS) packaging included. Please retain and dispose of EPS packaging responsibly. For further information, please contact Miele.

Disposing of your old appliance

Electrical and electronic appliances often contain valuable materials. They also contain specific materials, compounds and components, which were essential for their correct function and safety. These could be hazardous to human health and to the environment if disposed of with your domestic waste or if handled incorrectly. Please do not, therefore, dispose of your old appliance with your household waste.



Please dispose of it at your local community waste collection / recycling centre for electrical and electronic appliances. You are also responsible for deleting any personal data that may be stored on the appliance prior to disposal. Please ensure that your old appliance poses no risk to children while being stored prior to disposal.

Before using for the first time

 Damage resulting from incorrect installation and connection. Installing and connecting the washing machine incorrectly will cause serious damage to property. See “Installation”.

Removing the protective foil and advertising stickers

■ Remove:

- the protective foil from the door (if present).
- any advertising stickers from the front and the lid.

Please do not remove any labels (e.g. the data plate) which are visible when you open the door.

Remove the drain hose elbow from the drum

An elbow piece for the drain hose is stored in the drum.

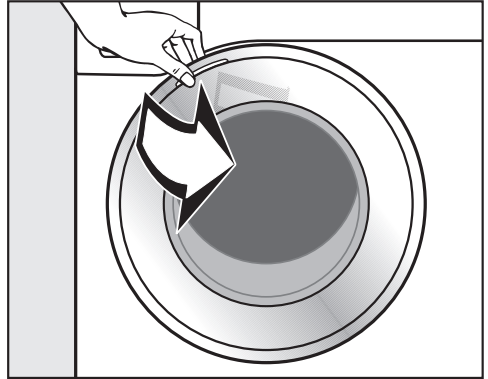

- Pull open the door.
- Remove the elbow piece.

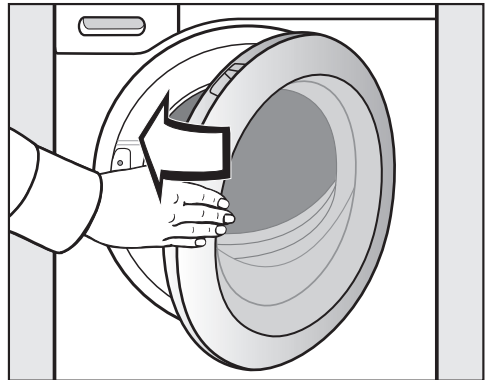

- Shut the door with a gentle swing.

This washing machine has undergone a complete functional test at the factory and there will be some residual water in the drum from this process.

Before using for the first time

Running the first programme

For optimum water and energy consumption and excellent wash results, it is important to calibrate the washing machine.

To do this, the *Cottons* programme **must** be run without laundry and without detergent.

- Turn on the tap.

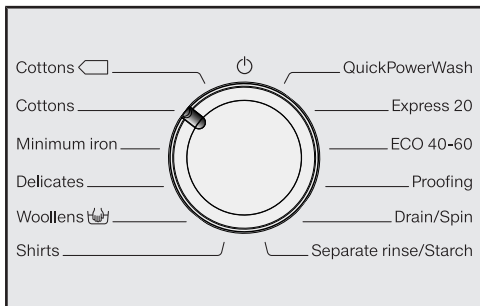

- Turn the programme selector to the *Cottons* position.

The washing machine is now switched on and in the control panel the temperature 60°C lights up.

- Touch the *Start/Add laundry* sensor.

The programme will start.

After 10 minutes, the indicators dim, except for the *Start/Add laundry* sensor.

Opening the door at the end of the programme

The door remains locked during the Anti-crease phase. The control panel lights up for 10 minutes after the programme ends. The control panel then goes out and the *Start/Add laundry* sensor flashes.

- Turn the programme selector to the  position.

-U- appears in the time display and the  indicator light goes out.

The door will unlock.

Useful tip: After the Anti-crease phase, the washing machine will have switched off and the door unlocked automatically. The control panel is completely dark.

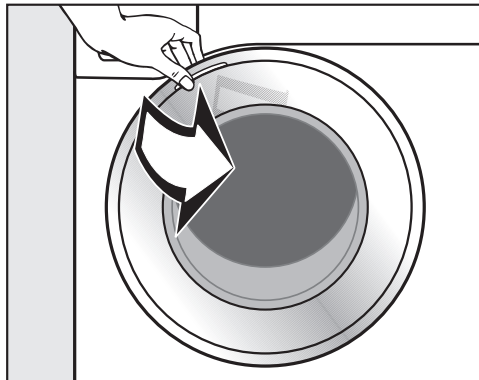

- Take hold of the door and pull it open.

Useful tip: For safety reasons, close the door when the washing machine is not in use. Otherwise there is a danger of objects being placed inadvertently in the drum. If these remain unnoticed and were washed in the next load, they could damage the laundry. An open door is also a danger to pets and children.

The appliance is now ready for use.

Washing environmentally and economically

Energy and water consumption

- To get the most out of your machine, load the maximum dry load size for the wash programme you are using. This will keep the energy and water consumption to a minimum in relation to the size of the load.
- Programmes that are more efficient with regard to energy and water consumption generally have a longer running time. By extending the programme running time, the wash temperature that is actually reached can be reduced while still providing the same wash results.

For example, the Cottons $\langle 40^{\circ}\text{C} \rangle$ programme has a longer running time than the Cottons 40°C or 60°C programme, but the Cottons $\langle 40^{\circ}\text{C} \rangle$ programme is more efficient in terms of energy and water consumption.

- Use the Express 20 programme for small, lightly soiled loads.
- Modern detergents make it possible to wash at lower temperatures (e.g. 20°C). Using lower temperature settings will save energy.

Hygiene in the washing machine

Washing at low temperatures and/or using liquid detergents can cause bacteria and odours to build up in the washing machine. Miele therefore recommends cleaning the washing machine once every month.

When the \oplus indicator light appears in the control field, the washing machine must be cleaned.

Information about subsequent tumble drying

The spin speed selected affects the residual moisture in the laundry and the sound emissions of the washing machine.

The higher the spin speed, the lower the residual moisture in the laundry. However, the sound emissions of the washing machine will increase.

Select the highest possible spin speed for the wash programme to save energy in the subsequent tumble dryer cycle.

Detergent consumption

- Do not exceed the amounts of detergent recommended by the manufacturer on the packaging.
- Adjust the dosage to the degree of soiling of the laundry.
- Reduce the amount of detergent with smaller loads (approx. $\frac{1}{3}$ less than the amount recommended can be used when washing a half load).

1. Preparing the laundry



- Empty all pockets.

⚠ Damage due to foreign objects. Nails, coins, paper clips, and so on can cause damage to garments and components in the machine. Check the laundry before washing and remove any foreign objects.

Sorting the laundry

- Sort the laundry by colour and by care label. Most garments have a textile care label in the collar or side seam.

Useful tip: Dark textiles often contain excess dye and should be washed separately several times before being included in a mixed load. Always wash white and coloured items separately.

Pre-treating stains

- Badly soiled areas and stains should be cleaned as soon as possible, preferably whilst still fresh. Spillages should be carefully dabbed off using a soft, colourfast cloth. Do not rub.

Useful tip: Please refer to the Miele website or Miele@mobile App for more information on stain removal.

⚠ Damage due to solvent-based cleaning agents. Cleaning agents containing benzene, stain remover, etc., can damage plastic parts. When pre-treating garments, make sure that any plastic parts (e.g. buttons) do not come into contact with cleaning agent.

⚠ Risk of explosion due to solvent-based cleaning agents. If solvent-based cleaning agents are used, an explosive mixture can form. Never use solvent-based cleaning agents in the washing machine.

General tips

- Curtains: remove lead weights first or place in a laundry bag.
- Remove or sew in any loose underwiring in bras or shirt collar stiffeners.
- Close any zips, attach velcro fasteners, fasten hooks and eyes etc. before washing.
- Fasten duvet covers and pillow cases to prevent small items from being rolled up inside them.

Do not wash items which are specified by the manufacturer as **not washable** on the care label (☒ symbol).

2. Loading the washing machine

Opening the door

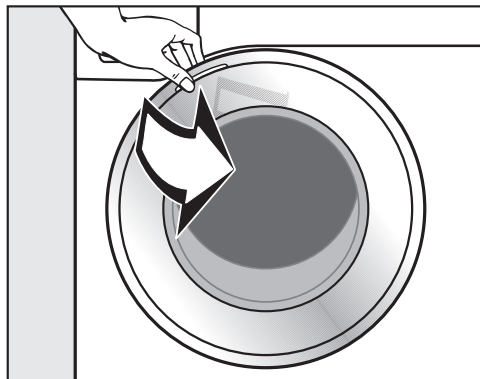

- Take hold of the door and pull it open.

Check the drum for pets or foreign objects before loading it with laundry.

The most efficient use of energy and water is achieved when a full load is washed. However, do not overload as this reduces cleaning efficiency and causes creasing.

- Unfold the laundry and load loosely in the drum.

Mixing both large and small items gives better wash results and helps distribute the load evenly during spinning.

Useful tip: Please note the maximum load size for different wash programmes.

Closing the door

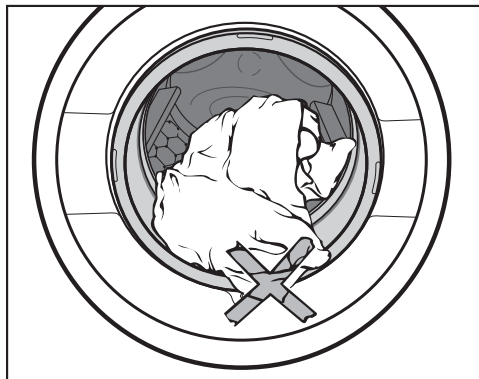

- Make sure that no items are caught between the door and the seal.

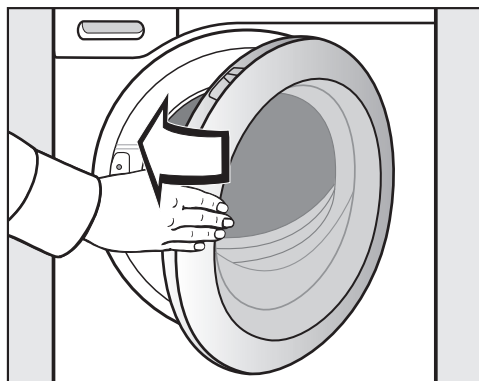

- Shut the door with a gentle swing.

3. Selecting a programme

Programme selection

The washing machine is switched on by turning the programme selector to a wash programme.

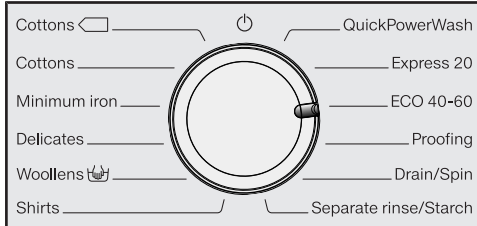

- Turn the programme selector to the required programme.

The likely wash time is shown in the time display and the pre-set temperature and spin speed light up in the control panel.

Selecting the temperature and spin speed

The wash programme's pre-set temperature and spin speed light up brightly. The choice of temperatures and spin speeds selectable for the wash programme light up dimly.

The temperatures reached in the washing machine may differ from the selected temperatures. The combination of energy input and washing time achieves an optimum washing result.

90	1400
60	1200
40	900
30	600
20	
Cold	

- Touch the sensor for the temperature you want. It then lights up brightly.
- Touch the sensor for the spin speed you want. It then lights up brightly.

Selecting Extras

The selection of Extras available for the wash programme lights up dimly.

Short
Water +
Pre-wash
Pre-ironing

- Touch the sensor for the Extra you want. It then lights up brightly.

Useful tip: You can select multiple Extras for a wash programme.

Please refer to “Extras” for more information.

4. Adding detergent

Detergent dispenser drawer

Any detergent suitable for automatic front loading washing machines can be used with this appliance. Please observe the instructions for use and dosage on the detergent packaging.

Filling with detergent

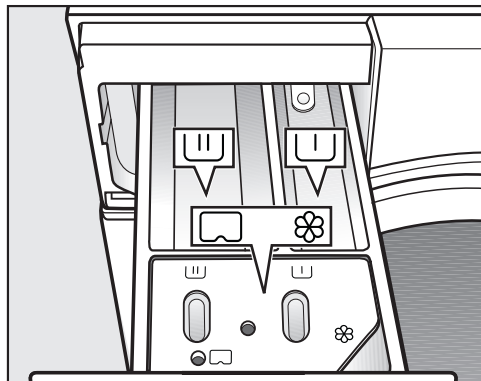

- Pull out the detergent drawer and add detergents to the compartments.

|| Detergent for the pre-wash (divide the total recommended amount as follows: add $\frac{1}{3}$ to compartment "I" and $\frac{2}{3}$ to compartment "II")

|| Detergent for the main wash

⊗ Fabric softener, liquid starch, or capsules

Adding fabric softener

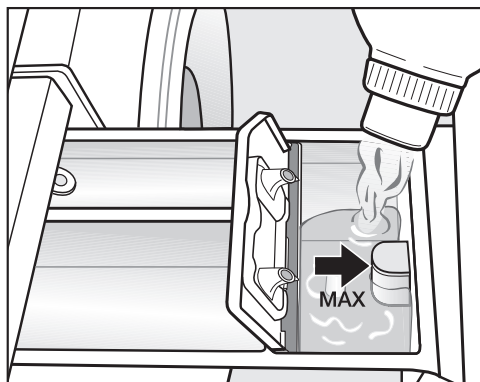

- Add fabric softener or liquid starch to the ⊗ compartment. **Do not exceed the maximum level mark.**

It will be automatically dispensed in the final rinse. At the end of the programme a small amount of water remains in the fabric softener ⊗ compartment.



Starch can make the siphon tube sticky.

If starching frequently, thoroughly clean the dispenser compartment, especially the siphon tube, regularly.

4. Adding detergent

CapDosing

Three different types of capsule are available:

-  = Fabric care (e.g. fabric softener)
-  = Additives (e.g. booster)
-  = Detergent (for the main wash only)

Each capsule contains the correct amount for one wash cycle.

You can order the capsules online at shop.miele.com (depending on country) or from Miele (see the end of this booklet for contact details).

 Capsules pose a health risk. The ingredients of capsules can be hazardous to health if they are swallowed or come into contact with skin. Keep capsules out of the reach of children.

Activating CapDosing

- Touch the sensor for the capsule you want to use.

Sensor



for



for



for



Capsule

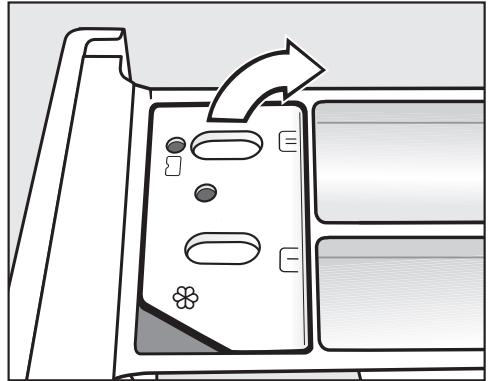

Inserting a capsule

- Open the detergent dispenser drawer.



- Open the lid of the /  compartment.

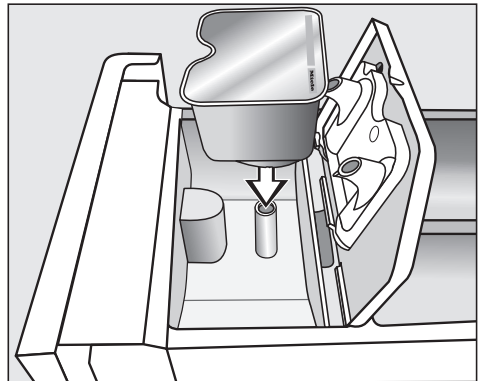

- Press the capsule in firmly.

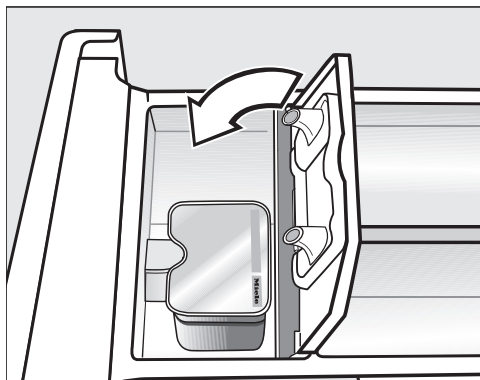

4. Adding detergent



- Close the lid and press it firmly shut.
- Close the detergent dispenser drawer.

The capsule is opened by the act of inserting it in the detergent dispenser drawer. The contents can run out of the capsule if you then remove it from the drawer before it is used. In this case, dispose of the capsule and do not re-use it.

The wash programme will dispense the contents of the capsule at the correct time.

Water intake to the  compartment is solely via the capsule. No additional fabric softener may be added to the  compartment when using a capsule.

- Remove the empty capsule at the end of the programme.

For technical reasons a small amount of water will remain in the capsule.

Deactivating/Changing CapDosing

- In order to switch off CapDosing, touch the brightly lit sensor.
- In order to change CapDosing, touch one of the other capsule sensors.

Tips on dosing

Adjust the detergent dosage to the level of soiling of the laundry and the size of the load. Reduce the amount of detergent with smaller loads (e.g. reduce the amount of detergent by $\frac{1}{3}$ when washing a half load).

Too little detergent results in:

- laundry not getting properly clean and with time it may become grey and hard to the touch.
- a build-up of mould in the washing machine.
- grease not being completely removed from the laundry.
- limescale deposits on the heater elements.

Too much detergent results in:

- poor wash, rinse, and spin results.
- a higher water consumption as an extra rinse cycle is automatically activated.
- a greater burden on the environment.

5. Starting the programme

Starting a programme



- Touch the flashing *Start/Add laundry* sensor.

The door will lock and the programme will start.

If a Delay start time has been selected, this counts down in the time display. At the end of the Delay start time or immediately after the programme has started (if no Delay start time has been selected), the programme duration will appear in the time display.

Energy savings

After 10 minutes, the indicators will dim. The *Start/Add laundry* sensor flashes slowly.



You can reactivate the indicators:

- Touch the *Start/Add laundry* sensor (this does not have any effect on a running programme).

Adding or removing laundry during a programme sequence (AddLoad)

Laundry can be added or removed at any time, provided that the  symbol is not illuminated in the control panel.

- Touch the *Start/Add laundry* sensor.

Rotating bars  ...  ...  are shown in the time display.

If the word *Add* appears in the time display, the door can be opened.

- Open the door and add or remove laundry.
- Close the door.
- Touch the *Start/Add laundry* sensor.

The wash programme will continue.

Laundry cannot usually be added or removed if:

- The suds temperature is above 55°C
- The water inside the drum is above a certain level

6. At the end of the programme

Opening the door and removing the laundry

The door remains locked during the Anti-crease phase. The control panel lights up for 10 minutes after the programme ends. The control panel then goes out and the *Start/Add laundry* sensor flashes.

- Turn the programme selector to the  position.

-D- appears in the time display and the  indicator light goes out.

The door will unlock.

Useful tip: After the Anti-crease phase, the door will unlock automatically.

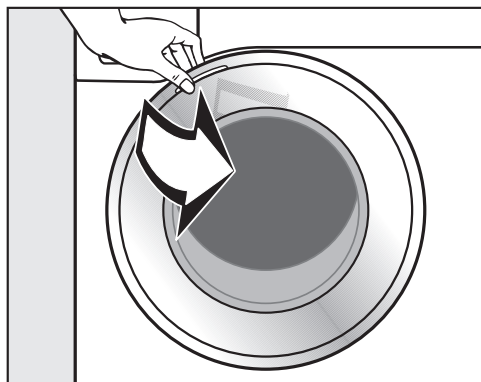

- Take hold of the door and pull it open.
- Remove the laundry.

Items left in the drum could discolour other items in the next wash or become discoloured themselves. Check that all items have been removed from the drum.

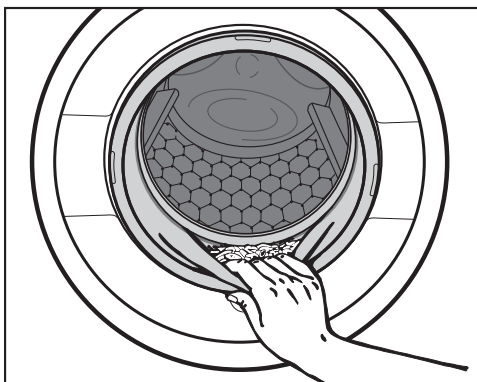

- Check the folds in the door seal for any small articles, e.g. buttons, which might be lodged there.

Useful tip: For safety reasons, close the door when the machine is not in use. Otherwise there is a danger of objects being placed inadvertently in the drum. If these remain unnoticed and were washed in the next load, they could damage the laundry. An open door is also a danger to pets and children.

- If applicable, remove the used capsule from the detergent dispenser drawer.

Useful tip: Leave the detergent dispenser drawer slightly open to allow it to dry.

Spinning

Final spin speed in wash programmes

When a programme is selected, the sensor for the optimum spin speed for that programme will be brightly lit up in the control panel.

A faster spin speed can be selected for certain wash programmes.

The highest selectable spin speed is indicated in the table.

Programme	rpm
Cottons	1400
Cottons 	1400
Minimum iron	1200
Delicates	900
Woolens 	1200
Shirts	900
QuickPowerWash	1400
Express 20	1200
ECO 40-60	1400
Proofing	1200
Drain/Spin	1400
Separate rinse/Starch	1200

Rinse and interim spin

There is a spin after the main wash and between the rinses. A reduction in the final spin speed will also reduce the interim spin speed. If a spin speed of less than 700 rpm is selected for the *Cottons* programme, an additional rinse is introduced.

Deselecting final spin (Rinse hold)

- Touch the  sensor (Rinse hold).

The laundry is not spun after the final rinse and remains in the rinse water. This helps prevent creasing if the laundry is not going to be removed from the drum immediately after the end of the programme.

Ending a programme with a spin cycle

The sensor for the optimum spin speed lights up in the control panel. You can change the spin speed.

- Touch the *Start/Add laundry* sensor.

Ending a programme without a spin cycle

- Reduce the spin speed to .
- Touch the *Start/Add laundry* sensor.

Deselecting the interim spin and the final spin

- Touch the  sensor.

After the last rinse, the water will be pumped away and the Anti-crease phase will switch on.

In some programmes an additional rinse is introduced with this setting.

With Delay start you can delay the start of a programme from 30 minutes up to a maximum of 24 hours. This allows you to make use of night-time economy electricity rates, for example.

Selecting Delay start

Delay start is not possible in the *Drain/Spin* and *Proofing* programmes.

- Select the programme required.
- Touch the  sensor.

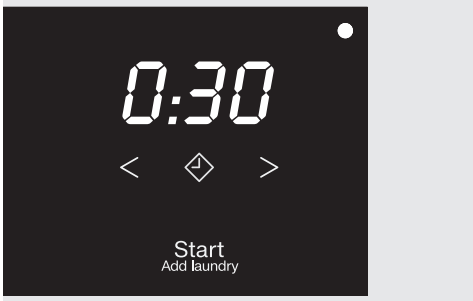

The  sensor lights up brightly.

- Touch the < or > sensor repeatedly until the required Delay start time appears in the time display.
- For less than 10 hours, the Delay start time changes in increments of 30 minutes
- For more than 10 hours, the Delay start time changes in increments of 1 hour

Starting Delay start

- Touch the flashing *Start/Add laundry* sensor.

The Delay start process starts and counts down in the time display.

Changing or cancelling a started Delay start time

If the selected Delay start function has started, it is no longer possible to change the time.



- Turn the programme selector to the  position.
- Turn the programme selector to any programme.

Rotating bars *L... L... L...* or *-0-* are shown in the time display.

The door lock is released.

- Select a programme and a new Delay start time if required.

Programme chart

Cottons 		60°C	Max. load 8.0 kg
Items	Cottons, linens or cotton mix fabrics, e.g. table linen, towelling, underwear, T-shirts etc.		
Notes	With Cottons  60°C the actual wash temperature reached will be lower than 60°C although the wash performance is the same as with the standard Cottons 60°C programme.		
Cottons 		40°C	Max. load 8.0 kg
Items	Normally soiled cotton garments.		
Notes	These settings are the most efficient in terms of energy and water consumption for washing cottons.		
Note for test institutes:			
Energy labelling programme according to AS/NZS 2040.1 & AS/NZS 2040.2 (refer to www.energyrating.gov.au website for consumption data).			
The detergent must be added via the detergent dispenser drawer.			
Cottons		Cold to 90°C	Max. load 8.0 kg
Items	Cottons, linens or cotton mix fabrics, e.g. table linen, towelling, underwear, T-shirts etc.		
Notes	Where particularly high levels of hygiene are required, please select a temperature of 60°C or higher.		
Minimum iron		Cold to 60°C	Max. load 3.5 kg
Items	Synthetic, mixed fibre and easy care cotton.		
Notes	Reduce the spin speed for fabric that creases easily.		

Programme chart

Delicates		Cold to 40°C	Max. load 2.0 kg
Items	<p>Delicate garments made from synthetic fibre, mixed fibre, rayon and viscose.</p> <p>Performance outerwear (e.g. jackets and trousers) made from membrane fabric such as Gore-Tex®, SYMPATEX®, WINDSTOPPER®, etc.</p> <p>Curtains specified as machine-washable by the manufacturer.</p>		
Notes	<ul style="list-style-type: none"> - On outdoor clothing, fasten zips or close Velcro fasteners and do not use fabric softener. - If required, these items can also be reproofed using the <i>Proofing</i> programme. Reproofing after each wash cycle is not recommended. - Dust in curtains usually means that a programme with pre-wash is advisable. - For items which crease easily, deselect the spin. 		
Woollens 		Cold to 40°C	Max. load 2.0 kg
Items	Machine-washable or hand-washable wool or wool blend fabric. If the care label does not specify a temperature, wash using the cold setting.		
Notes	Reduce the spin speed for fabrics that crease easily.		
Shirts		Cold to 60°C	Max. load 1.0 kg/2.0 kg
Items	Shirts and blouses made of cotton and mixed fibre.		
Notes	<ul style="list-style-type: none"> - Pre-treat collars and cuffs if necessary. - Wash silk shirts and blouses in the <i>Delicates</i> programme. - If the preset <i>Pre-ironing</i> Extra is switched off, the maximum load capacity is increased to 2.0 kg. 		
QuickPowerWash		40°C – 60°C	Max. load 4.0 kg
Items	Moderately soiled garments which are also suitable for washing in the <i>Cottons</i> programme.		
Notes	A special saturation process and wash rhythm ensure that the laundry is cleaned particularly quickly and thoroughly.		

Programme chart

Express 20		Cold to 40°C	Max. load 3.5 kg
Items	Cotton garments that have hardly been worn or are only very lightly soiled.		
Notes	The <i>Short Extra</i> is activated automatically.		
ECO 40-60			Max. load 8.0 kg
Items	For normally soiled cotton garments		
Notes	A laundry load consisting of mixed cottons that are intended for washing at 40°C or 60°C can be washed in the same wash cycle.		
Proofing		40°C	Max. load 2.5 kg
Items	Treating microfibre fabric, ski wear or table linen made from mainly synthetic fibres to provide a finish that is resistant to water and dirt.		
Notes	<ul style="list-style-type: none"> - The items should be freshly laundered and spun or dried before proofing. - For best results, the items should be heat-treated afterwards. This can be achieved by drying them in the tumble dryer or by ironing them. 		
Drain/Spin			—
Notes	<ul style="list-style-type: none"> - Drain only: Set spin speed to . - Make sure you select the appropriate spin speed. 		
Separate rinse/Starch			Max. load 8.0 kg
Items	<ul style="list-style-type: none"> - For rinsing hand-washed items. - For starching table cloths, serviettes and workwear. 		
Notes	<ul style="list-style-type: none"> - Reduce the spin speed for fabrics that crease easily. - Laundry that is to be starched should be washed but not treated with fabric softener. - Items will be rinsed very effectively with 2 rinses by activating the <i>Water + Extra</i>. 		

You can use the Extras sensor to augment the wash programmes.

Selecting Extras

Extras are selected and deselected using the relevant sensors on the control panel.

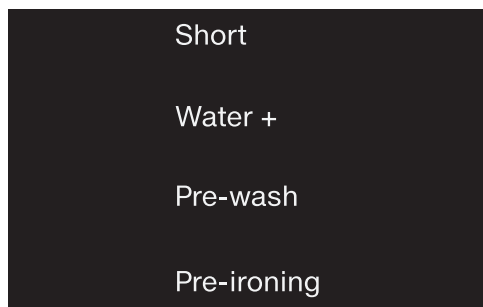

- Touch the sensor for the Extra you want.

The relevant sensor will light up brightly.

Not all Extras can be selected with every programme.

If the sensor lighting is switched off, this means the Extra cannot be selected.

The Extra cannot be activated by touch.

Short

For light soiling with no visible staining.

The wash duration is reduced.

Water +

The water level in the main wash and the rinse cycles is increased. A second rinse cycle is carried out in the *Separate rinse/Starch* programme.

You can select other functions for the *Water +* sensor. These are described under “Programmable functions”.

Pre-wash

For laundry with large amounts of dirt, e.g. dust and sand.

Pre-ironing

In order to reduce creasing, the laundry undergoes a smoothing process at the end of the programme. For optimal smoothing reduce the maximum load by 50%. Small loads achieve a better result.

The garments must be suitable for drying in a tumble dryer ☺ ☺ and suitable for ironing .

The following Extras can be selected in addition to the programme























	Short	Water +	Pre-wash	Pre-ironing
Cottons	●	●	●	●
Cottons	●	●	●	●
Minimum iron	●	●	●	●
Delicates	●	●	●	●
Woollens	–	–	–	–
Shirts	●	●	●	✓
QuickPowerWash	–	●	–	●
Express 20	✓	–	–	●
ECO 40-60	–	–	–	–
Proofing	–	–	–	–
Separate rinse/Starch	–	●	–	–

● = can be selected



✓ = activated automatically

– = cannot be selected

Programme sequence

	Main wash		Rinse		Spin
	Water level	Wash rhythm	Water level	Rinses	
Cottons 		(A)		2-5 ^{2,3}	✓
Cottons		(A)		2-5 ^{1,2,3}	✓
Minimum iron		(B)		2-4 ^{2,3}	✓
Delicates		(C)		2-4 ^{2,3}	✓
Woollens 		(E)		2	✓
Shirts		(C)		3-4 ³	✓
QuickPowerWash		(A)		2	✓
Express 20		(A)		1	✓
ECO 40-60		(A)		2-3 ²	✓
Proofing	—	(B)		1	✓
Drain/Spin	—	—	—	—	✓
Separate rinse/Starch		(B)		0-1 ⁵	✓

Please see the next page for a description of the symbols.

-  = low water level
 = medium water level
 = high water level
(A) = intensive rhythm
(B) = normal rhythm
(C) = sensitive rhythm
(E) = handwash rhythm
✓ = carried out
– = not carried out

This washing machine has fully electronic controls with automatic load control. The washing machine takes in the right amount of water required for the programme depending on the amount of laundry and its absorbency rate.



The programme sequences outlined in the chart are based on the basic programme with a full load.

Special features in the programme sequence

Anti-crease:

At the end of the programme the drum continues to turn at intervals for up to 30 minutes to help prevent creasing.

Exception: There is no Anti-crease phase in the *Woolens*  programme. The door can be opened at any time during the Anti-crease phase.

- ¹ If a temperature of 60°C or higher is selected, two rinses are carried out. If a temperature of less than 60°C is selected, three rinses are carried out.
- ² An additional rinse is carried out if:
 - there is too much foam in the drum.
 - a spin speed lower than 700 rpm has been selected.
- ³ An additional rinse is carried out if:
 - the *Water + Extra* has been selected and the options  or  have been activated in Programmable functions.
- ⁵ An additional rinse is carried out if:
 - the *Water + Extra* has been selected.

Programme sequence

PowerWash

PowerWash is a washing technique developed by Miele. It is activated in the following programmes:

- Cottons (with small and medium-sized loads)
- Minimum iron
- Shirts
- Delicates
- *ECO 40-60* (with small and medium-sized loads)

How it works

Conventional washing techniques wash with more water than the laundry can absorb. This total volume of water needs to be heated.

The PowerWash washing technique only uses slightly more water than the laundry can absorb. The water which has not been absorbed by the laundry heats up the drum and the laundry and is sprayed into the laundry over and over again. This reduces the amount of energy used.

Activation

PowerWash is activated **automatically** in the programmes listed above.

PowerWash is deactivated if:

- The selected final spin speed is less than 600 rpm
- CapDosing (☹, ☹) has been selected for the main wash
- The wash temperature is higher than 60°C
- Extras such as *Pre-wash* or *Water +* have been selected
- A large load is being washed in the *Cottons* programme

Special features

- Drenching phase

The washing machine will spin a few times at the beginning of the programme. During spinning, the water discharged is sprayed back into the laundry in order to achieve optimum moisture penetration.

The optimum water level is set at the end of the drenching phase. If necessary, the washing machine will pump water away and take in a little more fresh water.

- Noises during the heating phase

Unusual bubbling noises can occur while the laundry and the drum are being heated.

Changing the programme (safety lock)





It is not possible to change the programme, the temperature, the spin speed or the selected Extras after the programme has started. This prevents the appliance being operated unintentionally, e.g. by children.

If the washing machine is switched off during active programme operation, the standby function does not switch the washing machine off completely after 15 minutes. Safety functions continue to be active because there may still be water inside the drum.

Cancelling a programme

You can cancel a programme at any time after it has started.

- Turn the programme selector to the  position.
- Turn the programme selector to any position.

Rotating bars ...  ...  or  are shown in the time display.

The water is pumped away and the door lock is released.

Selecting a new programme

- Turn the programme selector to the required programme.
- Check that there is still detergent in the dispenser drawer. Add more detergent if necessary.
- Touch the *Start/Add laundry* sensor.

Garment care label symbols

Washing	
The figure quoted in the bucket is the maximum temperature at which the garment can be washed.	
	Normal agitation
	Reduced agitation
	Much reduced agitation
	Hand wash
	Do not wash

Programme selection examples

Programme	Garment care label symbols
Cottons	
Minimum iron	
Delicates	
Woollens	
Express 20	

Drying	
	Normal temperature
	Low temperature
	Do not tumble dry

Ironing	
	Approx. 200 °C
	Approx. 150 °C
	Approx. 110 °C Ironing with steam can cause irreversible damage.
	Ironing prohibited

Professional cleaning	
	Dry clean only. The letters indicate the type of cleaning agent required.
	Wet cleaning
	Dry cleaning prohibited

Bleaching	
	Any oxidation bleach can be used
	Use oxygen bleach only
	Do not bleach

The correct detergent

All detergents produced for automatic front loading washing machines are suitable. Follow the manufacturer's instructions and dosage recommendations on the packaging.

The right amount to dispense will depend on the following:

- The soiling level of the laundry.
- The quantity of laundry.
- The water hardness level. Check with your local water authority if you do not know the water hardness level in your area.

Detergent dispensing aids

Use dispensing aids (e.g. balls) if these are supplied with the detergent, particularly when using liquid detergent.

Refill packs of detergent

When purchasing detergent, buy refill packs wherever possible. This helps reduce the amount of waste packaging.

Colour run and dye removers/dyes

 Damage due to colour run/dye removers.

Colour run and dye removers can cause corrosion in the washing machine.

Do not use colour run or dye removers in this washing machine.

Dyes suitable for use in domestic washing machines can be used. However, please note that the salt used in the dyeing process can cause corrosion to stainless steel components in the machine if you use dye frequently. Always observe the manufacturer's instructions carefully.

When using the machine to dye fabric, it is essential to select the *Water + Extra*.

Using detergent tablets or pods

Always put detergent tablets or pods directly in the drum with the laundry. They cannot be added via the detergent dispenser drawer.

Fabric softeners and liquid starch

Fabric softeners

make garments soft to handle and help prevent static cling when tumble drying.

Fabric shapers

are synthetic starches and give an even stiffer hold.





Starch

stiffens and gives body to items of laundry, e.g. shirts, tablecloths and bed linen.

Detergent

Detergent recommendations (according to Ecodesign no. 2019/2023)

The recommendations apply across the entire temperature range of the wash programmes.

	UltraWhite	UltraColor	 Miele capsules	 Miele capsules	 Miele capsules	Universal detergent	Colour detergent	Detergent for delicates and woollens	Special-purpose detergent
Cottons 	✓	✓		✓	✓	✓	✓		
Cottons	✓	✓		✓	✓	✓	✓		
Minimum iron		✓		✓	✓		✓		
Delicates			✓	✓				✓	
Woollens 			✓					✓	✓
Shirts	✓	✓		✓	✓	✓	✓		
QuickPowerWash	✓	✓				✓	✓		
Express 20		✓		✓			✓ ¹		
ECO 40-60	✓	✓		✓	✓	✓	✓		
Proofing				✓					
Separate rinse/Starch				✓/–					

✓ recommended

 Specialist detergents (e.g. WoolCare)

¹ Liquid detergent

 Fabric care (e.g. fabric softener)

² Powder detergent

 Additive (e.g. booster)

External casing and fascia panel

⚠ Risk of electric shock!

Mains voltage is present when the washing machine is switched off. Disconnect the machine from the electricity supply before cleaning or maintenance.

⚠ Risk of damage due to ingress of water.

The pressure of a water jet can cause water to get into the washing machine, resulting in damage to components.

Do not spray the washing machine with a water jet or high pressure hose.

- Clean the casing and control panel with a mild cleaning agent or soap and water and dry both with a soft cloth.
- The drum can be cleaned using a suitable stainless steel cleaning agent following the manufacturer's instructions on the packaging.

⚠ Damage caused by cleaning agents.

Solvent based cleaning agents, abrasive cleaners, glass cleaners or multi-purpose cleaning agents can cause damage to plastic surfaces and other parts.

Do not use any of these cleaning agents.

Cleaning the detergent dispenser drawer

Washing at low temperatures and the use of liquid detergent can lead to a build-up of mould and bacteria in the detergent dispenser drawer.

- For hygiene reasons, clean the entire drawer at regular intervals.

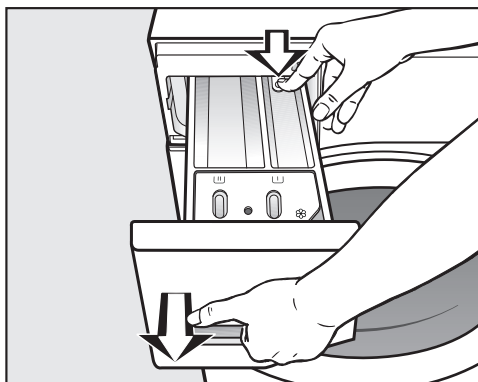

Removing the detergent dispenser drawer





- Pull out the detergent dispenser drawer until a resistance is felt. Press down the release button and at the same time pull the drawer right out of the machine.
- Clean the detergent drawer with warm water.

Cleaning and care

Cleaning the siphon and the / compartment channel

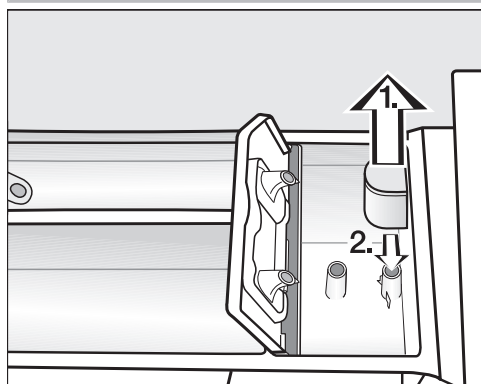
Liquid starch results in clogging. If clogged, the siphon in the /  compartment will not work and the compartment can overflow. Clean the siphon particularly thoroughly after using liquid starch a few times.



1. Remove the siphon from the  compartment and clean under warm running water. Clean the siphon tube in the same way.
2. Refit the siphon.

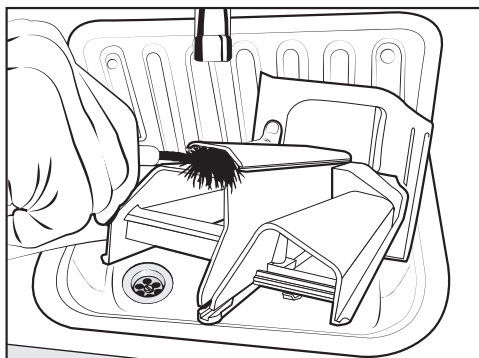

- Clean the fabric softener channel using a brush and warm water.

Cleaning the detergent dispenser drawer housing

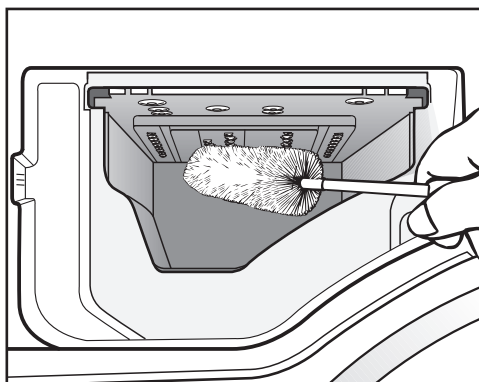

- Use a bottle brush to remove detergent residues and limescale from the jets inside the detergent dispenser drawer compartment.
- Replace the detergent dispenser drawer.

Useful tip: To assist drying, leave the detergent dispenser drawer slightly open.

Hygiene info (Cleaning the drum)

Washing at low temperatures and/or using liquid detergent can cause bacteria and unpleasant odours to build up in the washing machine. Use the *Cottons* 90 °C programme to clean the washing machine. This should be done at the latest when the indicator light  comes on.

Cleaning the water inlet filter

The washing machine has 2 filters to protect the inlet valve. Check these filters every 6 months or so. Perform this check more often if there are frequent interruptions to the external water supply.

Cleaning the filter in the inlet hose

- First turn off the tap.
- Unscrew the inlet hose.

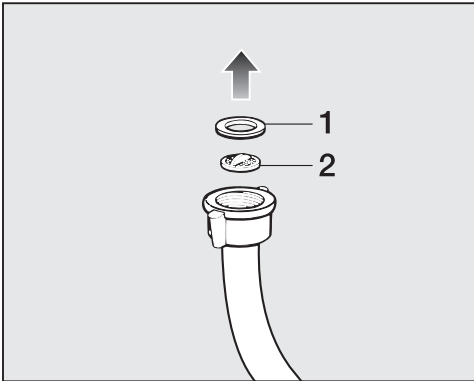

- Remove the rubber seal **1** from the recess.
- Using pointed pliers, take hold of the plastic filter bar **2** and remove the plastic filter.
- Clean the filter and the seal.

- Reassemble the filter and seal in the reverse order and reconnect the hose.

Cleaning the filter in the inlet valve

- Using pliers, carefully loosen the ribbed plastic nut (seal) on the inlet valve and unscrew it.

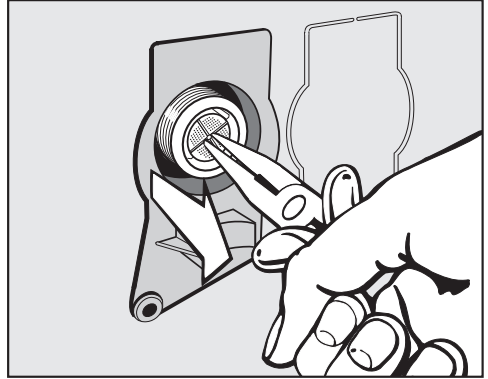

- Use pointed pliers to withdraw the plastic filter by the bar (see illustration).
- Clean the filter and the plastic nut (seal).
- Put the filter and plastic nut (seal) back in the reverse order and reconnect the hose.

The filters must be put back in place after cleaning.

- Turn on the tap.

Make sure there is no water leaking from the connections.

Problem solving guide

Many malfunctions and minor faults that can occur in daily operation can be corrected without contacting Miele. This will save you time and money because you will not need a service call.



You can find information on how to remedy faults yourself at www.miele.com.au/service or www.miele.co.nz/service and on the Miele website.

Please note, however, that a call-out charge will be applied to unnecessary service visits where the problem could have been rectified as described in these operating instructions.

The programme does not start

Problem	Possible cause and remedy
The control panel remains dark.	There is no power to the machine. <ul style="list-style-type: none">■ Check whether the mains plug is plugged in and switched on.■ Check whether the circuit breaker has tripped.
	The washing machine has switched off automatically to save energy. <ul style="list-style-type: none">■ Switch the washing machine on again by turning the programme selector.
F and 34 alternately appear in the time display.	The door is not closed properly. The door lock could not engage. <ul style="list-style-type: none">■ Close the door again.■ Start the programme again. If the fault message appears again, contact Miele.

The programme is cancelled and a fault indicator light lights up in the control panel.

Problem	Possible cause and remedy
The fault indicator light  lights up, F and // appear alternately in the time display and the buzzer sounds.	The water outlet is blocked or restricted. The drain hose has been fixed too high. <ul style="list-style-type: none">■ Clean the drain filter and the pump.■ The maximum drain height is 1 m.
The fault indicator light  lights up, F and ID appear alternately in the time display and the buzzer sounds.	The water inlet is blocked or restricted. <ul style="list-style-type: none">■ Check whether the tap is turned on properly.■ Check whether the inlet hose is kinked.■ Check whether there is sufficient water pressure.
	The filter in the water inlet is blocked. <ul style="list-style-type: none">■ Clean the filter.



Problem solving guide

Problem	Possible cause and remedy
The fault indicator light  lights up, <i>F</i> and <i>138</i> appear alternately in the time display and the buzzer sounds.	The water protection system has reacted. <ul style="list-style-type: none"> ■ Turn off the tap. ■ Call Miele.
<i>F</i> and <i>XXX</i> appear alternately in the time display and the buzzer sounds.	There is a fault. <ul style="list-style-type: none"> ■ Disconnect the washing machine from the electricity supply. Switch off at the wall and withdraw the plug from the socket, or switch off the mains circuit breaker. ■ Wait at least 2 minutes before reconnecting the washing machine to the electricity supply. ■ Then switch the washing machine on again. ■ Restart the programme. <p>If the fault message appears again, contact Miele.</p>

During the programme, a symbol appears in the time display

Message	Possible cause and remedy
-U- lights up	The programme selector was moved to a different position after the programme had started. <ul style="list-style-type: none"> ■ Turn the programme selector back to the original position.

At the end of the programme, an indicator light lights up in the control panel

Problem	Possible cause and remedy
The indicator light  lights up.	Excessive foam has built up during washing. <ul style="list-style-type: none"> ■ Use less detergent next time and follow the manufacturer's instructions on dosage given on the packaging.
The indicator light  lights up.	When washing, a wash programme using a temperature above 60°C has not been run for a long time. <ul style="list-style-type: none"> ■ Run the <i>Cottons</i> 90°C programme using Miele IntenseClean machine cleaner or a universal powder detergent. <p>This will clean the washing machine and prevent a build-up of bacteria and odours.</p>

Problem solving guide

Problem	Possible cause and remedy
F and 37 alternately appear in the time display.	<p>The <i>Pre-ironing</i> Extra which runs at the end of the programme could not be carried out properly.</p> <ul style="list-style-type: none"> ■ Check whether the washing machine is aligned correctly (see "Installation – Levelling the machine"). ■ Check whether the maximum drain height of 1 m has been exceeded.
	<p>If the fault message appears again, contact Miele. The washing machine can still be used, but without the <i>Pre-ironing</i> Extra.</p>



General problems with the washing machine

Problem	Possible cause and remedy
The washing machine smells.	<p>The ☒ indicator light was ignored. A programme using a temperature above 60°C has not been run for a long period of time.</p> <ul style="list-style-type: none"> ■ In order to prevent bacteria and unpleasant odours building up in the machine, run the <i>Cottons</i> 90°C programme using Miele IntenseClean or powder detergent.
	<p>The detergent dispenser drawer was left closed after washing.</p> <ul style="list-style-type: none"> ■ Leave the detergent dispenser drawer slightly open to allow it to dry.
The machine shakes during the spin cycle.	<p>The machine feet are not level.</p> <ul style="list-style-type: none"> ■ Level the machine and adjust the feet correctly.
The laundry has not been spun properly and the laundry is still wet.	<p>The machine detected an imbalance during the final spin and reduced the spin speed automatically.</p> <ul style="list-style-type: none"> ■ Include both large and small items in the load as this will give better distribution.
The pump makes strange noises.	<p>This is not a fault. These slurping noises occur at the end of the pump sequence as a normal part of operation.</p>

Problem solving guide

Problem	Possible cause and remedy
Large amounts of detergent residue remain in the detergent dispenser drawer.	<p>The water pressure is too low.</p> <ul style="list-style-type: none"> ■ Clean the filter in the water inlet. Please note that the water pressure must be at least 100 kPa (1 bar). ■ It may be useful to select the <i>Water + Extra</i>.
	<p>Powder detergent used with water softeners can be sticky.</p> <ul style="list-style-type: none"> ■ Clean the detergent dispenser drawer and in future add washing powder and then add the water softener.

General problems with the washing machine



Problem	Possible cause and remedy
Fabric softener is not completely dispensed or too much water remains in the  compartment.	<p>The siphon tube is not correctly positioned, or is clogged up.</p> <ul style="list-style-type: none"> ■ Clean the siphon (see “Cleaning and care - Cleaning the detergent dispenser drawer”).
At the end of the programme there is still liquid in the capsule.	<p>The small pipe in the detergent dispenser drawer onto which the capsule is placed is blocked.</p> <ul style="list-style-type: none"> ■ Clean the small pipe.
	<p>This is not a fault. For technical reasons, a small amount of water will remain in the capsule.</p>
There is water next to the capsule in the fabric softener compartment.	<p>The  sensor was not activated.</p> <ul style="list-style-type: none"> ■ Make sure that you remember to activate the  sensor the next time you insert a capsule.
	<p>An empty capsule was not removed at the end of the last wash programme.</p> <ul style="list-style-type: none"> ■ Remove and dispose of the empty capsule at the end of each programme.
	<p>The small pipe in the detergent dispenser drawer onto which the capsule is placed is blocked.</p> <ul style="list-style-type: none"> ■ Clean the small pipe.

Problem solving guide

An unsatisfactory wash result

Problem	Possible cause and remedy
Liquid detergent does not give the required result.	Liquid detergents usually contain no bleaching agents. They do not remove fruit, coffee and tea stains. <ul style="list-style-type: none">■ Use a general purpose powder detergent containing a bleaching agent.■ Use the appropriate capsule or add stain removers to the  compartment.■ Never put stain removers and liquid detergent together in the dispenser drawer.
Grey, greasy particles cling to washed laundry.	Insufficient amounts of detergent were used to break down the particles of grease in heavily soiled laundry. <ul style="list-style-type: none">■ Use more detergent or liquid detergent.■ Before washing the next load, run a <i>Cottons 60°C</i> programme with powder detergent but without a load.
White residues which look like powder detergent are seen on dark textiles after washing.	The detergent contained compounds (zeolites) to aid water softening which are not soluble in water. These have ended up on the laundry. <ul style="list-style-type: none">■ Try and brush off the residues with a soft brush once the laundry is dry.■ Wash dark textiles using a detergent which does not contain zeolites. Liquid detergents usually do not contain zeolites.

The door will not open

Problem	Possible cause and remedy
The door cannot be pulled open during a programme.	The drum is locked during a programme. <ul style="list-style-type: none">■ Follow the instructions in "5. Starting the programme – Adding laundry during a programme sequence".
After the programme is cancelled, flashing bars ......... appear in the time display.	For safety reasons, the door cannot be opened if the suds temperature is higher than 55°C. <ul style="list-style-type: none">■ Wait until the temperature in the drum has decreased and the bars have stopped flashing in the display.
F and 35 alternately appear in the time display.	The door lock has jammed. <ul style="list-style-type: none">■ Call Miele.

Opening the door in the event of a blocked drain outlet and/or power cut

- Switch off the washing machine.



- Open the access panel for the drain pump.

Blocked drain outlet

If the drain outlet is blocked, a larger quantity of water can remain in the washing machine.

 Risk of scalding due to hot suds. Escaping suds will be hot if laundry has been washed at high temperatures!
Carefully allow all suds to drain off.

Procedure for draining the machine

When removing the drain filter, do not remove it completely.

- Place a suitable container under the access panel, e.g. a universal oven tray.

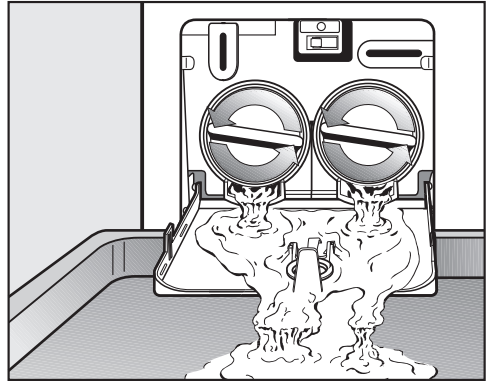

- Slowly and carefully unscrew the filters until water runs out. Be careful not to release too much water at once. If the flow of water is too strong, some water can seep into the machine base and activate the water protection system. This will prevent the machine from functioning.
- To interrupt the flow of water, tighten the filters again.

Once the flow of water ceases:

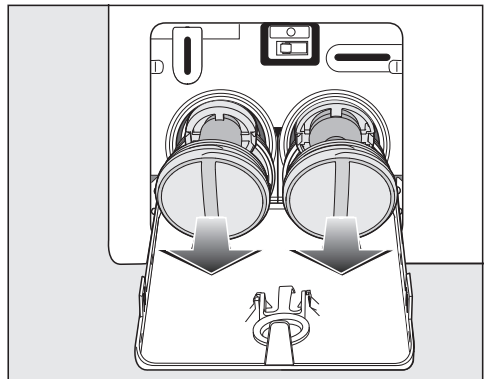

- Remove the filters completely.

Problem solving guide

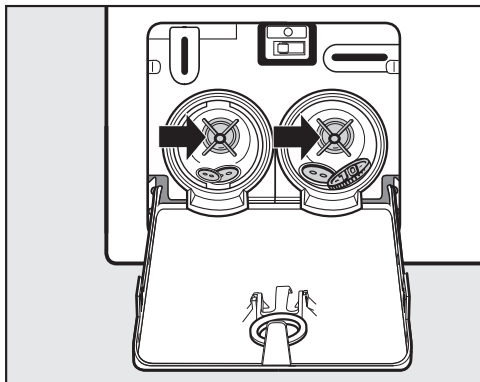

- Clean the filters thoroughly.
- Remove any foreign objects (e.g. buttons, coins etc.) and clean the interior. Turn the impellers by hand to check that they rotate freely.

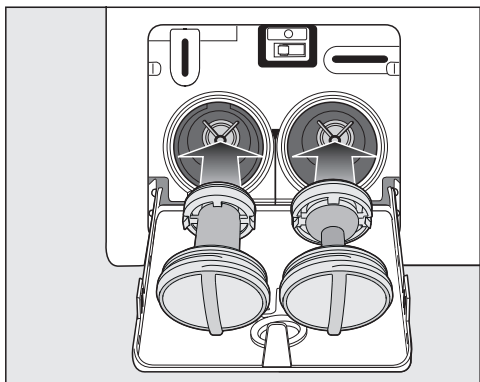

- Replace the filters correctly (on the right and left) and tighten them.
- Close the access panel for the drain pump.

⚠ Risk of water damage.
Make sure the drain filters are securely tightened. Otherwise there is a risk of water leakage during use. Replace the drain filters correctly and tighten them securely. Close the access panel for the drain pump.

Opening the door

⚠ Danger of injury due to rotating drum!
Reaching into a moving drum is extremely dangerous. Danger of injury!
Always make sure that the drum is stationary before reaching in to remove laundry.

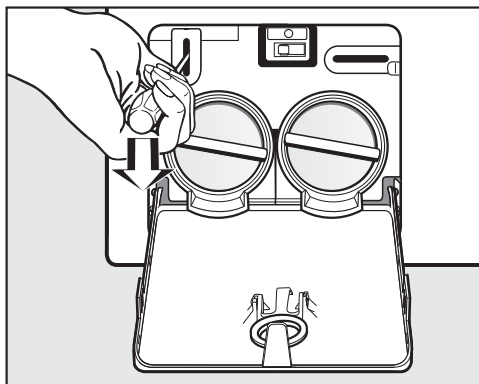

- Use a screwdriver to unlock the door of the machine as shown.
- Pull open the door.

You can find information on how to remedy faults yourself and about Miele spare parts at www.miele.com.au/service or www.miele.co.nz/service.

Contact in case of fault

In the event of any faults which you cannot remedy yourself, please contact Miele.

You can book a Miele customer service call-out online at www.miele.com.au/service or www.miele.co.nz/service.

Contact information for Miele can be found at the end of this booklet.

Please quote the model and serial number of your appliance when contacting Miele. This information can be found on the data plate.

The data plate is found above the porthole glass when the door is opened.

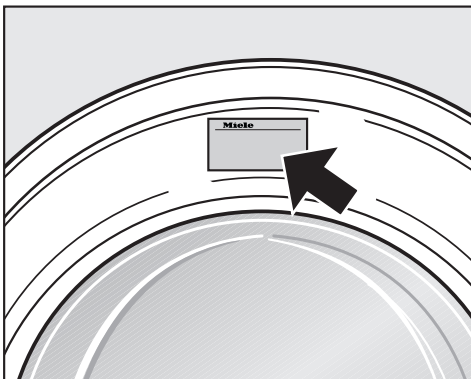

Optional accessories

Optional spare parts and accessories for this washing machine are available from Miele.

Warranty

The manufacturer's warranty for this appliance is 2 years.

For further information, please refer to your warranty booklet.

Installation

Front view

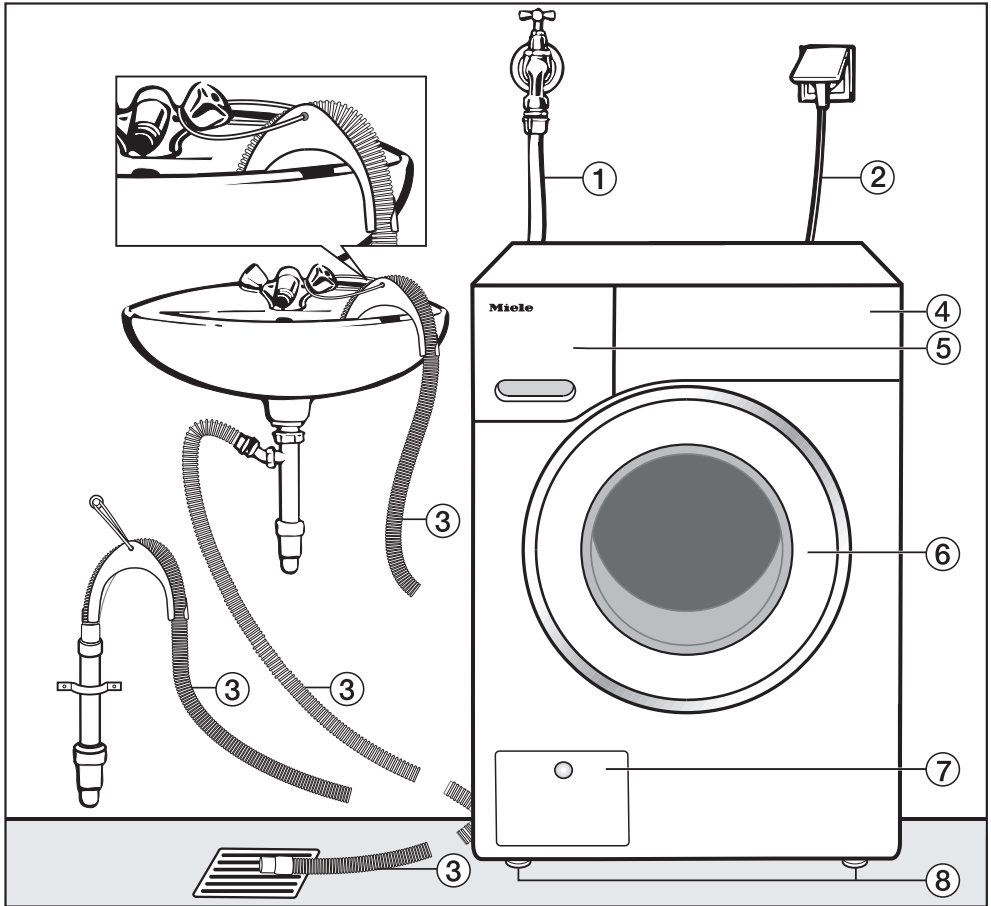

- ① Inlet hose (tested to withstand pressures up to 7000 kPa)
- ② Electrical connection
- ③ Flexible drain hose (with detachable swivel elbow)
- ④ Control panel

- ⑤ Detergent dispenser drawer
- ⑥ Door
- ⑦ Access to filters, pumps and emergency release
- ⑧ Four height-adjustable feet

Rear view

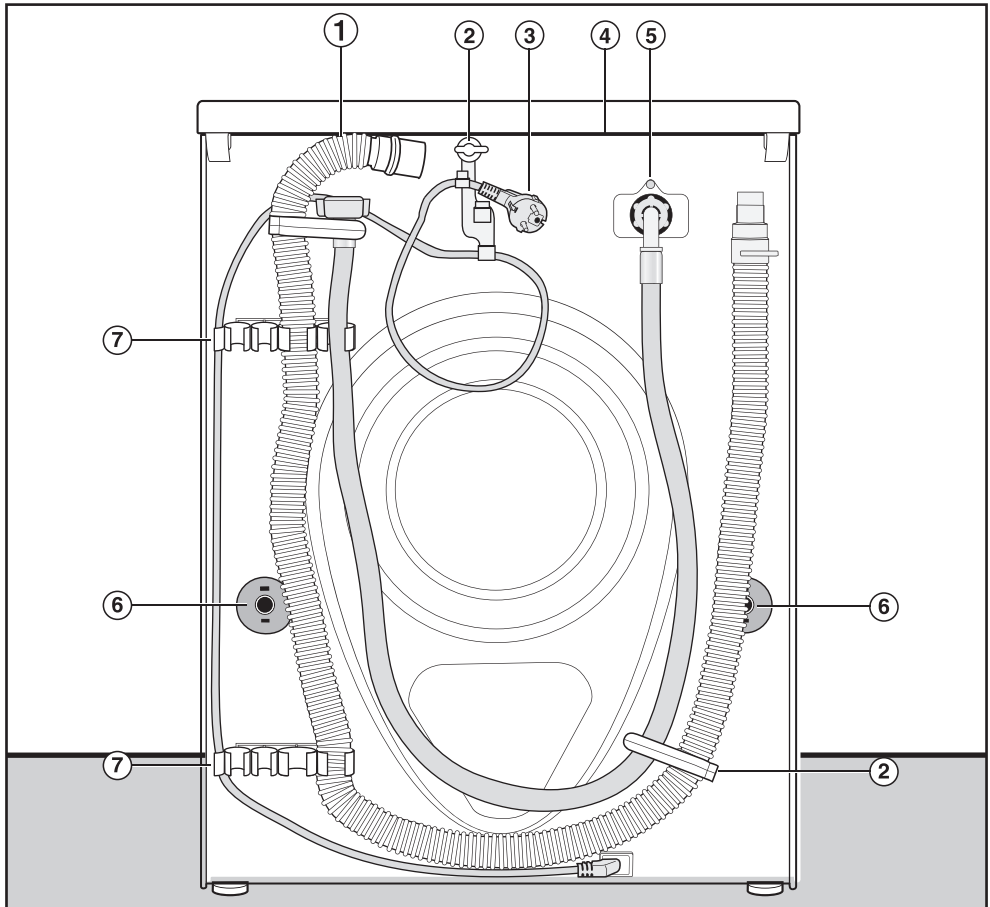

- ① Drain hose
- ② Transport clips for inlet and drain hoses and mains connection cable
- ③ Electrical connection
- ④ Protruding lid for holding when moving the machine

- ⑤ Inlet hose (tested to withstand pressures up to 7000 kPa)
- ⑥ Safety caps for transit bars
- ⑦ Transport clips for inlet and drain hoses and for storing transit bars when not in use

Installation

Installation surface

A concrete floor is the most suitable installation surface. It is far less prone to vibration during the spin cycle than wooden floorboards or a carpeted surface.

Please note:

- The machine must be level and securely positioned.
- To avoid vibrations during spinning, the machine should not be installed on soft floor coverings.

If installing on a wooden joist floor:

- Install the machine on a plywood base (at least 59 x 52 x 3 cm). The base should span several joists and be bolted to the joists and not only to the floorboards. Check for the presence of pipes and cables first.

Useful tip: If possible, install the machine in a corner. This is usually the most stable part of the floor.

Transporting the washing machine to its installation site

 Danger of injury due to unsecured lid.

Make sure the fixings at the back of the lid are secure. They may become brittle due to external circumstances. There is a danger of the lid being pulled off when carrying the appliance.

Before carrying the appliance, check that the lid is secure where it protrudes at the back.

- Carry the washing machine by the front feet and by the lid where it protrudes at the back of the appliance.

Removing the transit bars

Removing the left transit bar

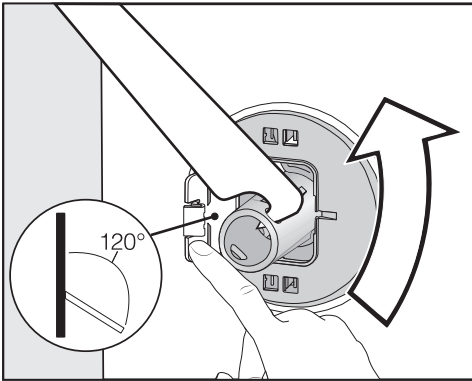

- Push the flap outwards and turn the transit bar 90° using the enclosed spanner.

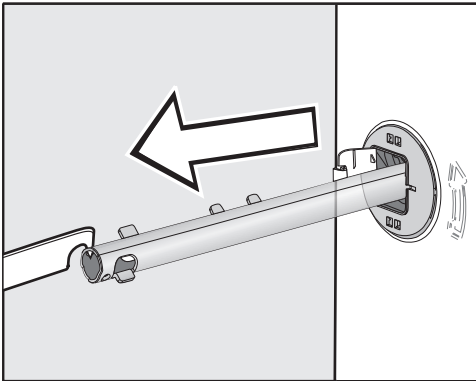

- Then pull the transit bar out.

Removing the right transit bar

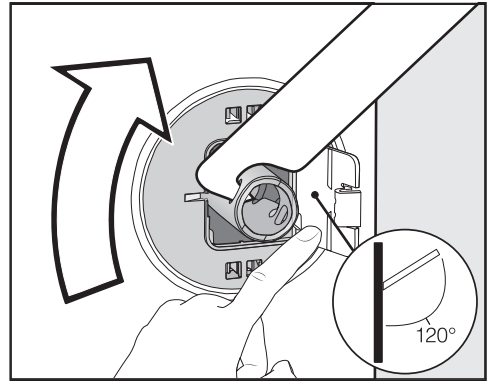

- Push the flap outwards and turn the transit bar 90° using the enclosed spanner.



- Then pull the transit bar out.

Installation

Covering the holes

 Risk of injury from sharp edges!
There is a risk of injury from reaching into holes that are not covered.
To avoid the risk of injury, the holes for the transit bars must be covered after the transit bars have been removed.

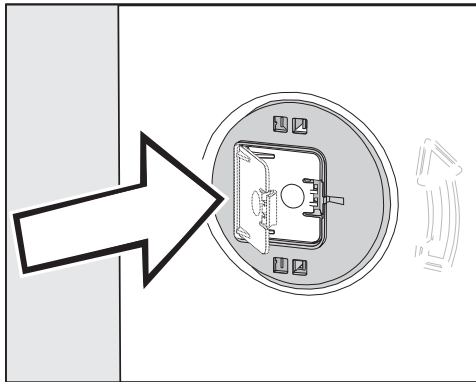

- Press the flaps firmly shut until they click into place.

Securing the transit bars

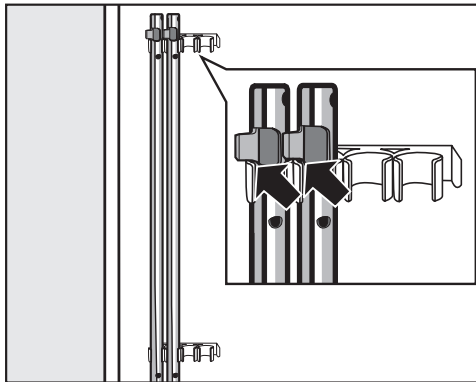

- Secure the transit bars to the back of the washing machine. Make sure that the top catch is located above the holder.

 Risk of damage from incorrect transport.
The washing machine may become damaged if moved without the transit bars in place.
Keep the transit bars in a safe place.
Fit them again if the machine is to be moved (e.g. when moving house).

Fitting the transit bars

Opening the flaps

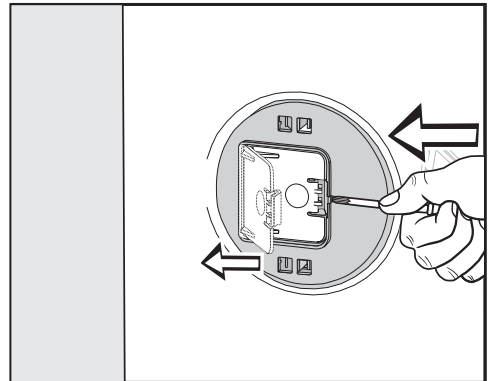

- Push against the catch with a pointed object, e.g. a narrow screwdriver.

The flap will open.

Fitting the transit bars

- Install the transit bars in reverse order to their removal.

Useful tip: If you lift the drum slightly, the transit bars can be pushed in more easily.

Levelling the machine

The washing machine must stand perfectly level on all four feet to ensure safe and proper operation.

Incorrect installation may increase electricity and water consumption and may cause the machine to move about.

Screwing out and adjusting the feet

The four adjustable screw feet are used for levelling the washing machine. All four feet are screwed in when the appliance is delivered.

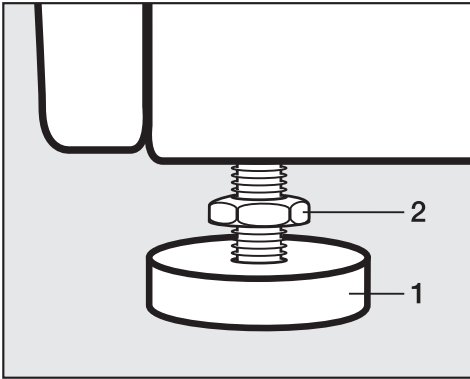

- Using the spanner supplied, turn counter nut **2** in a clockwise direction. Then turn counter nut **2** together with foot **1** to unscrew.



- Use a spirit level to check that the washing machine is standing level.
- Hold foot **1** securely with a pipe wrench. Turn counter nut **2** again using the spanner supplied until it sits firmly up against the housing.

⚠ Risk of damage due to incorrectly aligned washing machine.

There is a danger of the washing machine moving about if the feet are not secured.

Turn all four counter nuts for the feet until they sit firmly up against the housing. Please also check this for the feet which did not need adjustment.

Installation

Installing under a continuous worktop

 Risk of electric shock due to exposed cables.

There is a risk of coming into contact with live parts while the lid is removed.

Do not remove the washing machine lid.

This washing machine (with lid intact) can be pushed under a worktop if there is space to do so.

Plinth

The washing machine can be installed on a plinth with drawer (please note the plinth may not be available in all countries).

The plinth must be purchased as a pair and secured to the second plinth supporting another tumble dryer or washing machine.

Washer and dryer stack

A Miele tumble dryer can be stacked with the washing machine. The appropriate “WTV” stacking kit* to match your tumble dryer is required.

All parts marked * are available from Miele.

Please note:

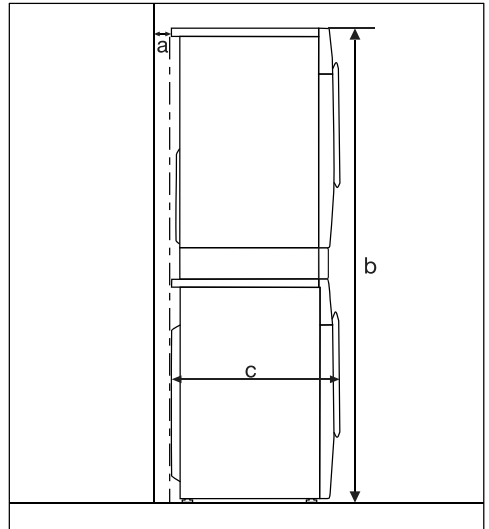

a = at least 2 cm

b = WTV without drawer: 172 cm
WTV with drawer: 181 cm

c = 65 cm

The Miele water protection system

The Miele water protection system protects all parts of the washing machine and surrounds from water damage.

The system consists of three main components:

- the inlet hose
- the electronic unit and drainage and overflow protection
- the drain hose

Inlet hose

- Protection against bursting
The inlet hose is tested to withstand pressures up to 7000 kPa.

Electronic unit and machine housing

- Sump: any leaking water from the washing machine is collected in the floor tray. There is a float switch to close the water intake valve. The water inlet is shut off and any water inside the suds container is drained away.
- Leak protection: any leaking water that is not collected in the sump is detected. The water inlet is shut off and any water inside the suds container is drained away.
- Overflow protection: this prevents the washing machine from taking in too much water and overflowing. If the water level exceeds a certain level, the drain pump switches on and pumps the excess water away in a controlled way.

Drain hose

The drain hose is protected by a ventilation system which prevents the washing machine from being emptied completely.

Connection to the water supply

 Health risk and risk of damage due to contaminated mains water. The quality of the water used must correspond to the drinking water specification of the country in which the washing machine is being operated. Always connect the washing machine to potable water.

The washing machine must be connected to a mains water supply in accordance with current local and national safety regulations.

The water connection pressure needs to be between 100 kPa (1 bar) and 1000 kPa (10 bar). If the water connection pressure exceeds 1000 kPa, a pressure reducing valve must be installed.

A tap with a $\frac{3}{4}$ inch threaded union is required for the connection. If this is not available, only a qualified plumber may connect the washing machine to the mains water supply.

The washing machine is not suitable for connection to a hot water supply.

Installation

Connecting the water inlet hose

- Screw the water inlet hose with the nut onto the thread of the tap.
- Slowly turn on the tap and check the connection for leaks.
- Correct the position of the seal and screw thread if necessary.

Maintenance

Only use a genuine Miele hose should you ever need a replacement. These are tested to withstand pressures up to 7000 kPa.

 A filter is located in the open end of the inlet hose and another in the intake point to protect the inlet valve. The filters must remain in place, and be replaced after cleaning.

Hose extension

Longer hoses 2.5 m or 4.0 m in length are available from Miele as optional accessories (depending on country).

Drainage

The suds are drained through a drain pump with a 1 m high delivery head. For the water to drain freely, the hose must be free of kinks.

If required, the hose can be extended to a length of up to 5 m. The necessary parts can be ordered from Miele (depending on country).

For a delivery head of more than 1 m (up to a max. of 1.8 m), a replacement drain pump will need to be fitted. Please contact Miele for advice.

For a delivery head of 1.8 m, the hose can be extended to a length of up to 2.5 m. The necessary parts can be ordered from Miele (depending on country).

Drain hose connection options

1. Directed into a laundry trough or tub or into the sud-saver pipe of a laundry trough or tub.

Please note:

- Hook the hose over the edge and secure it.
- Make sure that the water can drain away freely without hindrance. Otherwise there is a risk of water overflowing or of some of the drained water being sucked back into the machine.

2. Connected securely to a trapped waste pipe.
3. Connected securely to a floor drain (gully).

Using the elbow

To prevent the drain hose from slipping, use the enclosed elbow.

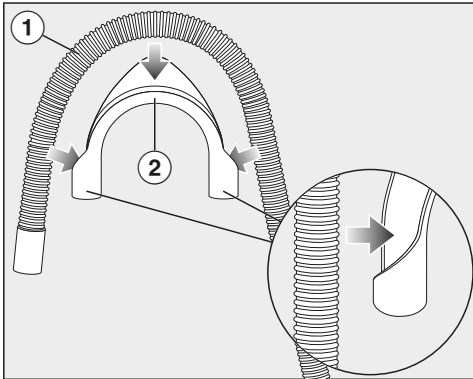

- Attach the elbow (2) to the drain hose (1).

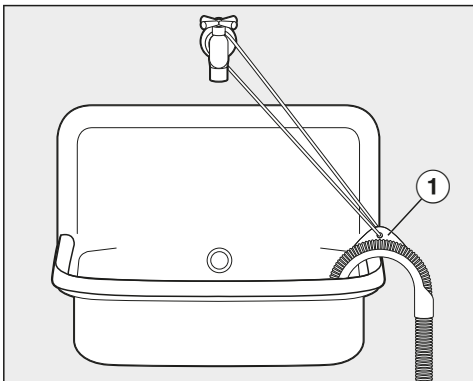

- Hang the drain hose over the sink.
- Secure the elbow from slipping using a strap and the eyelet (1).

Direct connection to a sink drain outlet

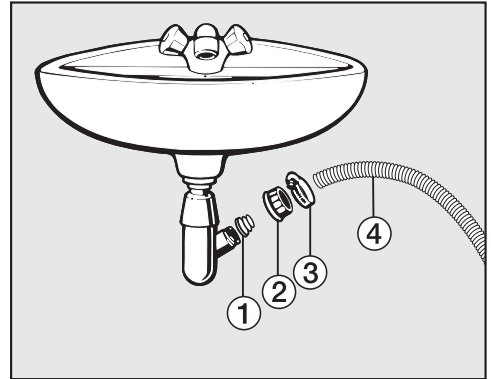

- ① Adapter
- ② Washbasin nut
- ③ Hose clip
- ④ End of the hose

- Fit the adapter (1) to the sink drain outlet using the nut (2).
- Attach the end of the hose (4) to the adapter (1).
- Use a screwdriver to tighten the hose clip (3) up close to the nut.

Installation

Electrical connection

The washing machine is supplied with a mains cable with moulded plug ready for connection to a switched socket.

The socket should be easily accessible after the machine has been installed. If the switch is not accessible after installation, an additional means of disconnection must be provided for all poles.

 Risk of fire from overheating!

Connecting the washing machine to a multi-socket plug adapter or to an extension lead can overload the cable.

Do not use an extension lead or multi-socket plug adapter.

All electrical work must be carried out by a suitably qualified and competent person, in strict accordance with national and local safety regulations.

For extra safety, it is advisable to install a suitable residual current device (RCD) with a trip current of 30 mA. Ensure power is not supplied to the appliance until after the installation has been completed.

If the mains connection cable is damaged, it must only be replaced with a specific mains connection cable of the same type (available from Miele). For safety reasons, such replacement may only be carried out by a suitably qualified and competent technician or by a Miele authorised service technician, in order to avoid a hazard.

The data plate indicates the nominal power consumption and the appropriate fuse rating. Compare this information with the data of the on-site electrical connection.

If in any doubt, consult a qualified electrician.

Temporary or permanent operation with a self-sufficient or non-mains synchronous energy supply system (e.g. isolated networks, back-up systems) is possible. A requirement for the operation is that the energy supply system complies with all current local and national requirements that apply to stand-alone, solar and/or battery systems.

The protective measures provided in the domestic installation and in this Miele product must also be assured in their function and operation in isolated operation or in non-mains synchronous operation, or replaced with equivalent measures in the installation.

Technical data

Height	850 mm
Width	596 mm
Depth	643 mm
Depth with door open	1077 mm
Height for building under	850 mm
Width for building under	600 mm
Weight	Approx. 90 kg
Capacity	8.0 kg dry laundry
Supply voltage	see data plate
Rated load	see data plate
Fuse rating	see data plate
Minimum water flow pressure	100 kPa (1 bar)
Maximum water flow pressure	1000 kPa (10 bar)
Water inlet hose length	1.60 m
Drain hose length	1.50 m
Mains connection cable length	2.00 m
Drain pump head height max.	1.00 m
Drain pump length max.	5.00 m
LEDs	Class 1
Test certifications awarded	see data plate
Power consumption when switched off	0.40 W

Consumption data

Programmes	Load kg	Energy kWh	Water Litres	Duration h:min	Temperature ¹ °C	Residual moisture %	Speed rpm
Cottons	60	1.35	57	2:29	55	53	1400
	20	0.40	72	2:39	20	53	1400
Minimum iron	30	0.45	52	1:59	30	30	1200
	40	0.34	30	0:20	29	60	1200
Woollens 	30	0.23	35	0:38	–	–	1200
QuickPowerWash	40	0.58	40	0:49	–	–	1400

¹ Maximum laundry temperature reached in main wash.

² *Short* Extra activated

Information for customers:

Consumption data can vary from the nominal values listed depending on water pressure, water hardness, water inlet temperature, room temperature, type and volume of load, fluctuations in the electricity supply and any Extras selected.

The programmable functions are used to alter the machine's electronics to suit changing requirements. Programmable functions can be altered at any time.

Programming is carried out in 8 steps (1, 2, 3 ... 8) using sensors.

Accessing the programming level

Before you begin, ensure the following:

- The washing machine is switched on (the programme selector is pointing to a wash programme).
- The washing machine door is open.

1 Touch the *Start/Add laundry* sensor and hold it down during step 2.

2 Close the washing machine door.

Wait until the *Start/Add laundry* sensor lights up constantly ...

3 ... and then release the *Start/Add laundry* sensor.

After approx. four seconds, *P11* will light up in the time display.

Choosing and selecting programmable functions

The number of the programmable function will appear in the display as *P* and a number: e.g. *P13*.

4 Touch the > or < sensor to scroll to the next or previous programmable function:

Programmable functions	
<i>P11</i>	Buzzer duration
<i>P12</i>	Buzzer
<i>P13</i>	Keypad tone
<i>P14</i>	PIN Code
<i>P22</i>	Control panel switch-off status
<i>P24</i>	Memory
<i>P26</i>	Longer pre-wash Cottons
<i>P28</i>	Gentle action
<i>P29</i>	Reduce temperature
<i>P30</i>	Water plus
<i>P31</i>	Water plus level
<i>P32</i>	Maximum rinse level
<i>P33</i>	Suds cooling
<i>P34</i>	Anti-crease
<i>P49</i>	Low water pressure
<i>P62</i>	Backlight brightness dimmed
<i>P90</i>	Operating hours
<i>P00</i>	Factory default setting

5 Confirm the selected programmable function by touching the *Start/Add laundry* sensor.

Programmable functions

Editing and saving the programmable function

You can either switch a programmable function on or off or select different options.

- 6 Touch the > or < sensor to switch the programmable function on/off or to select an option:

Programmable function	Available options					
	-00	-01	-02	-03	-04	-05--07
P11		•	•			
P12	•	•	•			
P13	•	•	•			
P14	•	•				
P22	•	•				
P24	•	•				
P26	•	•	•	•		
P28	•	•				
P29	•	•				
P30		•	•	•		
P31		•	•	•	•	
P32	•	•				
P33	•	•				
P34	•	•				
P49	•	•				
P62		•	•	•	•	•
P00	•	•				

- 7 Confirm the chosen selection with the *Start/Add laundry* sensor.

The number of the programmable function, e.g. *P13*, will light up again.

Exiting the programming level

- 8 Turn the programme selector to .

The settings have been changed. You can alter the settings again at any time.

P11 Buzzer duration

The buzzer sounds to let you know the programme has finished. You can decide how long the buzzer should sound for.

Options

- 01 = The buzzer sounds 3 times at the end of the programme.
- 02 = The buzzer sounds until the washing machine switches off automatically (max. 1 hour).

P12 Buzzer

The buzzer sounds to let you know the programme has finished.

Options

- 00 = Buzzer is deactivated
- 01 = Buzzer is set to normal
- 02 = Buzzer is set to loud

P13 Keypad tone

Each touch of a sensor is confirmed with an audible tone.

Options

- 00 = Keypad tone is switched off
- 01 = Keypad tone is set to normal volume
- 02 = Keypad tone is set to loud volume

P14 PIN Code

The PIN code prevents the washing machine being used without your knowledge.

When the code has been activated, you have to enter a code after switching the washing machine on. Otherwise the washing machine cannot be operated.

Options

- 00 = PIN code is switched off
- 01 = PIN code is switched on

Using the washing machine with a PIN code

The code is **125** and cannot be altered.

- Switch on the washing machine.

__ _ appears in the time display and the > and < sensors light up.

- Touch the > sensor.

__ / appears in the time display.

- Confirm the number with the *Start/Stop* sensor.

The first number was saved and you can now enter the second number using the > and < sensors.

- Enter the second and third numbers and confirm the numbers with the *Start/Add laundry* sensor.

The lock is released and a wash programme can now be selected and started.

P22 Control panel standby status

To save energy the time display and sensors will go out after 10 minutes, and only the *Start/Add laundry* sensor will flash slowly.

Options

- 00 = Off
The time display and sensors will remain lit up while the washing machine is switched on
- 01 = On
The time display and sensors will switch off after 10 minutes if the programme is started.
However, the time display and sensors will remain lit up for 10 minutes after a Delay start time has elapsed, after the end of a programme, or at the end of the Anti-crease phase.

P24 Memory

The washing machine will save the last settings (temperature, spin speed and some of the Extras) selected for a programme after the programme has started.

When the programme is chosen again, the saved settings will appear in the display.

Options

- 00 = Memory is switched off
- 01 = Memory is switched on

Programmable functions

P26 Longer pre-wash Cottons

If you require a longer pre-wash you can extend the pre-wash time.

Options

- 00 = No increase in the pre-wash time
- 01 = + 6 minutes increase in the pre-wash time
- 02 = + 9 minutes increase in the pre-wash time
- 03 = + 12 minutes increase in the pre-wash time

P28 Gentle action

With gentle action activated, drum agitation is reduced. In this way, lightly soiled items can be washed more gently.

Gentle action can be activated for the *Cottons* and the *Minimum iron* programmes.

Options

- 00 = Gentle action is switched off
- 01 = Gentle action is switched on

P29 Reduce temperature

At high altitudes water has a lower boiling point. Miele recommends activating the Reduce temperature setting at altitudes of or above 2000 m to prevent water from boiling. The max. temperature is reduced to 80°C, even if a higher temperature is selected.

Options

- 00 = The Reduce temperature setting is switched off
- 01 = The Reduce temperature setting is switched on

P30 Water plus

You can determine the amount of water used if the *Water + Extra* is selected.

Options

- 01 = More water is used in the wash and rinse stages
- 02 = An extra rinse is carried out
- 03 = The water level in the wash and rinse stages is increased and an extra rinse is carried out

P31 Water plus level

There are three different water levels which can be selected by activating the *Water + Extra*.

Options

- 01 = No higher water level
- 02 = Water level increased by 1 level when washing and rinsing
- 03 = Water level increased by 2 levels when washing and rinsing
- 04 = Water level increased by 3 levels when washing and rinsing

P32 Maximum rinse level

The water level in the rinse can be permanently set to the highest value.

This function is important for allergy sufferers as it achieves excellent rinse results. The water consumption will be increased.

Options

- 00 = Maximum rinse level is switched off
- 01 = Maximum rinse level is switched on

P33 Suds cooling

When this is activated, additional water flows into the drum at the end of the main wash to cool the suds down. Hot suds can damage plastic drainage pipes.

Suds cooling takes place when a Cottons programme with a temperature of 70°C or higher is selected.

Suds cooling should be activated:

- to prevent the danger of scalding if the drain hose is hooked over the edge of a laundry tub or trough.
- where the drainage pipes are rated less than 70°C.

Options

- 00 = Suds cooling is switched off
- 01 = Suds cooling is switched on

P34 Anti-crease

The Anti-crease function helps prevent creasing if laundry is not going to be removed immediately after the end of the programme.

At the end of the programme, the drum continues to turn at intervals for up to 30 min. The door can be opened at any time during the Anti-crease phase.

Options

- 00 = The Anti-crease function is switched off
- 01 = The Anti-crease function is switched on

P49 Low water pressure

If the water pressure is below 100 kPa (1 bar), the washing machine cancels the programme and the  fault message appears.

If the water pressure cannot be increased, activating this function will prevent the programme from being cancelled.

Options

- 00 = Low water pressure is switched off
- 01 = Low water pressure is switched on

Programmable functions

P62 Backlight brightness dimmed

The brightness of the dimmed sensors in the control panel can be selected at seven different levels.

It will change as soon as a different setting is chosen.

Options

-01 = darkest level



-07 = brightest level

P90 Operating hours

You can read off how many hours the washing machine has been in operation for.

The total washing time is shown in the time display in single digits. The washing machine has been in operation for 1234 hours, for example. The figure shown in the time display will start with an *H* followed by a *1*, then a *2* and after this a *3* and a *4*. The letter *H* is displayed again after this.

P00 factory default setting

All programmable functions except *P90* operating hours are reset to the factory default settings.

Options

-00 = Go back (without reset to factory default settings)

-01 = Reset programmable functions to the factory default settings

Detergent, fabric care products, additives and machine care products are available for this washing machine. All products have been designed for Miele washing machines.

These and many other products can be ordered from shop.miele.com, Miele directly or a Miele Experience Centre.

Detergent

UltraWhite (powder detergent)

- Best results at 20/30/40/60/95°C
- Radiant white laundry thanks to powerful formula with active oxygen
- Excellent stain removal even at low temperatures

UltraColor (liquid detergent)

- Best wash results at 20/30/40/60°C
- With colour-protection formula for brilliant colours
- Excellent stain removal even at low temperatures
- Also available as a powder detergent

WoolCare delicates detergent (liquid detergent)

- For wool, silks and delicates
- Special care complex based on wheat protein and with colour-protection formula
- Best wash results at 20/30/40°C

Specialist detergents

These specialist detergents are available as convenient single-use capsules.

Caps Sport

- For synthetic fabrics
- Neutralises odours thanks to built-in odour absorber
- Prevents static charge in clothes
- Retains the shape and breathability of synthetic fabrics

Caps DownCare

- For down-filled items
- Retains the elasticity and breathability of downs
- Lanolin for effective cleaning and gentle care
- Feathers do not stick together and stay fluffy

Caps WoolCare

- Woollens and delicates detergent
- Special care complex with wheat proteins
- Fibre protection technology to prevent felting
- Colour protection formula for gentle cleaning

Detergents and care products

Fabric care

These fabric care products are available as convenient single-use capsules.

Caps Fabric Softener

- Fabric softener for freshly scented laundry
- Pure and thorough cleanliness with a fresh scent
- For cuddly soft laundry
- Prevents static charge in clothes

Additive

The additive is available as a convenient single-use capsule.

Caps Booster

- Highly effective stain remover
- Enzyme technology to help remove stubborn stains
- Suitable for whites and colours
- For excellent wash results even at low temperatures

Machine care products

Descaling agent

- Removes heavy limescale deposits
- Mild and gentle with natural citric acid
- Gentle on heater elements, drum and other components

IntenseClean

- For hygienic cleanliness in washing machines
- Removes grease, bacteria and unpleasant odours
- Effective thorough cleaning

Water softener tablets

- Reduces quantities of detergent for hard water
- Less detergent residue in textiles
- Less chemicals in waste water due to reduced amount of detergent

Miele Australia Pty. Ltd.

ACN 005 635 398

ABN 96 005 635 398

Level 4, 141 Camberwell Road
Hawthorn East, VIC 3123

1300 464 353 (1300 4 MIELE)

info@miele.com.au

www.miele.com.au

Miele New Zealand Limited

IRD 98 463 631

8 College Hill
Freemans Bay, Auckland 1011

0800 464 353 (0800 4 MIELE)

customercare@miele.co.nz

www.miele.co.nz

Miele Global Headquarters

Germany

Miele & Cie. KG

Carl-Miele-Straße 29

33332 Gütersloh

Federal Republic of Germany

WWD 320

en-AU, NZ

M.-Nr. 12 231 631 / 00