





Operating and installation instructions Washing machine



To avoid the risk of accidents or damage to the machine, it is **essential** to read these instructions before it is installed and used for the first time.

Contents

Caring for the environment	6
Warning and safety instructions	7
Operating the washing machine	15
Control panel	15
Symbols on the control panel	16
Symbols in the display	17
Sensor controls and touch display with sensor controls	18
Main menu	18
Examples of how to operate the appliance	19
Before using for the first time	20
1. Preparing the laundry	25
2. Loading the washing machine	26
3. Selecting a programme	27
4. Selecting programme settings	28
5. Adding detergent	30
Adding fabric conditioner or liquid starch separately	31
6. Starting the programme – the end of the programme	32
Delay start	33
Programme chart	34
Mop programmes	34
Cleaning cloth programmes	35
Programme packages	36
Standard programmes	42
Extras	43
Pre-wash 	43
Pre-rinse 	43
Rinse plus 	43
Microfibre 	43
Special features in the programme sequence	44
Spinning	44
Anti-crease	44

Changing the programme sequence	45
Changing a programme.....	45
Cancelling a programme	45
Switching on the washing machine after an interruption to the power supply ...	45
Adding or removing laundry	46
Cleaning and care	47
Cleaning the casing and fascia panel	47
Cleaning the detergent drawer	47
Cleaning the drum, suds container and drainage system.....	49
Cleaning the water inlet filters	49
Problem solving guide	50
The wash programme does not start	50
Programme cancellation and error message.....	51
A fault message appears in the display	52
An unsatisfactory wash result	53
General problems.....	54
The door will not open.....	55
Opening the door in the event of a blocked drain outlet and/or power cut	56
Miele Service	58
Contact in case of malfunction	58
Optional accessories.....	58
Installation	59
Front view	59
Rear view.....	60
Installation locations.....	61
Installation notes	61
Transporting the washing machine to its installation site.....	62
Installation surface	63
Removal of transit bars	63
Fitting the transit bars	65
Levelling the washing machine	66
Holding bracket for plinth	67
Positioning the holding bracket.....	67
Installing the holding bracket	68
Securing the washing machine with the holding bracket.....	68
External control equipment	69
Payment system	69
Water connection	70
Cold water connection	70
Hot water connection*	71

Contents

Drainage	71
Drain valve	71
Electrical connection	72
Technical data	74
EU Conformity declaration	75
UK Conformity declaration	75
Supervisor level	76
Code-based access	76
Changing the code	76
Accessing supervisor level	76
Exiting the Supervisor level	76
Language	77
Brightness	77
Clock display	77
Finish tone volume	77
Keypad tone volume	77
Welcome tone volume	77
Fault alarm	77
Memory	77
Anti-crease	78
Suds cooling	78
"Display" switch-off status	78
"Machine" switch-off status	79
Delay start	79
Programme name	79
Visibility parameters	79
Pre-wash water	79
Main wash water	80
First rinse water	80
Final rinse water	80
Low water pressure	80
Pre-spin mops	80
Mops temp. Standard plus	81
Mops Chemo-thermal disin.	81
Mops Th.-disin.	81
Microfibre mops	81
Mops, pre-treat rpm	81
Cloths temp Standard plus	81
Cloths Ch-th. disin.	82
Pre-treat cloths rpm	82
Empty sensor	82

Early warning counter.....	82
Water level Cottons	82
Water level Minimum iron	82
Cottons Pre-wash temp	83
Wash time Pre-wash	83
Wash time Cottons.....	83
Wash time Minimum iron.....	83
Pre-rinse Cottons	83
Pre-rinse Minimum iron	83
Pre-wash Cottons/Min. iron	83
Cottons rinses	84
Min. iron rinses	84
Disinfection rinse	84
Programme packages	84
Disinfection prog. code	85
Temp reduction.....	85
Automatic dispensing.....	85
Adjustment value dosage 1–6	85
COM module selection.....	85
Availability of Miele digital products.....	86
WiFi/LAN	86
Network time	87
External programme lock	87
Peak load signal	87
Peak load prevention.....	87
Remote	88
RemoteUpdate	88
SmartGrid	88
Controlled energy consumption	88
Alternating current	89
Heating	89
Legal information.....	89
Copyrights and licences for operator and control software.....	89
Payment system.....	90
Settings for payment systems.....	90
Feedback signal to pay system.....	90
Payment system lock	91
FOC programmes.....	91
Delete paid signal.....	91
Debounce time	91

Caring for the environment

Disposing of the packaging material

The packaging material is used for handling and protects the appliance from transport damage. The packaging material used is selected from materials which are environmentally friendly for disposal and can generally be recycled.

Recycling the packaging material reduces the use of raw materials. Use material-specific collection points for valuable materials and take advantage of return options. Your Miele dealer will take the packaging material away.

Disposing of your old appliance

Electrical and electronic appliances contain many valuable materials. They also contain certain materials, compounds and components which were essential for their correct functioning and safety. These could be hazardous to human health and to the environment if disposed of with household waste or if handled incorrectly. Please do not, therefore, dispose of your old appliance with household waste.



Instead, please make use of officially designated collection and disposal points to dispose of and recycle electrical and electronic appliances in your local community, with your dealer or with Miele, free of charge. By law, you are solely responsible for deleting any personal data from the old appliance prior to disposal. You are legally obliged to remove any old batteries which are not securely enclosed by the appliance and to remove any lamps without destroying them, where this is possible. These must be taken to a suitable collection point where they can be handed in free of charge. Please ensure that your old appliance poses no risk to children while being stored for disposal.

Warning and safety instructions

This washing machine complies with all current local and national safety requirements. However, inappropriate use can lead to personal injury and damage to property.

Read the operating instructions carefully before using the washing machine. They contain important information on safety, installation, use and maintenance. This prevents both personal injury and damage to the washing machine.

In accordance with standard IEC 60335-1, Miele expressly and strongly advises that you read and follow the instructions in the chapter on installing the washing machine as well as the safety instructions and warnings.

Miele cannot be held liable for damage caused by non-compliance with these instructions.

Keep these operating instructions in a safe place and pass them on to any future owner.

When instructing other people how to use the washing machine, they must be made aware of these safety and warning instructions.

Appropriate use

- ▶ The washing machine is only suitable for washing fabrics with a care label stating that they are suitable for machine washing. Any other applications may be dangerous. The manufacturer cannot be held liable for damage resulting from incorrect or improper use or operation of the machine.
- ▶ This washing machine must be used as described in the operating instructions and must be checked on a regular basis to make sure it is functioning correctly. Maintenance must be carried out when necessary.
- ▶ The washing machine is not suitable for outdoor use.
- ▶ This washing machine may also be operated in public areas.

Warning and safety instructions

- ▶ This washing machine can only be used by people with reduced physical, sensory or mental capabilities, or lack of experience or knowledge, if they are supervised whilst using it or have been shown how to use it in a safe way and understand and recognise the consequences of incorrect operation.
- ▶ Children under the age of 8 must not be allowed near the washing machine unless they are constantly supervised.
- ▶ Children over the age of 8 may only use the washing machine without supervision if its operation has been clearly explained to them and they are able to use it safely. Children must be able to understand and recognise the possible dangers caused by incorrect operation.
- ▶ Children may not carry out cleaning or maintenance on the washing machine unsupervised.
- ▶ Always supervise any children in the vicinity of the washing machine. Never allow children to play with the washing machine.
- ▶ Disinfection programmes must not be interrupted, as this can have a limiting effect on the disinfection result. It is the operator's responsibility to ensure that the standard of disinfection in thermal as well as chemo thermal procedures is maintained by carrying out suitable validation tests.

Technical safety

▶ Before setting up the washing machine, check it for any externally visible damage. Do not set up or use a damaged washing machine.

▶ The electrical safety of the washing machine can only be guaranteed when correctly earthed.

It is most important that this basic safety requirement is tested and in case of any doubt the on-site wiring system should be inspected by a qualified electrician.

Miele cannot be held liable for the consequences of an inadequate earthing system.

▶ Unauthorised repairs could result in unforeseen dangers for the user, for which the manufacturer cannot accept liability. Repairs should only be undertaken by a Miele approved service technician, otherwise any subsequent damage will not be covered by the warranty.

▶ Do not make any alterations to the machine, unless authorised to do so by Miele.

▶ The machine must be isolated from the electricity supply when cleaning and maintaining the machine and in the event of a fault:

- switch off at the wall and disconnect the plug from the socket, or
- disconnect the fuse at the mains circuit board, or
- unscrew the on-site screw-in fuse.

See “Installation – Electrical connection”.

Warning and safety instructions

- ▶ If the electrical connection cable is faulty it must only be replaced by a Miele authorised service technician to protect the user from danger.
- ▶ The washing machine must only be connected to the on-site water supply using a new hose kit. Old hoses must not be re-used. Check the hose regularly for signs of wear. Replace it in good time to avoid the risk of leaks and subsequent damage.
- ▶ Faulty components must only be replaced by genuine Miele original spare parts. Miele can only guarantee the safety standards of the machine when Miele replacement parts are used.
- ▶ For reasons of safety, do not connect the machine to the mains electricity supply by an extension lead, multi-socket adapter, or similar. These can overheat and are a fire hazard.
- ▶ In the case of commercial use, all relevant national provisions and regulations (DGUV in Germany) relating to accident insurance are applicable to this machine. It is recommended to carry out testing in accordance with national regulations (e.g. the regulatory framework described in DGUV100-500/Chapter 2.6/Section 4). The test book required for the documentation is available from Miele.
- ▶ The machine must not be used in a non-stationary location (e.g. on a ship).
- ▶ Please observe the instructions in “Installation” and “Technical data”.
- ▶ If the washing machine is equipped with an electrical plug connection, it must be easily accessible after installation so that the machine can be disconnected from the electricity supply if necessary.

Warning and safety instructions

- ▶ If the appliance is hard wired, an on-site all pole circuit breaker must always be accessible to disconnect the washing machine from the mains.
- ▶ Temporary or permanent operation on an autonomous power supply system or a power supply system that is not synchronised with the mains power supply (e.g. island networks, back-up systems) is possible. A prerequisite for operation is that the power supply system complies with the specifications of EN 50160 or an equivalent standard.

The function and operation of the protective measures provided in the domestic electrical installation and in this Miele product must also be maintained in isolated operation or in operation that is not synchronised with the mains power supply, or these measures must be replaced by equivalent measures in the installation. As described, for example, in the current version of BS OHSAS 18001–2 ISO 45001.

Correct use

- ▶ The maximum dry laundry weight is 8.0 kg. The maximum recommended loads for individual programmes are given in the Programme chart.
- ▶ Do not install your washing machine in a room where temperatures below freezing may occur. Frozen hoses may burst or split. The reliability of the electronic control unit may be impaired at temperatures below freezing point.
- ▶ Before using the machine for the first time, check that the transit bars at the rear of the washing machine have been removed (see “Installation – Removing transit bars”). During spinning, transit bars which are still in place may result in damage to both the machine and adjacent furniture or appliances.

Warning and safety instructions

- ▶ Close the stopcock if the machine is to be left for any length of time (e.g. while on holiday), especially if there is no floor drain (gully) in the immediate vicinity.
- ▶ Take care to ensure that foreign objects (e.g. nails, pins, coins, paper clips) do not find their way into the machine with the laundry. In particular, shake out any metal swarf which could be in the cleaning cloths before washing. These may damage components of the machine (e.g. suds container, drum). Damaged components can damage the laundry.
- ▶ If the correct amount of detergent is dispensed, the machine should not need to be descaled. If, however, you do wish to descale it, only use special non-corrosive descaling agents and strictly observe the instructions on the packaging. Special descaling agent is available from your Miele dealer or from Miele Service. Strictly observe the instructions for the descaling agent.
- ▶ For textiles that have been treated with solvent-based detergents, always check whether they can be washed in a washing machine. To check whether this is possible, refer to safety notes, information concerning the product's environmental properties, and other information.
- ▶ Never use solvent based detergents, e.g. those containing benzene, in this machine. Doing so may result in damage to component parts and create toxic fumes. Risk of fire and explosion.
- ▶ Benzene, petrol, paraffin, or any easily flammable liquid must not be stored or used near the machine. Risk of fire and explosion

Warning and safety instructions

- ▶ Only use dyes suitable for use in a washing machine. Always observe the manufacturer's instructions carefully.
- ▶ Colour run and dye removers contain sulphur compounds which can cause damage such as corrosion. Do not use these products in this washing machine.
- ▶ Avoid contact between stainless steel surfaces (front, lid, casing) and liquid detergents or disinfecting agents which contain chlorine or sodium hypochlorite. These agents can have a corrosive effect on stainless steel. Aggressive vapours containing chlorine can also be corrosive. Do not store open containers of these agents near the machine.
- ▶ Do not use a pressure washer or hose to clean the washing machine.
- ▶ It is particularly important to observe manufacturer's instructions when using a combination of cleaning agents and special application products. Products must only be used for applications approved by the manufacturer to avoid any material damage or the occurrence of strong chemical reactions.
- ▶ If detergent has come into contact with the eyes, rinse out immediately with plenty of lukewarm water. If detergent has accidentally been ingested, seek medical advice immediately. People with damaged or sensitive skin should avoid contact with detergent.
- ▶ When adding or removing laundry during the main wash, your skin may come into contact with detergent, particularly if the detergent is dispensed externally. Take care when placing your hands inside the drum. If suds have come into contact with the skin, rinse off immediately with lukewarm water.

Warning and safety instructions

Accessories



- ▶ Accessory parts may only be fitted when expressly approved by Miele. If other parts are used, warranty, performance, and product liability claims will be invalidated.
- ▶ Miele tumble dryers and Miele washing machines can be installed as a washer-dryer stack. This requires a Miele washer-dryer stacking kit which can be purchased separately. Please ensure that the washer-dryer connection kit is suitable for the Miele tumble dryer and the Miele washing machine.
- ▶ If installing the machine on a Miele plinth (available as an optional accessory), please make sure you order the correct one for this washing machine.

Miele cannot be held liable for damage caused by non-compliance with these warning and safety instructions.

Operating the washing machine

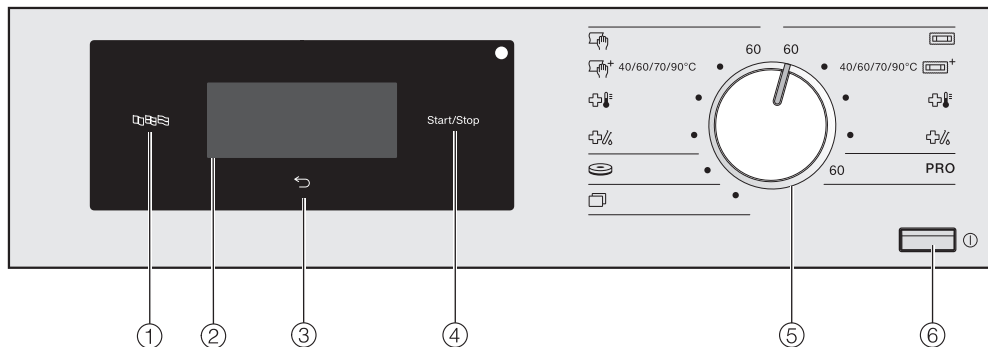
Control panel



- ① **Language sensor control** 
For selecting the current user language.
The system language is displayed again at the end of the programme.
- ② **Touch display with sensor controls**
Displays the selected programme.
The programme settings are selected using the sensor controls in the touch display.
- ③ **Back sensor control** 
For going back one level in the menu.
- ④ **Start/Stop sensor control**
Starts the selected programme and cancels a programme once it has started.
- ⑤ **Programme selector**
For selecting the wash programme.
The programme selector can be turned clockwise or anticlockwise.
- ⑥ **Button** 
For switching the washing machine on and off.
The washing machine switches itself off automatically to save energy. It is switched off 15 minutes after the end of the programme/Anti-crease phase, or after being switched on if no further selection is made.

Operating the washing machine

Symbols on the control panel

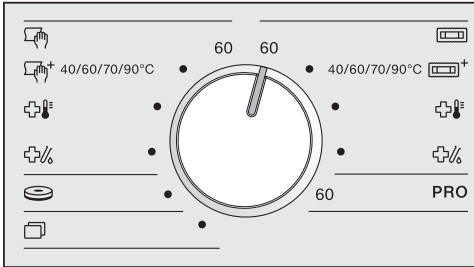

Right side:



Mops



Mops plus



Mops thermal disinfection



Mops chemo-thermal disinfection

PRO

Cottons PRO

Left side:



Cloths



Cloths plus



Cloths thermal disinfection



Cloths chemo-thermal disinfection



Pads



Further programmes

Symbols in the display



Temperature: use the *Temperature* sensor control to set the temperature of the wash programme.



Spin speed: use the *Spin speed* sensor control to set the spin speed of the wash programme.



Extras: use the *Extras* sensor control to add Extras to a wash programme.



Pre-wash: use the *Pre-wash* sensor control to select the *Pre-wash* Extra for a wash programme.



Pre-wash: use the *Pre-wash* sensor control to pre-wash the laundry before the start of the wash programme.



Rinse plus: use the *Rinse plus* sensor control to add an extra rinse cycle to a wash programme.



Microfibre: use the *Microfibre* sensor control to gently cool microfibre mops at the end of the main wash cycle.



Residual moisture: use the *Residual moisture* sensor control to set the residual moisture after spinning.



Spin duration: use the *Spin duration* sensor control to set the residual moisture after spinning.



Further choices: use the *Further choices* sensor control to set further options.



Supervisor level: use the *Supervisor level* sensor control to alter the washing machine's settings.



Delay start: use the *Delay start* sensor control to set the start time of a wash programme ...





... or the finish time



... or the time until the programme starts.

Operating the washing machine

Sensor controls and touch display with sensor controls

The sensor controls ,  and *Start/Stop* and the sensor controls in the display respond to finger tip contact. Every touch of a sensor is confirmed with an audible tone. You can adjust the volume of the keypad tone or switch it off (see information on “Supervisor level”).

The control panel with sensor controls and the touch display can be scratched by pointed or sharp objects, e.g. pens.



Only touch the display with your fingers.

Main menu

The main menu of a wash programme displays different values depending on the programme.





For programmes with a fixed temperature setting:



- Selected programme with the set temperature
- Programme duration
- Spin speed set 
- Selectable Extras 
- Further choices : Delay start and the settings on the Supervisor level

For programmes with a variable temperature setting:



- Selected programme
- Programme duration
- Temperature set 
- Spin speed set 
- Selectable Extras 
- Further choices : Delay start and the settings on the Supervisor level

Operating the washing machine

Examples of how to operate the appliance

Option lists

The \wedge and \vee arrows on the right of the display indicate that choices are available.

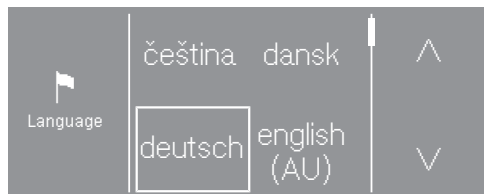

The list scrolls down when the \vee sensor is touched. The list scrolls up when the \wedge sensor is touched.

The scroll bar indicates that further options follow.

The currently selected value is marked with a frame.

Touch the required value to select it.

Easy selection

If there are no arrows, the selection is limited to the displayed values.

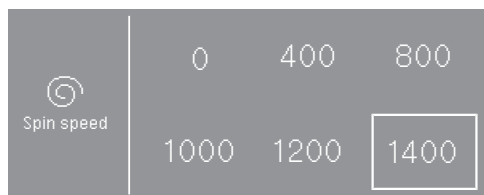

The currently selected value is marked with a frame.

Touch the required value to select it.

Setting numerical values

To change a numerical value, use the \wedge and \vee arrows above or below the numbers you want to change.



Touch the \wedge and \vee arrows and confirm with the OK sensor.

Exiting a sub-menu

Select the Back \leftarrow sensor to exit a sub-menu.

If you select a value in a sub-menu, but do not confirm with OK, you can discard this value by touching the \leftarrow sensor.

Before using for the first time

 Damage resulting from incorrect installation and connection.

Installing and connecting the washing machine incorrectly will cause serious property damage.

See “Installation”.

Emptying the drum

A swivel elbow for the drain hose and/or assembly material may be stored in the drum.

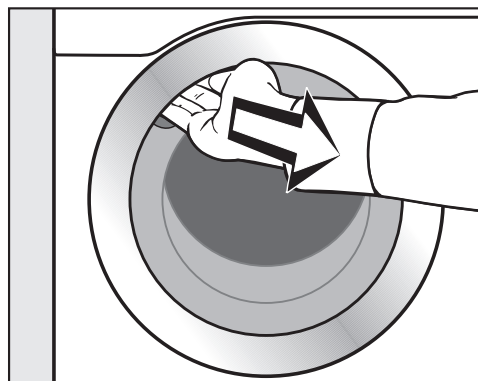

- Pull open the door.
- Remove the swivel elbow and assembly material.
- Shut the door with a gentle swing.

Switching on the washing machine

- Press the  control.

The welcome screen will light up.

When commissioning the washing machine for the first time, you will have to define settings for daily use of the appliance. Some settings can only be configured during the initial commissioning process. After that, they must be changed by Miele Service.



Complete the initial commissioning process.

These settings are also described under “Supervisor level”.

Setting the language

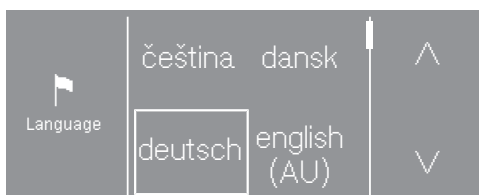
You will be asked to select the language you require for the display. You can change the language at any time (see “Language” under “Supervisor level”).



- Touch the  or  sensor until the language you want appears in the display.
- Touch the sensor for the language you want.

The selected language is marked with a frame and the display will change to next setting.

Before using for the first time

Setting the display brightness

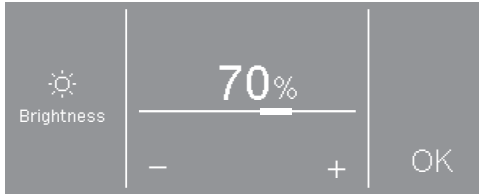

- Set the brightness you want with the – and + sensors and confirm your selection with the OK sensor.

The display will change to the next setting.

Reference to external appliances

A reference to external hardware appears.

- Confirm with the OK sensor control.

Before initial commissioning, connect the XCI box or adapter or slide a communication module into the slot on the back of the machine. The washing machine must be disconnected from the mains. Then start the commissioning process.

Confirm time request



- Touch the yes or no sensor.

If you select yes, the system will skip the Clock display setting.

If you select no, the display will switch to the Clock display setting.

Setting the time of day

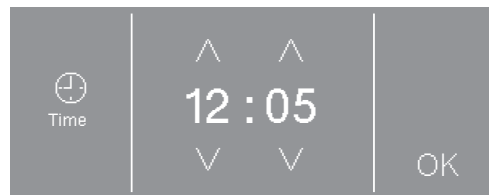

- Use the ∨ and ∧ sensors to enter the time and confirm your entry with the OK sensor.

The display will change to the next setting.

Before using for the first time

Selecting programme packages



- Touch the \wedge or \vee sensor control until the programme package you want appears in the display.
- Touch the programme package sensor control.

The display shows the associated programmes.

The activated programmes are marked with a frame.



- Touch the sensor controls for the programmes.

The programmes are activated (framed) or deactivated (no frame).

- Confirm with the *OK* sensor control.

The display switches back to the programme packages.



- Select other programme packages or confirm your selection with the *Next* sensor control.

The display will change to the next setting.

Switching on automatic dispensing

Automatic dispensing can be activated via the *XCI* box or the *COM* module.

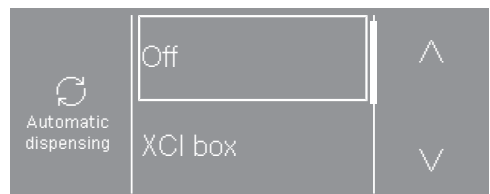

- Touch the \wedge or \vee sensor control until the option you want appears in the display.
- Touch the sensor control for the option.
- If you do not want to switch on automatic dispensing, touch the *Off* sensor control.

The display will change to the next setting.

Before using for the first time

Setting up a payment system

If you wish to set up a payment system, read “Payment system” under “Supervisor level”.

If you do not wish to set up a payment system, you can skip this stage.

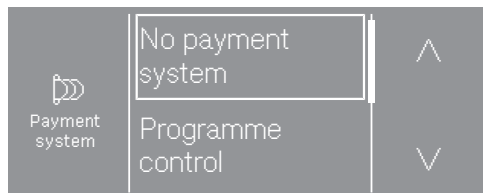

- Touch the No payment system sensor.

The display will change to the next setting.

Select pre-wash water

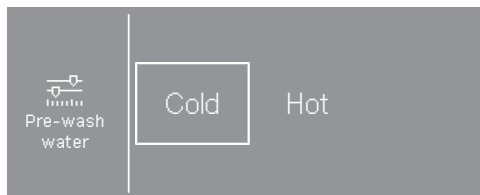

- Touch the cold sensor if the washing machine is only connected to a cold water supply, or touch hot if the washing machine is connected to cold and hot water.

The display will change to the next setting.

Select main wash water

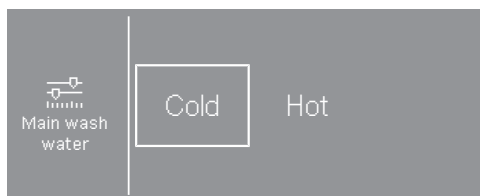

- Touch the cold sensor if the washing machine is only connected to a cold water supply, or touch hot if the washing machine is connected to cold and hot water.

Further information will appear on the display.

Before using for the first time

Removing the transit bars

The display will remind you to remove the transit bars.

 Damage resulting from failure to remove the transit bars.

Failure to remove the transit bars can result in damage to the washing machine and to adjacent furniture or appliances.

Remove the transit bars as described in “Installation and connection”.

- Confirm that the transit bars have been removed with the *OK* sensor.

Continue setting up as described in the Operating Instructions **appears in the display**.

- Confirm the message with the *OK* sensor.

Completing commissioning

To complete commissioning, the *Disinfect cloths* programme must be run without laundry and without detergent.

If the power is interrupted prior to the start of the first wash programme (e.g. if the machine is switched off with the  button), the initial commissioning process can be completed again. Once a wash programme has been running for over 20 minutes, the initial commissioning process does not have to be performed again.

- Open the stopcocks.
- Turn the programme selector to  *Disinfect cloths*.

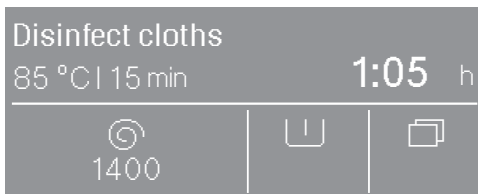

- Touch the *Start/Stop* sensor control.

When the programme has finished, your machine is ready for use.

1. Preparing the laundry



Damage due to foreign objects. Nails, coins, paper clips, and so on can cause damage to textiles and components in the machine.

Check the mops or the laundry before washing and remove any foreign objects.



Damage due to solvent-based detergents.

Cleaning agents containing benzene, stain remover, etc., can damage plastic parts.

When pre-treating textiles, make sure that plastic parts do not come into contact with the detergent.



Risk of explosion due to solvent-based detergents.

When using solvent-based detergents, an explosive mixture may develop.

Never use solvent-based detergents in the washing machine.

Sorting mops, cleaning cloths, etc.

- Separate the mops, cleaning cloths and pads.
- Shake mops, cleaning cloths and pads out well to get rid of coarse soiling before placing them in the drum.

Sorting the laundry

- Empty all pockets.
- Badly soiled areas and stains should be cleaned as soon as possible. Stains should be carefully dabbed off using a soft, colourfast cloth.
- Sort the laundry according to colour and the garment care label.

Tip: Do not wash items which are specified by the manufacturer as **not** washable on the care label ( symbol).

2. Loading the washing machine

Opening the door

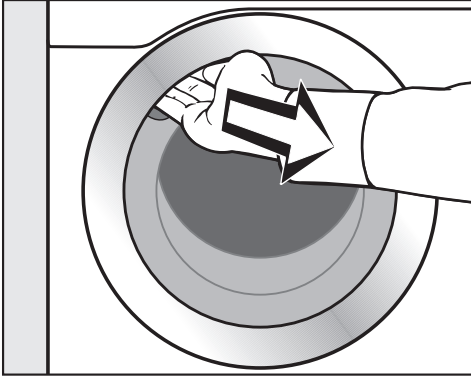

- Reach under the door grip and pull the door open.

Check the drum for foreign objects before loading it with laundry.

- Load the mops, cleaning cloths or pads loosely in the drum.
- Unfold the laundry and load loosely into the drum.

Mixing both large and small items gives better wash results and also helps to distribute the load evenly during spinning.

The most efficient use of energy and water consumption is achieved when a full load is washed. However, do not overload as this reduces cleaning efficiency and causes creasing.

Closing the door

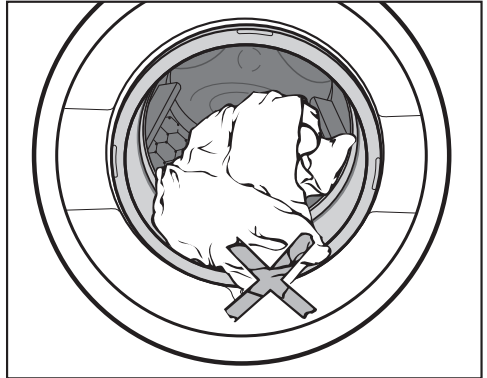

- Make sure that no items are caught between the door and the seal.

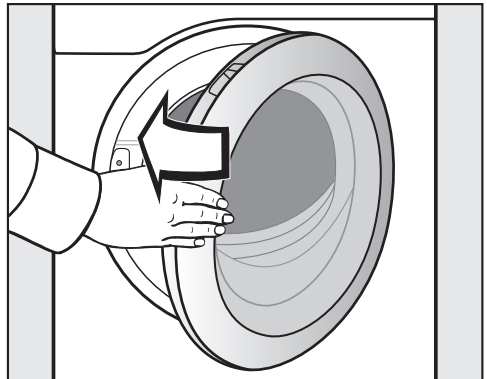

- Shut the door with a gentle swing.

3. Selecting a programme

Switching on the washing machine

- Press the  control.

Selecting a programme

Selecting standard programmes with the programme selector dial

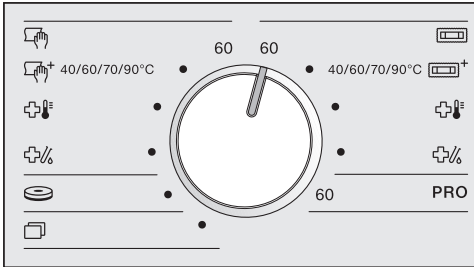

- Turn the programme selector to the required programme.

The selected programme will be shown in the display. The display will then change to the main menu for that programme.

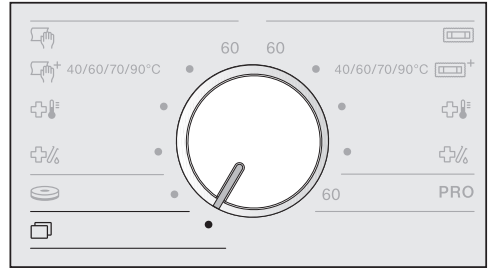

Selecting further programmes with the programme selector turned to

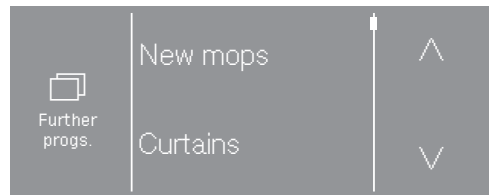

- Turn the programme selector to the  position.

You can select the required programme via the display.



- Touch the  or  sensor control until the programme you want appears in the display.
- Touch the sensor control for that programme.

The display will change to the main menu for that programme.

4. Selecting programme settings

Selecting the temperature

You can alter the preset temperature of certain programmes.

- Touch the *Temperature* 🌡️ sensor.

The following will appear in the display:



- Select the desired temperature.

The selected temperature is marked with a frame.

Selecting the spin speed

You can alter the preset spin speed.

- Touch the *Spin speed* 🌀 sensor.

The following will appear in the display:

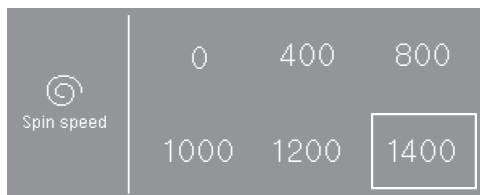

- Select the spin speed you want.

The selected spin speed is marked with a frame.

4. Selecting programme settings

Selecting extra options

You can select Extras for a wash programme.

For some programmes, an Extra is offered directly in the main menu.

- Touch the sensor of the Extra to activate it.

For some programmes, you select Extras in the *Extras* sub-menu.

- Touch the *Extras*  sensor.

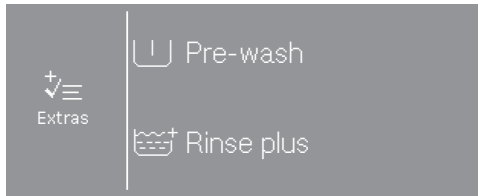

- Select one or two of the available Extras in succession.

Not all extras options can be selected with every programme. If an Extra is not listed, it is not permitted for use with the wash programme in question.

Selecting further options

You can select a delay start period or change the settings of the washing machine.

- Touch the *Further choices*  sensor control.

The following will appear in the display:



- Select the option you want.

The display will change to the sub-menu for that option.

Delay start is not possible for some programmes.

5. Adding detergent

There are several options for adding detergent to the washing machine.

Detergent drawer

You can use any detergent that is suitable for washing machines.

Detergent dispensing

Please follow the detergent manufacturer's instructions in relation to dosage.

Adding too much detergent will lead to excessive foaming.
Avoid adding excess detergent.

The amount to dispense will depend on:

- the amount of laundry
- the amount of soiling in the laundry
- the water hardness

Hardness range	Hardness in mmol/l	Degree of German hardness °dH
I (soft)	0-1.5	0-8.4
II (medium)	1.5-2.5	8.4-14
III (hard)	above 2.5	above 14

Check with your local water supplier if you do not know the water hardness in your area.

Adding detergent

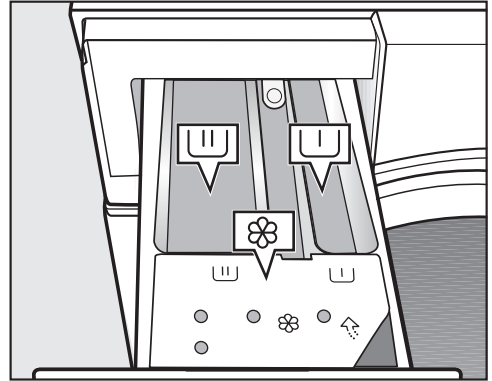

- Pull out the detergent drawer and add detergent to the compartments.

- U Detergent for the pre-wash (divide the total recommended amount as follows: $\frac{1}{3}$ to compartment U and $\frac{2}{3}$ to compartment U)
- U Detergent for the main wash
- ⊗ Fabric conditioner or liquid starch

For disinfection programmes, the U and U compartments can be filled with detergent for the main wash if you have not selected pre-wash.

5. Adding detergent

Adding fabric conditioner or liquid starch separately

- Select the *Separate rinse* programme.
- Change the spin speed if necessary.

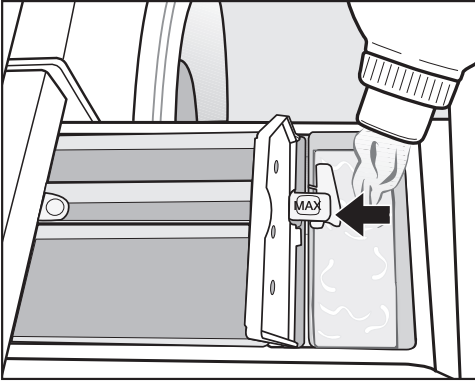

- Add fabric conditioner or liquid starch to the ☼ compartment. **Do not exceed the maximum level mark.**
- Touch the *Start/Stop* sensor.

It will be automatically dispensed in the final rinse. At the end of the wash programme a small amount of water remains in the ☼ compartment.

Dye removers and dyes

⚠ Damage due to colour run/dye removers.

Colour run and dye removers can cause corrosion in the washing machine.

Do not use colour run or dye removers in this washing machine.

Only use dyes suitable for use in a washing machine. The manufacturer's instructions on the packaging must be observed.

External dispensing

The washing machine is pre-equipped for connecting to external detergent dispensing systems. A separate conversion kit for external dispensing systems is required. This must be fitted by Miele Service or by a Miele Service dealer.

6. Starting the programme – the end of the programme

Starting the programme

The programme can be started as soon as the *Start/Stop* sensor is flashing on and off.

- Touch the *Start/Stop* sensor.

The door will lock (🔒 symbol) and the programme will start.

If a delay start period has been selected, this will appear in the display.

Once the delay start period has elapsed (if applied), the programme duration will appear in the display; otherwise, the duration will appear straight away. The programme sequence is also shown in the display.

Tip: Touch the **i** sensor to display the set temperature, spin speed and any set Extras.

End of programme

The door remains locked during the anti-crease phase. However, the washing machine door can be unlocked at any time by touching the *Start/Stop* sensor.

Unloading the drum

- Pull open the door.
- Remove the laundry.

Items left in the drum could discolour other items in the next wash or become discoloured themselves. Remove all items from the drum.

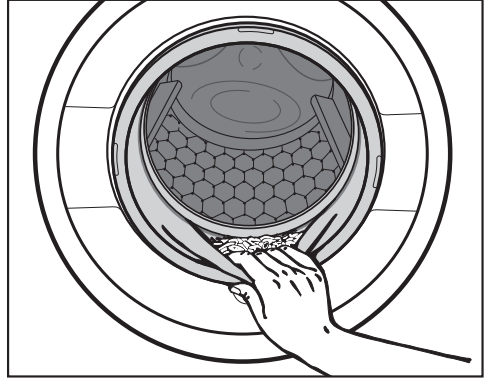

- Check the door seal for any foreign objects.





Tip: Leave the door slightly open to allow the drum to dry.

- Switch the washing machine off with the **⏻** button.

Tip: Leave the detergent drawer slightly open to allow it to dry.

The Delay start function can be used to set the time until the programme starts or the programme finish time (see “Delay start” under “Supervisor level”).

Selecting the Delay start function

- Touch the *Further choices*  sensor control.
- Select the Finish at , Start at  or Start in  option.
- Use the \wedge and \vee sensors to enter the hours and minutes and confirm your entry with the *OK* sensor.

The minutes entry moves to the next “full quarter of an hour” and can then be adjusted in 15-minute increments.

Starting Delay start

- Touch the *Start/Stop* sensor.

The door will lock and the time until the programme starts will appear in the display.

Cancelling or changing Delay start

- Touch the *Start/Stop* sensor.

The following will appear in the display:



- Touch the *Start programme immediately* sensor.

The wash programmes starts immediately.

or













- Touch the *Cancel programme* sensor.

The programme start is cancelled and the *Start/Stop* button flashes on and off.

Programme chart

Mop programmes









- A pre-spin* and a pre-rinse cycle are carried out before the main wash.

 Mops 60 °C Max. load 8.0 kg		
Items	Cotton, mixed fibre or microfibre mops	
Tip	Use specialist detergents.	
1400 rpm	Extras: 2nd Pre-rinse  , Microfibre 	Rinses: 2-5*
 Mops plus 40 °C to 90 °C Max. load 8.0 kg		
Items	Cotton, mixed fibre or microfibre mops	
Tip	<ul style="list-style-type: none"> - Use specialist detergents. - The pre-set temperature can be altered.* 	
1400 rpm	Extras: 2nd Pre-rinse  , Microfibre 	Rinses: 2-5*
 Thermal disinfection 85 °C/15 min Max. load 8.0 kg		
Items	Cotton, mixed fibre or microfibre mops	
Tip	<ul style="list-style-type: none"> - Further disinfection methods can be selected.* - Use powder detergent containing a bleaching agent. 	
1400 rpm	Extras: 2nd Pre-rinse  , Microfibre 	Rinses: 3-6*
 Chemo-therm. disinfection 60 °C/20 min Max. load 8.0 kg		
Items	Cotton, mixed fibre or microfibre mops	
Tip	<ul style="list-style-type: none"> - Further disinfection methods can be selected.* - Use specialist detergents. Observe the country-specific guidelines for disinfection. 	
1400 rpm	Extras: 2nd Pre-rinse  , Microfibre 	Rinses: 3-6*

* Settings can be altered in Supervisor level.



Cleaning cloth programmes

- A pre-rinse cycle is carried out before the main wash.

 Cloths 60 °C		Max. load 4.0 kg
Items	Cotton, mixed fibre or microfibre cloths	
Tip	Use specialist detergents.	
1400 rpm	Extras: Pre-wash 	Rinses: 2-5*
 Cloths plus 40 °C to 90 °C		Max. load 4.0 kg
Items	Cotton, mixed fibre or microfibre cloths	
Tip	<ul style="list-style-type: none"> - Use specialist detergents. - The pre-set temperature can be altered.* 	
1400 rpm	Extras: Pre-wash 	Rinses: 2-5*
 Thermal disinfection 85 °C/15 min		Max. load 4.0 kg
Items	Cotton, mixed fibre or microfibre cloths	
Tip	Use specialist detergents.	
1400 rpm	Extras: Pre-wash 	Rinses: 3-6*
 Chemo-therm. disinfection 70 °C/10 min		Max. load 4.0 kg
Items	Cotton, mixed fibre or microfibre cloths	
Tip	<ul style="list-style-type: none"> - Further disinfection methods can be selected.* - Use specialist detergents. Observe the country-specific guidelines for disinfection. 	
1400 rpm	Extras: Pre-wash 	Rinses: 3-6*

* Settings can be altered in Supervisor level.

Programme chart

Cottons PRO 60 °C		Max. load 8.0 kg
Items	Mixed fibre textiles (50 % cotton and 50 % polyester)	
Tip	- Extra energy-efficient wash programme for commercial cotton or cotton/synthetic blend textiles with normal levels of soiling, e.g. workwear.	
1400 rpm	Extras: Pre-wash 	Rinses: 2
 Pads 40 °C		Max. load 1.5 kg
Items	Microfibre polishing pads and buffers	
Tip	- A pre-rinse cycle is carried out before the main wash. - Use specialist detergents.	
1400 rpm	Extras: 2nd Pre-rinse 	Rinses: 3



Programme packages

You can select various programmes packages. The programmes selected from the programme packages are displayed under the *Further programmes* list.

Standard

New mops 60 °C to 90 °C		Max. load 8.0 kg
Items	Cotton, mixed fibre or microfibre mops	
Tip	- For washing new mops before first use. Manufacturing residues are washed out of the fibres. This increases the amount of water absorbed by the fibres when mopping. - Use universal or colour detergents. - Do not use fabric conditioner.	
1400 rpm	Extras: Microfibre 	Rinses: 2











Programme chart

Curtains cold to 40 °C		Max. load 3.0 kg
Items	Curtains specified as machine-washable by the manufacturer	
Tip	<ul style="list-style-type: none"> - A pre-rinse cycle is carried out before the main wash. - For curtains which crease easily, deselect the spin speed function. 	
600 rpm	Extras: Pre-wash 	Rinses: 3
Separate rinse		Max. load 8.0 kg
Items	Items which only need to be rinsed and spun	
Tip	<ul style="list-style-type: none"> - For rinsing residual detergent. - For removing coarse soiling before the main wash. - Make sure you select the appropriate spin speed. 	
1400 rpm		Rinses: 2
Drain/Spin		Max. load 8.0 kg
Tip	Make sure you select the appropriate spin speed.	
1400 rpm		
Clean machine 70 °C		No load
	<p>For cleaning the suds container and the drainage system.</p> <ul style="list-style-type: none"> - Add universal detergent to the  compartment. - Use the <i>Clean machine</i> programme regularly if you frequently use disinfection programmes. 	

Programme chart

Pre-treat mops (ready to use)







- Mops are washed and pre-treated in one cycle.
- A pre-spin* and a pre-wash cycle are carried out before the main wash.
- There is no water intake via the fabric conditioner compartment during the disinfecting process.

Mops +rtu 60 °C		Max. load 8.0 kg
Items	Cotton, mixed fibre or microfibre mops	
Tip	Add the pre-treating agent via the fabric conditioner compartment or the external dispensing system.	
0-60 sec	Extras: 2nd Pre-rinse  , Microfibre 	Rinses: 2-5*
Mops plus + rtu 40 °C to 90 °C		Max. load 8.0 kg
Items	Cotton, mixed fibre or microfibre mops	
Tip	Add the pre-treating agent via the fabric conditioner compartment or the external dispensing system.	
0-60 sec	Extras: 2nd Pre-rinse  , Microfibre 	Rinses: 2-5*
 Mops disinfection + rtu 85 °C		Max. load 8.0 kg
Items	Cotton, mixed fibre or microfibre mops	
Tip	<ul style="list-style-type: none"> - Further disinfection methods can be selected.* - Use powder detergent containing a bleaching agent. 	
0-60 sec	Extras: 2nd Pre-rinse  , Microfibre 	Rinses: 3-6*
 Mops disinfection + rtu 70 °C		Max. load 8.0 kg
Items	Cotton, mixed fibre or microfibre mops	
Tip	<ul style="list-style-type: none"> - Further disinfection methods can be selected.* - Use specialist detergents. Observe the country-specific guidelines for disinfection. 	
0-60 sec	Extras: 2nd Pre-rinse  , Microfibre 	Rinses: 3-6*
Mops rtu		Max. load 8.0 kg
Items	Cotton, mixed fibre or microfibre mops	
Tip	<ul style="list-style-type: none"> - For pre-treating clean mops. - Add the pre-treating agent via the fabric conditioner compartment or the external dispensing system. 	
0-60 sec		Rinses: 1

* Settings can be altered in Supervisor level.

Pre-treat cloths (ready to use)

- Cleaning cloths are washed and pre-treated in one cycle.
- A pre-wash cycle is carried out before the main wash.
- There is no water intake via the fabric conditioner compartment during the disinfecting process.



Cloths + rtu 60 °C		Max. load 4.0 kg
Items	Cotton, mixed fibre or microfibre cloths	
Tip	Add the pre-treating agent via the fabric conditioner compartment or the external dispensing system.	
0-60 sec	Extras: Pre-wash 	Rinses: 2-5*
Cleaning plus + rtu 40 °C to 90 °C		Max. load 4.0 kg
Items	Cotton, mixed fibre or microfibre cloths	
Tip	Add the pre-treating agent via the fabric conditioner compartment or the external dispensing system.	
0-60 sec	Extras: Pre-wash 	Rinses: 2-5*
 Disinfect cloths+ rtu 85 °C		Max. load 4.0 kg
Items	Cotton, mixed fibre or microfibre cloths	
Tip	<ul style="list-style-type: none"> - Further disinfection methods can be selected.* - Use specialist detergents. 	
0-60 sec	Extras: Pre-wash 	Rinses: 3-6*
 Disinfect cloths+ rtu 70 °C		Max. load 4.0 kg
Items	Cotton, mixed fibre and microfibre cleaning cloths	
Tip	<ul style="list-style-type: none"> - Further disinfection methods can be selected.* - Use specialist detergents. Observe the country-specific guidelines for disinfection. 	
0-60 sec	Extras: Pre-wash 	Rinses: 3-6*
Cloths rtu		Max. load 4.0 kg
Items	Cotton, mixed fibre or microfibre cloths	
Tip	<ul style="list-style-type: none"> - For pre-treating clean cleaning cloths. - Add the pre-treating agent via the fabric conditioner compartment or the external dispensing system. 	
0-60 sec	Extras: Pre-wash 	Rinses: 1

* Settings can be altered in Supervisor level.

Programme chart

Ready to use





- The residual moisture after pre-treatment is selected with the $\delta\text{--}\delta$ sensor control.

Mops + rtu $\delta\text{--}\delta$ 40 °C to 90 °C		Max. load 8.0 kg
Items	Cotton, mixed fibre or microfibre mops	
Tip	<ul style="list-style-type: none"> - Mops are washed and finished in one cycle. - A pre-spin* and a pre-rinse cycle are carried out before the main wash. - Add the pre-treating agent via the fabric conditioner compartment or the external dispensing system. 	
$\delta\text{--}\delta\delta\delta\delta$	Extras: Pre-rinse  , Microfibre 	Rinses: 2–5*
Mops rtu $\delta\text{--}\delta$ cold		Max. load 8.0 kg
Items	Cotton, mixed fibre or microfibre mops	
Tip	<ul style="list-style-type: none"> - For finishing clean mops. - Add the pre-treating agent via the fabric conditioner compartment or the external dispensing system. 	
$\delta\text{--}\delta\delta\delta\delta$		Rinses: 1

* Settings can be altered in Supervisor level.







Programme chart

Workwear

Oil/fat special 60 °C to 90 °C		Max. load 8.0 kg
Items	Work coats, jackets, hats, cleaning cloths made from cotton or mixed fibres	
Tip	<ul style="list-style-type: none"> - Activate Pre-wash for heavy contamination. - Use liquid detergent. 	
1400 rpm	Extras: Pre-wash 	Rinses: 3
Dust/Flour special 40 °C to 90 °C		Max. load 8.0 kg
Items	Cotton or mixed fibre workwear, table cloths or cleaning cloths soiled with dust or flour	
Tip	<ul style="list-style-type: none"> - The automatic pre-rinse removes any coarse soiling. Add a second pre-rinse for very heavy levels of soiling. - Select Pre-wash for stubborn stains. 	
1400 rpm	Extras: Pre-wash  , Pre-rinse 	Rinses: 3
Intensive wash 60 °C to 90 °C		Max. load 8.0 kg
Items	Heavily soiled workwear made from cotton, linen and mixed fibres	
Tip	You can achieve particularly good wash and rinse results with a high water level.	
1400 rpm	Extras: Pre-wash 	Rinses: 2

Programme chart

Standard programmes

Whites 90 °C		Max. load 8.0 kg
Use for	Cotton, linen and mixed fibre textiles	
Tip	An additional pre-wash can be programmed.*	
1400 rpm	Extras: Pre-wash 	Rinse cycles: 1–5*
Coloured items 30 °C to 60 °C		Max. load 8.0 kg
Use for	Cotton, linen and mixed fibre textiles	
Tip	<ul style="list-style-type: none"> - For dark-coloured fabric, use a colour detergent or liquid detergent. - An additional pre-wash can be programmed.* 	
1400 rpm	Extras: Pre-wash 	Rinse cycles: 1–5*
Minimum iron 30 °C to 60 °C		Max. load 4.0 kg
Items	Synthetic and mixed fibre textiles and easy care cotton	
Tip	<ul style="list-style-type: none"> - Reduce the spin speed for fabric that creases easily. - An additional pre-rinse can be programmed in.* 	
1200 rpm	Extras: Pre-wash 	Rinses: 2–4*
Express 20 °C to 60 °C		Max. load 4.0 kg
Items	Cotton garments that have hardly been worn or are only very lightly soiled	
1400 rpm	Extras: Rinse plus 	Rinses: 1
Lightweight curtains cold to 40 °C		Max. load 3.0 kg
Items	Curtains specified as machine-washable by the manufacturer	
Tip	For curtains which crease easily, deselect the spin speed function.	
600 rpm	Extras: Pre-wash  , Rinse plus 	Rinses: 2

* Settings can be altered in Supervisor level.

You can add Extras to the wash programmes.

Not all Extras can be selected with every programme. If an Extra is not listed, it is not permitted for use with the wash programme in question.

Selecting Extras

For some programmes, an Extra is offered directly in the main menu.

- Touch the sensor of the Extra to activate it.

For some programmes, you select Extras in the *Extras* sub-menu.

- Touch the *Extras*  sensor.
- Select one or two of the Extras available.

Pre-wash

A Pre-wash can be added for heavily soiled laundry. Coarse soiling is loosened and removed before the main wash.

Pre-rinse

The laundry is rinsed before the main wash to remove larger quantities of soiling, e.g. dust, sand.

Rinse plus

An extra rinse can be activated to achieve a better wash result.

Microfibre

Microfibre mops are gently cooled at the end of the main wash cycle.

Special features in the programme sequence

Spinning

Final spin speed

When a programme is selected, the maximum spin speed for this wash programme is shown in the display.

You can reduce the final spin speed.

However, you cannot select a final spin speed higher than that shown in the chart.

Interim spin



There is a spin cycle after the main wash and between the rinses. A reduction in the final spin speed will also reduce the interim spin speed as appropriate.

Omitting the interim spin and the final spin

- Select the programme setting *Spin speed 0*.

After the last rinse, the water will be pumped away and the anti-crease phase will switch on.

Spinning for mop and cleaning cloth programmes

In pre-treat programmes for mops and cleaning cloths, the residual moisture of the load can be set using either the *Spin duration*  or the *Residual moisture*  sensor control. The stored spin speeds can be altered (see “Supervisor level”).

Anti-crease

At the end of the programme, the drum continues to turn at intervals for up to 30 minutes to help prevent creasing. The washing machine can be opened at any time.

There is no anti-crease phase at the end of some programmes.

Changing the programme sequence

Changing a programme

After the start of a programme, it is no longer possible to select a different programme.

You will need to cancel the current programme before you can select a new one.

Programme cannot be changed appears in the display if the programme selector has been moved. The text disappears when the programme selector is set to the original programme.

Cancelling a programme

You can cancel a wash programme at any time after it has started.

Disinfection programmes can only be cancelled with a PIN code.

- Touch the *Start/Stop* sensor.
- Select *Cancel programme*.

The suds will be pumped away. The programme is cancelled. The door lock is released.

- Pull open the door.
- Remove the laundry.

If you want to select a different programme:

- Close the door.
- Select the programme you want.
- Add detergent to the detergent dispenser drawer, if necessary.
- Touch the *Start/Stop* sensor.

The new programme will begin.

Switching on the washing machine after an interruption to the power supply

If the washing machine is switched off with the ① button during a wash programme, the programme will be interrupted.

- Switch the washing machine back on with the ① button.
- Note the message in the display.
- Touch the *Start/Stop* sensor.

The programme will also be interrupted if power is interrupted by a power cut.

- When power is resumed, confirm the message in the display with *OK*.
- Touch the *Start/Stop* sensor.

The programme continues.

Changing the programme sequence

Adding or removing laundry

You can add or remove items during the first few minutes after the programme has started.

- Touch the *Start/Stop* sensor.

The following will appear in the display:



- Touch the *Add laundry* sensor.

The programme will stop and the door will unlock.

 Risk of chemical burns from detergent.

When adding or removing laundry, your skin may come into contact with detergent, particularly if the detergent is dispensed externally.

Take care when placing your hands inside the drum.

If suds have come into contact with the skin, rinse off immediately with plenty of lukewarm water.

- Pull open the door.
- Add laundry or remove individual items.
- Close the door.
- Touch the *Start/Stop* sensor.

The programme will continue.

Once a programme has started successfully, the washing machine cannot recognise any adjustment to the load.

For this reason, if laundry is added or removed after the start of a programme, the machine will always complete the programme cycle assuming a full load.

The door cannot be opened, if:

- The suds temperature is above 55 °C.

The safety lock will remain activated if the temperature in the drum is above 55 °C. The lock will not deactivate until the temperature has dropped to below 55 °C.

⚠ Risk of electric shock.

Only ever perform cleaning and maintenance work when the appliance is disconnected from the power.

Disconnect the washing machine from the mains electricity supply.

Cleaning the casing and fascia panel

⚠ Damage caused by detergents.

Solvent-based cleaning agents, abrasive cleaners, glass cleaners or multi-purpose cleaning agents can cause damage to plastic surfaces and other parts.

Do not use any of these cleaning agents.

⚠ Risk of damage due to ingress of water.

The pressure of a water jet can cause water to get into the washing machine, resulting in damage to components.

Do not spray the washing machine with a water jet.

- Clean the casing and fascia panel with a mild cleaning agent or soap and water and dry both with a soft cloth.
- The drum and any other stainless steel components can be cleaned using a suitable stainless-steel cleaning agent.

Cleaning the detergent drawer

Washing at low temperatures and the use of liquid detergent can lead to a build-up of mould and bacteria in the detergent drawer.

- For hygiene reasons, clean the entire detergent drawer at regular intervals.

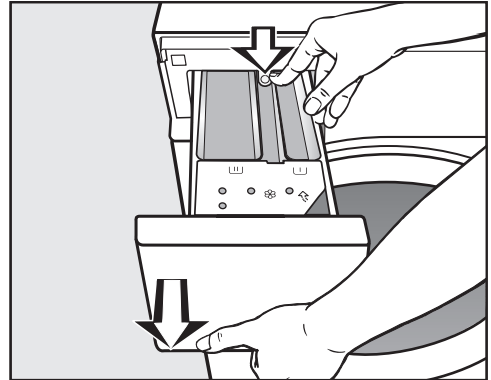

- Pull out the detergent drawer until resistance is felt. Press down the release button and at the same time pull the drawer right out of the machine.
- Clean the detergent drawer with warm water.

Cleaning and care

Cleaning the siphon and the channel

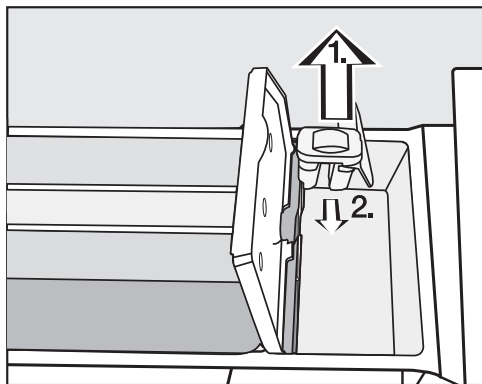

- Pull the siphon out of the compartment .
Clean the siphon under warm running water.
- Refit the siphon.
- Clean the fabric conditioner channel using a brush and warm water.

Cleaning the detergent dispenser drawer compartment

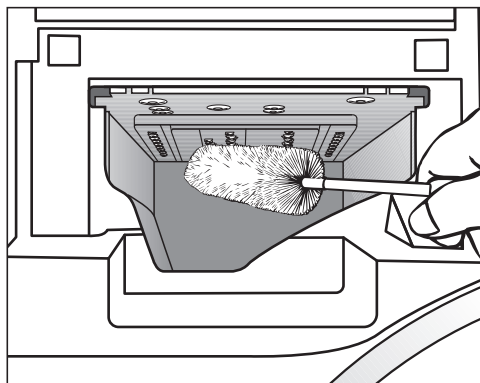

- Use a bottle brush to remove detergent residues and limescale from the jets inside the detergent drawer.
- Replace the detergent drawer.

Tip: Leave the detergent drawer slightly open to allow it to dry.

Cleaning the drum, suds container and drainage system

The drum, suds container, and drainage system can be cleaned if necessary.

- Start the *Clean machine* programme.
- Add powder detergent to the  compartment in the detergent drawer.
- At the end of the programme, check the inner drum and remove any coarse residues.

Use the *Clean machine* programme regularly if you frequently use disinfection programmes.

Cleaning the water inlet filters

The washing machine has filters to protect the water intake valves. Check these filters every 6 months or so. Perform this check more often if there are frequent interruptions to the external water supply.

Cleaning the filters in the water inlet valves

- Using pliers, carefully loosen the nut on the intake valve and unscrew.

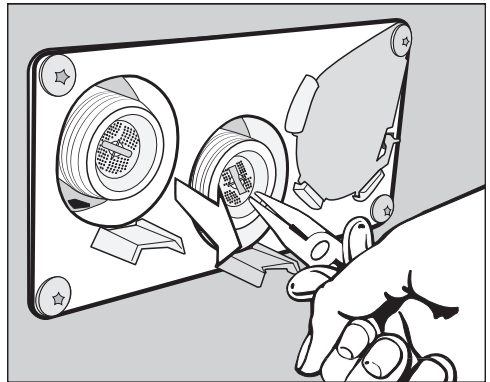

- Use pointed pliers to grip the bar and pull out the filter; then clean the filter. Reassemble in reverse order.

The filters must be put back in place after cleaning.

Problem solving guide





You are able to correct the majority of faults and problems that arise during day-to-day use without external assistance. You can save time and money in many cases, as you do not need to call Miele Service.

The following tables are designed to help you to find the cause of a malfunction or a fault and to resolve it.

The wash programme does not start

Problem	Cause and remedy
The display remains dark, and the <i>Start/Stop</i> sensor control does not light up or flash.	There is no power to the machine. <ul style="list-style-type: none">■ Check whether the washing machine is switched on.■ Check whether the washing machine is connected to the power supply.■ Check whether the main fuse or circuit breaker has tripped.
	The washing machine has switched off automatically to save energy. <ul style="list-style-type: none">■ Switch the washing machine back on with the ⓘ button.
The following appears in the display: ⓘ Door will not lock. Call Service.	The door is not closed properly. The door lock could not engage. <ul style="list-style-type: none">■ Close the door again.■ Start the programme again. If the fault message appears again, contact Miele Service.
The programme does not start when <i>Spin</i> has been selected.	You have not yet completed the initial commissioning process. <ul style="list-style-type: none">■ Perform the <i>Initial commissioning process</i> as described in these instructions.
The display is dark and the <i>Start/Stop</i> sensor control is flashing slowly.	The display has switched off automatically to save energy. <ul style="list-style-type: none">■ Touch any of the controls. The display switches back on.

Programme cancellation and error message

Problem	Cause and remedy
 Water drainage fault.	The drain is blocked or restricted. ■ Call Miele Service.
 Water intake fault. Open stopcock.	The water inlet is blocked or restricted. ■ Check whether the stopcock has been properly opened. ■ Check whether the inlet hose is kinked.
	The water pressure is too low. ■ Switch on the Low water pressure setting (see “Low water pressure” under “Supervisor level”).
	The filters in the water inlet are blocked. ■ Clean the filters (see “Cleaning the filters” under “Cleaning and care”).
 Waterproof system activated	The water protection system has reacted. ■ Close the stopcock. ■ Call Miele Service.
 Disinfection temperature not reached	The required temperature was not reached during the disinfection programme. ■ The washing machine has not carried out the disinfection cycle correctly. ■ Start the programme again.
 Fault F . If restart fails, call Service	There is a fault. ■ Disconnect the washing machine from the electricity supply. ■ Wait at least 2 minutes before reconnecting the washing machine to the electricity supply. ■ Switch the washing machine on again. ■ Start the programme again. If the fault message appears again, contact Miele Service.

Problem solving guide

A fault message appears in the display¹⁾

Problem	Cause and remedy
i Container empty	One of the external detergent containers is empty. ■ Refill the detergent container.
i Container 1 empty	External detergent container 1 is almost empty. The message can refer to containers 1 to 6. ■ Refill the detergent container. ■ Reset the container's early-warning counter (see "Early-warning counter" under "Supervisor level")
i Check hot water inlet	The hot water supply is blocked or restricted. ■ Check whether the hot water stopcock has been properly opened. ■ Check whether the inlet hose is kinked.
i Align machine. Laundry not properly spun	The selected spin speed was not reached during the final spin due to excessive imbalance. ■ Check that the washing machine is level. ■ Start the spin cycle again.
i Machine is leaking	The washing machine or drain valve is leaking. ■ Close the stopcock. ■ Call Miele Service.



¹ The messages will appear at the end of the programme and when the washing machine is switched on and must be acknowledged with the *OK* sensor control.

An unsatisfactory wash result



Problem	Cause and remedy
<p>Liquid detergent does not give the required result.</p>	<p>Liquid detergents usually contain no bleaching agents. They do not remove fruit, coffee, and tea stains.</p> <ul style="list-style-type: none"> ■ Use a general purpose powder detergent containing a bleaching agent. ■ Pour stain removers into the  drawer in the dispenser compartment and liquid detergent into a dispenser ball. ■ Never put stain removers and liquid detergent together in the dispenser drawer.
<p>White residues which look like powder detergent are seen on dark textiles after washing.</p>	<p>The detergent contained compounds (zeolites) to aid water softening which are not soluble in water. These have ended up on the laundry.</p> <ul style="list-style-type: none"> ■ Try to brush off the residues with a soft brush once the laundry is dry. ■ In future, wash dark textiles using a detergent which contains no zeolites. Liquid detergents usually contain no zeolites.
<p>Textiles with particularly greasy soiling are not properly clean.</p>	<ul style="list-style-type: none"> ■ Select a programme with pre-wash. Use liquid detergent for the pre-wash. ■ Continue to use universal powder detergent for the main wash. <p>The use of heavy-duty detergent is recommended in the main wash for very heavily soiled work clothing. Please seek advice from the detergent manufacturer.</p>
<p>Grey, greasy particles cling to washed laundry.</p>	<p>Insufficient amounts of detergent were used. The laundry was heavily soiled with grease (oils, ointments).</p> <ul style="list-style-type: none"> ■ Use more detergent or use liquid detergent with this type of soiled laundry. ■ Before washing the next load, run a 60 °C programme with liquid detergent but without a load.

Problem solving guide

General problems

Problem	Cause and remedy
The machine shakes during the spin cycle.	The machine feet are not level and not secured. <ul style="list-style-type: none"> ■ Level the machine and adjust the feet correctly.
Large amounts of detergent residue remain in the detergent dispenser drawer.	The water pressure is too low. <ul style="list-style-type: none"> ■ Clean the filters in the water inlet.
	Powder detergent used in conjunction with water softeners tends to become sticky. <ul style="list-style-type: none"> ■ Clean the detergent dispenser drawer and, in future, add detergent into the drawer first, and then add the water softener.
Fabric softener is not completely dispensed or too much water remains in the  compartment.	The siphon tube is not correctly positioned or is clogged. <ul style="list-style-type: none"> ■ Clean the siphon, see “Cleaning and care – Cleaning the detergent dispenser compartment”.
The display is in a different language.	A different language has been selected. <ul style="list-style-type: none"> ■ Switch the washing machine off and on again. <p>The selected operator language appears in the display.</p>
	The operator language has been changed. <ul style="list-style-type: none"> ■ Select the language you require (see “Language” under “Supervisor level”).
The laundry has not been spun properly. The laundry is still wet.	The machine detected a high level of imbalance during the final spin and reduced the spin speed automatically. <ul style="list-style-type: none"> ■ Include both large and small items in the load as this will achieve better distribution.
The drum remains stationary but the programme keeps running.	<ul style="list-style-type: none"> ■ Switch the washing machine off and then back on with the  button. ■ Note the message in the display. ■ Touch the <i>Start/Stop</i> sensor control. <p>The drum continues to spin and the programme continues.</p>

The door will not open

Problem	Cause and remedy
<p>The door cannot be pulled open during a wash programme.</p>	<p>The door is locked during the wash programme.</p> <ul style="list-style-type: none"> ■ Touch the <i>Start/Stop</i> sensor control. ■ Select <i>Cancel programme</i> or <i>Add laundry</i>. <p>The door will unlock and you will be able to pull it open.</p> <hr/> <p>The water level in the drum is too high.</p> <ul style="list-style-type: none"> ■ Cancel the programme. The washing machine will pump away the water.
<p> Programme cancelled appears in the display at the end of a programme or after a programme has been cancelled.</p>	<p>To protect the user against scalding, the door cannot be opened if the suds temperature is higher than 55 °C.</p> <ul style="list-style-type: none"> ■ Wait until the temperature in the drum has decreased and the message has gone out in the display.
<p>The following appears in the display:  Door lock jammed. Call Service.</p>	<p>The door lock has jammed.</p> <ul style="list-style-type: none"> ■ Call Miele Service.

Problem solving guide

Opening the door in the event of a blocked drain outlet and/or power cut

 Risk of electric shock.
Only ever perform cleaning and maintenance work when the appliance is disconnected from the power.
Disconnect the washing machine from the mains electricity supply.

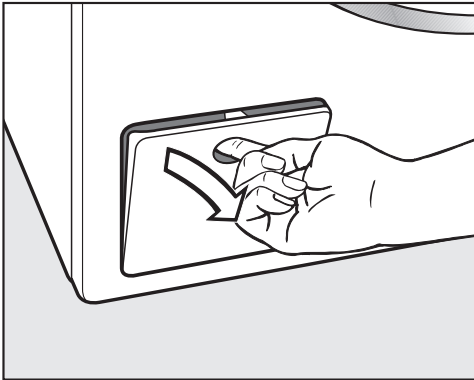

- Open the access panel to the drain system.

Blocked drain outlet

If the drain outlet is blocked, there may be a large quantity of water (max. 30 l) left behind in the washing machine.

 Risk of scalding due to hot suds.
Escaping suds will be hot if laundry has been washed at high temperatures.
Carefully allow all suds to drain off.

Emptying the drum

...In machines with a drain valve

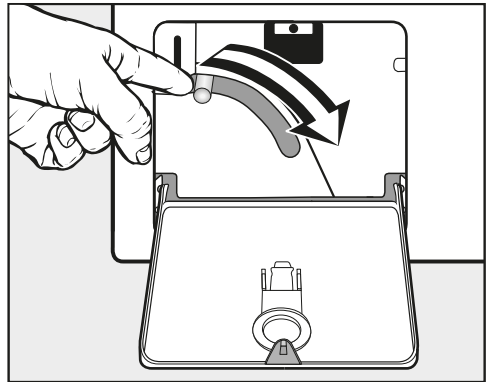

- Push the emergency drain lever downwards and hold until no more water runs out.

Opening the door

⚠ Danger of injury due to rotating drum.

Reaching into a moving drum is extremely dangerous.

Always make sure that the drum is stationary before reaching in to remove laundry.

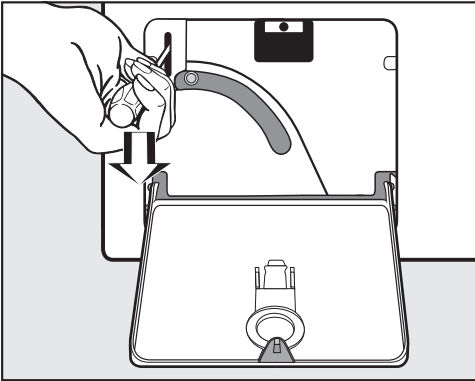

- Use a screwdriver to unlock the door.
- Pull open the door.

Miele Service

Contact in case of malfunction

In the event of any faults which you cannot remedy yourself, please contact your Miele Dealer or Miele Service.

Contact information for Miele Service can be found at the end of this document.

Please quote the model and serial number of your appliance when contacting Miele Service. This information can be found on the data plate.

The data plate is found above the porthole glass when the washing machine door is opened:

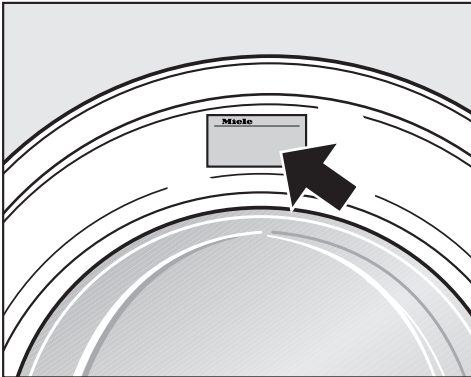

Optional accessories

Optional spare parts and accessories for this washing machine are available from Miele.

Front view

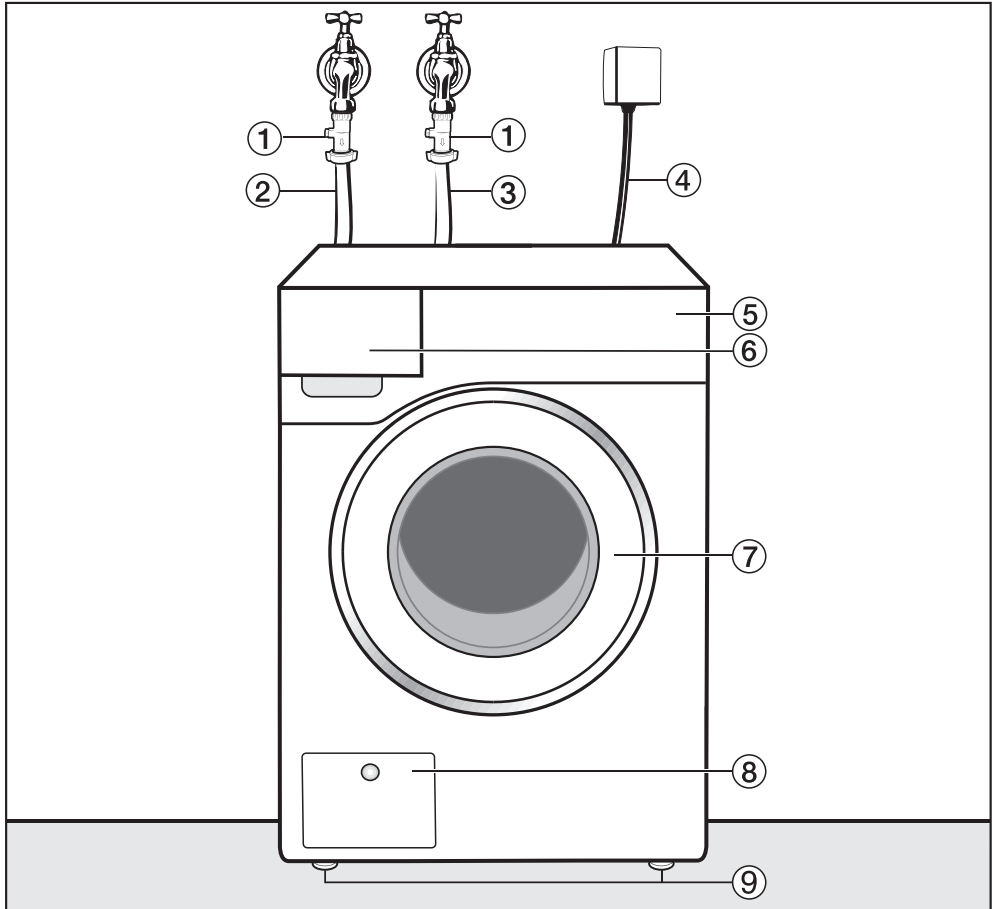

- ① Double check valves (for UK only)
- ② Inlet hose (cold water)
- ③ Inlet hose (hot water)
- ④ Electrical connection
- ⑤ Control panel
- ⑥ Detergent drawer
- ⑦ Door
- ⑧ Access to drain valve and emergency release
- ⑨ Height-adjustable feet

Installation

Rear view

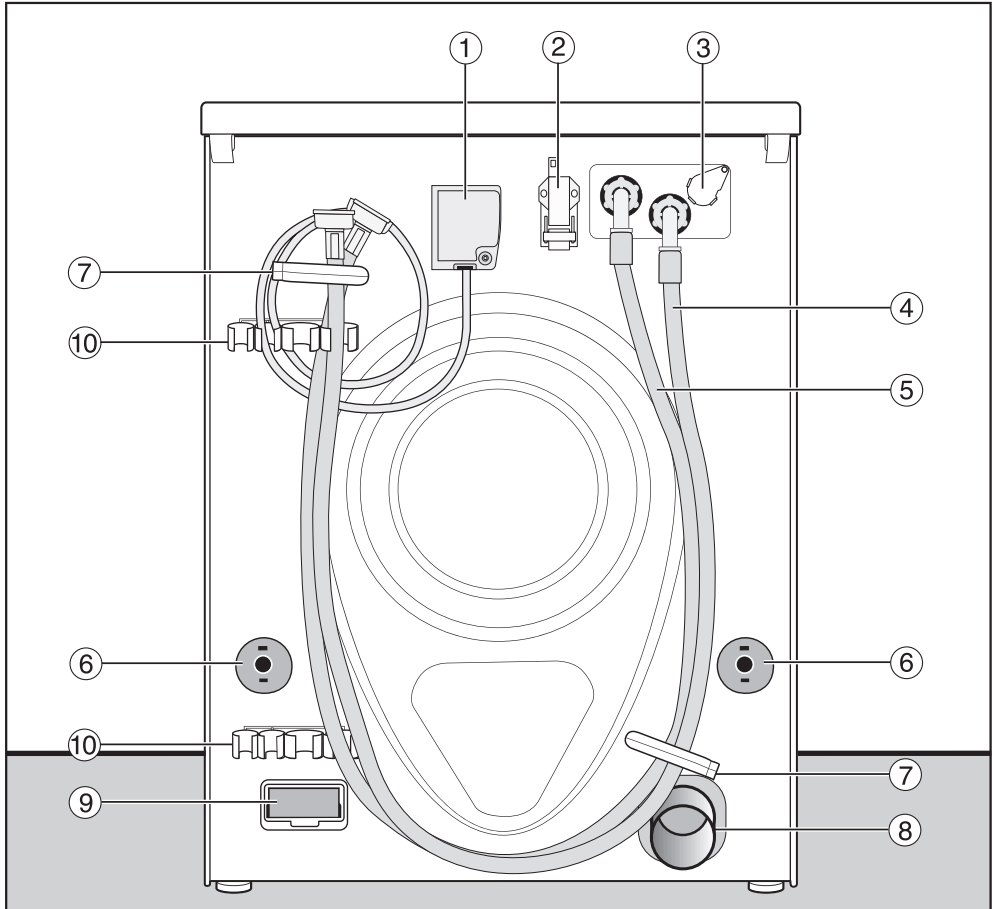

- ① Electrical connection
- ② Interface for communicating with external appliances
- ③ Socket for external dispensing system
- ④ Inlet hose (cold water)
- ⑤ Inlet hose (hot water), if fitted
- ⑥ Safety caps for transit bars
- ⑦ Transport clips for hoses
- ⑧ Drain pipe
- ⑨ Module slot (for external communication module)
- ⑩ Holder for removed transit bars

Installation locations

Side view

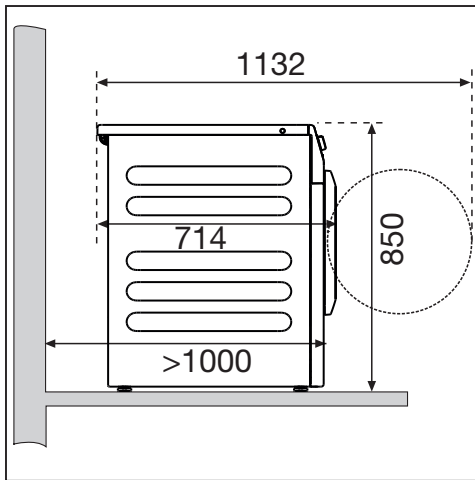

Washer-dryer stack

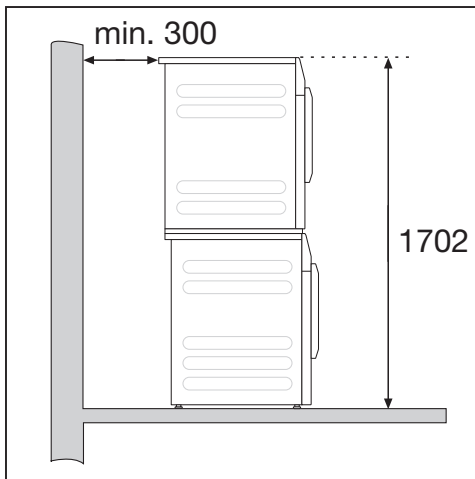

The washing machine can be installed as a washer-dryer stack together with a Miele tumble dryer. This requires a Miele washer-dryer stacking kit which can be purchased separately.

Installation on a plinth

The washing machine can be installed on a steel plinth (open or closed, available as an optional Miele accessory) or on a concrete plinth.

 Injury can occur if the washing machine has not been adequately secured.

When installing the machine on a plinth, there is the danger of the washing machine falling off the plinth during spinning.

Secure the washing machine using the clamps supplied.

Installation notes

The distances between the machine and the wall are recommendations to help make it easier to carry out service work. If installation space is limited, the machine can also be pushed up against the wall.

This washing machine is not suitable for building under.

 Risk of damage due to moisture ingress.

Moisture can damage electrical components.

Do not install the machine near or directly above an open gully or floor drain.

Installation

Transporting the washing machine to its installation site

⚠ Danger of injury from incorrect transport.

If the washing machine tips up there is a danger of injury to people and damage to property.

Make sure the washing machine is stable during transportation.

Transporting the washing machine with a sack truck

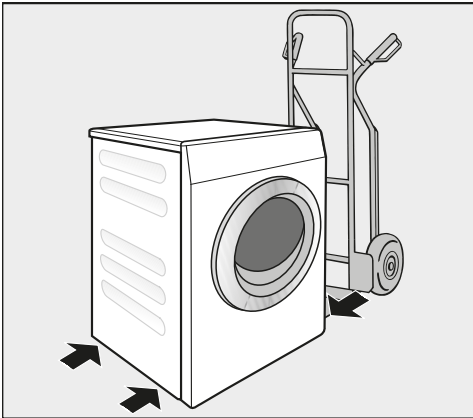

- If transporting the washing machine with a sack truck, make sure its left or right side is resting on the truck.

⚠ Risk of damage from incorrect transport.

The front or back of the washing machine may be damaged if the machine is transported with a sack truck.

Always insert the sack truck under one of the sides of the washing machine.

Transporting the washing machine to its installation site

The protruding lid at the back can be used to hold the machine when transporting.

⚠ Danger of injury due to unsecure lid.

The fixings at the back of the lid could break as a result of external forces. There is a danger of the lid being pulled off when carrying the machine.

Before carrying the machine, check that the lid is secure where it protrudes at the back of the machine.

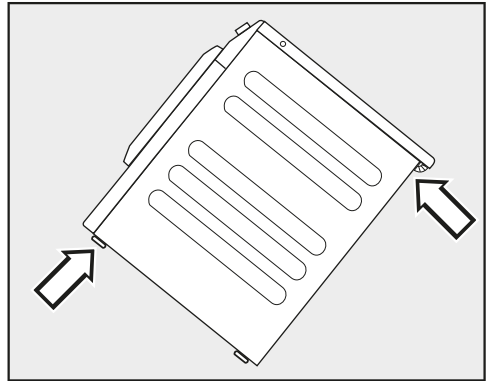

- Carry the washing machine by the front feet and by the lid where it protrudes at the back of the appliance.

Installation surface

A concrete floor is the most suitable installation surface, being far less prone to vibration during the spin cycle than wooden floorboards or a carpeted surface.

- The machine must be level and securely positioned.
- To avoid vibrations during spinning, the machine should not be installed on soft floor coverings.

If installing on a wooden joist floor:

- Install the machine on a plywood base (at least 70 x 60 x 3 cm). The base should span several joists and be bolted to the joists and not only to the floorboards.

Tip: If possible, install the machine in a corner of the room. This is usually the most stable part of the floor.

Removal of transit bars

Removing the left-hand transit bar

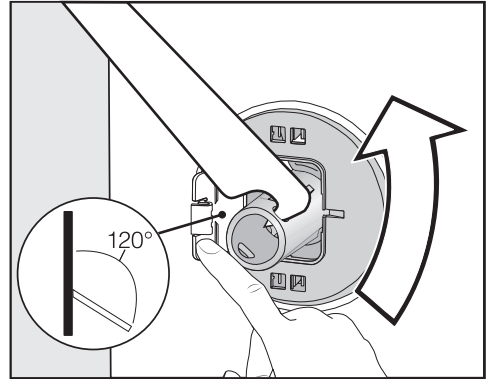

- Push the cover out and turn the transit bar 90° using the open spanner supplied.

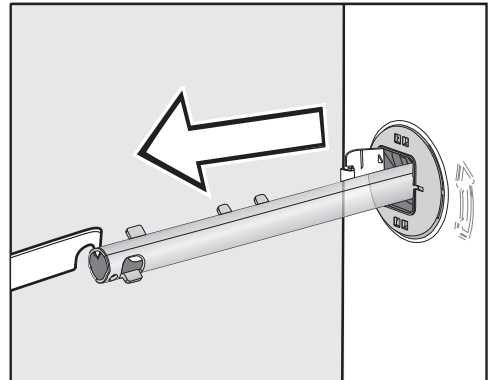

- Pull out the transit bar.

Installation

Removing the right-hand transit bar

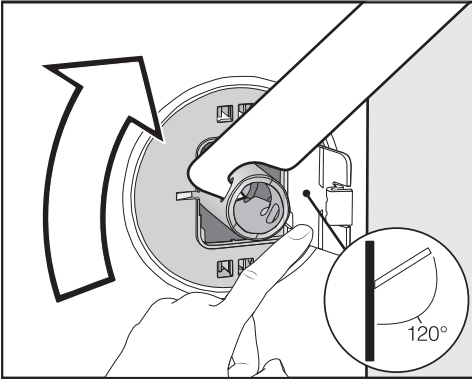

- Push the cover out and turn the transit bar 90° using the open spanner supplied.

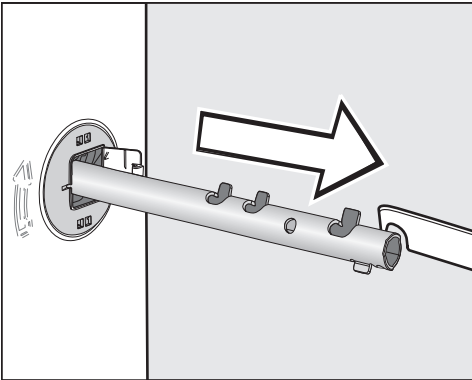

- Pull out the transit bar.

Covering holes

⚠ Danger of injury from sharp edges.

There is a danger of injury from reaching into holes that are not covered.

Cover the holes for the transit bars after they have been removed.

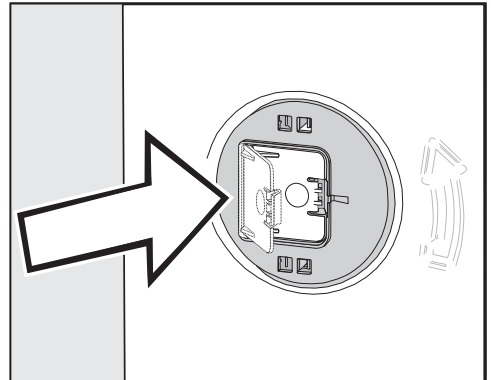

- Push the covers in firmly until they engage in position.

Securing the transit bars

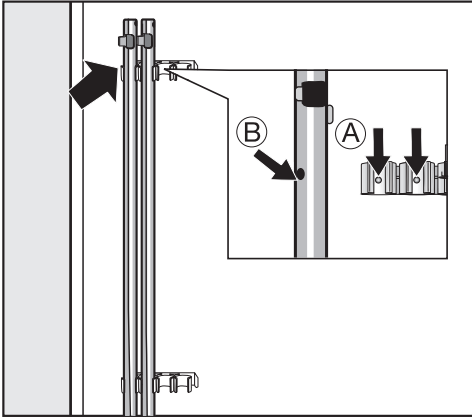

- Secure the transit bars to the back of the washing machine.

Tip: Make sure that the holes (B) are fitted over the retainers (A).

⚠ Risk of damage from incorrect transport.

The washing machine may become damaged if moved without the transit bars in place.

Keep the transit bars in a safe place. Fit them again if the washing machine is to be moved (e.g. when moving house).

Fitting the transit bars

Opening the covers

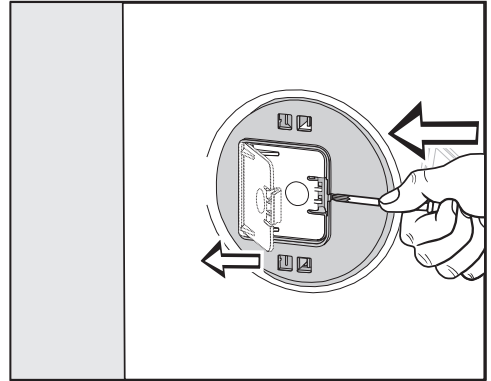

- Press against the retainer with a sharp object (a narrow screwdriver, for example).

The cover opens.

Fitting the transit bars

- To fit the bars, follow the instructions for removing them in reverse order.

Tip: The bars will slide in more easily if you lift the drum slightly.

Installation

Levelling the washing machine

The washing machine must stand perfectly level on all four feet to ensure safe and proper operation.

Incorrect installation may increase electric and water consumption and may cause the machine to move about.

Screwing out and adjusting the feet

The 4 adjustable screw feet are used for levelling the washing machine. The machine is supplied with all four feet screwed in.

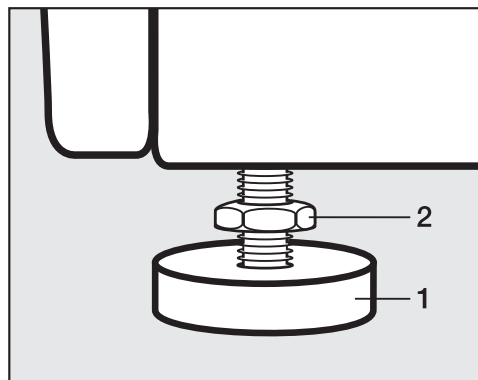

- Using the spanner supplied, turn counter nut **2** in a clockwise direction. Then turn counter nut **2** together with foot **1** to unscrew.

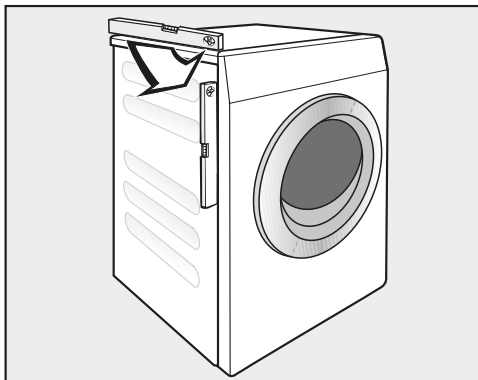

- Use a level to check that the washing machine is standing level.
- Hold foot **1** securely with a pipe wrench. Turn counter nut **2** again using the spanner supplied until it sits firmly up against the housing.

 Risk of damage due to incorrectly aligned washing machine. There is a danger of the washing machine moving about if the feet are not secured.

Turn all 4 counter nuts for the feet until they sit firmly up against the housing. Please also check this for the feet which did not need adjustment.

Holding bracket for plinth

The holding bracket prevents the washing machine from falling off the plinth during operation.

Fastening with the holding bracket is only intended for plinths made from concrete. The plinth must be flat and level. The surface below the plinth must be able to withstand the physical loads. Prior to installation, check whether the plinth complies with the minimum dimensions.

Height: 6 cm

Width: 60 cm

Depth: 65 cm

Positioning the holding bracket

 Risk of injury from sharp edges. The holding bracket has sharp edges. You could cut yourself on the edges. Take care when handling the holding bracket. Wear gloves while installing the holding bracket.

The front appliance feet must protrude by at least 3 mm. The washing machine must already be aligned (see “Installation – Aligning the washing machine”)

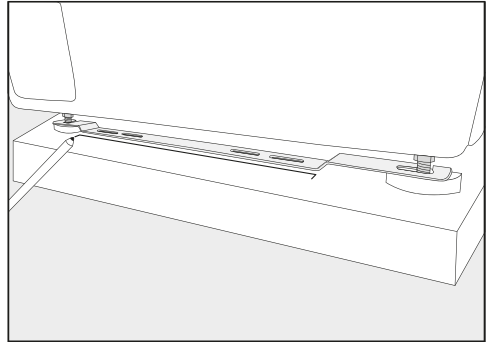

- Place the holding bracket on the front appliance feet.
- Mark the position of the front edge of the holding bracket with a pencil.
- Remove the holding bracket from the feet.
- Carefully move the washing machine until you have enough space to install the holding bracket.

Installation

Installing the holding bracket

- Place the holding bracket on the marking on the plinth.
- In the middle of the two outer slotted holes, mark a point for each drill hole.
- Drill 2 holes (8 mm) with a depth of approx. 55 mm.
- Insert the plugs in the holes.

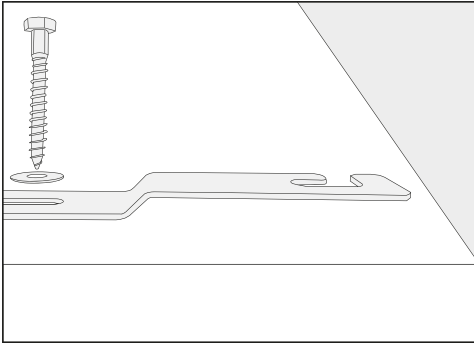

- Install the holding bracket with the hexagon screws and the washers.

Do not tighten the screws yet – this will allow the holding bracket to be moved sideways.

Securing the washing machine with the holding bracket

- Push the washing machine back on to the installed holding bracket.

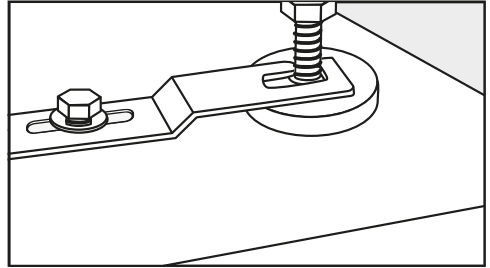

- Insert the appliance feet (the part between the foot and the locknut) into the openings in the holding bracket.
- Push the holding bracket to the right as far as it will go.
- Tighten the hexagon screws using a spanner.

The washing machine is secured in the holding bracket.

External control equipment

The XCI box accessory is needed to connect external control equipment, such as payment systems, dispensing systems or peak load control units.

Payment system

This washing machine can be fitted with a payment system (optional accessory).

The necessary reprogramming must always be carried out by Miele Service or a Miele Service Dealer.

Coins/tokens must be removed from the coin box regularly. Otherwise, the payment system will become blocked.

Installation

Water connection

Cold water connection

The washing machine should be connected to a mains water supply in accordance with current local and national safety regulations. The German authorities do not require it to have a non-return valve as the washing machine has been designed to comply with DIN regulations.

In the U.K. both the hot and cold water supplies must be connected to the mains water connection with the provided double check valve. Hot water temperature must not exceed 60 °C.

The flow pressure must amount to a minimum of 100 kPa and must not exceed 1000 kPa. If the pressure exceeds 1000 kPa, a pressure reducing valve must be installed.

For the connection, a stopcock with a $\frac{3}{4}$ " screw thread is required. If this type of stopcock is not available, only a qualified installer may connect the washing machine to the mains water supply.

The connection point is subject to mains water pressure. Turn on the stopcock slowly and check for leaks. Correct the position of the washer and screw thread if appropriate.

Switching to cold water operation

If the washing machine is not connected to a hot water point, you will have to configure the settings *Main wash water*, *Pre-wash water* and *Rinse water* to cold (see "Supervisor level").

- Unscrew the hot water hose.
- Screw on the stopper provided.

Maintenance

Only use genuine Miele hoses that have been tested to withstand pressure of at least 7000 kPa should you ever need a replacement.

A filter is located in the intake point to protect the water inlet valve. Neither filter may be removed.

Hose extension

Longer hoses are available from Miele or from your Miele dealer as accessories.

Hot water connection*

The hot water temperature must not exceed 70 °C (60 °C in the UK).

To minimise energy consumption during operation with hot water, the washing machine should be connected to a suitable hot water ring circuit. So-called “transmission pipes” (single pipes to hot water generators) can result in any water remaining in the pipes cooling down if not in constant use. More energy would then be consumed to heat the liquid up again.

The same connection requirements as for cold water also apply to hot water.

The inlet hose is connected to the stopcock.

The washing machine cannot only be connected to a hot water connection.

* Some machine versions do not come with a hot water hose.

Switching to hot water operation

If the washing machine is due to be connected to a hot water point, you can configure the settings *Main wash water*, *Pre-wash water* and *Rinse water* to hot (see “Supervisor level”).

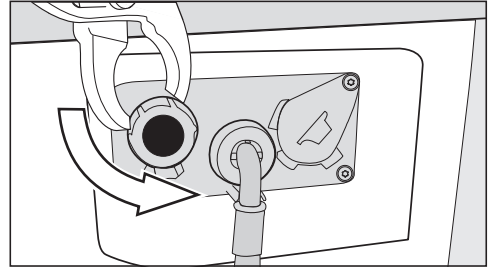

- Unscrew the stopper from the hot water valve.
- Screw on the hot water hose.

Drainage

Drain valve

The machine is drained using a motorised drain valve. A DN 70 angle connector can be used for draining the machine via an on-site floor drain (gully with odour trap).

Installation

Electrical connection

This description applies to washing machines both with and without a mains plug.

The following applies to washing machines with a mains plug:

- The washing machine is ready to be connected.
- The electrical socket must be easily accessible after installation so that the machine can be disconnected from the electricity supply if necessary.

 Damage caused by incorrect supply voltage.

The data plate indicates the nominal power consumption and the appropriate fuse rating.

Compare the specifications on the data plate with those of the mains electricity supply and make sure that they match.

The washing machine may only be connected to a permanent electrical system that conforms to the national and local codes and regulations.

Do not connect the machine to an extension lead or multi-socket adapter as they do not guarantee the required safety of the appliance (e.g. danger of overheating).

If the machine is hard wired, an all pole circuit breaker must be provided on-site. When switched off there must be an all-pole contact gap of at least 3 mm in the isolator switch (including miniature circuit breaker, switch, fuses and

relays according to IEC/EN 60947). This connection process must be performed by a qualified electrician.

The plug connector or isolator switch should be easily accessible at all times.

 Risk of electric shock.

If the washing machine is disconnected from the mains, protective measures must be taken to ensure that the point of disconnection cannot accidentally be switched on again.

Make sure the isolator is lockable or the point of disconnection is monitored at all times.

New connections, modifications to the system, or servicing of the earthing conductor, including determining the correct fuse amperage, must be carried out by a qualified electrician, as they are familiar with the pertinent regulations and the specific requirements of the electric utility company.

If converting the washing machine to an alternative voltage, observe the instructions in the wiring diagram. Conversion must be performed by Miele Service or by an authorised Miele dealer.

Single phase AC 230 V – country variant 230V 25A

This device is intended for connection to a power supply system where the maximum value of external phase neutral loop impedance Z_{max} of 0.38 Ohms at the point of distributor supply connection is not exceeded.

The user has to ensure that this device is connected only to a power supply system which fulfils the requirement above. If in doubt, please ask your electrical distributor for actual impedance value.

Technical data

Height	850 mm
Width	596 mm
Width (machines with a stainless steel lid)	605 mm
Depth	714 mm
Depth with door open	1132 mm
Weight	Approx. 100 kg
Maximum floor load in operation	3000 Newton
Capacity	8.0 kg dry laundry
Supply voltage	See data plate on back of machine
Rated load	See data plate on back of machine
Fuse rating	See data plate on back of machine
A-rated sound emissions L_{pA} in accordance with EN ISO 11204/11203	< 70 dB re 20 μ Pa
Minimum water flow pressure	100 kPa (1 bar)
Maximum water flow pressure	1000 kPa (10 bar)
Intake hose length	1.55 m
Power cable length	1.80 m
Product safety standard	EN 50571, EN 60335
Test certifications awarded	See data plate
Frequency band of the WiFi module	2.4000 GHz – 2.4835 GHz
Maximum transmission power of the WiFi module	< 100 mW

EU Conformity declaration

Miele hereby declares that this washing machine complies with Directive 2014/53/EU.

The complete text of the EU declaration of conformity is available from one of the following internet addresses:

- Products, Download from www.miele.co.uk
- For service, information, operating instructions etc: go to www.miele.co.uk/domestic/customer-information-385.htm and enter the name of the product or the serial number

UK Conformity declaration

Miele hereby declares that this washing machine complies with UK Radio Equipment Regulations 2017, as amended.

The complete text of the UK declaration of conformity is available from one of the following internet addresses:

- Products, Download from www.miele.co.uk
- For service, information, operating instructions etc: go to www.miele.co.uk and enter the name of the product or the serial number

This **Statement of Compliance** confirms this Miele product fully complies with the **Product Security and Telecommunications Infrastructure (Security Requirements for Relevant Connectable Products) Regulations 2023**.

- 1) Household Appliance – *Professional Washing Machine GW06, GW08*
- 2) Manufactured by: Miele & Cie KG,
Carl Miele Street 29, 33332 Gutersloh Germany
Imported by and contact point: Miele Company Ltd, Fairacres, Marcham Road,
Abingdon, Oxon, OX14 1TW Great Britain
- 3) The defined support period at the time of first supply is 10 years
- 4) To report vulnerabilities and cybersecurity issues please contact: psirt@miele.com
- 5) Signature 
Name: **Paul Wright**
Company Position: **Head of Technical Management**
Date of signature: **19th March 2024**
Place of signature: **Abingdon, Oxfordshire**

Supervisor level

The settings menu in the  Supervisor level is locked against unauthorised access. The menu can be unlocked with a code.

Code-based access

Supervisor level is accessed using a code.



The code is **000** (factory default).

Changing the code

You can alter the Supervisor level access code to protect the washing machine from unauthorised access.

Please inform Miele Service if you have forgotten your new code. Miele Service will have to reset the code. Make a note of your new code and store it in a safe place.

Accessing supervisor level

- Turn the programme selector, e.g. to the *Mops 60 °C* programme.
- Touch the *Further choices*  sensor control.
- Touch the *Supervisor level*  sensor control.

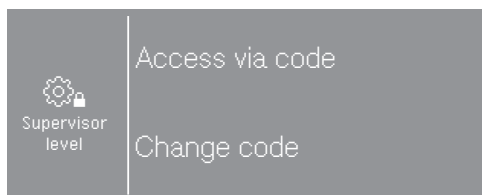

- Select Access via code.

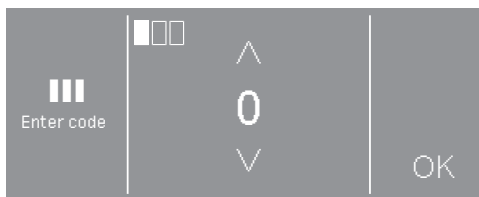

- Enter the individual numbers and confirm each selection with OK.

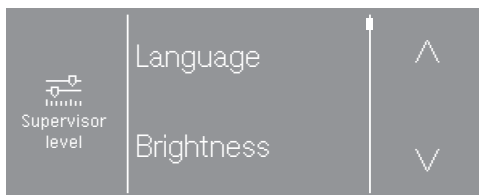

- Select the setting you want.

Some settings are only visible if external devices are connected via the XCI box.

Exiting the Supervisor level

- Touch the  sensor or switch off the washing machine.

Language

The display can be set to appear in one of several different languages. To select the permanent operator language you want, go to the Languages sub-menu.

When a programme is running, you can change the user language using the  sensor.

Brightness

The brightness of the display can be set in intervals of ten from 10 % to 100 %.

Factory default: 70 %

Clock display

After selecting the clock format, you can set the time of day.

Clock format

- 24 h clock (factory default)
- 12 h clock
- Clock off

Set

- The time of day can be set.

Finish tone volume

The volume can be changed for the buzzer that sounds at the end of the programme.

It can be set to one of 7 different levels or switched off altogether.

Factory default: Off

Keypad tone volume

The volume of the tone that sounds when a sensor is touched can also be changed.

It can be set to one of 7 different levels or switched off altogether.

Factory default setting: normal

Welcome tone volume

The volume of the welcome tone that sounds when the washing machine is switched on can be changed.

It can be set to one of 7 different levels or switched off altogether.

Factory default setting: normal

Fault alarm

The tone that sounds in the event of a fault can be switched on or off.

Factory default: Off

Memory

The washing machine will save the settings (temperature, spin speed and some of the options) which have been selected for a programme after the programme has started.

When the programme is chosen again, the saved settings will appear in the display.

Factory default: Off

Supervisor level

Anti-crease

The Anti-crease function reduces creasing after the end of the programme.

At the end of the programme, the drum continues to turn at intervals for up to 30 minutes. The washing machine door can be opened at any time.

Factory default: On

Suds cooling

Additional water flows into the drum at the end of the main wash to cool the suds down.

Suds cooling takes place when a programme with a temperature of 70 °C or higher is selected.

Suds cooling should be activated:

- To prevent the danger of scalding if the drain hose is hooked over the edge of a sink or basin.
- Where the drainage pipes do not comply with DIN 1986.

Factory default: On

"Display" switch-off status

To save energy, the display goes out and the *Start/Stop* button flashes slowly.

Changing this setting leads to increased energy consumption.

- Off
The display will remain on.
- On after 10 min, not in current programme (factory default)
The display will remain on while the programme is running but will go out 10 minutes after the end of the programme.
- On after 30 min, not in current programme
The display will remain on while the programme is running but will go out 30 minutes after the end of the programme.
- On after 10 min
The display will go out after 10 minutes.
- On after 30 min
The display will go out after 30 minutes.

"Machine" switch-off status

The washing machines switches itself off automatically. It is switched off after the end of the programme/Anti-crease phase, or after being switched on if no further selection is made.

Changing this setting leads to increased energy consumption.

- No switch off
- Switch off after 15 minutes
- Switch off after 20 minutes
- Switch off after 30 minutes (factory default)

Delay start

The type of time input for the Delay start function can be changed or switched off.

- Off
The Delay start function is not available for selection.
- End of programme (factory default)
With the Delay start function, you specify at what time the wash programme should end.
- Beginning of programme
With the Delay start function, you specify at what time the wash programme should begin.
- Time until start
With the Delay start function, you specify after how many hours a programme should begin.

Programme name

When selecting a standard programme, the name of the selected programme is shown in the display.

- On (factory default)
When a programme is selected, the programme name is displayed for a few seconds before the display shows the main menu.
- Off
The main menu is displayed immediately.

Visibility parameters

Various parameters are offered/displayed when a programme is selected. You can decide which parameters should not be displayed. These parameters can then not be edited during programme selection.

Factory default: all parameters are visible.

Pre-wash water

You can select the water type for the pre-wash.

- Cold
Only cold water is used for the pre-wash.
- Hot
Hot water is also added for the pre-wash.
Hot water can only be added if the wash temperature is above 30 °C.

Supervisor level

Main wash water

You can select the water type for the main wash.

- Cold
Only cold water is used for the main wash.
- Hot
Hot water is also added for the main wash.
Hot water can only be added if the wash temperature is above 30 °C.

Programme durations will be longer if the machine is not connected for hot water; this may mean that the “Time left” display is incorrect.

First rinse water

You can select the water type for the first rinse in some programmes.

- Cold (factory default)
Only cold water is used for the first rinse.
- Hot
Hot water is also added for the first rinse.

Final rinse water

You can select the water type for the last rinse in some programmes.

- Cold (factory default)
Only cold water is used for the final rinse.
- Hot
Hot water is also added for the final rinse (only possible for programmes with a temperature of at least 60 °C).

Low water pressure

If the water pressure is below 100 kPa (1 bar), the programme will be cancelled and the fault message **Check water inlet** will appear.

If the on-site water pressure cannot be increased, activating the setting **Low water pressure** will prevent the programme from being cancelled.

Factory default: On

Pre-spin mops

In the standard mop programmes, wet mops are spun briefly at the start of the programme to remove surplus water.

Factory default: On

Mops temp. Standard plus

The pre-set temperature can be altered in the *Mops plus* and *Mops plus + rtu* programmes.

- 40 °C (factory default)
- 60 °C
- 70 °C
- 90 °C

Mops Chemo-thermal disin.

The pre-set disinfection process can be altered in the *Mops chemo-thermal disinfection* programme.

- 40 °C/20 min
- 60 °C/20 min (factory default)
- 70 °C/10 min

Mops Th.-disin.

The pre-set disinfection process can be altered in the *Mops thermal disinfection* programme.

- 75 °C/10 min
- 85 °C/15 min (factory default)

Microfibre mops

The Microfibre Extra can be selected for the mop programmes.

- Inactive, not visible
- Can be selected, visible (factory default)
- Active, not visible

Mops, pre-treat rpm

The pre-set spin speed can be altered in Finish/Pre-treat mop programmes.

- 300 rpm
- 400 rpm
- 600 rpm
- 800 rpm (factory default)

Cloths temp Standard plus

The preset temperature can be altered in the *Cloths plus* and *Cloths plus + rtu* programmes.

- 40 °C
- 60 °C (factory default)
- 70 °C
- 90 °C

Supervisor level

Cloths Ch-th. disin.

The pre-set disinfection process can be altered in the *Cloths chemo-thermal disinfection* programme.

- 40 °C/20 min
- 60 °C/20 min (factory default)
- 70 °C/10 min

Pre-treat cloths rpm

The preset spin speed can be altered in Finish/Pre-treat cloth programmes.

- 600 rpm
- 800 rpm (factory default)
- 1000 rpm
- 1200 rpm

Empty sensor

A siphon contact can be used to detect whether external detergent containers are empty. A message appears if a container is empty.

- Off (factory default)
The Empty sensing function is switched off.
- Normally open contact
The siphons are equipped with a normally open contact.
- Normally closed contact
The siphons are equipped with a normally closed contact.

Early warning counter

An internal counter reports when an external dispenser container is almost empty. The counter in question then has to be reset.

Water level Cottons

You can increase the water level for the main wash in the *Cottons* programme.

- + 0 mm wc (factory default)
- + 10 mm wc
- + 20 mm wc
- + 30 mm wc

Water level Minimum iron

You can increase the water level for the main wash in the *Minimum iron* programme.

- + 0 mm wc (factory default)
- + 10 mm wc
- + 20 mm wc
- + 30 mm wc

Cottons Pre-wash temp

You can select the temperature for the pre-wash in the *Cottons* programme.

- 30 °C (factory default)
- 35 °C
- 40 °C
- 45 °C

Wash time Pre-wash

You can increase the duration for the pre-wash in the *Cottons* programme.

- + 0 min (factory default)
- + 6 min
- + 9 min
- + 12 min

Wash time Cottons

You can increase the duration for the main wash in the *Cottons* programme.

- + 0 min (factory default)
- + 10 min
- + 20 min
- + 30 min
- + 40 min

Wash time Minimum iron

You can increase the duration for the main wash in the *Minimum iron* programme.

- + 0 min (factory default)
- + 5 min
- + 10 min
- + 15 min
- + 20 min

Pre-rinse Cottons

A pre-rinse can be activated in the *Cottons* programme.

Factory default: Off

Pre-rinse Minimum iron

A pre-rinse can be activated in the *Minimum iron* programme.

Factory default: Off

Pre-wash Cottons/Min. iron

In the programmes *Cottons* and *Minimum iron*, you can choose whether a pre-wash is permanently activated or whether it can be selected during programme selection.

Factory default: Menu selection

Supervisor level

Cottons rinses

You can alter the number of rinse cycles carried out in the *Cottons* and standard mop programmes.

- 1 rinse cycle
- 2 rinse cycles (factory default)
- 3 rinse cycles
- 4 rinse cycles
- 5 rinse cycles

Min. iron rinses

You can alter the number of rinses carried out in the *Minimum iron* programme.

- 2 rinses (factory default)
- 3 rinses
- 4 rinses

Disinfection rinse

Additional rinses can be activated in disinfection programmes with a temperature of at least 60 °C.

Rinsing is carried out with hot water. The programme duration is longer.

The laundry may feel hot at the end of the programme.
Take care when removing items.

Factory default: Off

Programme packages

The selection of programmes can be expanded by activating single programmes from the programme packages.

The programmes selected from the programme packages are displayed under *Further programmes* .

- Standard
- Pre-treat mops
- Pre-treat cloths
- Ready to use
- Workwear
- Standard programmes

After selecting the programme packages, the individual programmes from the list are activated (activated programmes are marked with a frame). The selection must then be confirmed.

Disinfection prog. code

A code has to be entered to cancel a disinfection programme. The code can be modified.

The code is: 0 0 0

Tip: Make a note of your new code if you ever change it.

Temp reduction

The suds temperature can be reduced to prevent the suds from boiling too early in high-altitude locations.

Factory default: Off

Automatic dispensing

Automatic dispensing via an external dispensing system can be activated

Factory default: Off

Adjustment value dosage 1–6

To respond to the tolerances that occur in the pump system over time, the dosage amount (ml/min) for the pumps can be corrected.

The calibration value can be reduced by 3 increments or increased by 3 increments.

The calibration value is increased or reduced by 1, 2 or 3 times the adjustment value based on the selected incremental setting.

The calibration value and the adjustment value must be added to the data for the dispenser pumps by the Miele Customer Service Department.

COM module selection

This washing machine is equipped with an integrated WiFi module. However, the washing machine can also be equipped with an external module.

- Off (factory default setting)
- Internal module
- External module

The internal WiFi module is used.

An XKM module or RS232 module is inserted into the module slot.

Supervisor level

Availability of Miele digital products

The ability of Miele digital products depends on the availability of the services in your country.

The different services are not available in all countries.

For information about availability, please visit www.miele.com.

WiFi/LAN

Control the networking of your washing machine.

- Setup

This message only appears if the washing machine has not yet been connected to a WiFi network.

- Deactivate (visible if the network is activated).

The network remains set up; the WiFi function is switched off.

- Activate (visible if the network is deactivated).

The WiFi function is reactivated.

- Connection status (visible if the network is activated)

– The quality of WiFi reception

– The network name

– The IP address

- Set up again (visible if already set up).

Resets the WiFi login (network) to immediately re-establish a new connection.

- Reset (visible if already set up)

The network is no longer set up. A new connection has to be established in order to use the network again.

– The WiFi is switched off.

– The WiFi connection will be reset to the factory default setting.

WiFi setup

There are 2 possible connection methods.

WPS

■ Activate the WPS function on your router within 2 minutes.

Tip: If the connection has not been set up when the timeout has finished counting down, repeat the process.

Soft AP

■ Activate the function with the Miele app on your smart device within 10 minutes.

Tip: The app will guide you through the remaining steps.

Network time

The date and time can be synchronised over the network.

- Off

The date and time are not synchronised over the network.

- As master

The machines are in a network but are not connected to the Internet. A machine is declared as the master and sends data to the *slave* devices.

- As slave

The machines are in a network and are connected to the Internet. All machines are configured as *slaves*. Data is synchronised over the Internet.

External programme lock

The control unit has an option to block programmes. Programmes are blocked by an external system via the COM interface.

Factory default: Off

Peak load signal

The peak-load negotiation function enables the washing machine to be connected to an energy management system. When a signal is registered, the washing machine's heater is switched off for a short period. The washing machine may only be operated with a peak-load system if this system is connected to the washing machine via the Miele XCI box.

- No function (factory default)

- Peak load with 230 V

- Peak load with 0 V

Peak load prevention

The peak-load negotiation function can be deactivated with disinfection programmes. When a signal is registered, the washing machine's heater is not switched off.

Factory default: Off

Supervisor level

Remote

Operating data relating to the washing machine (e.g. fault messages or notifications) is communicated externally.

Factory default: On

RemoteUpdate

The RemoteUpdate function is used to update the software in your washing machine.

RemoteUpdate is activated by default.

If you do not install a RemoteUpdate, you can continue to use your washing machine in the usual way. However, Miele recommends installing RemoteUpdates.

Running a RemoteUpdate

If a RemoteUpdate is available for your washing machine, it will be displayed automatically when the operator level is open.

You can choose to start the RemoteUpdate immediately or wait until later. If you select “Start later”, the prompt to run the RemoteUpdate will be displayed again the next time you switch on your washing machine.

The RemoteUpdate can take a few minutes.

Please note the following information about the RemoteUpdate function:

- You will only receive a message when a RemoteUpdate is available.
- Once a RemoteUpdate has been installed, it cannot be undone.

- Do not switch off the washing machine during a RemoteUpdate. Otherwise, the RemoteUpdate will be aborted and will not be installed.

SmartGrid

You can use the SmartGrid setting to integrate your washing machine into building energy management systems.

Factory default: Off

Controlled energy consumption

In the *Whites*, *Coloured items* and *Minimum iron* programmes, the machine will optimise the energy it uses if Controlled energy consumption is selected.

Factory default: On

Alternating current

The time left display depends on the electrical connection. If a single-phase connection is used, the setting must be switched to *No*.

Factory default: Yes

Heating

The heating can be switched off and the Thermostop step is skipped. In addition, heater fault monitoring is deactivated.

Factory default: On

Legal information

[Open source licences](#)

You can view information here.

Copyrights and licences for operator and control software

Miele uses their own and third party software which is not subject to any so-called open source licence for the operation and control of the machine. This software/these software components are protected by copyright. The copyright powers of Miele and third parties have to be respected.

Furthermore, this machine contains software components which are distributed under open source licence conditions. Please refer to the menu item [Settings](#) | [Machine parameters](#) | [Legal information](#) | [Open source licences](#) in the machine for the Open Source components contained therein, together with the corresponding copyright notices, copies of the licencing conditions valid at the time, and any further information. The liability and warranty provisions of the Open Source licence terms and conditions as stated therein apply only in relation to the respective rights holders.

Supervisor level

Payment system

The XCI-AD or XCI box accessory unit is required to connect a payment system.

If you wish to change the settings after the commissioning process, please contact the Miele Customer Service Department.

Settings for payment systems

You would like to connect a payment system.

- No payment system

The next settings are skipped and initial commissioning can be completed.

- Programme operation

The machine is operated using a coin box. The user purchases a wash programme.

- Timed operation

The machine is operated using a coin box. The user purchases a time-managed programme.

- COM module

The machine is operated by a central control unit.

Feedback signal to pay system

Setting the feedback signal for the coin box.

- Factory default: Off

- End of programme

The feedback signal is sent at the end of the programme.

- Release of the start button

The feedback signal is sent when the start button is released.

- Start and programme end

The feedback signal is sent at the start and end of the programme.

- Programme running

The feedback signal is sent constantly between the start and end of the programme.

Payment system lock

To avoid tampering, a programme lock can be set up in programme control. If the lock is applied, the programme is interrupted and payment credit is lost as soon as the door is opened.

The time for the lock to be applied can be adjusted to enable laundry to be added.

- Off
- As soon as the programme starts
- 1 minute after the start of the programme
- 2 minutes after the start of the programme
- 3 minutes after the start of the programme (factory default)
- 4 minutes after the start of the programme
- 5 minutes after the start of the programme

FOC programmes

In coin mode, you can decide whether the Drain/Spin programme can be used for free.

Factory default: Off

Delete paid signal

The "Paid" signal in coin box mode can be applied until the end of the programme or discarded if the programme is not started after 5 minutes.

Factory default: Off

Debounce time

In coin mode, the debounce time for the minimum payment signal that must be applied can be adjusted.

- Factory setting: Short
For coin boxes where the falling coin generates the paid pulse.
- Long
For central control units on a 230 V basis.

United Kingdom

Miele Co. Ltd., Fairacres, Marcham Road
Abingdon, Oxon, OX14 1TW
Professional Sales, Tel: 0845 365 6608
E-mail: professional@miele.co.uk
Internet: www.miele.co.uk/professional

Australia

Miele Australia Pty. Ltd.
ACN 005 635 398, ABN 96 005 635 398
Level 4, 141 Camberwell Road, Hawthorn East, VIC 3123
Tel: 1300 731 411
Internet: www.miele.com.au/professional
E-mail: sales@miele-professional.com.au

China Mainland

Miele Electrical Appliances Co., Ltd.
1-3 Floor, No. 82 Shi Men Yi Road
Jing' an District, 200040 Shanghai, PRC
Tel: +86 21 6157 3500, Fax: +86 21 6157 3511
E-mail: info@miele.cn, Internet: www.miele.cn

Hong Kong, China

Miele (Hong Kong) Ltd.
41/F - 4101, Manhattan Place
23 Wang Tai Road, Kowloon Bay, Hong Kong
Tel: (852) 2610 1025, Fax: (852) 3579 1404
Email: customerservices@miele.com.hk
Website: www.miele.hk

India

Miele India Pvt. Ltd.
1st Floor, Copia Corporate Suites,
Commercial Plot 9, Mathura Road, Jasola,
New Delhi - 110025
E-mail: customercare@miele.in, Website: www.miele.in

Ireland

Miele Ireland Ltd.
2024 Bianconi Ave., Citywest Business Campus, Dublin 24
Tel: (01) 461 07 10, Fax: (01) 461 07 97
E-Mail: info@miele.ie, Internet: www.miele.ie

Malaysia

Miele Sdn Bhd
Suite 12-2, Level 12
Menara Sapura Kencana Petroleum
Solaris Dutamas No. 1, Jalan Dutamas 1
50480 Kuala Lumpur, Malaysia
Phone: +603-6209-0288
Fax: +603-6205-3768

New Zealand

Miele New Zealand Limited
IRD 98 463 631
8 College Hill
Freemans Bay, Auckland 1011, NZ
Tel: 0800 464 353
Internet: www.miele.com.au/professional
E-mail: sales@miele-professional.com.au

Singapore

Miele Pte. Ltd.
29 Media Circle, #11-04 ALICE@Mediapolis
Singapore 138565
Tel: +65 6735 1191, Fax: +65 6735 1161
E-Mail: info@miele.com.sg
Internet: www.miele.sg

South Africa

Miele (Pty) Ltd
63 Peter Place, Bryanston 2194
P.O. Box 69434, Bryanston 2021
Tel: (011) 875 9000, Fax: (011) 875 9035
E-mail: info@miele.co.za
Internet: www.miele.co.za

United Arab Emirates

Miele Appliances Ltd.
Showroom 1, Eiffel 1 Building
Sheikh Zayed Road, Umm Al Sheif
P.O. Box 114782 - Dubai
Tel. +971 4 3044 999, Fax. +971 4 3418 852
800-MIELE (64353)
E-Mail: info@miele.ae, Website: www.miele.ae



Manufacturer: Miele & Cie. KG
Carl-Miele-Straße 29, 33332 Gütersloh, Germany

PWM 508 Mop Star 80

en-GB

M.-Nr. 12 131 780 / 01