

Operating and Installation Instructions Electric Cooktops



To prevent accidents and machine damage, read these instructions **before** installation or use.

IMPORTANT SAFETY INSTRUCTIONS	5
Caring for the environment	16
Overview	17
Cooktop.....	17
Control elements/indicators	18
Cooking zone data	20
Before first use	21
Cleaning the cooktop for the first time.....	21
Turning on the cooktop for the first time	21
How the cooking zones work	22
Cookware	23
Energy saving tips	24
Setting range	25
Operation	26
Basic operation	26
Switching the cooktop on	27
Switching the cooking zone on, setting/changing the power level.....	27
Switching off.....	27
Residual-heat indicator	27
Setting the power level – extended power level range.....	27
Extension.....	28
Auto Heat-up.....	29
Timer	30
Timer	30
Switching off a cooking zone automatically.....	32
Using both timer functions at the same time	33
Additional functions	34
Stop & Go.....	34
Safety features	35
System lock/Safety lock.....	35
Safety shut-off.....	36
Overheating protection.....	37
Cleaning and care	38

Contents

Programming	40
Frequently Asked Questions	43
Optional accessories	46
Customer Service	47
Contact in the event of a fault	47
Appliance warranty and product registration	47
Installation	48
IMPORTANT SAFETY INSTRUCTIONS - INSTALLATION	48
Safety distances.....	49
Installation notes	53
Installation dimensions.....	54
Installation	55
Electrical connection	57
MieleCare	59

IMPORTANT SAFETY INSTRUCTIONS

This cooktop complies with all relevant local and national safety requirements. Inappropriate use can, however, lead to personal injury and material damage.

Read the operating and installation instructions carefully before using the cooktop. They contain important information on safety, installation, use and maintenance. This prevents both personal injury and damage to the cooktop.

When installing the cooktop, Miele expressly and strongly advises that you read and follow the instructions under “Installation”, as well as in the “IMPORTANT SAFETY INSTRUCTIONS”.

Miele cannot be held liable for injury or damage caused by non-compliance with these instructions.

Keep these instructions in a safe place and pass them on to any future owner.

IMPORTANT SAFETY INSTRUCTIONS

Appropriate use

- ▶ This cooktop is intended for domestic use and use in other similar environments.
- ▶ This cooktop is not intended for outdoor use.
- ▶ The cooktop is intended for domestic use only to prepare food and keep it warm. Any other use may be dangerous.
- ▶ Persons (including children) who lack physical, sensory or mental abilities, or experience with the appliance should not use it without supervision or instruction by a responsible person.

IMPORTANT SAFETY INSTRUCTIONS

Safety with children

- ▶ As with any other appliance, children must be supervised.
- ▶ Do not leave children unattended: Children should not be alone or unsupervised in the area where the appliance is installed. Do not allow them to sit or stand on the appliance.
- ▶ Be sure to supervise any children in the vicinity of the cooktop, and do not let them play with it.
- ▶ The cooktop gets hot when in use and remains hot for some time after being turned off. Keep children away from the appliance until it has cooled down and is no longer a burn hazard.
- ▶ Danger of burning. Do not store anything which might arouse a child's interest in storage areas above or behind the cooktop. Otherwise they could be tempted to climb onto the appliance.
- ▶ Risk of burning or scalding. Turn pot and pan handles inward, so children cannot pull them down and be burned.
- ▶ Danger of suffocation. While playing, children may become entangled in packaging material (such as plastic wrapping) or pull it over their head, presenting the risk of suffocation. Keep packaging material away from children.
- ▶ Activate the system lock to ensure that children cannot turn on the appliance inadvertently. Use the safety lock when the hob is in use to prevent children from altering the settings selected.

IMPORTANT SAFETY INSTRUCTIONS

Technical safety

- ▶ Unauthorized installation, maintenance, and repairs can cause considerable danger for the user. Installation, maintenance, and repairs must only be carried out by a Miele authorized technician.
- ▶ Maintenance by the user: Never repair or replace any part of the appliance unless the instructions specifically recommend doing so. Service work should only be performed by a qualified technician.
- ▶ Damage to the cooktop can compromise your safety. Check the cooktop for visible signs of damage. Do not use the cooktop if it is damaged.
- ▶ Reliable and safe operation of the cooktop can only be guaranteed if it is connected to the public power supply.
- ▶ Be certain your appliance is properly installed and grounded by a qualified technician. To guarantee the electrical safety of this appliance, continuity must exist between the appliance and an effective grounding system. It is imperative that this basic safety requirement be met. If there is any doubt, have the electrical system of the house checked by a qualified electrician.
- ▶ Proper installation: Make sure that your appliance has been installed correctly and that it has been grounded by a qualified technician.
- ▶ To avoid damaging the cooktop, make sure that the connection data (voltage and frequency) on the data plate correspond to the building's power supply before connecting the appliance. When in doubt, consult a qualified electrician.
- ▶ Do not connect the appliance to the electrical supply with a power bar or extension cord. These are a fire hazard and do not guarantee the required safety of the appliance.
- ▶ For safety reasons, the cooktop may only be used when it has been fully installed.

IMPORTANT SAFETY INSTRUCTIONS

- ▶ This appliance must not be used in a non-stationary location (e.g. on a ship).
- ▶ Any contact with live connections or tampering with the electrical or mechanical components of the cooktop will endanger your safety and may lead to appliance malfunctions.
Do not open the casing of the cooktop under any circumstances.
- ▶ Any repairs not performed by a Miele authorized service technician will void the warranty.
- ▶ Defective components should be replaced by Miele original parts only. Only with these parts can safety of the appliance be assured as intended by the manufacturer.
- ▶ The appliance is not intended for use with an external timer switch or a remote control system.
- ▶ The cooktop must be connected to the electricity supply by a qualified electrician (see “Installation – Electrical connection”).
- ▶ If the power cord is damaged, it must only be replaced by a qualified service technician (see “Installation – Electrical connection”).
- ▶ The appliance must be completely disconnected from the electricity supply during installation, maintenance and repair work. Ensure that power is not supplied to the appliance until after it has been installed or until any maintenance or repair work has been carried out.
Disconnect by
 - removing the fuse,
 - “tripping” the circuit breaker, or
 - unplugging the unit (if equipped with plug). Pull the plug not the cord.
- ▶ Danger of electric shock. Do not use the cooktop if it is faulty, or if the ceramic surface is cracked, chipped, or damaged in any way. Switch it off immediately. Disconnect the cooktop from the electrical power supply. Contact Miele Service.

IMPORTANT SAFETY INSTRUCTIONS

- ▶ If the cooktop is installed behind a cabinet door, do not close the door while the cooktop is in operation. Heat and moisture can build up behind the closed door and cause damage to the cooktop, cabinetry, and flooring. Do not close the door until the residual heat indicators go out.
- ▶ Do not open the cooktop housing under any circumstances.
- ▶ Disconnect the cooktop from the electrical power supply before carrying out any maintenance or repair work.

IMPORTANT SAFETY INSTRUCTIONS

Correct use

- ▶ DO NOT TOUCH SURFACE UNITS OR AREAS NEAR UNITS – Surface units may be hot even though they are dark in color. Areas near surface units may become hot enough to cause burns. During and after use, do not touch, or let clothing or other flammable materials contact surface units or areas near units until they have had sufficient time to cool. Among these areas are (identification of areas – for example, the cooktop and surfaces facing the cooktop).
- ▶ The cooktop gets hot when in use and remains hot for a while after being turned off. There is a potential hazard until the residual heat indicator goes out.
- ▶ Do not leave the cooktop unattended when cooking on high power. Spilled food will begin to smoke and cause grease splatter, which can ignite on the cooktop. Doing so may result in carbon monoxide poisoning and overheating of the appliance.
- ▶ When in use, the cooktop emits a significant amount of heat, which can cause objects in the vicinity to catch fire. Never use the cooktop to heat the room.
- ▶ Oil and fat can catch fire if overheated. Never leave the appliance unattended when cooking with oil and fat. If the oil or fat catches fire, do not attempt to put the flames out with water. Turn off the cooktop and smother the flames using a lid or a suitable fire blanket.
- ▶ Smother the fire or flames, or use a dry chemical extinguishing agent or foam fire extinguisher.
- ▶ Storage in or on the appliance: Flammable materials should not be stored in an oven or in the vicinity of the cooktop.
- ▶ The flames could set the grease filters of a ventilation hood on fire. Do not flambé under a ventilation hood.

IMPORTANT SAFETY INSTRUCTIONS

- ▶ Spray canisters, aerosols and other inflammable substances can ignite when heated. Therefore do not store such items or substances in a drawer under the appliance. Cutlery inserts must be heat-resistant.
- ▶ Never heat empty cookware.
- ▶ Do not heat or can food in closed containers, such as tins or sealed jars, on the cooktop, as pressure will build up in the container and cause it to explode.
- ▶ If the cooktop is covered, there is a risk that the material of the cover will ignite, explode or melt if the cooktop is still hot or if turned on inadvertently. Never cover the cooktop with a board, cloth or protective sheet.
- ▶ If the cooktop is turned on or accidentally turned on or if it is still hot, metal objects on the cooktop can heat up. Other items may melt or catch fire. Damp lids can become attached to the cooktop by suction. Do not store items on the cooktop! Always turn the cooking zones off after use!
- ▶ You could burn yourself on the hot cooktop. Protect your hands with heat-resistant pot holders or gloves when handling hot pots and pans. Do not let them get wet or damp, as this causes heat to transfer through the material more quickly with the risk of scalding or burning yourself.
- ▶ When using an electrical appliance, e.g. a hand mixer, near the cooktop, make sure that the power cable does not come into contact with the hot cooktop. The cable's insulation could become damaged.
- ▶ Grains of salt, sugar and sand (e.g. from cleaning vegetables) can cause scratches if they get under pan bases. Make sure that the ceramic surface is clean before placing pans on it.
- ▶ Even a light object can cause damage to the ceramic cooktop in certain circumstances. Do not drop anything on the ceramic surface.

IMPORTANT SAFETY INSTRUCTIONS

- ▶ Do not place hot pans on the sensor buttons and display as this could cause damage to the electronics underneath. Do not place hot pans on the area around the display.
- ▶ Do not allow solid or liquid sugar, or pieces of plastic or aluminum foil to get onto the cooktop when it is hot, as they can damage the ceramic surface when it cools down. If this should occur, turn off the appliance immediately and scrape off all the sugar, plastic or aluminum residues while still hot, using a shielded scraper blade. Use pot holders. Allow the ceramic surface to cool down before cleaning with a suitable ceramic cleaning agent.
- ▶ Pans that boil dry can cause damage to the ceramic glass. Do not leave the appliance unattended while it is being used.
- ▶ Pots and pans with bases with pronounced edges or ridges can scratch the ceramic surface. Only use pots and pans with smooth bases.
- ▶ Lift pans into position on the cooktop. Sliding them into place can cause scuffs and scratches.
- ▶ Fire hazard! Loose-fitting or hanging garments can catch fire. Be sure to wear appropriately fitting clothing when cooking. Never allow loose clothing or flammable materials to come into contact with the cooking zones while the cooking zones are in use.
- ▶ Cookware made of plastic or aluminum foil will melt at high temperatures. Do not use any plastic or aluminum foil cookware.
- ▶ The cooktop frame or cooktop edges (on cooktops with beveled edges) and the controls can become hot due to the influence of the following factors: operating duration, high power level(s), large cookware, and the number of cooking zones being used.
- ▶ Cookware made from aluminum or with an aluminum base can cause shiny metallic spots. These spots can be removed with ceramic glass or stainless steel cleaner (see “Cleaning and Care”, “Cleaning the ceramic surface”).

IMPORTANT SAFETY INSTRUCTIONS

- ▶ If residue remains on the cooktop for any length of time, it can cook into the cooktop and sometimes it is then not possible to remove it. Remove spills and splatters promptly. Also make sure that the bottom of any cookware is clean, dry, and free of grease before placing it on the cooktop.
- ▶ Do not use the ceramic surface for preparing food. Always use suitable cookware.
- ▶ Wet sponges or clothes can cause burns due to hot steam if they are used to wipe spilled food off a hot cooktop. Some cleansers can emit hazardous vapors if they are applied to a hot surface. Be careful when cleaning the cooktop.
- ▶ If the cooktop is damaged, cleansers or spilled food can penetrate the glass surface and cause a short-circuit. Never cook on a damaged cooktop. Contact an electrician immediately.
- ▶ The cooktop has cooking zones of different sizes. Use cookware with a level base that is large enough for the cooking zone. Cookware that is too small leaves part of the hot cooking zone uncovered, which may cause burns due to touching or ignite clothing. The use of cookware of the right size also makes for better use of the heated areas.
- ▶ Not any cookware of glass, glass ceramic, ceramic, clay or other glass cookware is suitable for use on the cooktop. It can be damaged due to sudden temperature change.
- ▶ If the handles of a pot or pan extend across an adjacent cooking zone, this can cause burns, the ignition of flammable materials and the spilling of food due to inadvertent contact with the cookware. Turn the pot or pan so that the handles point toward the inside and do not extend across an adjacent cooking zone.

IMPORTANT SAFETY INSTRUCTIONS

Cleaning and maintenance

- ▶ Do not use a steam cleaner to clean the cooktop. The steam may reach electrical components and cause a short circuit.
- ▶ Miele will guarantee to supply functional parts for a minimum of 10 years and up to 15 years following the discontinuation of your cooktop.

Caring for the environment

Disposal of the packing material

The cardboard box and packing materials protect the appliance during shipping. They have been designed to be biodegradable and recyclable.

Ensure that any plastic wrappings, bags, etc. are disposed of safely and kept out of the reach of children. Danger of suffocation!

Disposal of your old appliance

Electrical and electronic appliances contain valuable materials. They also contain certain substances, compounds and components which were essential for the proper functioning and safe use of the equipment. Handling these materials improperly by disposing of them in your household waste can be harmful to your health and the environment. Therefore, please do not dispose of your old appliance with regular household waste and follow local regulations on proper disposal.



Consult with local authorities, dealers or Miele in order to dispose of and recycle electrical and electronic appliances. Miele assumes no responsibility for deleting any personal data left on the appliance being disposed. Please ensure that your old appliance is kept away from children until removal. Observe safety requirements for appliances that may tip over or pose an entrapment hazard.

Cooktop

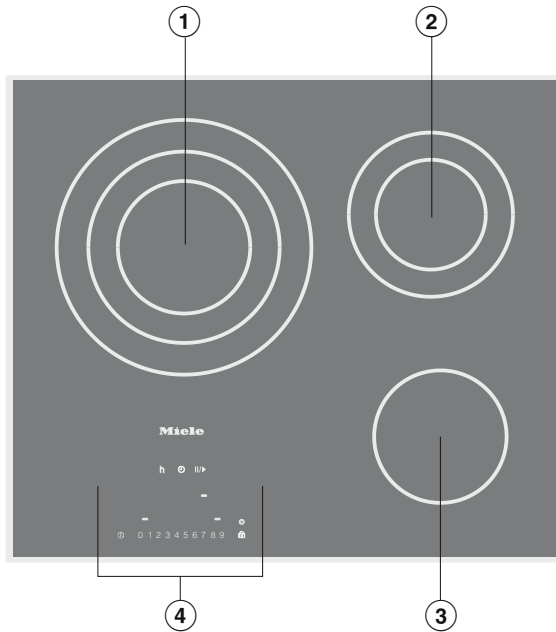

- ① Variable cooking zone
- ② Variable cooking zone
- ③ Standard cooking zone
- ④ Controls and indicators

Overview

Control elements/indicators

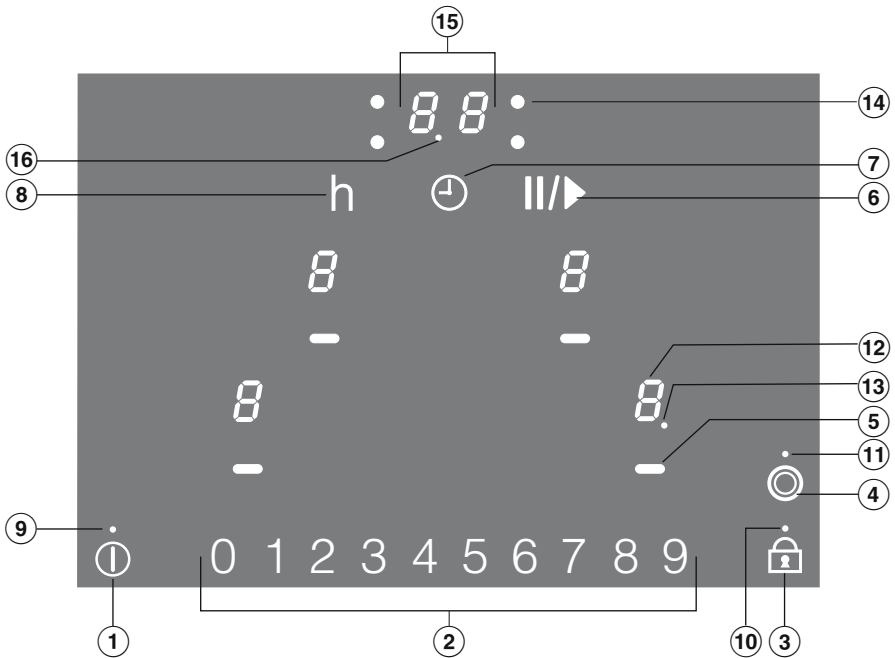

Sensor buttons

- ① Switching the cooktop on and off
- ② Numerical display
 - For setting the power level
 - For setting the timer
- ③ Activating/deactivating the system lock/safety lock
- ④ Additional heating circle
- ⑤ Switching cooking zones on and off
- ⑥ Activating/deactivating the Stop & Go function
- ⑦ Timer
 - For switching on/off
 - For switching between timer functions
 - For selecting a cooking zone (see “witching off a cooking zone automatically”)
- ⑧ Hour function

Indicators

- ⑨ Cooktop switched on
- ⑩ System lock/safety lock activated
- ⑪ Additional heating circle activated

Cooking zone indicator

- ⑫
 - Cooking zone ready for use
 - 1 to 9 Power level
 - ≡ Residual heat
 - R Auto heat-up
- ⑬ Auto heat-up or extended power setting (see “Programming”)

Timer display

- ⑭ For cooking zone selection, e.g., right rear cooking zone
- ⑮
 - 00 to 99 Time in minutes
 - 0.h to 9.h Time in hours
 - LL System lock/safety lock activated
 - dE Demo mode activated
- ⑯ Indicator light for half hours if the timer setting exceeds 99 minutes

Overview

Cooking zone data

Cooking zone	Ø in inch	Ø in cm	Rating in watts for 208/230 V
①	5 ¹¹ / ₁₆ "	14.5	1,100
	8 ¹ / ₄ "	21	2,150
	10 ⁵ / ₈ "	27	3,100
②	4 ³ / ₄ "	12	700
	7 ¹ / ₁₆ "	18	1,800
③	5 ¹¹ / ₁₆ "	14.5	1,200
			Total power: 6,100

Cleaning the cooktop for the first time

- Before first use, wipe down the appliance with a damp cloth and dry it.

Turning on the cooktop for the first time

Metal components are protected by a conditioning agent. Smells and vapor may occur when the appliance is used for the first time.

The smell and any vapors do not indicate a faulty connection or a defective appliance and are not harmful to your health.

How the cooking zones work

Standard cooking zones have one heating element, while variable cooking zones and extended zones have two. Depending on the model, the heating elements may be separated by an insulating ring.

Each cooking zone has overheating protection (a temperature limiter), which stops the ceramic surface from becoming too hot (see “Safety features – Overheating protection”).

When a power level is selected, the heat switches on and the element can be seen through the ceramic surface. The temperature of the cooking zone depends on the power level selected, and is electronically regulated. This controls the “timing” of a cooking zone, switching the element on and off.

Standard cooking zone

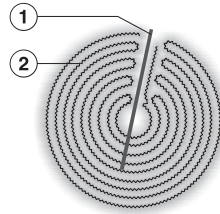

- ① Overheat protection
- ② Heating element

Variable cooking zone

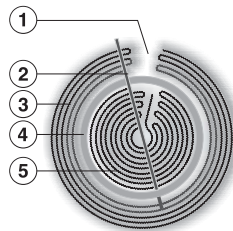

- ① Technical requirement, not a defect
- ② Overheat protection
- ③ Outer heating element
- ④ Insulating ring
- ⑤ Inner heating element

The most suitable cookware is metal pots and pans with thick bottoms that, when cold, bulge inwards slightly. On warming, the bottom extends and sits level on the cooking zone; this conducts the heat optimally.

- Please note that the maximum diameter quoted by manufacturers often refers to the diameter of the top rim of the pot or pan. The diameter of the base (generally smaller) is more important.

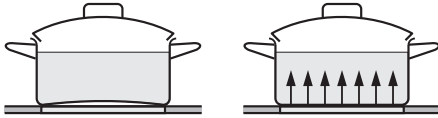

Cold

Hot

Glass, ceramic or stoneware cookware is **less suitable**. These materials do not conduct the heat well.

Pots and pans made of synthetic material or aluminum foil **are not suitable**. These melt at high temperatures.

Cookware made from aluminum or with an aluminum base can cause shiny metallic spots. These spots can be removed with ceramic and stainless-steel cooktop cleaner (see “Cleaning and care”, “Cleaning the ceramic surface”).

The composition of the pan bottom can affect the evenness of the cooking results (e.g., when making pancakes).

- To make optimum use of the cooking zones, choose cookware with a suitable base diameter (see “Overview - Cooking zone data”).
- Use only pots and pans with smooth bases. Rough bases can scratch the ceramic glass.
- Always lift the cookware to move it. This will help prevent scratching.

Energy saving tips

- Ensure that the bottoms of pots or pans match the size of the cooking zone or are somewhat larger. This ensures that heat is not lost unnecessarily.
- Use a lid whenever possible to minimize heat loss.
- For small quantities, select a small pan. A small pan on a small cooking zone uses less energy than a large, only partially filled pan on a large cooking zone.
- Cook with as little water as possible.
- Once food has come to the boil or the pan is hot for frying, reduce the heat to a lower power setting.
- When cooking for a long time, turn the cooking zone off at least 5 or 10 minutes before the end of the cooking time. This makes use of the residual heat.

Setting range

The cooktop is programmed with 9 power levels at the factory. If you wish to fine-tune a setting, you can extend the power-level range to 17 power levels (see “Programming”).

	Setting ranges	
	Factory setting (9 power levels)	Extended setting (17 power levels)
Melting butter, chocolate, etc. Dissolving gelatin Preparing yogurt	1–2	1–2.
Thickening sauces containing only egg yolk and butter Warming small quantities of liquid Keeping food warm that sticks easily Cooking rice	1–3	1–3.
Warming liquid and semi-solid foods Thickening sauces, e.g. Hollandaise Making oatmeal Preparing omelettes, lightly fried eggs Steaming fruit	2–4	2–4.
Defrosting deep-frozen food Steaming vegetables, fish Cooking pasta, pulses Cooking broths, pulse soups	3–5	3–5.
Bringing to the boil and continued cooking of large quantities of food	5	5.
Gently frying (without overheating the fat) of fish, cutlets, sausage, fried eggs, etc.	6–7	6–7.
Cooking potato fritters, pancakes, etc.	7–8	7–8.
Boiling large quantities of water Bringing to a boil	8–9	8.–9

These levels should only be taken as a guide. They apply to 4 normal servings. With deep pans, large quantities, or when cooking without the lid, a higher level is required. For smaller quantities, select a lower level.

Operation

Basic operation

The ceramic cooktop is equipped with electronic sensor buttons that react to finger contact. During activation, the On/Off  sensor button must be pressed somewhat longer than the other buttons for safety reasons. Each reaction of the buttons is acknowledged with an acoustic signal.

The cooking zones and the timer have to be “active” when you want to set or adjust a power level or the duration. To activate the zone or the timer, tap the selection button of the corresponding zone or the timer. After the selection button is tapped, the corresponding zone or timer indicator light will flash. While the indicator light is flashing, set or adjust the power level or the duration.

Exception: If there is only one cooking zone in operation, you can set or adjust the power level without activating it first.

 Malfunction can occur due to dirty and/or covered sensor controls. If the sensor controls are dirty or covered this could cause them to fail to react, to activate a function, or even to switch the cooktop off automatically (see “Safety features – Safety shut-off”). Placing hot cookware on the sensor controls/indicators can damage the electronic underneath.

Keep the sensor controls and indicators clean.

Do not place anything over the sensor controls or indicators.

Do not place hot cookware over the sensor controls or indicators.

 Fire hazard due to overheated food.
Unattended food can overheat and ignite.
Do not leave the cooktop unattended whilst it is being used.

Switching the cooktop on

- Touch the  sensor button.

- appears in each of the cooking zone indicators. If no further entry is made, the cooktop will turn itself off after a few seconds for safety reasons.

Switching the cooking zone on, setting/changing the power level

- Briefly touch the - sensor for the required cooking zone.

 or the selected power level will flash in the cooking zone indicator.

- Touch the appropriate sensor button for the power level you want on the numerical display.

The power level selected will flash for a few seconds and then light up constantly.

Switching off

- To switch a cooking zone off, touch the - sensor button for that cooking zone twice.
- To switch off the cooktop and all the cooking zones, touch the  sensor button.

Residual-heat indicator

If a cooking zone is hot, the residual-heat indicator will light up after it has been switched off or if it is not in use.

The bars in the residual-heat indicator go out one by one as the cooking zone cool down. The last horizontal bar only goes out when the cooking zone is safe to touch.

The residual heat indicators will flash if there is a power cut during use or while residual heat is still present or if you have opened the programming function while residual heat is still present.

 Risk of burning or scalding due to hot cooking zones.

The cooking zones will be hot after use.

Do not touch the cooking zones while the residual heat indicators are on.

Setting the power level – extended power level range

- Touch the numerical keybank between two number sensors.

The power level selected will flash for a few seconds and then light up constantly. The intermediate setting will be represented by an illuminated dot next to the number.

Operation

Extension

You can switch on the second or third heating circles of a cooking zone if available (see “Overview – Cooktop”).

The selected power level will flash in the cooking zone indicator and the indicator light for the additional heating circle will light up. There is no difference in the display between the second and third heating circles of a triple-circle cooking zone.

Switching additional heating circles on

- Switch on the required cooking zone.
- Set the power level you want.

The selected power level will flash in the cooking zone indicator.

■ **Double-circle cooking zone:** touch the  sensor button while the power level is flashing.

■ **Triple-circle cooking zone:** touch the  sensor button while the power level is flashing

- Once: the first heating circle is turned on
- Twice: the third heating circle is turned on

Switching the heating circle off

- Briefly touch the  sensor for the required cooking zone.

The selected power level will flash in the cooking zone indicator and the indicator light for the additional heating circle will light up.

- Touch the  sensor repeatedly until the indicator light for the additional heating circle goes out.

Auto Heat-up

When Auto Heat-up has been activated, the cooking zone turns on automatically at the highest level and then switches to the previously selected continued cooking level. The heat-up time depends on which continued cooking level has been chosen (see chart).

Turning on

- Briefly tap the selection button for the desired cooking zone.
- Tap the sensor button of the desired continued cooking level until a signal sounds and the indicator light in the cooking zone indicator to the right of the continued cooking level lights up.

During the Auto Heat-up time (see table), the indicator light next to the set continued cooking level lights up. With extended power levels (see “Programming”), *P* alternately flashes in the cooking zone display with the set continued cooking level.

When you change the continued cooking level, you deactivate Auto Heat-up.

Deactivating

- Briefly tap the selection button for the desired cooking zone.
- Tap the selected continued cooking level until the indicator light or *P* goes out.

or

- Select a different power level.

Continued cooking level*	Heat-up time [min:sec]
1	1:20
1.	2:00
2	2:45
2.	3:25
3	4:05
3.	4:45
4	5:30
4.	6:10
5	6:50
5.	7:10
6	1:20
6.	2:00
7	2:45
7.	2:45
8	2:45
8.	2:45
9	—

* The continued cooking settings with a dot after the number are only available if the power-level range has been extended (see “Programming”). As the higher continued cooking settings are generally used for frying food, only a relatively short heat-up time is needed to heat up the cookware initially.

Timer

The cooktop has to be turned on if you wish to use the timer. You can set a time between 1 minute (01) and 9 hours (9.h).

The timer can be used for two different functions:

- For setting the timer
- For turning off a cooking zone automatically.

A time up to 99 minutes is set and displayed in minutes.



In case of a time of more than 99 minutes, the timer must be switched to hours (h). The time is set in half-hour steps. Half-hours are indicated by a dot following the number, for example, 2 h 30 min:

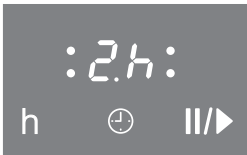

Timer

Setting the minutes

Example: You want to set a time of 15 minutes.

- Make sure the cooktop is switched on.
- Touch the ⊕ sensor button.

00 appears in the timer display, and the right 0 flashes.

First the tens digit is set, then the ones digit.

- Touch the number sensor which corresponds to the tens position (1 in this case).

The timer display will change and 1 will start flashing on the right.

- Touch the number sensor which corresponds to the ones position (5 in this case).

The timer display will change. 1 jumps to the left and 5 appears on the right.



After a few seconds, the timer display will light up continuously. The timer starts counting down.

Setting the hours

To set full hours, touch the respective sensor on the number scale. To set half hours, touch the space between 2 sensors on the number scale.

Example: You want to set a time of 2 hours and 30 minutes.

- Make sure the cooktop is switched on.
- Touch the  sensor button.

 appears in the timer display, and the right  flashes.



- Touch the *h* sensor to set the display to hours.
- Tap the number scale between the *2* and *3* sensor buttons.

After a few seconds, the timer display will light up continuously. The timer starts counting down.

Changing the timer

- Tap the  sensor button.
- Set a new time, as described above.

Deleting the timer

- Touch the  sensor button until  appears in the timer display.

Timer

Switching off a cooking zone automatically

You can set a time after which the cooking zone will switch off automatically. This function can be used on all cooking zones at the same time.

If the programmed time is longer than the maximum time allowed, the safety shut-off function will turn off the cooking zone automatically when the maximum time has elapsed (see “Safety shut-off”).

- Select a power level for the cooking zone you require.
- Keep touching the ⌚ sensor control until the indicator light for this cooking zone starts flashing.

If several cooking zones are on, the indicator lights flash in a clockwise direction, starting with the front left.

- Set the required time.

- If you want to set another cooking zone to switch off automatically, follow the same steps as described above.



If more than one switch-off time is programmed, the shortest time left will be displayed, and the corresponding indicator light will flash. The other indicator lights will light up constantly.

- If you want to show the time left for another cooking zone which is counting down in the background, touch the ⌚ sensor control repeatedly until the indicator light for the cooking zone you require flashes.

Using both timer functions at the same time

The minute minder and automatic switch-off functions can be used at the same time.

If you have programmed one or more switch-off times, and would like to use the minute minder as well:

- Touch the  sensor control repeatedly until the indicator lights of the programmed cooking zones light up constantly and  appears in the timer display.
- Set the time as described above.

If you have set the minute minder and would like to program one or more switch-off times as well:

- Touch the  sensor control repeatedly until the indicator light for the cooking zone you require flashes.
- Set the time as described above.

Shortly after the last entry, the timer display switches to the function with the shortest time left.

If you want to show the times left which are counting down in the background:

- Touch the  sensor control repeatedly until
 - the indicator light for the required cooking zone flashes (automatic switch-off).
 - the timer display (minute minder) starts flashing.

Starting with the shortest time left which is shown in the display, all switched-on cooking zones and the minute minder are shown in a clockwise direction.

Additional functions

Stop & Go

When Stop & Go is activated, the power level of all cooking zones in use is reduced to power level 1.

The cooktop power levels and the timer settings cannot be altered; the cooktop can only be switched off. A set timer will continue to count down. AutoBoost and automatic shut-off times set will be paused.

When Stop & Go is deactivated, the cooking zones will operate at the previously set power level, and the AutoBoost and automatic shut-off times will start to count again.

If the function is not deactivated within 1 hour, the cooktop will switch off.

Activation/deactivation

- Touch the **II/▶** sensor button.

Use this function when the sensors need to be cleaned quickly.

System lock/Safety lock

The system lock and safety lock are deactivated if there is a power outage.

One-finger control is the default setting. You can change the default to three-finger control (see “Programming”).

Your cooktop is equipped with a system lock and a safety lock to prevent the cooktop and the cooking zones being switched on or any settings being altered unintentionally.

The **system lock** is activated when the cooktop is switched off. If the system lock is activated, the cooktop cannot be switched on and the timer cannot be used. The cooktop is programmed so that the system lock must be activated manually. It can be programmed to be activated automatically 5 minutes after the cooktop has been switched off if it is not manually locked first (see “Programming”).

The **safety lock** is activated while the cooktop is switched on. When the safety lock is activated, the cooktop can be operated only under certain conditions:

- The power levels for the cooking zones and the timer settings cannot be changed.
- The cooking zones, entire cooktop, and the timer can be turned off, but once turned off cannot be turned on again.

If a locked sensor is touched when the safety lock or the system lock is activated, the indicator light comes on and LL appears in the timer display for a few seconds.

Activating

- Touch the  sensor until LL appears in the timer display and the safety lock indicator light appears.

After a few moments, the indicator light and LL switch off.

Deactivating

- Touch the  sensor until LL goes out in the timer display and the safety lock indicator light goes out.

Safety features

Safety shut-off

Excessive operating time

The safety shut-off mechanism is triggered automatically if a cooking zone is heated for an unusually long period of time. This time depends on the power level selected. If the time has been exceeded, the cooking zone turns off and the residual-heat indicator appears. If you turn the cooking zone off and on again, it will be ready for operation again.

Safety shut-off if the sensors are covered

Your cooktop will turn off automatically if one or several of the sensors remain covered for longer than 10 seconds, for example, by finger contact, food boiling over or by an object such as an oven glove or tea towel. *F* flashes in the timer display and a buzzer sounds every 30 seconds for 10 minutes.

When you remove the objects or soiling, *F* goes out, the buzzer goes off, and the cooktop is ready for operation again.

Overheating protection

Each cooking zone is equipped with overheating protection (internal temperature limiter). This switches off the cooking zone heating element automatically before it overheats. As soon as the cooking zone temperature has cooled sufficiently, heating is switched on again automatically.

The overheating protection may be activated under the following circumstances:

- No cookware is present on the activated cooking zone.
- The cookware being heated is empty.
- The base of the cookware is not sitting evenly on the cooking zone.
- The cookware is not conducting heat properly.

You can tell that the overheating protection has activated because the heating element switches on and off even when the highest power level is selected.

Cleaning and care

 Risk of burning or scalding due to hot cooking zones.

The cooking zones will be hot after use.

Turn off the cooktop.

Allow the cooktop to cool down before cleaning.

 Risk of damage due to moisture ingress.

The steam from a steam cleaning appliance could reach live electrical components and cause a short circuit.

Do not use a steam cleaner to clean the cooktop.

All surfaces could be discolored or damaged if unsuitable cleaning agents are used. All surfaces are susceptible to scratching.

Remove all cleaning agent residues immediately.

Do not clean with any abrasive or sharp pointed objects.

- Clean the cooktop after every use.
- Dry the cooktop thoroughly after every cleaning to avoid limescale residue.

Unsuitable cleaning agents

To avoid damaging the surfaces of the appliance, do not use:

- liquid dish soap
- cleaning agents containing soda, alkalis, ammonia, acids, or chlorides
- cleaning agents containing limescale remover
- stain or rust removers
- abrasive cleaning agents, such as scouring powder, scouring liquid, or pumice stones
- cleaning agents containing solvents
- dishwasher cleaning agents
- grill and oven sprays
- glass cleaners
- hard, abrasive brushes or sponges (e.g., pot scourers), or sponges which have been previously used and still contain abrasive cleaning agents
- eraser sponges

Cleaning the ceramic surface

 Risk of damage caused by pointed objects.

The seal between the cooktop and the countertop could be damaged. The seal between the ceramic surface and the frame could be damaged.

Do not use pointed objects for cleaning.

When cleaning with liquid dish soap, not all contaminants and residues are removed. An invisible film forms, which causes discoloration of the ceramic. This discoloration cannot be removed.

Clean the ceramic surface regularly with a suitable ceramic cooktop cleaning agent.

- First wipe down the surface with a damp cloth to loosen soiling, then remove stubborn crusting with a glass scraper.
- Then clean the ceramic surface with the Miele Ceramic and Stainless-Steel Cooktop Cleaner (see “Optional accessories – Cleaning and care products”) or with a proprietary ceramic cleaner applied with a paper towel or a clean cloth. Do not put the cleaner on a hot cooktop since this may cause spotting. Please follow the cleaning-agent manufacturer’s instructions.
- Finally wipe the cooktop with a damp cloth and dry it with a soft, dry cloth.

Residues can burn onto the cooktop the next time it is used and cause damage to the ceramic surface. Ensure that all cleaner residues are removed.

- **Spots** caused by limescale, water, and aluminum residues (spots with a metallic appearance) can be removed using the Miele Ceramic and Stainless-Steel Cooktop Cleaner.

 Risk of burning or scalding due to hot cooking zones.

The cooking zones are hot during use.

Wear pot holders and use a glass scraper to remove sugar, plastic, or aluminum foil residues from the hot cooktop.

- Should any **sugar, plastic, or aluminum foil** spill or fall onto a hot cooking zones while it is in use, first turn off the cooktop.
- Then carefully scrape off these residues **immediately** while they are still hot, using a shielded scraper blade.
- Afterwards, clean the ceramic surface in its cooled state, as described above.

Programming

You can adapt the programming of the cooktop to your personal needs. Several settings can be changed in succession.

After the programming function is started, *P* (program) and *S* (status) will appear in the timer display. With cooktops that have 3 cooking zones, an additional display appears at the back left.

The program is displayed in the front left and back left cooking zone displays.

Example:

Program 03 =

Front left 0, rear left 3

Program 14 =

Front left 1, rear left 4

The status is shown in the front right cooking zone display.

After the programming function is exited, an automatic reset is performed. It is concluded when an indicator light lights up briefly via the ① sensor button.

Do not turn on the cooking zone until the reset is concluded.

Starting the programming function

- When the **cooking zone is turned off**, tap the ① and ② sensor buttons simultaneously until the indicator light for the safety lock flashes.

Setting a program

- To set the **ones**, touch the sensor for the **back left** cooking zone followed by the respective number on the settings bar.
- To set the **tens**, touch the sensor for the **front left** cooking zone followed by the respective number on the settings bar.

Setting the status

- Touch the sensor for the **front right** cooking zone followed by the respective number on the settings bar.



Saving the settings

- Touch the ① sensor until the indicators go out.

How to avoid saving the settings

- Touch the ② sensor until the indicators go out.

Programming

Program ¹		Status ²	Settings
P00	Demo mode and factory default settings	S0	Demo mode on ³
		S1	Demo mode off
		S9	Factory default settings reinstated
P02	Number of power levels	S0	9 power levels
		S1	17 power levels ⁴
P04	Tone when a sensor button is touched	S0	Off ⁵
		S1	Quiet
		S2	Medium
		S3	Loud
P05	Audible signal for timer	S0	Off
		S1	Quiet
		S2	Medium
		S3	Loud
P06	System lock/Safety lock	S0	One-finger control with 
		S1	Three-finger control by touching  and the sensors for selecting the right-hand cooking zones at the same time
P07	System lock	S0	System lock can only be activated manually
		S1	Manual and automatic activation of the system lock
P08	Auto heat-up	S0	Off
		S1	On
P11	Second circle of the front left cooking zone	S0	Not switched on at the same time
		S1	Always switches on at the same time
P12	Second circle of the front right cooking zone	S0	Not switched on at the same time
		S1	Always switches on at the same time
P13	Second circle of the rear right cooking zone	S0	Not switched on at the same time
		S1	Always switches on at the same time

Programming

Program ¹		Status ²	Settings
P14	Second circle of the rear central cooking zone	S0	Not switched on at the same time
		S1	Always switches on at the same time
P15	Audible signal if the sensors are covered	S0	Off
		S1	On
P16	Sensor buttons reaction speed	S0	Slow
		S1	Normal
		S2	Fast

¹ Programs not shown here have no allocation.

² The factory setting is shown in bold.

³ After switching the cooktop on, *dE* appears in the timer display for several seconds.

⁴ The intermediate levels are shown on the cooking zone indicator with a dot after the power level. Display of the AutoBoost through the flashing of the continued cooking level alternating with *R*.

⁵ The keypad tone for the On/Off sensor ① cannot be switched off.

Frequently Asked Questions

With the help of the following guide minor faults in the performance of the machine, some of which may result from incorrect operation, can be remedied without contacting the Service Department.

This guide may help you to find the reason for the fault, and how to correct it.

Problem	Possible cause and solution
<p>Cooktop or cooking zones cannot be turned on.</p>	<p>There is no power to the cooktop.</p> <ul style="list-style-type: none"> ■ Check if the breaker has tripped. Contact a qualified electrician or Miele Customer Service (for the minimum fuse rating, see data plate). <p>There may be a technical fault.</p> <ul style="list-style-type: none"> ■ Disconnect the cooktop from the electricity supply for approx. 1 minute by <ul style="list-style-type: none"> – tripping the relevant breaker or screwing the fuse out completely, or – switching off the residual current device. ■ If the cooktop will still not turn on after resetting the breaker or the residual current device, contact a qualified electrician or Miele Customer Service.
<p>There is a strange smell or vapors when the appliance is being used for the first time.</p>	<p>Metal components are protected by a conditioning agent. Smells and vapor may occur when the appliance is used for the first time. The smell and any vapors do not indicate a faulty connection or a defective appliance and are not harmful to your health.</p>
<p>After the cooktop has been switched on, <i>LL</i> appears in the timer display for a few seconds.</p>	<p>The system lock or safety lock is activated.</p> <ul style="list-style-type: none"> ■ Deactivate the system lock or safety lock (see “Safety features – System lock/Safety lock”).
<p><i>F</i> flashes in the timer display and the cooktop switches off automatically.</p>	<p>One or more of the sensor controls are covered, e.g., by finger contact, food boiling over, or an object.</p> <ul style="list-style-type: none"> ■ Clean off any dirt and/or remove the object (see “Safety features – Safety shut-off”).
<p>After turning on the cooktop, <i>dE</i> appears in the timer display for several seconds. The cooking zones don't heat up.</p>	<p>The cooktop is in demo mode.</p> <ul style="list-style-type: none"> ■ Deactivate demo mode (see “Programming”).

Frequently Asked Questions

Problem	Possible cause and solution
A cooking zone turns itself off automatically.	<p>It might have been turned on for too long.</p> <ul style="list-style-type: none"> ■ You can use the cooking zone again by turning it back on (see “Safety features – Safety shut-off”).
Auto Heat-up is turned on, but the food does not start cooking.	<p>Large amounts of food are being heated.</p> <ul style="list-style-type: none"> ■ Start cooking at the highest power level, then reduce the power level manually.
	<p>The pan is not conducting heat properly.</p> <ul style="list-style-type: none"> ■ Use a different pan that is able to better conduct heat on an induction cooktop.
The food in the pan is barely heating up or is not heating up at all.	<p>The pan is not conducting heat properly.</p> <ul style="list-style-type: none"> ■ Use a different pan that is able to better conduct heat.
	<p>The pan is too large for the cooking zone.</p> <ul style="list-style-type: none"> ■ Use a smaller pan.
	<p>The outer ring of a variable or extended cooking zone is not switched on.</p> <ul style="list-style-type: none"> ■ Switch the outer ring on.
The heating element for one of the cooking zones switches on and off.	<p>This “timing” of the element is normal. It is caused by the electronic temperature control (see “How the cooking zones work”).</p> <p>If the heating switches on and off at the highest power level, the overheating protection has been triggered (see “Safety features – Overheating protection”).</p>
One or more residual heat indicators is flashing.	<p>There was a power failure during operation or when residual heat was present.</p> <p>You called the programming function while residual heat was still present.</p>

Frequently Asked Questions

Problem	Possible cause and solution
The sensor buttons are over-sensitive or do not react at all.	<p>The sensitivity level of the sensor buttons has changed.</p> <ul style="list-style-type: none">■ Ensure that the cooktop is not in direct sunlight or strong artificial light and that the area around the cooktop is not too dark.■ Make sure that there is nothing covering the sensor buttons or the cooktop. Take any pans off the cooktop and wipe away any food deposits.■ Interrupt the power supply to the cooktop for approx. 1 minute.■ If the problem persists after power is restored, please contact Miele Service.
In the timer display <i>FE</i> flashes alternately with numbers.	<p>There is an electronic fault.</p> <ul style="list-style-type: none">■ Disconnect the power supply to the cooktop for approx. 1 minute.■ If the problem persists after power has been restored, please contact Customer Service.

Optional accessories

Miele offers a range of useful accessories, as well as cleaning and conditioning products for your appliance.

These products can be easily ordered from the Miele webshop.

These products can also be ordered from Miele Technical Service (see the end of these operating instructions) or your Miele dealer.

Stainless steel conditioner **250 ml**



Removes heavy soiling, lime scale, and aluminum residue.

Contact in the event of a fault

In the event of a fault which you cannot remedy yourself, please contact your Miele dealer or Miele Customer Service.

You can book a Miele Service Call online at www.miele.com/service.

Contact information for Miele Customer Service can be found at the end of this document.

Please quote the model identifier and serial number of your appliance (SN) when contacting Miele Customer Service. Both pieces of information can be found on the data plate.

Appliance warranty and product registration

You can register your product and/or view the manufacturer's warranty terms and conditions for Miele appliances and vacuum cleaners at www.mieleusa.com.

Installation

IMPORTANT SAFETY INSTRUCTIONS - INSTALLATION

 Risk of damage caused by incorrect installation.
Incorrect installation can damage the cooktop.
The cooktop must only be installed by a qualified specialist.

 Risk of electric shock from voltage.
Incorrect connection to the power supply may result in an electric shock.
The cooktop must be connected to the electrical supply by a qualified person only.

 Damage from falling objects.
Take care not to damage the cooktop when installing cabinetry or a ventilation hood above it.
Install the cabinetry and ventilation hood before installing the cooktop.

- ▶ Reaching over a hot cooktop to access the cabinets can result in burns. You can reduce the risk of burns by installing a ventilation hood that extends at least 4 ¾" (12 cm) past the bottom of the cabinets. Do not install any cabinets above the cooktop.
- ▶ The countertop must be heat-resistant (up to 212°F / 100°C), so that it does not become deformed or the veneer detached. The wall strips must be heat-resistant as well.
- ▶ The cooktop must not be installed above refrigerators/freezers, dishwashers, or washer/dryers.
- ▶ When installing the cooktop, make sure that the power cord cannot come into contact with hot appliance parts.
- ▶ Ensure that the power cord cannot be touched after the cooktop has been installed.
- ▶ After the installation of the cooktop, the electrical cord may not come into contact with any moving kitchen parts (e.g. a drawer) or be subject to mechanical stress.
- ▶ Observe carefully the safety clearances listed on the following pages.

Safety distances

Safety clearance above the cooktop

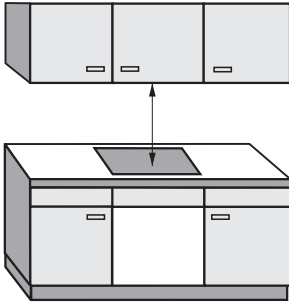

For a ventilation hood above the cooktop, always use the clearance specified by the hood manufacturer. If there are no specifications from the hood manufacturer or if flammable materials (e.g. a utensil rail) are installed above the cooktop, the clearance must be at least 30" (760 mm).

If there is more than one appliance installed below the ventilation hood, each with a different safety clearance, the largest clearance must be used.

Installation

Safety clearances to the sides and back of the cooktop

Ideally the cooktop should be installed with plenty of space on either side.

The minimum distance ① shown below must be maintained between the back of the cooktop and a tall unit or wall.

The minimum distance ②, ③ shown below must be maintained between a tall unit or a wall to the left or right of the cooktop with a minimum distance of 11 3/4" (300 mm) on the opposite side.

① minimum distance between the **back** of the counter cut-out and the rear edge of the counter:
2" (50 mm)

② minimum distance to the **right** of the counter cut-out to the closest adjacent piece of cabinetry (for instance, a high cabinet) or a room wall:
2" (50 mm)

③ minimum distance to the **left** of the counter cut-out to the closest adjacent piece of cabinetry (for instance, a high cabinet) or a room wall:
4" (100 mm)

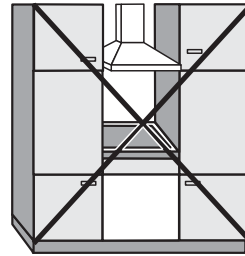

Not allowed

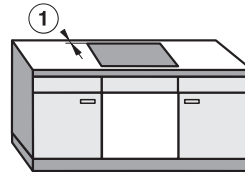
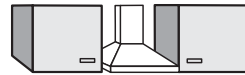

Highly recommended

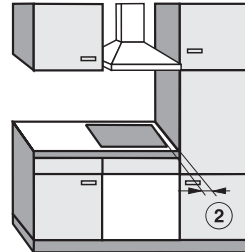

Not recommended

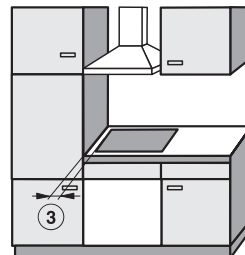

Not recommended

Protective base

Installation of a protective base under the cooktop is allowed but not required.

If an interim shelf is fitted under the cooktop, there must be a minimum gap of $4\frac{5}{16}$ " (110 mm) between the top of the countertop and the top of the shelf.

Leave a gap of $5/16$ " (10 mm) at the back of the shelf to accommodate the cable. If the cooktop has an external power connection box, the minimum gap is $1\frac{3}{8}$ " (35 mm).

Installation

Safety distance from the wall covering

If a wall covering is installed, a minimum safety distance must be maintained between the countertop cut-out and the covering, since high temperatures can damage these materials.

If the covering is made of a combustible material (such as wood), the distance between the countertop cut-out and the wall covering must be a minimum of 2" (50 mm).

For coverings made of non-combustible materials (such as metal, marble, granite, ceramic tiles) the minimum safety distance between the countertop cut-out and the wall covering must be 2" (50 mm) minus the thickness of the covering. For example: thickness of wall covering 2" (50 mm) - $\frac{9}{16}$ " (15 mm) = minimum safety distance $1\frac{7}{16}$ " (35 mm).

Flush-mounted cooktops

Framed cooktops

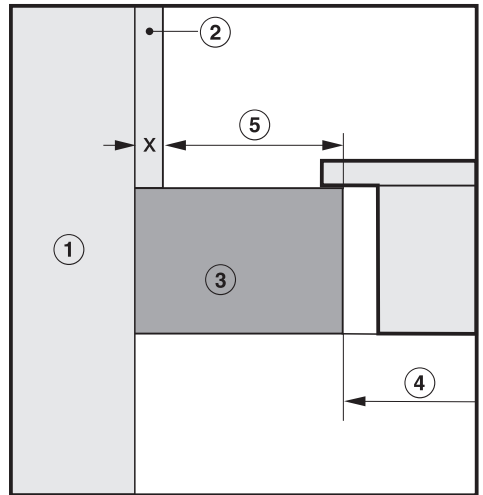
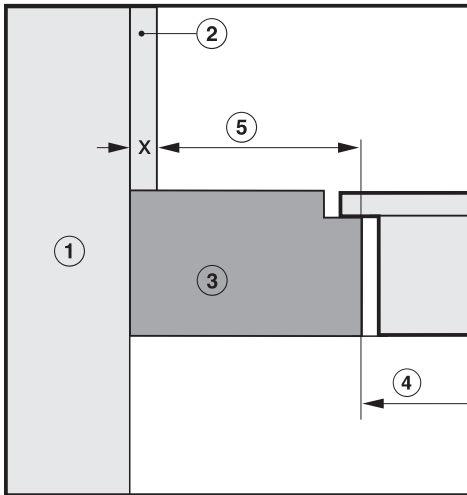

- ① Wall frame
- ② Wall covering dimension x = thickness of the niche cladding
- ③ Countertop
- ④ Countertop cut-out
- ⑤ Minimum distance for
flammable materials 2" (50 mm).
non-flammable materials 2" (50 mm) - dimension x

Installation notes

Seal between cooktop and countertop

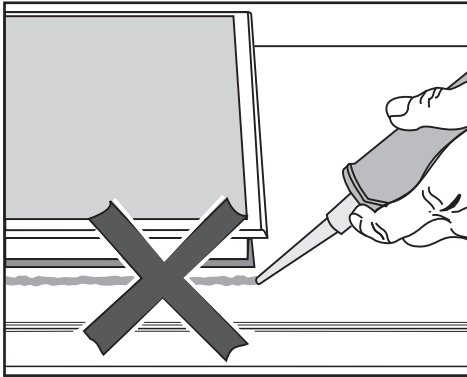

⚠ Damage caused by incorrect installation.

Using sealant under the cooktop could result in damage to the cooktop and the countertop if the cooktop ever needs to be removed for servicing.

Do not use sealant between the cooktop and the countertop.

The sealing strip under the edge of the cooktop provides a sufficient seal for the countertop.

Sealing strip

Dismantling the cooktop for service purposes may damage the sealing strip underneath the edge of the cooktop.

Always replace the sealing strip before reinstalling the cooktop.

Tiled countertop

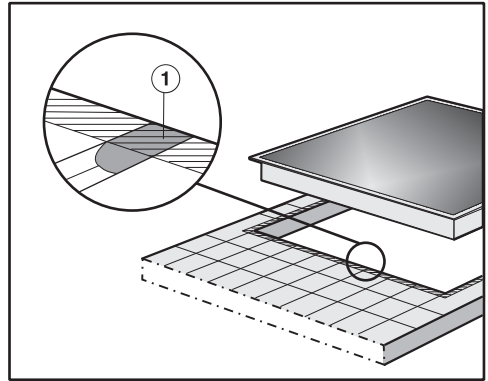

Grout lines ① and the shaded area under the cooktop frame must be smooth and even. If they are not, the cooktop will not sit flush with the countertop and the sealing strip underneath the cooktop will not provide a good seal between the cooktop and the countertop.

Installation

Preparing the countertop

- Create the countertop cut-out. Remember to maintain the minimum safety distances (see “Installation” – “Safety distances”).

Wooden countertops

- Seal any cut surfaces on the wooden countertop with a special varnish, silicone rubber, or resin to prevent the wood from swelling as a result of moisture. The sealant must be temperature-resistant.

Ensure that the sealant does not get on the top surface of the countertop.

The sealing strip ensures that the cooktop will sit securely in the cut-out without slipping. Any gap between the trim and countertop will become smaller over time.

Securing the spring clamps

The exact positioning of the spring clamps is shown in the individual cooktop diagrams.

Wooden countertops

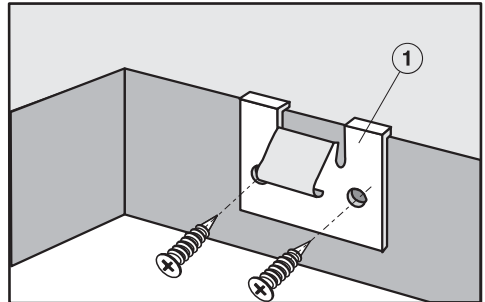

- Position the spring clamps ① on the top edge of the cut-out as shown in the cooktop illustration.
- Fasten the spring clamps ① using the 1 3/8" (3.5 x 1" (25 mm) wood screws supplied with the appliance.

Installation

Granite and marble countertops

You will need heavy-duty double-sided adhesive tape (not included with the cooktop) to fasten the spring clamps.

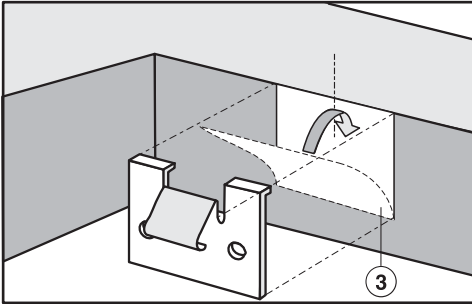

- Attach the adhesive tape ③ along the top edge of the cut-out in the positions shown in the cooktop illustration.
- Position the spring clamps on the top edge of the cut-out and press them firmly into place.

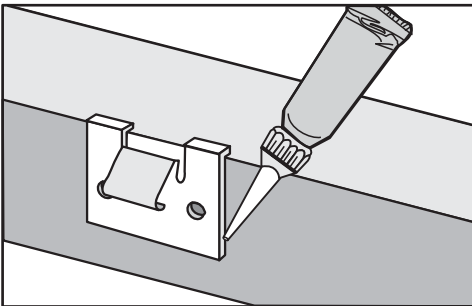

- Coat the side edges and the lower edges of the spring clamps with silicone.

Installing the cooktop

- Feed the appliance power cord down through the counter cut-out.
- Position the cooktop in the counter cut-out.
- Using both hands, press down evenly on the sides of the cooktop until it clicks into position. When doing this make sure that the seal of the appliance sits flush with the countertop on all sides. This is important to ensure an effective seal all round.

If during installation the seal around the frame does not sit flush with the countertop in the corners, the corner radius, maximum 3/16" ($\leq R4/4$ mm), can be carefully filed down to fit.

Do not use any additional sealant (e.g. silicone).

- Connect the cooktop to the electrical power supply.
- Check that the cooktop works.

The cooktop can only be removed using a special tool.

Electrical connection

ATTENTION:

Before installation or servicing, disconnect the power supply by either removing the fuse, shutting off the main power or manually “tripping” the circuit breaker.

Installation work and repairs should only be performed by a qualified technician in accordance with all applicable codes and standards. Repairs and service by unqualified persons could be dangerous and the manufacturer will not be held responsible. Installation, repair, and maintenance work should only be performed by a Miele-authorized service technician. Work by unqualified persons can cause considerable danger to users. Miele cannot be held liable for any damage arising as a result of such work.

Before connecting the appliance to the power supply, make sure that the voltage and frequency listed on the rating label correspond with the household electrical supply. This data must correspond to prevent appliance damage. Consult an electrician if in doubt.

For safety reasons, the cooktop may only be used when it has been fully installed into the countertop.

To guarantee the electrical safety of this appliance, continuity must exist between the appliance and an effective grounding system. It is imperative that this basic safety requirement be met. If there is any doubt, have the electrical system of the house checked by a qualified electrician.

Installation, repair and maintenance work should only be performed by a Miele-authorized qualified electrician in compliance with local regulations and the ANSI National Electrical Code / NFPA 70 in the United States or the Canadian Electric Code, CSA C22.1-02. in Canada.

Installer:

- Please leave these instructions with the customer.

Installation

Connection

- Ensure that the connection data on the data plate (voltage, frequency, and fuse rating) match those of your electrical supply.

The data plate is located underneath the cooktop.

The cooktop is approved and ready for connection to a grounded connector with three connecting wires, sheathed by a flexible metal hose.

It must be connected to an assigned line in an approved connecting socket.

The appliance must be able to be disconnected from the power supply on all poles by disconnecting devices! (When turned off, a contact distance of at least $\frac{1}{8}$ " (3 mm) must be present!) The disconnecting devices are overcurrent protection elements and protective circuit breakers.

Black: Connect to L1 (hot)

Red: Connect to L2 (hot)

Green: Connect to GND (ground)

208/240 V, 60 Hz, 30 A

Make sure that the connecting socket is accessible after the installation of the cooktop.

Further information can be found on the included data plate.



WARNING:
**THIS COOKTOP MUST BE
GROUNDED**

This service is available in USA only.

MieleCare, our Extended Service Contract program, gives you the assurance of knowing that your appliance investment is covered by 5 years of worry free ownership.

MieleCare is the only Extended Service Contract in the industry that guarantees repairs by a Miele Authorized Service Provider using genuine Miele parts. Only genuine Miele parts installed by factory trained professionals can guarantee the safety, reliability, and longevity of your Miele appliance.

Please note that unless expressly approved in writing by Miele's Service department, Extended Service Contracts offered by other providers for Miele products will not be recognized by Miele. Our goal is to prevent unauthorized (and untrained) service personnel from working on your Miele products, possibly doing further damage to them, you and/or your home.

To learn more about **MieleCare** Extended Service Contracts, please contact your appliance dealer or visit us online at:

www.mieleusa.com

**Please have the model and serial number
of your appliance available when
contacting Customer Service.**

U.S.A.

Miele, Inc.

National Headquarters

9 Independence Way
Princeton, NJ 08540

Customer Service & Support

Phone: 888-99-MIELE(64353)
info@mieleusa.com
www.mieleusa.com

International Headquarters

Miele & Cie. KG
Carl-Miele-Straße 29
33332 Gütersloh
Germany

Canada

**Importer
Miele Limited**

Headquarters and Miele Centre

161 Four Valley Drive
Vaughan, ON L4K 4V8
www.miele.ca

Customer Care Centre

Phone: 800-565-6435
905-532-2272
customercare@miele.ca

KM 5820

en-US, CA

M.-Nr. 07 844 700 / 03