



Operating and installation instructions Steam combination oven





It is **essential** to read these operating and installation instructions before installing and using the appliance. This prevents both personal injury and damage to the appliance.





Contents

Warning and Safety instructions	6
Caring for the environment	14
Overview	15
Controls	16
On/Off sensor	17
Display	17
Sensor controls	17
Symbols	19
Operating principles	20
Selecting a menu option	20
Changing a setting in a list	20
Changing the setting with a segment bar	20
Selecting a function	20
Entering numbers	21
Activating MobileStart	21
Drawing in water	22
Features	23
Data plate	23
Items supplied	23
Accessories supplied and available to order	23
Safety features	30
PerfectClean treated surfaces	30
Before using for the first time	31
Miele@home	31
Standard settings	32
Heating up the steam combination oven for the first time and rinsing the steam injection system	33
Settings	34
Settings overview	34
Opening the "Settings" menu	36
Language 	36
Time	36
Lighting	36
Display	37
Volume	37
Units	38
Booster	38
Rapid cooling	38
Keeping warm	38
Recommended temps	39

Cooling fan run-on.....	39
Water hardness.....	40
Altitude.....	42
Safety	42
Miele@home	42
Remote control	43
Activating MobileStart.....	43
RemoteUpdate	43
Software version.....	44
Showroom programme.....	44
Factory default.....	44
Operating hours.....	44
Min. minder	45
Main and sub-menus	47
Energy saving tips	48
Operation	50
Changing values and settings for a cooking programme.....	51
Changing the temperature	51
Setting cooking durations.....	51
Changing the set cooking durations	52
Deleting the set cooking durations	52
Cancelling cooking	52
Interrupting a cooking programme in the Steam cooking function.....	52
Pre-heating the oven.....	53
Booster.....	53
Rapid cooling.....	54
Keeping warm	54
Steam cooking.....	55
Using Steam cooking 	55
Frozen.....	56
Cooking with liquid.....	56
Notes on the cooking charts	56
Shelf level.....	56
Temperature.....	56
Duration	56
Vegetables.....	56
Fish	57
Meat	58
Rice.....	59
Grains.....	59
European dumplings	59

Contents

Fruit	59
Moisture Plus	60
Using Moisture Plus 	60
Automatic programmes	62
Categories	62
Using Automatic programmes.....	62
Usage notes	62
Other applications	63
Defrost	63
Low temperature cooking.....	63
Bottling.....	64
Drying.....	66
Frozen food/Ready meals.....	67
Heat crockery.....	67
Baking	68
Tips on baking	68
Notes on the cooking charts	68
Notes on the oven functions	69
Roasting	70
Tips for roasting.....	70
Notes on the cooking charts	70
Notes on the oven functions	71
Grilling	72
Tips for grilling.....	72
Notes on the cooking charts	72
Notes on the oven functions	73
Fan Grill 	74
Grill 	75
Cleaning and care	76
Unsuitable cleaning agents.....	76
Removing normal soiling	77
Removing stubborn soiling (excluding the FlexiClip telescopic runners).....	77
Stubborn soiling on the FlexiClip telescopic runners.....	78
Cleaning the catalytic enamelled back panel	78
Removing soiling caused by spices, sugar and similar deposits	79
Removing oil and grease soiling	79
Cleaning the oven ceiling	79
Evaporate res. moisture.....	80

Maintenance	81
Soak	81
Drying	82
Descale.....	82
Removing the door	85
Dismantling the door	86
Fitting the door	88
Removing the shelf runners with FlexiClip telescopic runners.....	89
Removing the back panel.....	89
Problem solving guide.....	90
Service.....	95
Contact in case of fault.....	95
Warranty	95
Installation.....	96
Building-in dimensions	96
Installation in a tall or base unit.....	96
Side view.....	97
Connections and ventilation	98
Installing the steam combination oven	99
Electrical connection	100
Cooking charts.....	101
Vegetables 	101
Fish 	102
Meat 	102
European dumplings 	102
Rice 	102
Creamed mixture	103
Rubbed in mixture	104
Yeast dough.....	105
Quark dough.....	106
Sponge mixture.....	106
Choux pastry, puff pastry, meringue	107
Savoury snacks	108
Beef	109
Veal	110
Pork.....	111
Lamb, game	112
Poultry, fish.....	113
Copyright and licences for the communication module	114

Warning and Safety instructions

This steam combination oven complies with all current local and national safety requirements. However, inappropriate use can lead to personal injury and damage to property.

Read the operating and installation instructions carefully before using the steam combination oven. They contain important information on safety, installation, use and maintenance of the appliance. This prevents both personal injury and damage to the steam combination oven.

In accordance with standard IEC 60335-1, Miele expressly and strongly advises that you read and follow the instructions in “Installation”, as well as in the “Warning and Safety instructions”.

Miele cannot be held liable for injury or damage caused by non-compliance with these instructions.

Keep these instructions in a safe place and pass them on to any future owner.

Correct application

- ▶ This steam combination oven is designed for domestic use and for use in similar environments by guests in hotel or motel rooms, bed & breakfasts and other typical living quarters. This does not include common/shared facilities or commercial facilities within hotels, motels or bed & breakfasts.
- ▶ This steam combination oven is not intended for outdoor use.
- ▶ The steam combination oven is intended only to steam, bake, roast, grill, cook, defrost, bottle and dry food. Any other use is not permitted.
- ▶ This steam combination oven is not intended for use by persons with reduced physical, sensory or mental capabilities, or lack of experience and knowledge, unless they are supervised whilst using it. They may only use the steam combination oven unsupervised if they have been shown how to use it in a safe manner. They must be able to recognise and understand the dangers of misuse.
- ▶ The oven compartment is equipped with special lamps to cope with particular conditions (e.g. temperature, moisture, chemical resistance, abrasion resistance and vibration). These special lamps must only be used for the purpose for which they are intended. They are not suitable for room lighting.

Safety with children

- ▶ Activate the system lock to ensure that children cannot switch on the steam combination oven inadvertently.
- ▶ Young children must not be allowed to use this appliance.
- ▶ Older children may only use the steam combination oven if its operation has been clearly explained to them and they are able to use it safely. They must be able to understand and recognise the possible dangers of misuse.
- ▶ Cleaning work may only be carried out by older children under the supervision of an adult.
- ▶ Children should be supervised in the vicinity of the steam combination oven. Never allow children to play with the steam combination oven.
- ▶ Risk of suffocation from packaging material. Whilst playing, children may become entangled in packaging material (such as plastic wrapping) or pull it over their head with the risk of suffocation. Keep packaging material away from children.
- ▶ Risk of injury caused by hot surfaces and steam. Children's skin is far more sensitive to high temperatures than that of adults. External parts of the steam combination oven such as the door glass, control panel and the vent become quite hot. Do not let children touch the steam combination oven when it is in operation. Keep children well away from the steam combination oven until it has cooled down and there is no danger of injury.
- ▶ Risk of injury from the open door. The oven door can support a maximum weight of 15 kg. Children could injure themselves on an open door.
Do not let children sit on the open door, lean against it or swing on it.

Technical safety

- ▶ Unauthorised installation, maintenance and repairs (including removal of any cover) can cause considerable danger for the user. Installation, maintenance and repairs must only be carried out by a Miele authorised technician.
- ▶ Damage to the steam combination oven can compromise your safety. Check the steam combination oven for visible signs of damage. Never use a damaged steam combination oven.

Warning and Safety instructions

- ▶ Temporary or permanent operation with a self-sufficient or non-mains synchronous energy supply system (e.g. isolated networks, back-up systems) is possible. A requirement for the operation is that the energy supply system complies with all current local and national requirements that apply to stand-alone, solar and/or battery systems. The protective measures provided in the installation and in this Miele product must also be assured in their function and operation in isolated operation or in non-mains synchronous operation, or replaced with equivalent measures in the installation.
- ▶ The electrical safety of the steam combination oven can only be guaranteed when continuity is complete between it and an effective earthing system. It is essential that this basic safety requirement is present and tested regularly. If in doubt, the electrical installation should be checked by a qualified electrician.
- ▶ The connection data (voltage and frequency) on the data plate of the steam combination oven must match the mains electricity supply in order to avoid the risk of damage to the steam combination oven. Compare this before connecting the appliance to the mains electricity supply. If in any doubt, consult a qualified electrician.
- ▶ Multi-socket adapters and extension leads do not guarantee the required safety of the appliance (e.g. danger of overheating). Do not use these to connect the steam combination oven to the mains electrical supply.
- ▶ For safety reasons, this steam combination oven must only be used after it has been built in.
- ▶ This steam combination oven must not be installed and operated in mobile installations (e.g. on a ship).
- ▶ Risk of injury due to electric shock. Any contact with live connections or tampering with the electrical or mechanical components of the steam combination oven will endanger your safety and may lead to appliance malfunctions. Do not open the steam combination oven housing under any circumstances.
- ▶ The manufacturer's warranty may be invalidated if the steam combination oven is not repaired by a Miele approved service technician.
- ▶ Miele can only guarantee the safety of the appliance when original Miele spare parts are used. Faulty components must only be replaced by original spare parts.



Warning and Safety instructions

- ▶ If the steam combination oven is delivered without a mains connection cable, a special cable must be installed by a suitably qualified and competent person in order to avoid a hazard (see "Installation - Electrical connection").
- ▶ If the mains connection cable is damaged, it must be replaced with a special connection cable by a suitably qualified and competent person in order to avoid a hazard (see "Installation - Electrical connection").
- ▶ During installation, maintenance and repair work, e.g. if the oven lighting is faulty, the steam combination oven must be completely disconnected from the electricity supply (see "Problem solving guide"). To ensure this:
 - Switch off the mains circuit breaker, or
 - remove the screw-out fuse (in countries where this is applicable),
or
 - switch off at the wall socket and withdraw the plug. To do this, pull the plug and not the mains connection cable.
- ▶ The steam combination oven requires a sufficient supply of cool air for efficient operation. Make sure that the supply of cool air is not hindered in any way (e.g. by heat insulation strips fitted in the housing unit). Furthermore, the required supply of cool air must not be excessively heated by other heat sources (e.g. solid fuel stoves).
- ▶ If the steam combination oven is installed behind a furniture door, do not close the door while the steam combination oven is in operation. Heat and moisture can build up behind a closed furniture door. This can potentially cause damage to the steam combination oven, the furniture unit and the flooring. Leave the furniture door open until the steam combination oven has cooled down completely.



Correct use

- ▶ Risk of injury caused by hot surfaces and steam. The steam combination oven gets hot during operation. You could burn yourself on steam, the heating elements, oven compartment, accessories or food.
Wear oven gloves when placing food in the oven or removing it, and when adjusting oven shelves etc. in a hot oven.

Warning and Safety instructions

- ▶ Risk of injury caused by hot food.
Food may spill or splash around when placing it into the oven or removing it. The food can cause burns.
When placing cooking containers in the oven or removing them, make sure that the hot food does not spill.
- ▶ To avoid fuelling any flames, do not open the door of the steam combination oven if smoke occurs inside the appliance. Interrupt the programme by switching the steam combination oven off and disconnect it from the mains electricity supply. Do not open the door until the smoke has dispersed.
- ▶ Due to the high temperatures radiated, objects left near the steam combination oven could catch fire. Do not use the steam combination oven to heat up the room.
- ▶ Oils and fats can ignite if allowed to overheat. Never leave the steam combination oven unattended when cooking with oil or fats. Never attempt to put out oil or fat fires with water. Switch the steam combination oven off and extinguish the flames by leaving the door closed.
- ▶ Grilling food for excessively long cooking durations can cause it to dry out with the risk of catching fire. Do not exceed the recommended cooking durations.
- ▶ Certain foods dry out quickly and may catch fire due to high grilling temperatures.
Never use a grill function to finish baking bake-off rolls or bread, or to dry flowers or herbs. Instead, use the Fan Plus  or Conventional Heat  function and always ensure this type of procedure is supervised.
- ▶ If using alcohol in your recipes, please be aware that high temperatures can cause the alcohol to vaporise and even to ignite on the hot heating elements.
- ▶ When using residual heat to keep food warm, corrosion from high air humidity and condensation can occur in the steam combination oven. This can also cause damage to the control panel, worktop and surrounding kitchen furniture. Keep the steam combination oven on and select the lowest temperature available for the selected function. The cooling fan will then continue to run and dissipate the moisture.

Warning and Safety instructions

- ▶ Food which is stored in the oven compartment or left in it to be kept warm can dry out and the moisture released can lead to corrosion damage in the steam combination oven. Always cover food that is left in the oven to keep warm.
- ▶ An accumulation of heat can cause the enamel on the floor of the oven to crack or flake off.
Never line the floor of the oven compartment with aluminium foil or oven liners.
If you wish to place crockery on the floor of the oven compartment during cooking, or place crockery on the floor of the oven compartment to heat it up, you can do so, but only with the Fan Plus  or Eco Fan Heat  function without the Booster function.
- ▶ The oven compartment floor can become damaged by items being pushed around on it. When placing pots, pans or crockery on the oven compartment floor, ensure that you avoid pushing them around.
- ▶ Danger of injury caused by steam. Pouring a cold liquid onto a hot surface creates steam, which can cause severe scalding. The sudden temperature change can also cause damage to hot surfaces. Never pour cold liquids directly onto hot surfaces.
- ▶ Danger of injury caused by steam. During cooking processes using steam, moisture injection and during the residual moisture evaporation process, steam is produced which can lead to severe scalding. Never open the door during a cooking process using steam or during the evaporation of residual water.
- ▶ It is important that the temperature in the food being cooked is evenly distributed and sufficiently high. This can be achieved by stirring or turning the food.
- ▶ Plastic dishes that are not suitable for use in an oven will melt and may ignite at high temperatures and damage the steam combination oven.
Use only plastic containers that are suitable for use in an oven. Follow the manufacturer's instructions.
If you wish to use plastic containers for steam cooking, make sure that these are heat-resistant to 100 °C and able to withstand hot steam. Other plastic containers can melt or become fragile and brittle.
- ▶ Preserving and heating food in sealed tins will result in an increase in pressure, which can cause them to explode. Do not use tins for preserving or heating food.

Warning and Safety instructions

- ▶ Risk of injury from the open door. You could bang into the open door or trip over it. Avoid leaving the door open unnecessarily.
- ▶ The door can support a maximum load of 15 kg. Do not lean or sit on an open door, or place heavy items on it. Make sure that nothing gets trapped between the door and the oven compartment. The steam combination oven may get damaged.
- ▶ The steam could reach live electrical components and cause a short circuit. This could also destroy the electrical components. Do not operate the steam combination oven without the lamp cover.

The following applies for stainless steel surfaces:

- ▶ The coated stainless steel surface can be damaged by adhesives and will lose its dirt-repelling properties. Do not use sticky notes, adhesive tape or other types of adhesive on the stainless steel surface.
- ▶ Magnets can cause scratches. Do not use the stainless steel surface as a magnetic notice board.

Cleaning and care

- ▶ Risk of injury due to electric shock. The steam from a steam cleaning appliance could reach electrical components and cause a short circuit. Never use a steam cleaner for cleaning.
- ▶ Scratches on the door glass can cause the glass to break. Do not use abrasive cleaners, hard sponges, brushes or sharp metal tools to clean the door glass.
- ▶ The shelf runners can be removed (see "Cleaning and care – Removing the shelf runners with FlexiClip telescopic runners"). Refit the shelf runners correctly.
- ▶ The catalytic enamelled back panel can be removed for cleaning purposes (see "Cleaning and care – Removing the catalytic enamelled back panel"). Ensure it is correctly fitted after cleaning and never operate the steam combination oven without the back panel fitted.
- ▶ In warm, moist environments, there is a higher probability of vermin infestations (e.g. cockroaches). Ensure the steam combination oven and the area surrounding it are always kept clean. Damage caused by vermin is not covered by the warranty.

Accessories

- ▶ Only use original Miele accessories. If other parts are used, warranty, performance and product liability claims will be invalidated.
- ▶ Miele will guarantee to supply functional spare parts for a minimum of 10 years and up to 15 years following the discontinuation of your steam combination oven.
- ▶ The Miele gourmet oven dish HUB 5000/HUB 5001 (if available) must not be inserted on shelf level 1. This will damage the oven floor. The lack of clearance will create an accumulation of heat which can cause the enamel to crack or flake off. Never place a Miele oven dish on the upper support of shelf level 1 either as it will not be secured by the non-tip safety notches. As a general rule, use shelf level 2.

Caring for the environment

Disposal of the packing material

The transport and protective packaging has been selected from materials which are environmentally friendly for disposal, and can normally be recycled.

Recycling the packaging reduces the use of raw materials in the manufacturing process and also reduces the amount of waste in landfill sites.

Ensure that any plastic wrappings, bags etc. are disposed of safely and kept out of the reach of babies and young children. Danger of suffocation.

Disposing of your old appliance

Electrical and electronic appliances often contain valuable materials. They also contain specific materials, compounds and components, which were essential for their correct function and safety. These could be hazardous to human health and to the environment if disposed of with your domestic waste or if handled incorrectly. Please do not, therefore, dispose of your old appliance with your household waste.



Please dispose of it at your local community waste collection / recycling centre for electrical and electronic appliances. You are also responsible for deleting any personal data that may be stored on the appliance prior to disposal. Please ensure that your old appliance poses no risk to children while being stored prior to disposal.



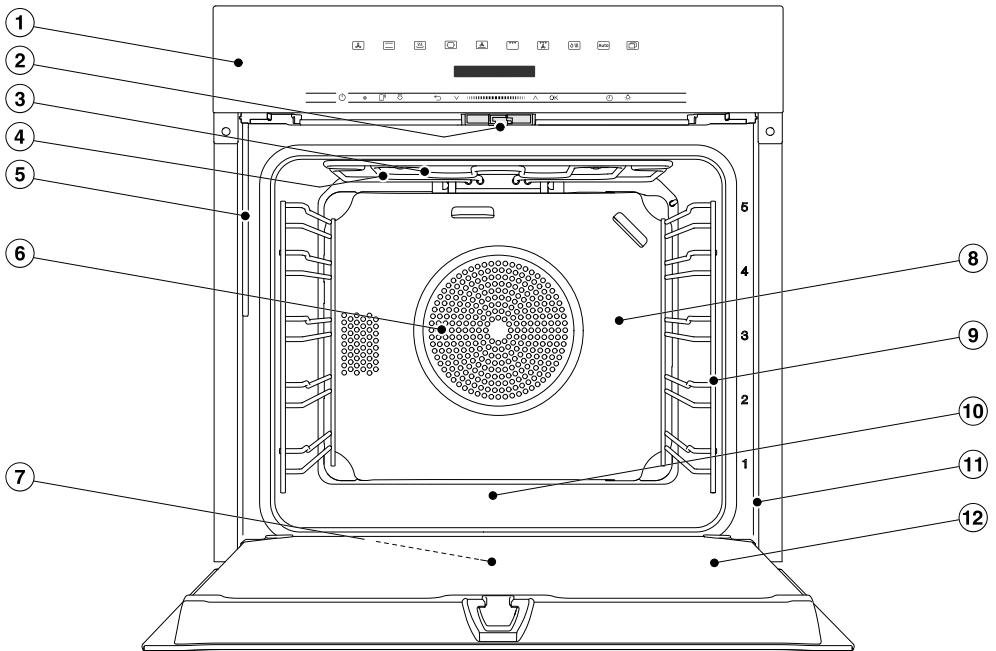



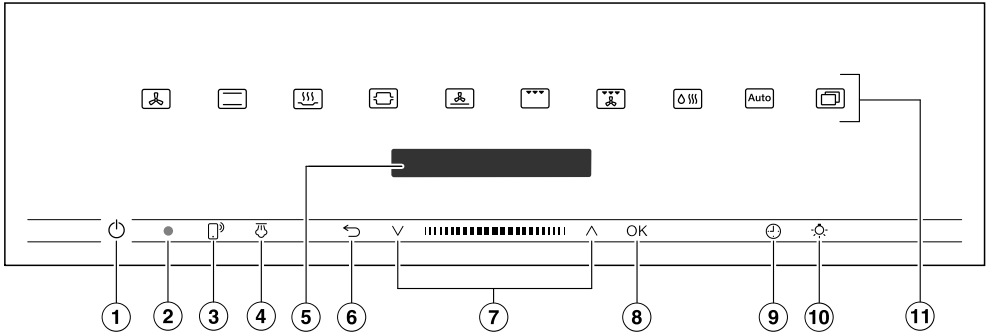

Steam combination oven



- ① Control panel
- ② Door lock
- ③ Top heat/grill element
- ④ Steam inlet opening
- ⑤ Water intake pipe for the steam injection system
- ⑥ Air inlet for the fan with ring heating element behind it
- ⑦ Drip channel
- ⑧ Catalytic enamelled back panel
- ⑨ Shelf runners with 5 shelf levels
- ⑩ Oven floor with bottom heat element underneath it
- ⑪ Front frame with data plate
- ⑫ Door

Controls



- ① Recessed On/Off  sensor
For switching the steam combination oven on and off
- ② Optical interface
(for Miele service technicians only)
- ③  sensor
For controlling the steam combination oven via your mobile device
- ④  sensor
For injecting the bursts of steam in the Moisture Plus  operating mode
- ⑤ Display
For displaying the time of day and information on operation
- ⑥  sensor
For going back a step and for changing menu options during a cooking programme
- ⑦ Navigation area with  and  arrow sensors
For scrolling through lists and for changing values
- ⑧ *OK* sensor
For calling up functions and saving settings
- ⑨  sensor
For setting a minute minder, the cooking duration or the start or finish time for the cooking programme
- ⑩  sensor
For switching the oven interior lighting on and off
- ⑪ Sensor controls
For selecting functions, Automatic programmes and settings

On/Off sensor

The On/Off  sensor is recessed and reacts to touch.

Use this sensor to switch the steam combination oven on and off.

Display

The display is used for showing the time of day or information about functions, temperatures, cooking durations, Automatic programmes and settings.

After switching the oven on with the On/Off  sensor, Select function will appear in the main menu.

Sensor controls

The sensors react to touch. Every touch of the sensors is confirmed by a keypad tone. You can switch off this keypad tone using Other  | Settings | Volume | Keypad tone.







If you want the sensors to respond even when the steam combination oven is switched off, select the Display | QuickTouch | On setting.



Sensor controls above the display

For information on the oven functions and further functions, see “Main and sub-menus”, “Settings”, “Automatic programmes” and “Other applications”.

Controls





Sensor controls under the display

Sensor	Function
	<p>If you want to control the steam combination oven from your mobile device, you must have the Miele@home system, switch on the Remote control setting and touch this sensor. The sensor then lights up and the MobileStart function is available.</p> <p>As long as this sensor is illuminated, you can control the steam combination oven via your mobile device (see “Settings – Miele@home”).</p>
	<p>After selecting manual steam injection for the Moisture Plus  function, you can use this sensor to inject steam.</p> <p>This sensor lights up orange as soon as a steam injection can be released.</p> <p> appears in the display while steam injection is in progress.</p>
	<p>Depending on which menu you are in, this sensor control will take you back a level or back to the main menu.</p> <p>If a cooking programme is in progress at the same time, use this sensor control to cancel the programme.</p>
	<p>In the navigation area, use the arrow sensors or the area between them to scroll up and down in the selection lists. The display shows the menu option that you want to select.</p> <p>You can change the values and settings using the arrow sensors or the area between them.</p>

Sensor	Function
OK	The <i>OK</i> sensor lights up orange as soon as a value, setting or prompt can be confirmed. By selecting this sensor you can access functions such as the minute minder, save changes to values or settings, or confirm instructions.
	If no cooking programme is in progress, you can use this sensor to set a minute minder (e.g. when boiling eggs on the cooktop) at any point. While a cooking programme is in progress, you can set a minute minder, the cooking duration and a start or finish time for the programme.
	Select this sensor to switch the oven interior lighting on and off. Depending on the setting selected, the oven interior lighting switches off after 15 seconds or remains constantly switched on or off.

Symbols

The following symbols may appear in the display:

Symbol	Meaning
	This symbol indicates that there is additional information and advice about using the appliance. Select <i>OK</i> to confirm the information.
	Minute minder
	A tick indicates the option which is currently selected.
	Some settings, e.g. display brightness and signal tone volume, are selected using a segment bar.
	The system lock prevents the steam combination oven being switched on by mistake (see “Settings – Safety”).

Operating principles

Use the \wedge and \vee arrow sensors or the **|||||** area between them in the navigation area to use the steam combination oven.

The *OK* sensor lights up orange as soon as a value, setting or prompt can be confirmed.

Selecting a menu option

- Touch the \wedge or \vee arrow sensor or swipe to the right or left in the **|||||** area until you reach the desired menu option.

Useful tip: If you press and hold an arrow sensor, the list continues scrolling automatically until you release the arrow sensor.

- Confirm your selection with *OK*.

Changing a setting in a list

A \checkmark tick will appear beside the current setting.

- Touch the \wedge or \vee arrow sensor or swipe to the right or left in the **|||||** area until you reach the desired value or setting.
- Confirm with *OK*.

The setting is now saved. This will take you back to the previous menu.

Changing the setting with a segment bar

Some settings are represented by a **■■■■■□□□** bar with seven segments. If all of the segments are illuminated, the maximum value is selected.

If none or only one of the segments is illuminated, the minimum value is selected or the setting is switched off altogether (e.g. volume).

- Touch the \wedge or \vee arrow sensor or swipe to the right or left in the **|||||** area until you reach the desired setting.
- Confirm your selection with *OK*.

The setting is now saved. This will take you back to the previous menu.

Selecting a function

The sensor controls for the functions are located above the display (see “Operation” and “Settings”).

- Touch the sensor for the desired function.

The sensor on the control panel will light up orange.

- For functions: set values such as the temperature.
- Under *Other* : scroll through the lists until you reach the desired menu option.
- Confirm with *OK*.

Changing the function

You can change to another function during a cooking programme.

The sensor for the previously selected function lights up orange.

- Touch the sensor for the new function.

The new function appears in the display with its corresponding recommended values.

The sensor for the new function lights up orange.

Under Other , scroll through the lists until you reach the desired menu option.

Entering numbers

Numbers that can be changed are highlighted.

- Touch the \wedge or \vee arrow sensor or swipe to the right or left in the **||||** area until the desired number is highlighted.

Useful tip: If you press and hold an arrow sensor, the numbers continue scrolling automatically until you release the arrow sensor.

- Confirm with *OK*.

The changed number is now saved. This will take you back to the previous menu.

Activating MobileStart

- Select the  sensor to activate MobileStart.



The  sensor lights up. You can operate your steam combination oven remotely with the Miele App.

Directly operating the steam combination oven takes priority over operating it via the remote control function on the App.

You can use MobileStart as long as the  sensor is lit up.

Operating principles

Drawing in water

The prompt to prepare water for the cooking process appears in the Steam cooking  and Moisture Plus  operating modes.

- Fill a suitable container with the required amount of fresh tap water.

Distilled or carbonated water or other liquids could damage the steam combination oven.

Only use cold, fresh tap water (below 20 °C).

- Open the door.
- Pull the water intake pipe forwards (located below the control panel on the left).

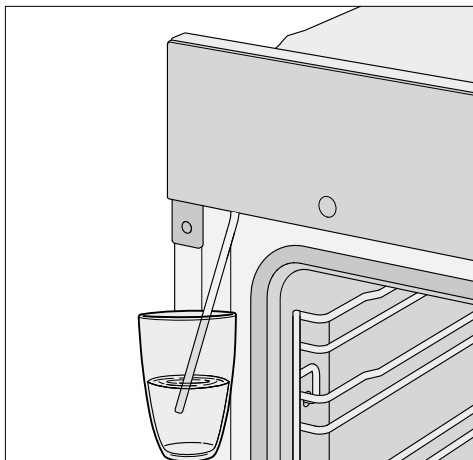

- Immerse the end of the water intake pipe in the container with fresh water.
- Confirm with *OK*.

The water intake process will begin.

The amount of water actually drawn up into the steam combination oven may be less than the amount specified as required, leaving a small amount in the container.

You can interrupt and resume the intake process at any time by selecting *OK*.

- Remove the water container after the water intake process and close the door.

The sound of the pump running can be heard again briefly. Residual water in the water intake pipe is being drawn into the oven.

The cooking process begins. The water is injected as bursts of steam into the oven compartment during the cooking programme. The steam outlets are located in the rear left corner of the ceiling of the oven compartment.

 Risk of injury due to hot steam. When using a cooking programme involving steam, a lot of hot steam can escape if the door is opened. The steam can cause burns. Step back and wait until the hot steam has dissipated.

A list of the models described in these operating and installation instructions can be found on the back page.

Data plate

The data plate located on the front frame of the oven is visible when the door is open.

The data plate states the model number, the serial number as well as connection data (voltage, frequency and maximum rated load).

Have this information available if you need to contact Miele so that any issues can be rectified as quickly as possible.

Items supplied

- Operating and installation instructions for using the steam combination oven
- A cookbook with recipes for the Automatic programmes and other functions
- Screws for fixing the steam combination oven to the housing unit
- Descaling tablets and a plastic tube with suction cup for descaling the steam injection system
- Various accessories

Accessories supplied and available to order

Features will vary depending on model.

The shelf runners, cooking containers, universal tray and wire rack (or “rack” for short) are supplied as standard with the steam combination oven.

Depending on the model, your steam combination oven may also come supplied with some of the accessories listed here.

All accessories and cleaning and care products listed in these instructions are designed for Miele steam combination ovens.

These are available to order via the Miele online shop or directly from Miele (see the end of this booklet for contact details).

When ordering, please quote the model number of your steam combination oven and the reference number of the accessories required.

Shelf runners

Shelf runners for accessories are fitted on either side of the oven cavity for shelf levels .

The shelf level numbers are marked on the front of the oven frame.

Each level consists of 2 rails, one above the other.

Accessories (e.g. the rack) are pushed into the oven between the two rails.

The shelf runners can be removed (see “Cleaning and care – Removing the shelf runners with FlexiClip telescopic runners”).

Features

Baking tray, universal tray and rack with non-tip safety notches

Baking tray HBB 71:

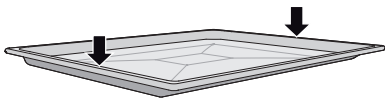

Universal tray HUBB 71:



Rack HBBR 71:



Insert these accessories into the shelf runners between the two rails of a shelf level.

The rack has a rail at the back to prevent dishes sliding off. Ensure the rack is inserted so that the rail is facing upwards.

Non-tip safety notches are located on accessories to prevent the trays being pulled out completely when you only wish to pull them out partially. They also prevent trays from tipping.

- The non-tip safety notches are located in the middle of the short sides of the baking tray and universal tray.
- The non-tip safety notches are located towards the back of the short sides of the rack.



If you are using the universal tray with the rack on top, insert the tray between the rails of a shelf runner and the rack will sit on top of it.

When using the Steam cooking  operating mode, **always** place the universal tray on shelf level 1 to catch any liquid.

FlexiClip telescopic runners HFC 70-C

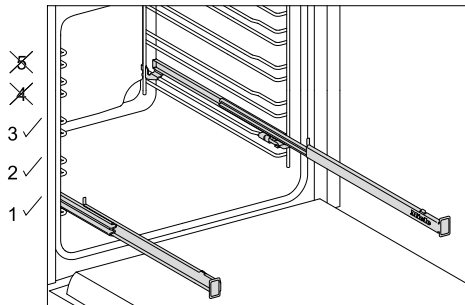

FlexiClip telescopic runners can only be fitted on levels 1, 2 and 3.

The FlexiClip telescopic runners can be drawn right out of the oven to give a good overview of the cooking in progress.

Push the FlexiClip telescopic runners right into the oven compartment before placing accessories on them.

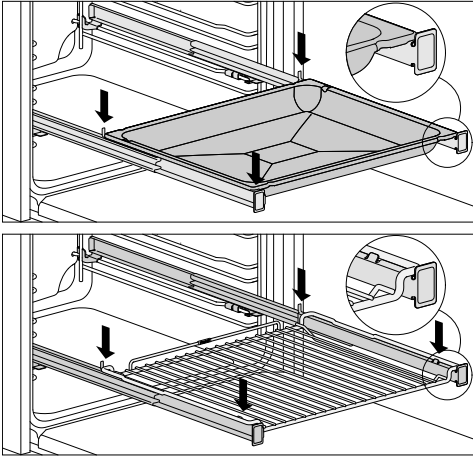

To prevent the risk of accessories sliding off the telescopic runners:

- Make sure that they are sitting securely on their runners in between the stoppers at either end of each runner.
- Always slide the rack onto the FlexiClip telescopic runners with the loading surface facing downwards.

The FlexiClip telescopic runners can support a maximum load of 15 kg.

Because the FlexiClip telescopic runners sit on the top rail of the shelf runners, the gap between the level that the FlexiClip telescopic runners are on and the one above is smaller than if, for instance, racks were fitted on each level. Cooking results will be affected if the gap is too small.

If you need to use more than one baking tray, universal tray or rack at a time:

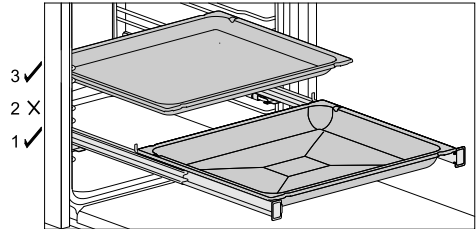

- Place the baking tray, universal tray or rack on the FlexiClip telescopic runners.
- Leave at least one shelf level free between it and any baking tray, universal tray or rack on the FlexiClip telescopic runners above it.

You can use the universal tray together with the rack on the FlexiClip telescopic runners.

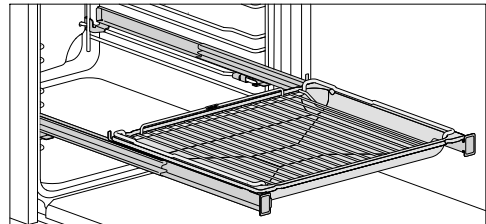

- Place the universal tray together with the rack on the FlexiClip telescopic runners. The rack will automatically slide between the rails of the shelf level above the FlexiClip telescopic runners.
- Leave at least one shelf level free between it and any baking tray, universal tray or rack on the FlexiClip telescopic runners above it.

Features

Fitting the FlexiClip telescopic runners

⚠ Risk of injury caused by hot surfaces.

The oven gets hot during operation. You could burn yourself on the heating elements, the oven compartment, or accessories.

Allow the heating elements, oven compartment and the accessories to cool down before fitting or removing the FlexiClip telescopic runners.

Preferably fit the FlexiClip telescopic runners onto level 1. You can then use them for food which should be cooked on level 2.

Each level of the shelf runners consists of two rails. The FlexiClip telescopic runners are fitted on the upper rail of the two rails that make up a shelf level.

The FlexiClip telescopic runner with the Miele logo is fitted on the right.

When fitting or removing the FlexiClip telescopic runners, do **not** extend them.

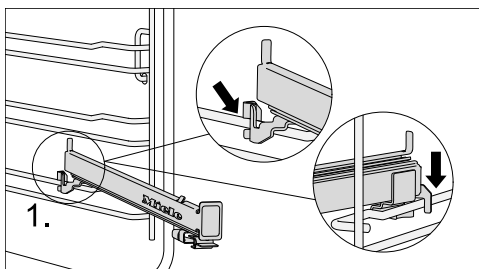

- Hook the FlexiClip telescopic runner onto the front of the top rail of a shelf runner (1.).

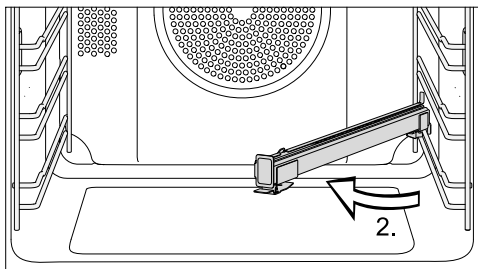

- Then hold the FlexiClip telescopic runner at an angle in towards the middle of the oven compartment (2.).

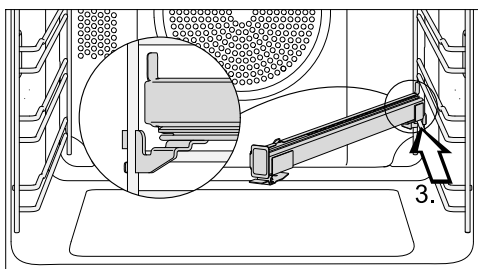

- Slide the FlexiClip telescopic runner at an angle along the top rail as far as it will go (3.).

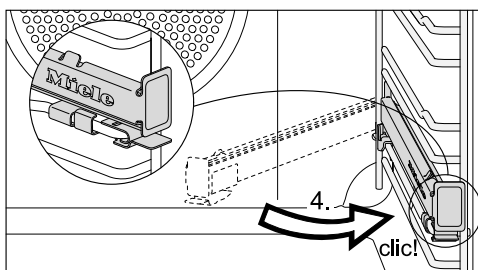

- Then swing the FlexiClip telescopic runner back to the side and secure it to the top rail with an audible click (4.).

If the FlexiClip telescopic runners are difficult to pull out after fitting, you may need to pull firmly on them once to release them.

Removing the FlexiClip telescopic runners

 Risk of injury caused by hot surfaces.

The oven gets hot during operation. You could burn yourself on the heating elements, the oven compartment, or accessories. Allow the heating elements, oven compartment and the accessories to cool down before fitting or removing the FlexiClip telescopic runners.

- Push the FlexiClip telescopic runner in all the way.

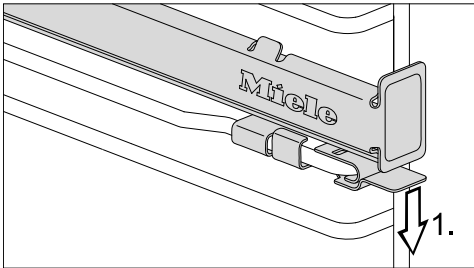

- Push down on the tab at the front of the FlexiClip telescopic runner (1.).

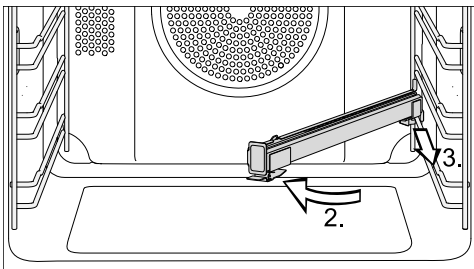

- Swing the FlexiClip telescopic runner towards the middle of the oven compartment (2.), then pull it forwards along the top rail (3.).
- Lift the FlexiClip telescopic runner off the rail and take it out of the oven.

Round baking trays



The **solid round baking tray HBF 27-1** is suitable for cooking pizzas, flat cakes made with yeast or whisked mixtures, sweet and savoury tarts, baked desserts, flat bread, and can also be used for frozen cakes and pizzas.

The **perforated round baking and AirFry tray HBFP 27-1** can be used for the same purposes as the **perforated Gourmet baking and AirFry tray HBBL 71**.

The surface of both baking trays has been treated with PerfectClean enamel.

- Insert the rack and place the round baking tray on the rack.

Gourmet baking and AirFry tray, perforated HBBL 71

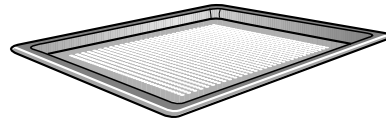

The fine perforations of the Gourmet baking and AirFry tray optimise cooking processes:

- Browning on the underside of baked goods made from fresh yeast and quark doughs, as well as bread and rolls is improved.
Firstly, roll out the dough on an even work surface and then place it on the Gourmet baking and AirFry tray.
- Chips, croquettes, or similar items can be fried in a hot air flow (AirFrying) without using fat.
- During dehydrating/drying, the air circulation around the food for drying is optimised.

Features

The surface has been treated with PerfectClean enamel.

The **perforated round baking and AirFry tray HBFP 27-1** can be used for these purposes.

The perforated Gourmet baking and AirFry tray and the perforated round baking and AirFry tray are not suitable for use with the Steam cooking  function.

Use the perforated trays and containers only for baking.

Baking stone HBS 70



The baking stone is ideal for items which need a well baked base such as pizza, quiche, bread, bread rolls and savoury snacks.

The baking stone is made from heat-retaining fireclay and is glazed. A paddle made of untreated wood is supplied with the baking stone for placing food on it and taking it off.

- Slide the rack in and place the baking stone on it.

Grilling and roasting insert HGBB 71

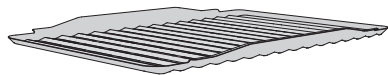

The grilling and roasting insert fits in the universal tray.

The tray will collect meat juices during grilling, roasting or AirFrying and stop them from burning so that they can be used for making gravy and sauces.

The enamelled surface has been treated with PerfectClean.

HUB Gourmet oven dishes HBD Gourmet oven dish lids

Unlike other oven dishes, the Miele Gourmet oven dishes can be placed in the oven directly on the shelf runners. They have non-tip safety notches like the rack to prevent them from being pulled out too far. The surface of the oven dishes has a non-stick coating.

Gourmet oven dishes are available in different depths. The width and the height are the same.

Suitable lids are available separately. Please quote the model number when ordering.

Depth: 22 cm

HUB 5000-M
HUB 5001-M*



HBD 60-22

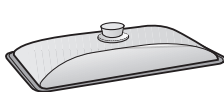

Depth: 35 cm

HUB 5001-XL*

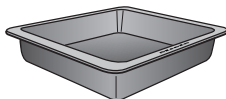

HBD 60-35



* Suitable for induction cooktops

Steam oven containers

This steam combination oven is supplied with stainless steel cooking containers. Other containers, in a variety of sizes, both perforated and solid, are available as optional extras.

Use perforated cooking containers for steam cooking if possible. The steam can reach the food from all sides and the food is cooked evenly.

Place the cooking container with food in it on shelf level 3.

Always place the universal tray on shelf level 1 to catch any liquid.

DGG 20

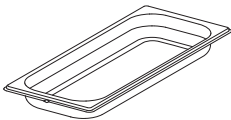

1 solid cooking container
Gross capacity 2.4 litres / Useable capacity 1.8 litres
450 x 190 x 40 mm (W x D x H)

DGGL 20

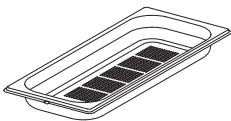

1 perforated cooking container
Gross capacity 2.4 litres / Useable capacity 1.8 litres
450 x 190 x 40 mm (W x D x H)

DGGL 12



1 perforated cooking container
Gross capacity 4.9 litres / Useable capacity 3.3 litres
450 x 390 x 40 mm (W x D x H)

Catalytic enamelled accessories

Back panel

This should be replaced if the catalytic enamel has become ineffective due to incorrect use or very heavy soiling.

When ordering, please quote the model number of your steam combination oven.

Handle HEG

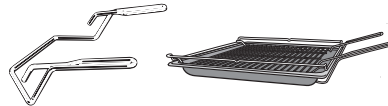

The handle makes it easier to take the universal tray, baking tray and rack out of the oven.

Accessories for cleaning and care

- Descaling tablets, plastic tube with suction cup for descaling the steam combination oven
- Miele all purpose microfibre cloth
- Miele oven cleaner

Features

Safety features

- **System lock** 
(see “Settings – Safety”)
- **Sensor lock**
(see “Settings – Safety”)
- **Cooling fan**
(see “Settings – Cooling fan run-on”)
- **Safety switch-off**
The safety switch-off is activated automatically if the steam combination oven has been operating for an unusually long period of time. The period of time will depend on the particular oven function being used.
- **Ventilated door**
The oven door is made of glass panes that have a heat-reflective coating on part of their surface. When the oven is operating, air is passed through the door to keep the outer pane cool. The door can be removed and disassembled for cleaning purposes (see “Cleaning and care”).

PerfectClean treated surfaces

Surfaces treated with PerfectClean enamel are characterised by their exceptional non-stick properties and ease of cleaning.

Food can be easily removed from these surfaces. Soiling from baking and roasting can be easily removed from these surfaces.

Food can be sliced or cut up on PerfectClean surfaces.

However, do not use ceramic knives as these will scratch the PerfectClean surface.

Surfaces treated with PerfectClean enamel can be cleaned as you would clean glass.

Read the instructions in “Cleaning and care” so that the benefits of the non-stick properties and easy cleaning are retained.

PerfectClean treated surfaces:

- Oven compartment
- Shelf runners
- Rack
- Universal tray
- Baking tray
- Grilling and roasting insert
- Gourmet baking and AirFry tray, perforated
- Round baking and AirFry tray, perforated
- Round baking tray

Before using for the first time

Miele@home

Your steam combination oven is equipped with an integrated Wi-Fi module.

To use this feature, you will need:

- a Wi-Fi network
- the Miele App
- a Miele user account. You can create a user account via the Miele App.

The Miele App will guide you as you connect your steam combination oven to your home Wi-Fi network.

Once your steam combination oven is connected to your Wi-Fi network, you can use the App for a number of actions, including the following:

- Call up information on the operating status of your steam combination oven
- Retrieve information on cooking processes that are in progress
- End cooking programmes that are in progress

Connecting your steam combination oven to your Wi-Fi network will increase energy consumption, even when it is switched off.

Make sure there is sufficient signal strength for your Wi-Fi network where the steam combination oven is installed.

Availability of the Wi-Fi connection

The Wi-Fi connection shares a frequency range with other appliances (including microwave ovens and remote control toys). This may result in sporadic or even complete connection failures. Therefore, a constant availability of featured functions cannot be guaranteed.

Miele@home availability

The ability to use the Miele App depends on the availability of the Miele@home service in your country.

The Miele@home service is not available in every country.

For information about availability, please visit www.miele.com.

Miele App

You can download the Miele App from the Apple App Store® or the Google Play Store™ free of charge (only functional in selected countries).



Before using for the first time

Standard settings

The following settings must be made before starting up for the first time. You can change these settings again at a later time (see “Settings”).

 Risk of injury caused by hot surfaces.

The steam combination oven gets hot during operation.

For safety reasons, this steam combination oven must only be used after it has been built in.

The steam combination oven will switch on automatically when it is connected to the electricity supply.

Setting the language

- Select the language you want.
- Confirm with *OK*.

If you have accidentally selected a language that you don't understand, proceed as described in “Settings – Language ”.

Setting the location

- Select the required location.
- Confirm with *OK*.

Setting up Miele@home

Set up “Miele@home” appears in the display.

- To set up Miele@home immediately, confirm by touching *OK*.
- To set it up at a later date, select *Skip* and confirm with *OK*. See “Settings – Miele@home” for information on setting up at a later date.
- To set up Miele@home immediately, select the desired connection method.

You will then be guided by the display and the Miele App.

Setting the time of day

- Set the time of day in hours and minutes.
- Confirm with *OK*.

Setting the water hardness level

Contact your local water supplier to find out your local water hardness range if necessary.

See the “Settings - Water hardness” for more information.

- Set the water hardness level for your area.
- Confirm with *OK*.

Completing the commissioning process

- Follow any further instructions in the display.

The appliance is now ready for use.

Before using for the first time

Heating up the steam combination oven for the first time and rinsing the steam injection system

When the steam combination oven is heated up for the first time it may give off a slight smell. This can be eliminated by heating the empty steam combination oven for at least one hour. It is a good idea to rinse out the steam injection system at the same time.

Ensure that the kitchen is well ventilated while the appliance is being heated up for the first time. Prevent odours from escaping into other rooms.

- Remove any protective foil and stickers except the data plate from the steam combination oven and accessories.
- Before heating the oven up, wipe the interior with a damp cloth to remove any dust or bits of packaging that may have accumulated during storage and unpacking.
- Fit the FlexiClip telescopic runners to the shelf runners and insert all trays and the rack.
- Switch the steam combination oven on with the On/Off  sensor.

Select function appears in the display.

- Select Moisture Plus .

The recommended temperature will appear (160 °C).

The oven heating, lighting and cooling fan will switch on.

- Set the maximum possible temperature (250 °C).
- Confirm with *OK*.
- Select Automatic burst of steam.

The prompt to draw in water appears.

- Fill a suitable container with the required amount of fresh tap water and follow the instructions in the display (see "Operating principles – Drawing in water").

Heat up the empty steam combination oven for at least one hour.

- Switch the steam combination oven off with the On/Off  sensor after at least one hour.

Cleaning the oven compartment after heating it up for the first time

 Risk of burning due to hot surfaces.

The steam combination oven gets hot during operation. You could burn yourself on the heating elements, the oven compartment, or accessories.





Allow the heating elements, oven compartment and the accessories to cool before manual cleaning.

- Take all accessories out of the oven and clean them by hand (see "Cleaning and care").
- Clean the oven compartment with a clean sponge and a solution of hot water and washing-up liquid or a clean, damp microfibre cloth.
- Dry all surfaces with a soft cloth.

Leave the oven door open until the oven compartment is completely dry.

Settings

Settings overview

Menu option	Available settings
Language 	... deutsch english ... Location
Time	Display On* Off Night dimming Clock format 12 h 24 h* Set
Lighting	On "On" for 15 seconds* Off
Display	Brightness  * QuickTouch On Off*
Volume	Buzzer tones Melodies  * Solo tone  * Keypad tone  * Welcome melody On* Off
Units	Temperature °C* °F
Booster	On* Off
Rapid cooling	On* Off
Keeping warm	On Off*

* Factory settings



Menu option	Available settings
Recommended temps	
Cooling fan run-on	Temperature-controlled* Time-controlled
Water hardness	1° dH ... 15° dH* ... 70° dH
Altitude	0 - 250 m* ... 751 - 1000 m ... 1751 - 2000 m
Safety	Sensor lock On Off* System lock  On Off*
Miele@home	Activate Deactivate Connection status Set up again Reset Set up
Remote control	On* Off
RemoteUpdate	On* Off
Software version	
Showroom programme	Demo mode On Off*
Factory default	Appliance settings Recommended temps

* Factory settings

Settings

Opening the "Settings" menu

In the Other  | Settings menu, you can personalise your steam combination oven by adapting the factory default settings to suit your requirements.



- Select Other .
- Select Settings .
- Select the desired setting.

You can check settings or change them.

Settings cannot be altered while a cooking programme is in progress.

Language

You can set your language and location. After selecting and confirming your choice, the language you have selected will appear in the display.

Useful tip: If you have selected the wrong language by mistake, select the  sensor. Follow the  symbol to get back to the Language  sub-menu.

Time

Display

Select how you want the time of day to appear in the display when the steam combination oven is switched off:

- On
The time always appears in the display.
If you also select the Display | QuickTouch | On setting, all sensors react to touch as normal.
If you also select the Display | QuickTouch | Off setting, the steam combination oven has to be switched on before it can be used.

- Off
The display switches off and goes dark to save energy. The steam combination oven has to be switched on before you can use it.
- Night dimming
To save energy, the time is only visible in the display between 5:00 am and 11:00 pm. The display remains dark at all other times.

Clock format

The time of day can be displayed in the 24 or 12-hour format (24 h or 12 h).



Set

Set the hours and then the minutes.

If there is a power cut, the current time of day will reappear once power has been restored. The time of day is saved for approx. 150 hours.

If the steam combination oven has been connected to a Wi-Fi network and signed into the Miele App, the time will be synchronised based on the location setting in the Miele App.



Lighting

- On
The oven interior lighting is switched on during the entire cooking period.
- "On" for 15 seconds
The oven interior lighting switches off 15 seconds after a cooking programme has begun. Press the  sensor to switch the oven interior lighting on again for 15 seconds.
- Off
The oven interior lighting is switched off. Press the  sensor to switch on the oven interior lighting for 15 seconds.

Display

Brightness

The display brightness is represented by a segment bar.

-  Maximum brightness
-  Minimum brightness

QuickTouch

Select how the sensors should respond when the steam combination oven is switched off:

- On
If you have also selected the Time | Display | On or Night dimming setting, the sensors will also respond when the steam combination oven is switched off.
- Off
Independently of the Time | Display setting, the sensors only respond when the steam combination oven is switched on, as well as for a certain amount of time after switching it off.

Volume



Buzzer tones

If buzzers are switched on, a buzzer will sound when the set temperature is reached and at the end of a set time.

Melodies

At the end of a process, a melody will sound several times at intervals.



The volume of the melody is represented by a segment bar.

-  Maximum volume
-  Melody is switched off

Solo tone



At the end of a process, a continuous tone will sound for a period of time.

The pitch of this continuous tone is represented by a segment bar.

-  Highest pitch
-  Lowest pitch

Keypad tone

The volume of the tone that sounds each time you touch a sensor is represented by a segment bar.

-  Maximum volume
-  Keypad tone is switched off

Welcome melody

The melody that sounds when you touch the On/Off  sensor can be switched on or off.

Settings

Units

Temperature

You can set the temperature in degrees Celsius (°C) or degrees Fahrenheit (°F).

Booster

The Booster function is used to quickly pre-heat the oven.

- On
The Booster function is automatically switched on during the heating-up phase of a cooking programme. The top heat/grill element, ring heating element and hot air fan pre-heat the oven compartment to the set temperature at the same time.
- Off
The Booster function is switched off during the heating-up phase of a cooking programme. Only the heating elements for the selected oven function are used to pre-heat the oven compartment.

Rapid cooling

Using the Rapid cooling function you can quickly cool down food and the oven compartment once the cooking programme is finished.

This function is useful if, for example, you immediately want to start an Automatic programme for which the oven compartment needs to be cold.

Using the Keeping warm function you can keep food warm after cooking without inadvertently cooking it further.

- On
The Rapid cooling function is switched on. Once the cooking programme has finished, the door opens a little

automatically. The cooling fan cools the food and the oven compartment quickly.

- Off
The Rapid cooling function is switched off. The door remains closed at the end of the cooking programme. The cooling fan cools the food and the oven compartment.

Keeping warm

Using the Keeping warm function you can keep food warm after cooking without inadvertently cooking it further. The food is kept warm at a preset temperature (Settings | Recommended temps | Keeping warm).

It is only possible to use the Keeping warm function in combination with the Rapid cooling function.

- On
The Keeping warm function is switched on. Once the cooking programme has finished, the door opens a little automatically. The cooling fan cools the food and the oven compartment quickly to the preset temperature. Once this temperature is reached, the door closes again automatically in order to keep the food warm.
- Off
The Keeping warm function is switched off. The door remains closed at the end of the cooking programme. The cooling fan cools the food and the oven compartment.

Recommended temps

If you frequently cook with different temperatures, it makes sense to change the recommended temperatures.

After selecting this menu option, the list of functions will appear in the display together with their recommended temperatures.

- Select the function you want.
- Change the recommended temperature.
- Confirm with *OK*.

You can also change the recommended temperature for the Keeping warm function.

Cooling fan run-on

The cooling fan will continue to run for a while after the oven has been switched off to prevent humidity building up in the oven compartment, on the control panel or on the oven housing unit.

- Temperature-controlled
The cooling fan switches off when the temperature in the oven drops below 70 °C.
- Time-controlled
The cooling fan switches off after a period of about 25 minutes.

Condensate can damage the steam combination oven housing unit, damage the worktop and lead to corrosion in the steam combination oven.

If you have set the cooling fan to Time-controlled and leave food in the oven compartment to keep warm, moisture levels in the oven will increase, leading to condensation forming on the fascia panel and surrounding kitchen furniture, and drops of moisture collecting under the worktop.

Do not leave food in the oven to keep it warm if you have set the cooling fan to Time-controlled.

Settings

Water hardness

To ensure that the steam combination oven works correctly and to ensure that descaling is carried out at the correct interval, it must be set to the local water hardness level. The harder the water is, the more frequently the steam combination oven needs to be descaled. Contact your local water supplier to find out your local water hardness range if necessary.

If you are using an on-site water softener, match the setting on the steam combination oven to the value set on the water softener.

If you are using an on-site system to fully demineralise the water (e.g. a reverse osmosis system), the system must be set so the conductivity of the treated water is at least 100 $\mu\text{S}/\text{cm}$. In the case of most water qualities, this can be achieved by setting a water hardness of at least 0.54 mmol/l (3 $^{\circ}\text{dH}$) rather than fully demineralising the water. The conductivity is required for the fill level detection in the steam generator. Match the setting on the steam combination oven to the value set on the full demineralisation system.

If you are using bottled water, it must comply with the relevant national regulations for drinking water quality. Do not use mineral water or carbonated water. Adjust the setting on the steam combination oven depending on the calcium content. The calcium content is specified on the label of the bottle in mg/l Ca^{2+} or ppm (mg/l CaCO_3).

Water hardness			Calcium content mg/l Ca^{2+}	Calcium carbonate content ppm (mg/l CaCO_3)	Setting on steam combination oven
$^{\circ}\text{dH}$	$^{\circ}\text{fH}$	mmol/l			
1	1.8	0.18	7	18	1
2	3.6	0.36	14	36	2
3	5.4	0.54	21	54	3
4	7.1	0.72	29	71	4
5	8.9	0.90	36	89	5
6	10.7	1.07	43	107	6
7	12.5	1.25	50	125	7
8	14.3	1.43	57	143	8
9	16.0	1.61	64	161	9
10	17.9	1.79	71	179	10
11	19.6	1.97	79	196	11
12	21.4	2.15	86	214	12
13	23.2	2.33	93	232	13
14	25.0	2.51	100	250	14

Settings

Water hardness			Calcium content mg/l Ca ²⁺	Calcium carbonate content ppm (mg/l CaCO ₃)	Setting on steam combination oven
°dH	°fH	mmol/l			
15	26.8	2.69	107	268	15
16	28.6	2.86	114	286	16
17	30.4	3.04	121	304	17
18	32.1	3.22	129	321	18
19	33.9	3.40	136	339	19
20	35.7	3.58	143	357	20
21	37.5	3.76	150	375	21
22	39.3	3.94	157	393	22
23	41.1	4.12	164	411	23
24	42.9	4.30	171	429	24
25	44.6	4.47	179	446	25
26	46.4	4.65	186	464	26
27	48.2	4.83	193	482	27
28	50.0	5.01	200	500	28
29	51.8	5.19	207	518	29
30	53.6	5.37	214	536	30
31	55.4	5.55	221	554	31
32	57.1	5.73	228	571	32
33	58.9	5.91	236	589	33
34	60.7	6.09	243	607	34
35	62.5	6.27	250	625	35
36	64.3	6.44	257	643	36
37–45	66–80	6.62–8.06	264–321	661–804	37–45
46–60	82–107	8.23–10.74	328–428	821–1071	46–60
61–70	109–125	10.92–12.53	436–500	1089–1250	61–70

Settings

Altitude

The boiling temperature of the water varies depending on the altitude of the installation location. This setting enables you to adjust the boiling temperature after moving house if the altitude differs from the old one by 300 m or more.

Safety

Sensor lock

The sensor lock prevents the cooking programme being switched off by mistake or settings being changed. Apart from the On/Off  sensor, the activated sensor lock prevents the sensors and fields in the display from working a few seconds after a programme has been started.

- On
The sensor lock is switched on. Touch the *OK* sensor for at least 6 seconds to deactivate the sensor lock for a short period of time.
- Off
The sensor lock is deactivated. All sensor controls react to touch as normal.

If you want to switch off the appliance with the sensor lock activated, touch the On/Off  sensor until the appliance switches off.

System lock

The system lock prevents the steam combination oven being switched on by mistake.

The minute minder and the MobileStart function can still be used when the system lock is active.

The system lock will remain activated even after a power failure.

- On
The system lock is switched on. Before you can use the steam combination oven, touch the *OK* sensor for at least 6 seconds.
- Off
The system lock is deactivated. You can use the steam combination oven as usual.

Miele@home

The steam combination oven is one of the Miele@home-enabled domestic appliances. Your steam combination oven is fitted ex-works with a Wi-Fi communication module and is suitable for wireless communication.

There are a number of ways of connecting your steam combination oven to your Wi-Fi network. We recommend connecting your steam combination oven to your Wi-Fi network with the help of the Miele App or via WPS.

- Activate
This setting is only visible if Miele@home is deactivated. The Wi-Fi function is reactivated.
- Deactivate
This setting is only visible if Miele@home is activated. Miele@home remains set up, the Wi-Fi function is switched off.
- Connection status
This setting is only visible if Miele@home is activated. The display shows information such as the Wi-Fi reception quality, network name and IP address.

- Set up again
This setting is only visible if a Wi-Fi network has already been set up. Reset the network settings and immediately set up a new network connection.
- Reset
This setting is only visible if a Wi-Fi network has already been set up. The Wi-Fi function is deactivated and the Wi-Fi network will be reset to the factory default. You must set up a new connection to the Wi-Fi network to be able to use Miele@home. The network settings should be reset whenever the steam combination oven is being disposed of or sold, or if a used steam combination oven is being put into operation. This is the only way to ensure that all personal data has been removed and, in the case of the latter, the previous owner will no longer be able to access the steam combination oven.
- Set up
This setting is only visible if no connection to the Wi-Fi network has been set up yet. You must set up a new connection to the Wi-Fi network to be able to use Miele@home.

Remote control

If you have installed the Miele App on your mobile device, have access to the Miele@home system and have activated the remote control function (On), you can use the MobileStart function and, for example, retrieve information on steam combination oven cooking programmes currently in progress or to end a programme in progress.

The steam combination oven requires max. 2 W in networked standby.

Activating MobileStart

- Select the  sensor to activate MobileStart.

The  sensor lights up. You can operate your steam combination oven remotely with the Miele App.

Directly operating the steam combination oven takes priority over operating it via the remote control function on the App.

You can use MobileStart as long as the  sensor is lit up.

RemoteUpdate

The RemoteUpdate menu option is only displayed and can only be selected if the requirements for using Miele@home have been met (see “Before using for the first time – Miele@home” or “Settings”).

The RemoteUpdate function is used for updating the software in your steam combination oven. If an update is available for your steam combination oven, it will be downloaded automatically by your steam combination oven. Updates will not be installed automatically. They must be initiated manually.

If you do not install an update, you can continue to use your steam combination oven as usual. However, Miele recommends installing updates.

Switching on/Switching off

RemoteUpdate is switched on as standard. Available updates will be downloaded automatically and will only be installed if you initiate it.

Switch off RemoteUpdate if you do not wish any updates to be downloaded.

Settings

Running a RemoteUpdate

Information about the content and scope of an update is provided in the Miele App.

A message will appear in your steam combination oven display if a software update is available.

You can install the update immediately or postpone this until later. When the steam combination oven is switched on again, you will be reminded about the update.

Deactivate RemoteUpdate if you do not want to install the update.

The update may take several minutes.

Please note the following information about the RemoteUpdate function:

- You will only receive a message when an update is available.
- Once an update has been installed, it cannot be undone.
- Do not switch the steam combination oven off during the update. Otherwise, the update will be aborted and will not be installed.
- Some software updates can only be carried out by a Miele service technician.

Software version

The software version menu option is for use by Miele service technicians. You do not need this information for domestic use.

Showroom programme

This function enables the steam combination oven to be demonstrated in showrooms without heating up. Do not activate this setting for domestic use.

Demo mode

If you switch on the steam combination oven whilst it is in Demo mode, the following message will appear in the display: Demo mode is activated. The appliance will not heat up..

- On
Touch the *OK* sensor for at least 4 seconds to activate Demo mode.
- Off
Touch the *OK* sensor for at least 4 seconds to deactivate Demo mode. You can use the steam combination oven as usual.

Factory default

- Appliance settings
Any settings that have been altered will be reset to the factory default settings.
- Recommended temps
Any recommended temperatures that have been changed will be reset to the factory default settings.

Operating hours

Select Other  | Operating hours to query the total number of operating hours of your steam combination oven.

Using the Min. minder function

The  minute minder can be used to time other activities in the kitchen, e.g. boiling eggs on the cooktop.

The minute minder can also be used at the same time as a cooking programme for which the cooking duration start and finish times have been set (e.g. as a reminder to stir the food or add seasoning, etc.).

- The maximum minute minder time that can be set is 59 minutes and 59 seconds.

Useful tip: When using a function that uses moisture, use the timer to remind you to inject steam manually at the desired time.

Setting the minute minder

If you have selected the Display | QuickTouch | Off setting, you will need to switch the steam combination oven on before setting the minute minder. The minute minder can then be seen counting down in the display when the steam combination oven is switched off.

Example: You want to boil some eggs and set a minute minder time of 6 minutes and 20 seconds.

- Select the  sensor.
- Select Min. minder if a cooking programme is in progress at the same time.

The prompt Set 00:00 min will appear.

- Using the navigation area, set 06:20.
- Confirm with *OK*.

The minute minder duration is now saved.

When the oven is switched off, the minute minder time counts down in the display and  appears instead of the time of day.

If you are cooking at the same time **without** a set cooking duration,  and the minute minder time will appear as soon as the selected temperature is reached.

If you are cooking at the same time **with** a set cooking duration, the minute minder will count down in the background as the cooking duration takes priority in the display.

If you are in a menu, the minute minder will count down in the background.

At the end of the minute minder time  will flash, the time will start counting up and a buzzer will sound.

- Select the  sensor.
- If required, confirm with *OK*.

The buzzer will stop and the symbols in the display will go out.

Changing the time set for the minute minder

- Select the  sensor.
- Select Min. minder if a cooking programme is in progress at the same time.
- Select Change.
- Confirm with *OK*.

The minute minder time selected appears.

- Change the time set for the minute minder.
- Confirm with *OK*.

The altered minute minder time is now saved.











Min. minder

cancelling the minute minder

- Select the ⊕ sensor.
- Select Min. minder if a cooking programme is in progress at the same time.
- Select Delete.
- Confirm with *OK*.





The minute minder is now cancelled.

Main and sub-menus

Menu	Recommended value	Range
Oven functions		
Fan Plus 	160 °C	30–250 °C
Conventional Heat 	180 °C	30–250 °C
Steam cooking 	100 °C	70–100 °C
Auto Roast 	160 °C	100–230 °C
Intensive Bake 	170 °C	50–250 °C
Full Grill 	240 °C	200–250 °C
Fan Grill 	200 °C	100–250 °C
Moisture Plus 	160 °C	130–250 °C
Automatic programmes 		
Other 		
Bottom Heat	190 °C	100–250 °C
Eco Fan Heat	190 °C	100–250 °C
Defrost	25 °C	25–50 °C
Maintenance		
Descale		
Soak		
Drying		
Settings 		

Energy saving tips

Cooking programmes

- Remove any accessories from the oven that are not required for a cooking programme.
- In general, if a range of temperatures is given in a recipe or chart, it is best to select the lower temperature and to check the food after the shortest duration.
- Pre-heat the oven only if instructed to do so in the recipe or the cooking chart.
- Avoid opening the door during a cooking process.
- It is best to use dark bakeware and cooking containers with a matt finish made of non-reflective materials (enamelled steel, heat-resistant glass, non-stick coated cast aluminium). Shiny materials such as stainless steel or aluminium reflect the heat, preventing it from reaching the food efficiently. Do not cover the oven floor or the rack with heat-reflective aluminium foil.
- Monitor cooking durations to avoid wasting energy when cooking food. Set the cooking duration or use a food probe if you have one.
- The Fan Plus  function can be used for cooking many types of food. Because the fan distributes the heat in the oven compartment straight away, it allows you to use a lower temperature than you would with Conventional Heat . It also enables you to cook on several shelf levels at the same time.
- Eco Fan Heat  is an innovative function which is suitable for small amounts of food, e.g. frozen pizzas, bake-off rolls, biscuits and for meat dishes and roasts. The cooking process is energy-efficient thanks to optimal utilisation of heat. When cooking on a single level, up to 30% less energy is used with comparatively good cooking results. Do not open the door during the cooking programme.
- Fan Grill  is the best function for grilled dishes. With Fan Grill you can use lower temperatures than with other grill functions which use the maximum temperature setting.
- Whenever possible you should cook several dishes at the same time. Place them next to each other in the oven or on different shelf levels.
- Dishes which you are unable to prepare at the same time should, if possible, be cooked one after the other in order to make use of existing heat in the oven.

Using residual heat

- The temperature in cooking programmes using temperatures above 140 °C which take longer than 30 minutes to cook can be turned down to the lowest possible temperature about 5 minutes before the end of cooking. The residual heat in the oven is sufficient for cooking the food. However, do not switch the steam combination oven off (see "Warning and safety instructions").
- If you wish to run the programme for cleaning oil and grease off the catalytic enamelled parts of the oven, it is best to do so immediately after a cooking programme. The residual heat in the oven will help reduce the amount of energy required.

Customising settings

- Select the setting Display | QuickTouch | Off for the control elements in order to reduce energy consumption.
- Select the Lighting | Off or "On" for 15 seconds setting for the oven interior lighting. The oven interior lighting can be switched on again at any time by touching the  sensor.

Energy saving mode

The steam combination oven will switch itself off automatically to save energy if a programme is not being run and controls have not been operated. The time of day will appear in the display or the display will remain dark (see "Settings").

Operation

- Switch the steam combination oven on.

The main menu will appear.



- Select the function you want.

The function will appear first, followed by the recommended temperature.

- Change the recommended temperature and set the cooking duration, if necessary.

Otherwise the recommended temperature will be accepted within a few seconds. You can change the temperature later via the arrow sensors.

- Confirm with *OK*.
- Select the required bursts of steam in the Moisture Plus  operating mode (see "Moisture Plus").

The prompt to prepare water for the cooking process appears in the Steam cooking  and Moisture Plus  operating modes.

- Fill a suitable container with the required amount of fresh tap water and follow the instructions in the display (see "Operating principles – Drawing in water").
- Place the food in the oven.

The current temperature will appear and the heating-up phase will begin.

You will see the temperature rising in the display. A buzzer will sound when the selected temperature is reached for the first time.

- After cooking, select the sensor for the selected function to end the cooking programme.

 Risk of injury due to hot steam.

When using a cooking programme involving steam, a lot of hot steam can escape if the door is opened. The steam can cause burns.

Step back and wait until the hot steam has dissipated.

- Take the food out of the oven.

Drying the oven compartment after a steam cooking process

We recommend drying the oven compartment with the Drying maintenance programme after a cooking process has finished in the Steam cooking  operating mode.

The Drying maintenance programme consists of up to 3 phases: residual water evaporation in the empty oven compartment, drying by heating up the oven compartment and rapid cooling with the door slightly open. You will need to carry out the Drying maintenance programme to protect the oven compartment from corrosion and to completely evaporate any residual moisture.

- Follow the instructions in the display.
- Use a sponge or soft cloth to remove any water and condensation in the oven compartment and drip channel.
- Close the door.
- If the Drying maintenance programme has finished, switch off the steam combination oven.

Refilling the water

If, during a cooking process using moisture, there is too little water in the water container, a tone will sound and a message will appear to prompt you to fill the container with fresh tap water.

 Risk of injury due to hot steam. When using a cooking programme involving steam, a lot of hot steam can escape if the door is opened. The steam can cause burns. Step back and wait until the hot steam has dissipated.

- Fill a suitable container with the required amount of fresh tap water and follow the instructions in the display (see "Operating principles – Drawing in water").

The heating-up phase restarts and the cooking process continues.



Changing values and settings for a cooking programme

Depending on the function, as soon as a cooking programme is in progress, you can change the values or settings for this programme.

Depending on the function, you can change the following settings:

- Temperature
- Duration
- Finish at
- Start at

Changing the temperature

You can permanently reset the recommended temperature to suit your cooking preferences by selecting Other  | Settings  | Recommended temps.

- Select the \wedge or \vee arrow sensor or swipe to the right or left in the  area.

The target temperature appears in the display.

- Change the target temperature via the navigation area.

The temperature changes in 5 °C steps.

- Confirm with *OK*.

The cooking programme will restart with the new target temperature.

Setting cooking durations

Cooking results can be adversely affected if there is a long delay between the food being placed in the oven and the start of cooking. Fresh food can change colour and even spoil.

When baking, the cake mixture or dough can dry out, and the raising agents can lose their effectiveness.

Select as short a time as possible until the start of the cooking process.

Example: You have placed the food in the oven compartment, selected a function and the required settings such as the temperature.

By entering Duration, Finish at or Start at via the  sensor, you can automatically switch the cooking programme off, on and off.

- Duration

Enter the required cooking duration for the food. The heating will switch off automatically once this duration has elapsed. The maximum cooking duration that can be set depends on the function that you have selected.

Operation

- Finish at
Specify when you want the cooking programme to finish. The oven heating will switch off automatically at the time you have set.
 - Start at
This function will only appear in the menu if you have set a Duration or Finish at time. With Start at, you have to specify when you want the cooking programme to start. The oven heating will switch on automatically at the time you have set.
- Select the ⌚ sensor.
 - Set the required times.
 - Confirm with *OK*.
 - Touch the ↩ sensor to return to the menu of the selected function.

Changing the set cooking durations

- Select the ⌚ sensor.
- Select the time.
- Confirm with *OK*.
- Select *Change*.
- Change the set time.
- Confirm with *OK*.
- Touch the ↩ sensor to return to the menu of the selected function.

These settings will be deleted in the event of a power failure.

Deleting the set cooking durations

- Select the ⌚ sensor.
- Select the time.
- Confirm with *OK*.
- Select *Delete*.
- Confirm with *OK*.

- Touch the ↩ sensor to return to the menu of the selected function.

If you delete Duration, the set times for Finish at and Start at are also deleted.

If you delete Finish at or Start at, the cooking programme will start using the cooking duration set.

Cancelling cooking

- Touch the sensor for the selected function or the ↩ sensor.
- When *Cancel process* appears in the display, confirm with *OK*.

The oven compartment heating and lighting will then switch off. Any cooking durations set will be deleted.

The main menu will appear.

When the Rapid cooling function is switched on, the door automatically opens a little when the cooking programme is finished, and the cooling fan quickly cools the food and the oven compartment.

Touch the sensor for the selected function to return to the main menu.

Interrupting a cooking programme in the Steam cooking function

We recommend leaving the door closed during a cooking process with pure steam so that steam does not escape and the oven compartment temperature does not decrease.

You can interrupt cooking and pause the cooking duration when using the Steam cooking  operating mode, as well as with programmes and applications that use pure steam.

 Risk of injury due to hot steam. When using a cooking programme involving steam, a lot of hot steam can escape if the door is opened. The steam can cause burns. Step back and wait until the hot steam has dissipated.

- If you want to interrupt the cooking process, open the oven door while cooking is in progress.

Cooking is interrupted and the cooking duration is paused.

 Risk of injury caused by hot surfaces and food.

The steam combination oven gets hot during operation. You could burn yourself on the heating elements, oven compartment, shelf runners, accessories or food.

Wear oven gloves when placing food in the oven or removing it, and when adjusting oven shelves etc. in a hot oven.

When placing cooking containers in the oven or removing them, make sure that the hot food does not spill.





- When you want to continue the cooking process, close the oven door.

The cooking process will continue with the current oven compartment temperature. The remaining time will continue to count down.

Pre-heating the oven



The **Booster** function is used to quickly pre-heat the oven compartment in some functions.





It is only necessary to pre-heat the oven in a few instances.

- Most dishes can be placed in a cold oven. They will then make use of the heat produced during the heating-up phase.
- Pre-heat the oven for the following preparations and oven functions:
 - Dark bread dough and beef sirloin joints and fillet with the **Fan Plus** , **Moisture Plus**  and **Conventional Heat** functions 
 - Cakes and pastries with a short cooking duration (approx. 30 minutes or less) as well as delicate items (e.g. sponge) with the **Conventional Heat**  function (without the **Booster** function)

Booster

The **Booster** function is used to quickly pre-heat the oven compartment in some functions.

This function is switched on as the factory default setting for the following functions (**Other**  | **Settings**  | **Booster** | **On**):

- **Fan Plus** 
- **Conventional Heat** 
- **Auto Roast** 
- **Moisture Plus** 

If you set a temperature above 100 °C and the **Booster** function is switched on, a rapid heating-up phase heats the oven compartment to the set temperature. The top heat/grill element and the ring heating element come on together with the hot air fan.

Delicate items (e.g. sponge or biscuits) will brown too quickly on the top if the **Booster** function is used. Switch off the **Booster** function for these items.

Operation

Switching off Booster for a cooking programme

- Select the **Booster | Off** setting before selecting the desired function.

The **Booster** function is switched off during the heating-up phase. Only the heating elements for the selected oven function are used to pre-heat the oven compartment.

If you then want to restart a cooking programme with the **Booster** function, select the **Booster | On** setting to switch the function on again.

Rapid cooling

Using the **Rapid cooling** function you can quickly cool down food and the oven compartment once the cooking programme is finished.

This function is not available with the **Steam cooking**  operating mode.

Switching off Rapid cooling for a cooking programme

- Select the **Rapid cooling | Off** setting before selecting the desired function.

If the **Keeping warm** function is also switched on, When “**Rapid cooling**” is deactivated, “**Keeping warm**” is also switched off **will appear**.

The **Rapid cooling** and **Keeping warm** functions are switched off. The door remains closed at the end of the cooking programme. The cooling fan cools the food and the oven compartment.

If you then want to restart a cooking programme with the **Rapid cooling** function, select the **Rapid cooling | On** setting to switch the function on again.

Keeping warm

Using the **Keeping warm** function you can keep food warm after cooking without inadvertently cooking it further.

The food is kept warm at a preset temperature (see “**Settings – Recommended temps**”).

It is only possible to use the **Keeping warm** function in combination with the **Rapid cooling** function.

This function is not available with the **Steam cooking**  operating mode.

Switching on Keeping warm for a cooking programme

- Select the **Keeping warm | On** setting before selecting the desired function.

When the **Rapid cooling** function is also switched off, “**Keeping warm**” requires the “**Rapid cooling**” function. “**Rapid cooling**” will also be activated. **will appear**.

- If necessary, confirm the message with **OK**.

The **Keeping warm** and **Rapid cooling** functions are switched on. Once the cooking programme has finished, the door opens a little automatically. The cooling fan cools the food and the oven compartment quickly to the preset temperature.

Once this temperature is reached, the door closes again automatically in order to keep the food warm.

If you then want to restart a cooking programme without the **Keeping warm** function, select the **Keeping warm | Off** setting to switch the function off again.

The setting for the **Rapid cooling** function remains unchanged.

Using Steam cooking

In the Steam cooking  operating mode you cook the food using steam only (see "Operating principles – Drawing in water").

In contrast to the Moisture Plus  operating mode, a larger quantity of water is drawn in and steam is continuously injected into the oven compartment at a maximum temperature of 100 °C.

Food is **not** browned during this process.

Useful tip: Keep the door closed during the cooking process so that steam does not escape.

Please refer to the relevant instructions in "Cleaning and care – Evaporate res. moisture".

Suitable food

Steam cooking retains the actual flavour of the food better than conventional cooking. We therefore recommend not seasoning the food with salt, or at least waiting until after the food is cooked. The food also keeps its fresh, natural colour.

- **Vegetables** are very well suited to steam cooking, and in particular to blanching. Almost all vitamins and minerals are retained as the food is not immersed in water.
- **Rice** is cooked in liquid and absorbs all the liquid during the cooking process so that none of the nutrients are lost. Preparing **milk rice** is very easy as there is no need to stir it and the base will not burn.

- When cooking **egg-based dishes** (e.g. custard royale, crème brûlée or soufflés), the cooking result is very even and fine pored.

Cooking containers

Choose suitable cooking containers for each type of food (see "Features – Accessories supplied and available to order").

Use perforated cooking containers for steam cooking if possible. The steam can reach the food from all sides and the food is cooked evenly.

Your own containers

You can also use your own containers. However, please note the following:

- **Always** place the universal tray on shelf level 1 to catch any liquid. Place the containers on the rack or in a suitable container on shelf level 3.
- Containers must be suitable for use in an oven and able to withstand steam. With plastic containers, please check with the manufacturer that they are suitable for use in a steam oven.
- Thick-sided containers made from porcelain, ceramic, or stoneware are not very suitable for using with steam. Due to their thick sides, they do not conduct heat well and as a result cooking durations will be considerably longer than those given in the charts.
- Ensure that there is a gap between the upper rim of the container and the top of the cooking compartment to allow sufficient steam into the container.

Steam cooking

Frozen

The heating-up phase for frozen food is longer than for fresh food. The greater the quantity of frozen food, the longer the heating-up phase.

Cooking with liquid

When cooking with liquid, only fill the cooking container $\frac{2}{3}$ full to prevent the liquid spilling when the cooking container is removed from the oven.

Notes on the cooking charts

You can find the cooking charts at the end of this book.

Shelf level

Always place the universal tray on shelf level 1 to catch any liquid.

Place the rack or cooking container on level 3.

Always insert cooking containers, the rack and the tray between the rails of the shelf runners so that they cannot tip.

Temperature

During steam cooking, the temperature does not exceed 100 °C. Almost all foods can be cooked at this temperature. Some types of food, such as berries, need to be cooked at lower temperatures to prevent them from bursting.

Duration

During steam cooking, the cooking duration does not begin until the set temperature is reached.

In general, the cooking durations for cooking with steam are the same as for cooking food in a saucepan. More information about any factors which may affect the cooking duration is given in the relevant sections.

The quantity of food does not affect the cooking duration. 1 kg of potatoes will take the same time to cook as 500 g of potatoes.

Vegetables

Fresh

Prepare fresh vegetables in the usual way, i.e. wash, clean and cut them up.

Frozen food

Frozen vegetables do not need to be defrosted beforehand. Exception: the vegetables have been frozen together in a block.

Frozen and fresh vegetables which take the same length of time to cook can be cooked together.

If vegetables have frozen together in clumps, break these up before cooking with steam. Follow the manufacturer's instructions on the packaging regarding cooking duration.

Cooking containers

When each piece of the food being cooked only has a small diameter (e.g. peas, asparagus), there are no or very few gaps and the steam can hardly penetrate the food. To ensure even cooking, use a flat cooking container for these types of food and make sure that the food is piled no more than 3–5 cm high. Divide larger amounts of food over several flat cooking containers.

Different types of vegetables which take the same length of time to cook can be cooked together in one cooking container.

Vegetables that need to be cooked in liquid, e.g. red cabbage, must be put in solid cooking containers.

Shelf level

If you cook vegetables that could stain other food in an unperforated cooking container, e.g. beetroot, do not put any other food underneath. This avoids any transfer of colour to other food by preventing liquid dripping onto food below it.

Cooking duration

The cooking duration depends on the size of the food and how well cooked you want it, just as it does with conventional cooking methods.

Example:

Firm potatoes, cut into quarters:

approx. 25 minutes

Firm potatoes, cut in half:

approx. 30 minutes

Fish

Fresh

Prepare fresh fish in the usual way, i.e. clean, gut and fillet.

Frozen

Fish does not need to be fully defrosted before cooking. Defrost so that the surface is sufficiently thawed to take herbs and seasoning. Depending on the thickness of the fish, 2–5 minutes should be enough.

Preparation

Add some lemon or lime juice to fish before cooking. The citric acid helps the flesh stay firm.

It is not necessary to season fish when cooking with steam as this method retains the minerals which give the fish its unique flavour.

Cooking containers

If using a perforated container, grease it first or line it with baking paper.

Shelf level

When cooking fish in a perforated container at the same time as cooking other types of food in other containers, place the container with the fish directly above the universal tray to catch any liquid and so avoid any transfer of tastes to other food.

Temperature

85 °C – 90 °C

For gently cooking delicate types of fish, such as flounder.

100 °C

For cooking firmer types of fish, e.g. salmon.

Also for cooking fish in sauce or stock.

Steam cooking

Duration

The cooking duration depends on the thickness and the texture of the fish, and not on the weight. The thicker the fish, the longer the cooking duration. A 3 cm thick piece of fish weighing 500 g will take longer to cook than a 2 cm thick piece of fish weighing 500 g.

The longer fish cooks, the firmer its flesh will become. Use the cooking durations given in the chart. If you find that the fish is not cooked sufficiently, only cook it for a few minutes more.

When cooking fish in sauce or stock, we recommend that you increase the cooking duration quoted by a few minutes.

Useful tips

- Adding herbs and spices, such as dill, will help bring out the full flavour of the fish.
- Cook large fish in the swimming position. To help maintain the structure of the fish, place a small cup or similar upside down in the cooking container. Arrange the fish bellysides down over the cup.
- You can use any fish scraps, e.g. fish heads, bones, tails etc. to make a **fish stock**. Place the fish scraps together with some mixed vegetables in a solid cooking container and add cold water. Cook at 100 °C for 60 minutes. The longer the cooking duration, the stronger the stock.
- Preparing fish **au bleu** is a method involving cooking the fish in water with vinegar, at different proportions depending on the recipe. It is important not to damage the skin of the fish. This method is suitable for cooking trout, tench, eel and salmon.

Meat

Fresh

Prepare the meat in the usual way.

Frozen food

Meat should be thoroughly defrosted before cooking (see “Special applications” – “Defrost”).

Preparation

Meat which needs to be seared before being cooked, e.g. stewing steak, should be seared in a pan on the cooktop.

Duration

The cooking duration depends on the thickness and the texture of the meat, and not on the weight. The thicker the piece of meat, the longer the cooking duration. A piece of meat weighing 500 g which is 10 cm thick will take longer to cook than a piece of meat weighing 500 g which is 5 cm thick.

Useful tips

- To retain the **flavourings**, use a perforated cooking container. You can use the concentrate that collects in the universal tray to enhance your sauces or freeze it for later use.
- Boiling chicken, back or top rib and meat bones can be used to make **stock**. Place the meat together with the bones and some mixed vegetables in a cooking container and add cold water. The longer the cooking duration, the stronger the stock.

Rice

Rice swells when cooked and needs to be cooked in liquid. The proportion of rice to liquid will vary depending on the type of rice.

The rice absorbs all the liquid during the cooking process so that none of the nutrients are lost.

Grains

Grains swell when cooked and need to be cooked in liquid. The proportion of grains to liquid depends on the type of grain.

Grains can be cooked whole or cracked.

European dumplings

Dry pasta and noodles

Dry pasta and noodles swell when they are cooked and need to be cooked in liquid. The liquid must cover the pasta or noodles. Using hot liquid gives better results.

Increase the cooking time stated by the manufacturer by approx. 1/3.

Fresh food

Fresh pasta and noodles, such as those you can buy from the supermarket chilled counter, do not need to absorb water. Cook in a greased, perforated container.

Separate any pieces of pasta or noodles which have stuck together and spread them out in the cooking container.

Fruit

To ensure that no juice is lost, cook fruit in a solid cooking container.

If you cook fruit in a perforated cooking container, catch the juice in the universal tray.

Useful tip: You can use the collected juice to prepare a glaze for a fruit flan.

Moisture Plus

Using Moisture Plus

In the Moisture Plus  operating mode you can bake, roast or cook food by using a combination of oven compartment heating and moisture injection (see "Main and sub-menus" and "Operating principles - Drawing in water").

The water that is drawn in is distributed throughout the oven compartment during the cooking process via 1 to 3 bursts of steam. The food is cooked evenly and, in contrast to the Steam cooking  operating mode, is browned due to the higher temperatures used.

It is normal for condensation to form on the inside of the door during a burst of steam. This will evaporate during the course of the cooking programme.

Please refer to the relevant instructions in "Cleaning and care – Evaporate res. moisture".

Suitable food

One burst of steam takes about 5–8 minutes. The number of bursts of steam and when they are injected will depend on the type of food being cooked:

- **Yeast doughs** will rise better if steam is released at the beginning of the programme.
- **Bread and bread rolls** rise better if steam is released at the start. Injecting a burst of steam at the end of the programme will give the bread and rolls a glistening crust.
- When **roasting meat with a high fat content**, injecting steam at the beginning of roasting will help render the fat.

Additional moisture is not suitable for mixtures which already contain a lot of moisture, such as meringues. These need to dry out during baking.

Useful tip: Use the supplied recipes or the Miele App for reference.

 Danger of injury caused by steam.

Steam can cause scalding. In addition, steam condensing on the control panel will cause the sensors to react more slowly.



Do not open the door during a burst of steam.

If you are baking food such as bread or bread rolls in a pre-heated oven, it is best to release the bursts of steam manually. The first burst of steam should be released as soon as you have placed the food in the oven.

If you select more than one burst of steam, the second burst of steam cannot be released until the temperature in the oven compartment has reached at least 130 °C.

Automatic burst of steam

Once the heating-up phase is completed, the steam is released automatically.

The water will vaporise in the oven compartment.  appears in the display. After the burst of steam,  will disappear.

- Continue cooking until the end of the programme.



1 burst of steam, 2 bursts of steam or 3 bursts of steam

The bursts of steam can be injected manually as soon as  lights up in the display.



Please wait until the heating-up phase is completed to allow the steam to be distributed evenly by the warm air in the oven.

Useful tip: For tips on when to inject the steam, please refer to the recipes in the cookbook supplied with the oven, or to the Miele App. Use the Min. minder  function to remind you when to inject the steam.

- Select the  sensor.

The burst of steam will be released.  will appear in the display and the  sensor light will go out.

- Proceed as described to inject further bursts of steam, as soon as the  sensor lights up.

After the last burst of steam is injected, the  sensor and  disappear from the display.

- Continue cooking until the end of the programme.

Automatic programmes

The wide range of Automatic programmes enable you to achieve excellent results with ease.

Categories

The  Automatic programmes are sorted into categories to provide a better overview. Simply select the appropriate Automatic programme for the type of food you are cooking and follow the instructions in the display.

Please refer to the relevant instructions in "Cleaning and care – Evaporate res. moisture".

Using Automatic programmes

- Select Automatic programmes .

A list will appear.

- Select the desired food category.

The Automatic programmes available for the food type selected will then appear.

- Select the Automatic programme that you want to use.
- Follow the instructions in the display.

Usage notes

- The degree of cooking is represented by a bar with seven segments. You can set the desired degree of cooking using the navigation area.
- When using Automatic programmes, the recipes provided are designed as a guide only. Other similar recipes, including those using different quantities, can be used for the Automatic programme in question.
- After cooking, allow the oven compartment to cool down to room temperature again before starting an Automatic programme.
- When you place food in the hot oven compartment, be careful when opening the door. Hot steam may escape. Step back and wait until the steam has dissipated. Avoid contact with hot steam, and do not touch the hot oven compartment walls. Danger of burning and scalding.
- Some Automatic programmes require a pre-heating phase before food can be placed in the oven. A prompt will appear in the display indicating when this needs to be done.
- Some Automatic programmes require the addition of liquid after a certain cooking duration. You will be prompted by a message in the display when this needs to be done (e.g for adding liquid).
- The duration quoted for Automatic programmes is an estimate. It may increase or decrease depending on the programme. The duration, in particular with meat, will vary depending on the initial temperature of the food.

This section provides information on the following applications:

- Defrost
- Low temperature cooking
- Bottling
- Drying
- Frozen food/Ready meals
- Heating crockery

Defrost

Gentle defrosting of frozen goods means that the vitamins and minerals are generally retained.

- Select Other .
- Select Defrost.
- Alter the recommended temperature if necessary.

Air is circulated throughout the oven compartment to gently defrost the frozen food.



Risk of infection from bacteria.

Bacteria such as salmonella can cause life-threatening food poisoning. It is particularly important to observe food hygiene rules when defrosting fish and meat, and in particular when defrosting poultry.

Do not use the liquid produced during defrosting.

Process the food as required as soon as it has been defrosted.

Useful tips

- Remove the packaging and place the frozen goods on the universal tray or in a suitable bowl or dish.
- Use the universal tray with the rack placed on top of it for defrosting poultry. This way the frozen food will not be lying in the defrosting liquid.
- Meat and poultry need to be fully defrosted before cooking. Fish, on the other hand, can be partially defrosted before cooking. Defrost so that the surface is sufficiently soft to take herbs and seasoning.

Low temperature cooking

Low temperature cooking is ideal for cooking delicate cuts of beef, pork, veal or lamb when a tender result is desired.

First briefly sear the meat all over at a high temperature on the cooktop in order to seal it.

Then place the meat in the pre-heated oven where the low temperature and long cooking duration will cook it to perfection and ensure it is very tender.

The meat will relax. The juices inside will start to circulate evenly throughout the meat to reach the outer layers.

This gives very tender and succulent results.

- Use lean meat which has been correctly hung and trimmed. Bones should be removed before cooking.
- For searing, use a suitable cooking oil or fat that can withstand high temperatures (e.g. clarified butter, vegetable oil).
- Do not cover meat during the cooking process.

Other applications

The cooking duration takes approx. 2–4 hours depending on the weight and size of the meat and how well you want it cooked.

- As soon as the cooking programme has finished, you can carve the meat straight from the oven. It does not need to rest.
- The meat can be left in the oven compartment to keep warm until you serve it. This will not affect results in any way.
- Serve on pre-heated plates with very hot sauce or gravy to prevent it cooling down too quickly. The meat is at the ideal temperature for eating straight away.

Using Conventional Heat

Refer to the information in the cooking charts at the end of this booklet.

Use the universal tray with the rack placed on top of it.

- Place the rack together with the universal tray on shelf level 2.
- Select the Conventional Heat  function and a temperature of 120 °C.
- Pre-heat the oven together with the universal tray and rack for approx. 15 minutes.
- While the oven is pre-heating, sear the meat on all sides on the cooktop.

 Risk of burning due to hot surfaces.

The steam combination oven gets hot during operation. You could burn yourself on the heating elements, the oven compartment, or accessories. Wear oven gloves when placing food in the oven or removing it, and when adjusting oven shelves etc. in a hot oven.

- Place the seared meat on the oven rack.
- Reduce the temperature to 100 °C (see "Cooking charts").
- Continue cooking until the end of the programme.

Bottling

 Risk of infection from bacteria.

The spores of the botulinum bacterium are not sufficiently killed by bottling pulses and meat only once. Toxins may form which can lead to serious poisoning. These spores are only destroyed by reheating the food within 2 days after preserving.

After they have cooled down, **always** reheat pulses and meat a second time within 2 days.

 Risk of injury from increased pressure in sealed tins.

Preserving and heating food in sealed tins will result in an increase in pressure, which can cause them to explode.

Do not use tins for preserving or heating food.

Preparing fruit and vegetables

The instructions are for 6 jars with a capacity of 1 litre each.

Only use special jars for preserving (preserving jars or jars with a screw cap). Only use undamaged jars and rubber rings.

- Rinse the jars with hot water before bottling and fill them up to a maximum of 2 cm below the rim.
- After you have filled the jars with the produce, clean the glass rims with a clean cloth and hot water and then seal the jars.
- Place the universal tray on shelf level 2 and place the closed jars on the tray.
- Select the Fan Plus  function and a temperature of 160–170 °C.
- Wait until bubbles evenly rise in the jars.



Reduce the temperature in time to prevent the contents from boiling over.

Bottling fruit and gherkins

- Set the specified continued warming temperature as soon as bubbles are visible in the jars, then leave the jars in the warm oven for the time specified.

Bottling vegetables

- As soon as bubbles are visible in the jars, set the specified bottling temperature and cook the vegetables for the time specified.
- After bottling, set the specified continued warming temperature, then leave the jars in the warm oven for the time specified.

		
Fruit	—/—	30 °C 25–35 min.
Gherkins	—/—	30 °C 25–30 min.
Beetroot	120 °C 30–40 min.	30 °C 25–30 min.
Beans (green or yellow)	120 °C 90–120 min.	30 °C 25–30 min.

 Bottling temperature and time once bubbles are visible in the jars

 Continued warming temperature and time

Removing the jars after bottling

 Risk of injury caused by hot surfaces.

The jars are very hot after bottling. Wear oven gloves when removing the jars from the oven.

- Take the jars out of the oven.
- Cover the jars with a towel and leave for approx. 24 hours in a draught-free area.
- After they have cooled down, **always** reheat pulses and meat a second time within 2 days.
- Remove the fasteners from the jars and make sure all jars are closed properly when storing them.

Either boil open jars again or store them in a cool place and consume the preserved fruit or vegetables immediately.

- Check the jars during storage. If jars have opened during storage or if the screw cap is bulging and does not make a popping noise when opened, destroy the contents.

Other applications

Drying

Drying is a traditional method of preserving fruit, certain vegetables and herbs.





It is important that fruit and vegetables are ripe and not bruised before they are dried.

- Prepare the food for drying by cutting it up, and peeling and coring it if necessary.
- Distribute the food for drying evenly in a single layer according to size over the rack or the universal tray.

Useful tip: You can also use the perforated Gourmet baking and AirFry tray, if you have one.

- Dry on a maximum of 2 levels at the same time.
Place the food for drying on shelf levels 1+3.
If using the rack and universal tray, place the universal tray below the rack.
- Select Fan Plus .
- Change the recommended temperature and set the drying time.
- Turn the food for drying on the universal tray at regular intervals.

The drying times are longer for whole or halved dried food.

Food		🌡️ [°C]	🕒 [h]
Fruit		60–70	2–8
Vegetables		55–65	4–12
Mushrooms		45–50	5–10
Herbs*		30–35	4–8

 Function, 🌡️ Temperature, 🕒 Drying time,  Fan Plus,  Conventional Heat

*Dry herbs only on the universal tray on shelf level 2 and use the Conventional Heat  function, as the fan is switched on in the Fan Plus function.

- Reduce the temperature if condensation begins to form in the oven.

Removing the dried food

 Risk of injury caused by hot surfaces.

The steam combination oven gets hot during operation. You could burn yourself on the heating elements, the oven compartment, or accessories.

Use oven gloves when removing dried food from the oven.

- Allow the dried fruit or vegetables to cool down after drying.

Dried fruit needs to be completely dry, but also soft and elastic. Juice should not escape when cut.

- Store dried food in sealed glass jars or tins.

Frozen food/Ready meals

Tips for cakes, pizza and baguettes

- Bake cakes, pizza and baguettes on baking paper on the rack.
Do not use the baking tray or the universal tray for frozen foods with a large surface area. The tray could become warped and difficult, or even impossible, to remove from the oven compartment when hot. Additional use will make the warping worse.
- Use the lowest temperature recommended on the packaging.

Tips for oven chips, croquettes and similar items

- These frozen items can be cooked on the baking tray or universal tray.
- Use the lowest temperature recommended on the packaging.
- Turn food several times during cooking.

Preparing frozen food/ready meals

Handling food carefully will help protect your health.

Cakes, pizzas and chips should be cooked until golden, not dark brown.

- Select the function and temperature recommended on the manufacturer's packaging.
- Pre-heat the oven.
- Place the food in the pre-heated oven on the shelf level recommended on the packaging.
- Check the food at the end of the shortest cooking duration recommended on the packaging.

Heat crockery

Use the Fan Plus  function for pre-heating crockery.

Only pre-heat heat-resistant dishes.

- Place the rack on shelf level 1 and place the crockery to be pre-heated on it. Depending on the size of the dishes, you can also place them on the oven floor and take out the shelf runners to make more room.
- Select Fan Plus .
- Set the temperature to 50–80 °C.

 Risk of injury caused by hot surfaces.

The steam combination oven gets hot during operation. You could burn yourself on the heating elements, the oven compartment, or accessories. Droplets of water may have accumulated underneath the crockery.

Wear oven gloves when removing dishes from the oven.

- Remove the heated crockery from the oven.

Baking

Handling food carefully will help protect your health.
Cakes, pizzas and chips should be cooked until golden, not dark brown.

Tips on baking

- Set a cooking duration. When baking, the oven should not be set to start a long time off. Otherwise the cake mixture or dough will dry out, and the raising agents will lose their effectiveness.
- Generally, you can use the rack, baking tray, universal tray and any type of baking tray made of heat-resistant material.
- Avoid using bright, thin-walled tins as they give an uneven or poor browning result. In certain unfavourable conditions, the food will not cook properly.
- Place cakes in rectangular tins on the rack with the longer side across the width of the oven for optimum heat distribution and even results.
- Always place bakeware on the rack.
- Bake cakes with fruit toppings or deep cakes on the universal tray.

Using baking paper

Miele accessories, e.g. the universal tray, are treated with PerfectClean enamel (see “Features”). Surfaces treated with PerfectClean enamel generally do not need to be greased or covered with baking paper.

- Use baking paper when baking lye pastries (e.g. pretzels) because the sodium hydroxide can damage the PerfectClean treated surface.

- Use baking paper when baking sponge, meringue, macaroons or similar items. These are more likely to stick due to their high egg white content.
- Use baking paper when cooking frozen food on the rack.

Notes on the cooking charts

You can find the cooking charts at the end of this book.

Selecting the temperature

- As a general rule, select the lower temperature given in the chart. Baking at temperatures higher than those recommended may reduce the cooking duration, but will lead to uneven browning of the food, and unsatisfactory cooking results.

Selecting the cooking duration

Unless otherwise stated, the cooking durations given in the cooking charts are for an oven compartment which has not been pre-heated. With a pre-heated oven compartment, shorten durations by around 10 minutes.

- As a general rule, check whether the food is cooked after the shortest duration. Stick a wooden skewer into the food.

If it comes out clean without any batter/dough on it, the food is done.

Notes on the oven functions

You can find an overview of all the functions with their recommended values in “Main and sub-menus”.

Using Automatic programmes

- Follow the instructions in the display.

Using Fan Plus

Because the fan distributes the heat around the oven compartment straight away, you can use a lower temperature than you would with the Conventional Heat  function.

Use this function if you are baking on multiple shelf levels at the same time.

- 1 shelf: Place the food on shelf level 2.
- 2 shelves: Place the food on shelf levels 1+3 or 2+4.
- 3 shelves: Place the food on shelf levels 1+3+5.

Useful tips

- If you are cooking on multiple shelf levels at the same time, slide the universal tray in on the lowest level.
- For moist biscuits and cakes, bake on a maximum of 2 shelf levels at once.

Using Moisture Plus

Use this function for cooking with moisture assistance.

- Place the food on shelf level 2.

Using Intensive Bake

Use this function for baking cakes with moist toppings.

Do **not** use this function for baking thin biscuits.

- Place cakes on shelf level 1 or 2.

Using Conventional Heat

Dark metal, enamel, or aluminium bakeware with a matt finish, as well as heat-resistant glass, ceramic, and coated bakeware can be used.

Use this function for baking traditional recipes. If using an older recipe or cookbook, set the oven temperature 10 °C lower than that recommended. This will not change the cooking duration.

- Place the food on shelf level 1 or 2.

Using Eco Fan Heat

Use this function for cooking small amounts of food, e.g. frozen pizzas, bake-off rolls or biscuits, while saving energy.

- Place the food on shelf level 2.

Roasting

Tips for roasting

- You can use any crockery made from temperature-resistant materials, e.g. oven dishes, roasting pans with lid, ovenproof glass dishes, roasting bags, dishes made from earthenware or cast iron, the universal tray, rack and/or grilling and roasting insert (if present) on top of the universal tray.
- **Pre-heating** the oven compartment is only required when roasting beef sirloin joints and fillet. Pre-heating is generally not necessary.
- Use a **closed roasting dish** for roasting meat, such as an oven dish. The meat stays succulent. The oven compartment will also stay cleaner than when roasting on the rack. It ensures that sufficient stock remains for making gravy.
- If you are using a **roasting bag**, follow the instructions on the packaging.
- If you are using the **rack** or an **open roasting dish** for roasting, you can add a little fat or oil to very lean meat or place a few strips of streaky bacon on the top.
- **Season** the meat and place in the roasting dish. Dot with butter or margarine or brush with oil or cooking fat if necessary. For large lean cuts of meat (2–3 kg) and fatty poultry, add about 1/8 l of water to the dish.
- Do not add too much liquid during cooking as this will hinder the **browning** of the meat. Browning only occurs towards the end of the cooking duration. Remove the lid about halfway through the cooking duration if a more intensive browning result is desired.





- At the end of the programme, take the food out of the oven compartment, cover it and leave to **stand** for about 10 minutes. This helps retain juices when the meat is carved.
- For a crisp finish, baste **poultry** 10 minutes before the end of the cooking duration with slightly salted water.

Notes on the cooking charts

You can find the cooking charts at the end of this book.

- Take note of the temperature range, the shelf levels and the timings. These also take the type of cooking container, the size of the meat and cooking practices into account.

Selecting the temperature

- As a general rule, select the lower temperature given in the chart. If higher temperatures than those specified are used, the meat will brown on the outside, but will not be properly cooked through.
- When cooking with Fan Plus , Moisture Plus  or Auto Roast , select a temperature which is approx. 20 °C lower than with Conventional Heat .
- For cuts which weigh more than 3 kg, select a temperature approx. 10 °C lower than that given in the chart. The roasting process will take longer, but the meat will cook evenly through and the skin or crackling will not be too thick.
- When roasting on the rack, set a temperature approx. 10 °C lower than for roasting in a covered oven dish.

Selecting the cooking duration

Unless otherwise stated, the durations given in the cooking chart are for an oven compartment which has not been pre-heated.

- Determine the cooking duration by multiplying the thickness of the roast [cm] with the time per cm [min./cm] stated below, depending on the type of meat:
 - Beef/Venison: 15–18 min./cm
 - Pork/Veal/Lamb: 12–15 min./cm
 - Sirloin joints/Fillets: 8–10 min./cm
- As a general rule, check whether the food is cooked after the shortest duration.

Notes on the oven functions

You can find an overview of all the functions with their recommended values in “Main and sub-menus”.

Use the Bottom Heat  function towards the end of the cooking duration to brown the base of the food.

Do not use the Intensive Bake  function for roasting as the juices will become too dark.

Using Automatic programmes

- Follow the instructions in the display.

Using Fan Plus or Auto Roast

These functions are suitable for roasting meat, fish and poultry that needs to be well browned as well as sirloin joints and fillet.

The Fan Plus  function allows you to use a lower temperature than you would with the Conventional Heat  function,

because the heat is immediately distributed throughout the oven compartment.

With the Auto Roast  function, the oven compartment heats initially to a high searing temperature (approx. 230 °C). As soon as this temperature has been reached, the steam combination oven automatically drops the temperature back down to the pre-selected roasting temperature (continued roasting).

- Place the food on shelf level 2.

Using Moisture Plus

Use this function for cooking with moisture assistance.

- Place the food on shelf level 2.

Using Conventional Heat

Use this function for baking traditional recipes. If using an older recipe or cookbook, set the oven temperature 10 °C lower than that recommended. This will not change the cooking duration.

- Place the food on shelf level 2.

Using Eco Fan Heat

Use this function for cooking smaller roasts or meat dishes in an energy-saving way.

- Place the food on shelf level 2.

Grilling

 Risk of injury caused by hot surfaces.

If you grill with the door open, hot air will escape from the oven instead of being cooled by the cooling fan. The control elements will get hot.

Grill with the oven door closed.

Tips for grilling

- Pre-heating is necessary when grilling. Pre-heat the top heat/grill element for approx. 5 minutes with the door closed.
- Trim the meat if necessary. Season meat 10-15 minutes before cooking.
- Add a little oil to lean meat if necessary. Do not use other types of fat as they can easily burn and cause smoke.
- Clean fish in the normal way. To enhance the flavour, season with a little salt. Fish can also be drizzled with lemon juice.
- Use the universal tray with the rack or the grilling and roasting insert (if present) placed on top. The tray under the insert will collect the meat juices and stop them from burning so that they can be used for making gravy and sauces. To grill, brush the rack or the grilling and roasting insert with oil and then place the food on the rack.

Do not use the baking tray.

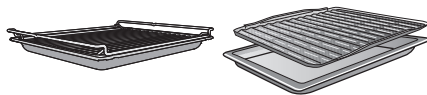

Notes on the cooking charts

You can find the cooking charts at the end of this book.

- Take note of the temperature range, the shelf levels and the timings. These take the size of the meat and cooking practices into account.
- Check the food after the shortest duration quoted.

Selecting the temperature

- As a general rule, select the lower temperature given in the chart. If higher temperatures than those specified are used, the meat will brown on the outside, but will not be properly cooked through.

Choosing a shelf level

- Select the shelf level depending on the thickness of the food to be cooked.
- Place flat food on shelf level 3 or 4.
- Place thicker food on shelf level 1 or 2.

Selecting the cooking duration

- Grill thinner cuts of meat/slices of fish for approx. 6–8 minutes per side. It is best to grill food of a similar thickness at the same time so that the cooking durations do not vary too much.
- As a general rule, check whether the food is cooked after the shortest duration.
- To **test the food**, press down on the meat with a spoon. This lets you determine how well the meat has been cooked.
 - **Rare**
If the meat gives easily to the pressure of the spoon, it will still be red on the inside.
 - **Medium**
If there is some resistance, the inside will be pink.
 - **Well-done**
If there is great resistance, it is cooked through.

Useful tip: If the surface of a thicker cut of meat is browned but the centre is still raw, move the food to a lower level or reduce the temperature and continue grilling. This will stop the surface from becoming excessively charred.

Notes on the oven functions

You can find an overview of all the functions with their recommended values in “Main and sub-menus”.

Using Full Grill

Use this function to grill flat thin cuts in large quantities and for browning large baked dishes.

The entire top heat/grill element will get hot and glow red.



Using Fan Grill

This function is suitable for grilling thicker food, such as chicken.



A temperature setting of 220 °C is generally recommended for thinner types of food, while 180–200 °C is recommended for thicker cuts.

Grilling

Fan Grill

- Use the Fan Grill  function for meat, fish, poultry and vegetables.
- Always pre-heat for at least 5 minutes before Fan Grilling.
- It is not necessary to turn food when Fan Grilling . Only one side of the food, however, will become brown.
- The door must be closed when using Fan Grill .
- When using red meat, pat the meat dry before Fan Grilling as this encourages a richer colour.

All temperatures are approximations and must be varied according to the thickness and preparation of the meat. The chart below is a suggested guide only. Personal taste and size of serves will vary times and temperatures. We recommend you monitor cooking results for best outcomes.

Food to be grilled	 [°C]	 5 1	 [min.]
Lean thin sausages	180	4	8–10
Thick sausages	180	4	15–20
Lean beef fillet steak	220	5	6–12
Chicken breast fillet	200	4	14–18
Whole butterflied chicken	200	3	30–35
Thin white fish fillets	220	5	6–10
Thick fish fillets, cutlets or steaks	200	4	10–15
Oily fish	200	4	8–12
Lamb loin chops	190	4	12–16
Lamb back straps	220	5	8–10
Vegetables, capsicum, zucchini, sweet potato, eggplant	200	5	12–15
Potato wedges or small roast potatoes	220	3	20–25
Kebabs and satays (red meat)	200	5	12–15
Chicken satays	200	4	12–15

 Temperature /  Shelf level /  Duration

Fan Grill  can be used for small roasts but is only recommended for lean, tender cuts of meat, e.g. lamb racks, rump roasts, and beef fillet. Fan Grill the roast at 200 °C on shelf level 3 for approximately 25 minutes, depending on thickness.

Grill

- Use Grill  for thick toasts, muffins, cheese on toast, focaccia, bruschetta and bacon.
- Pre-heat the grill for at least 5 minutes at 200–220 °C.
- Select the appropriate shelf level for the thickness of the food.
- The door must be closed when using the Grill function.

This is a suggested guide only. Personal taste and size of serves will vary times and temperatures.

Cleaning and care



Risk of injury caused by hot surfaces.

The steam combination oven gets hot during operation. You could burn yourself on the heating elements, the oven compartment, or accessories.

Allow the heating elements, oven compartment and the accessories to cool before manual cleaning.



Risk of injury due to electric shock.

The steam from a steam cleaning appliance could reach electrical components and cause a short circuit.

Never use a steam cleaner for cleaning.

All surfaces could be discoloured or damaged if unsuitable cleaning agents are used. The front of the steam combination oven is particularly susceptible to damage from oven cleaners or descaling agents.

All surfaces of this appliance are susceptible to scratching. Scratches on glass surfaces could cause a breakage in certain circumstances.

Remove all cleaning agent residues immediately.

Unsuitable cleaning agents

To avoid damaging the surfaces of your appliance, do not use:

- cleaning agents containing soda, alkalines, ammonia, acids or chlorides
- cleaning agents containing descaling agents on the front
- abrasive cleaning agents, e.g. powder cleaners and cream cleaners

- solvent-based cleaning agents
- stainless steel cleaning agents
- dishwasher cleaners
- glass cleaning agents
- cleaning agents for ceramic cooktops
- hard, abrasive brushes or sponges, e.g. pot scourers, brushes or sponges which have been previously used with abrasive cleaning agents
- dirt eraser sponges
- sharp metal scrapers
- steel wool or metal scourers
- spot cleaning with mechanical cleaning agents
- oven cleaner
- stainless-steel spiral pads

If soiling is left on for any length of time, it may become impossible to remove. Continued use without regular cleaning will make the oven much harder to clean. Failure to maintain the oven in a clean condition could lead to deterioration of the surfaces that could adversely affect the life of the appliance and result in a hazardous situation.

Remove any soiling immediately.

The accessories are not dishwasher-safe (exception: cooking containers).

Useful tip: Soiling caused by spilled fruit juices and cake mixtures is best removed while the oven is still warm. Exercise caution and make sure the oven is not too hot.

To make it easier to clean the oven:

- Remove the door.
- You can remove the shelf runners together with the FlexiClip telescopic runners (if present).
- Remove the catalytic enamelled back panel.

Removing normal soiling

Useful tip: Cleaning is made easier when you use the Other  | Maintenance | Soak programme (see "Maintenance").

- Use a sponge or soft cloth to remove any condensation in the oven compartment and drip channel.
- It is best to remove normal soiling immediately using a clean sponge and a solution of hot water and washing-up liquid, or a clean, damp microfibre cloth.
- Remove any residual cleaning agent thoroughly with clean water. This is particularly important for any parts with a PerfectClean finish, as cleaning agent residues will impair the non-stick properties.
- After cleaning, wipe the surfaces dry using a soft cloth.

Cleaning the seal

There is a seal around the oven interior to seal it off from the inside of the door.

Grease deposits on the seal can cause it to become brittle and cracked.

- It is advisable to wipe the seal clean after each use.

If the seal is not inserted correctly, steam may escape from the oven compartment during cooking.

Never remove the seal.

Cleaning cooking containers

The cooking containers are suitable for cleaning in the dishwasher.

- Wash and dry the cooking containers after each use.
- Any bluish discolouration on cooking containers can be removed with vinegar. Rinse with clean water.

Removing stubborn soiling (excluding the FlexiClip telescopic runners)

Spilled fruit and roasting juices may cause lasting discolouration or matt patches on surfaces. This discolouration will not affect the functional characteristics of the surface finish.

Do not attempt to remove these marks. Clean them following the instructions given here.

- Baked-on deposits can be removed with a glass scraper or with a stainless steel spiral pad, hot water and washing-up liquid.

Useful tip: Cleaning is made easier when you use the Other  | Maintenance | Soak programme (see "Maintenance").

Exposure to scouring agents, abrasive brushes or sponges and oven sprays can cause catalytic enamel to lose its self-cleaning properties.

Remove the catalytic enamelled panels before using an oven cleaner.

Cleaning and care

Using oven cleaners

- Very stubborn soiling on PerfectClean surfaces can be cleaned using Miele Oven Cleaner. This cleaner must only be applied to cold surfaces.

If the oven spray gets into gaps and openings, a strong odour is generated during subsequent cooking programmes.

Do not spray the oven cleaner onto the roof of the oven compartment.

Do not spray the oven cleaner into the gaps and openings of the oven compartment walls and rear wall.

- Follow the instructions on the packaging.

Oven cleaners from other manufacturers must only be used in a cold oven and must not be left on for longer than 10 minutes.

- If necessary, the scouring pad on the back of a non-scratching washing-up sponge can be used to remove the soiling after the soaking time.
- Remove any residual cleaning agent thoroughly with clean water.
- Dry all surfaces with a soft cloth.

Stubborn soiling on the FlexiClip telescopic runners

Do not clean FlexiClip telescopic runners in a dishwasher. The special lubricant used in the telescopic runners will wash out during dishwashing.

This will affect their smooth functioning.

For stubborn surface soiling or if the bearings become sticky, proceed as follows:

- Soak the FlexiClip telescopic runners briefly (approx. 10 minutes) in a solution of hot water and dishwashing liquid.

If necessary, the scouring pad on the back of a non-scratching dishwashing sponge can be used to remove the soiling. You can clean the bearings with a soft brush.

The runners may appear discoloured or a lighter colour in places after they have been cleaned. This will not affect the functioning of the runners in any way.

Cleaning the catalytic enamelled back panel

Catalytic enamel is self-cleaning, which means that soiling from oil and fat is burnt off automatically when very high temperatures are reached inside the oven. You do not need to use any additional cleaning agent. The higher the temperature, the more effective the process.

Exposure to scouring agents, abrasive brushes or sponges and oven sprays can cause catalytic enamel to lose its self-cleaning properties.

Remove the catalytic enamelled panels before using an oven cleaner in the oven compartment.

Removing soiling caused by spices, sugar and similar deposits

- Remove the back panel (see “Cleaning and care – Removing the back panel”).
- Clean the back panel by hand with a solution of hot water and washing-up liquid applied with a soft brush.
- Rinse the back panel thoroughly.
- Let the back panel dry before placing it back in the oven.

Removing oil and grease soiling

- Remove all accessories from the oven, including the shelf runners.
- Wipe large deposits of soiling from the inside of the door and the PerfectClean enamelled surfaces before starting the catalytic cleaning process to avoid them baking on.
- Select the Fan Plus  function and 250 °C.
- Then heat the empty oven for at least 1 hour.

The length of time required will depend on the degree of soiling.

If the catalytic enamel is very heavily soiled with oil and grease, a film can form on the surfaces of the oven interior during the cleaning process.

 Risk of injury caused by hot surfaces.

The steam combination oven gets hot during operation. You could burn yourself on the heating elements and the oven interior.

Allow the heating element and oven compartment to cool before manual cleaning.

- Clean the inside of the door and the oven compartment with a solution of hot water and washing-up liquid, applied with a clean sponge, or a clean, damp microfibre cloth.

Any remaining soiling will gradually disappear with each subsequent use of the oven at high temperatures.

Cleaning the oven ceiling

Clean the oven ceiling regularly to remove any food residues.

 Risk of injury caused by hot surfaces.

The steam combination oven gets hot during operation. You could burn yourself on the heating elements, the oven compartment, or accessories.

Allow the heating elements, oven compartment and the accessories to cool before manual cleaning.

The steam combination oven may get damaged if steam is able to penetrate the lamp cover. Do not operate the steam combination oven without the lamp cover securely in place.

Use caution not to damage the top heat/grill element.



Do not use force to lower the top heat/grill element as this can cause it to break.

- Clean the ceiling of the oven compartment with a clean sponge and a solution of hot water and washing-up liquid or a clean, damp microfibre cloth.

Cleaning and care

Evaporate res. moisture

When cooking with steam or moisture injection, residual water can remain in the steam injection system, e.g. if a cooking process with moisture injection is carried out manually or if there is a power failure.

The next time Steam cooking , Moisture Plus  or an Automatic programme with moisture is used, Evaporate res. moisture will appear in the display.

- It is best to start the evaporation of residual water straight away so that only fresh water is used during the next cooking programme, and so that the steam injection system does not overflow when more water is drawn in.

 Danger of injury caused by steam.

Steam can cause scalding.
Do not open the door while the residual moisture is being evaporated.

The time it takes for the residual water to evaporate varies depending on the amount of water.

The oven compartment is heated up and the remaining water is evaporated, causing condensation to form in the oven compartment and on the door.

- This condensation needs to be wiped off the door and the oven compartment once the oven has cooled down.

Starting residual moisture evaporation immediately

 Danger of injury caused by steam.

Steam can cause scalding.
Do not open the door during a burst of steam.

- Select an oven function or an Automatic programme that uses the addition of moisture.

The Evaporate res. moisture query will appear.

- Confirm with *OK*.

A time will be displayed.

The residual moisture evaporation process will start. You can follow the time counting down in the display.

The time shown in the display will depend on the amount of residual water left in the system. During the evaporation process, the duration may be adjusted by the system according to the actual amount of water present.

At the end of the residual water evaporation process, a buzzer will sound and *Finished* will appear.

A cooking programme with a function or an Automatic programme that uses moisture can now be run.

While the residual water is evaporating, the moisture will condense on the door and in the oven interior. This moisture needs to be wiped off after the oven has cooled down.

Skipping residual moisture evaporation

 Risk of infection due to contaminated water in the water container.

Skipping residual water evaporation can cause germs to form in the water container. This contaminated water could be injected onto the food during the next cooking process. It is best to start the evaporation of residual water straight away so that only fresh water is used during the next cooking programme.

Skipping the residual moisture evaporation process can, in certain cases, cause water to overflow into the oven compartment.

It is best not to cancel the evaporation process.

- Select an oven function or an Automatic programme that uses the addition of moisture.

Evaporate res. moisture appears in the display.

- Select Skip.

A cooking programme with a function or an Automatic programme that uses moisture can now be run.

You will be prompted to carry out the evaporation of residual water again the next time you select an operating mode or an Automatic programme with moisture and when you switch the steam combination oven off.

Maintenance

Soak

You can use this maintenance programme to soak stubborn soiling.

- Take the accessories out of the oven compartment.
- Remove coarse soiling with a cloth.
- Select Other  | Maintenance | Soak.
- Follow the instructions in the display.

 Risk of injury due to hot steam.

At the end of the maintenance programme, a lot of hot steam can escape when the door is opened. The steam can cause burns.

Step back and wait until the hot steam has dissipated.

- Once soaking is complete, **immediately** remove the water and condensate from the oven compartment and drip channel using a sponge or soft cloth.
- Then dry the oven compartment and the inside of the door with a cloth.

Useful tip: Once you have run the Soak maintenance programme, we recommend that you run the Drying maintenance programme to also remove moisture from inaccessible areas of the oven compartment.

Cleaning and care

Drying

You can use this maintenance programme to dry any residual moisture in the oven compartment, including in inaccessible areas, and protect the oven against corrosion.

The Drying maintenance programme consists of up to 3 phases: residual water evaporation in the empty oven compartment, drying by heating up the oven compartment and rapid cooling with the door slightly open.

 Risk of infection due to contaminated water in the water container.

Germs can form in the water container if you do not run the Drying maintenance programme. This contaminated water could be injected onto the food during the next cooking process.

Run the Drying maintenance programme to ensure that all residual water fully evaporates.

- Select Other  | Maintenance | Drying.
- Select whether you want to start the drying cycle immediately or later and confirm with *OK*.
- Follow the instructions in the display.
- Use a sponge or soft cloth to remove any water and condensation in the oven compartment and drip channel.
- If the Drying maintenance programme has finished, switch off the steam combination oven.

Descale

The frequency of descaling will depend on how often you use the Moisture Plus function.

The descaling process can be run at any time.

However, to ensure that the oven functions correctly, you will be automatically prompted to run the descaling process for the steam injection system after a certain number of programmes.

The oven will count down in the display the last 10 programmes that can be run before it needs to be descaled. You will then not be able to run any function, Automatic programme or Maintenance programme using moisture.

These functions can only be used again after you have carried out the descaling process. All other functions, Automatic programmes and Maintenance programmes without moisture can still be used.

Descaling process sequence

Once the descaling process has been started it must be completed through to the end. It cannot be cancelled.

The descaling process takes approx. 140 minutes and consists of several steps:

1. Preparing the descaling process
2. Drawing in the descaling solution
3. Activation phase
4. Rinse 1
5. Rinse 2
6. Rinse 3
7. Evaporating the residual water and drying the oven compartment

Preparing the descaling process

You will need a container of approx. 1 litre capacity.

A plastic tube (with suction cup) is supplied with your oven so that you do not have to hold the container with the descaling agent underneath the water intake pipe.

We recommend using the descaling tablets supplied. They have been specially developed for Miele appliances for optimum cleaning results.

Useful tip: Miele descaling tablets are available to order from the Miele online shop or directly from Miele.

Other descaling agents, which contain other acids besides citric acid and/or other undesirable substances, such as chlorides, could cause damage.

Moreover, the descaling result required could not be guaranteed if the descaling solution was not of the appropriate concentration.

- Fill the container with approx. 900 ml of cold fresh water and thoroughly dissolve two descaling tablets in it.

Starting the descaling process

- Select Other .
- Select Maintenance.
- Select Descale.

If the functions and Automatic programmes that use moisture injection are already disabled, the descaling process can be started immediately by touching *OK*.

- Place the universal tray on the top shelf level to collect the descaling solution after it has been used. Confirm the message shown with *OK*.

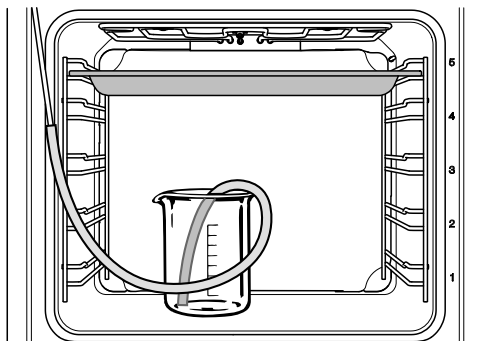

- Attach one end of the plastic tube to the water intake pipe.
- Place the container with the descaling solution on the floor of the oven.
- Place the other end of the plastic tube in the bottom of the descaling agent container and secure the plastic tube to the container with the suction cup.
- Confirm with *OK*.

The water intake process will begin. You will hear the noise of the pump.

You can interrupt and resume the intake process at any time by selecting *OK*.

A message will appear when the intake process is finished.

- Confirm with *OK*.
- Provide 1 l of fresh tap water and follow the instructions in the display.

The **activation phase** will begin. You can follow the duration as it counts down.

- Leave the container with the tube connected to the water intake pipe in the oven compartment.

Cleaning and care

The system will take in liquid several times during the activation phase. You will hear the noise of the pump.

The oven lighting and the cooling fan will remain on during descaling.

A buzzer will sound at the end of the activation phase.

Rinsing the steam injection system after the activation phase

After the activation phase, the steam injection system must be rinsed out with **cold** tap water to remove residues of descaling agent.

Cleaning is carried out by flushing approx. 1 litre of fresh tap water through the system three times. The water is collected in the universal tray.

Rinse the container thoroughly after the first rinse to remove any descaling agent residue.

- Follow the instructions in the display.

After the third rinse, the pump will run for approx. 1 minute to pump the remaining water out of the steam injection steam.

- Follow the instructions in the display.
- Remove the universal tray, container and plastic tube.
- Confirm with *OK*.

The rinsing process is complete.

Evaporating residual moisture

After the third rinse, residual moisture evaporation and the drying process will commence.

- Close the door.

 Danger of injury caused by steam.

Steam can cause scalding.
Do not open the door while the residual moisture is being evaporated.

The oven heating will switch on and the duration of the evaporation process will count down in the display. During the evaporation process, the duration may be adjusted by the system according to how much water is currently present.

Once the residual water has been evaporated, the drying process starts automatically to remove moisture from inaccessible areas of the oven compartment.

Finalising the descaling process

At the end of the evaporation process a message will appear in the display with advice on cleaning after running the descaling programme.

- Confirm with *OK*.

A buzzer sounds and *Finished* appears.

- Use the On/Off  sensor to switch the steam combination oven off.

 Risk of injury caused by hot surfaces.

The steam combination oven gets hot during operation. You could burn yourself on the heating elements, the oven compartment, or accessories.

Allow the heating elements, oven compartment and the accessories to cool before manual cleaning.

- When the oven compartment has cooled down, clean away any descaling agent residues.
- Leave the oven door open until the oven compartment is completely dry.

Removing the door

The door weighs approx. 9 kg.



The oven door is connected to the hinges by retainers. Before removing the door from the retainers, the locking clamps on both hinges have to be released.

- Open the door fully.

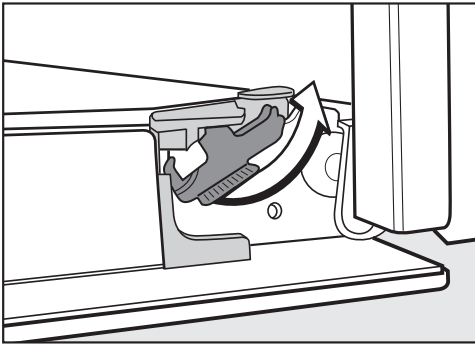

- Release the locking clamps by turning them as far as they will go.

The steam combination oven could become damaged if you incorrectly remove the door.

Never pull the door horizontally off its retainers, as they will spring back against the steam combination oven. Do not pull the door off the retainers by the handle, as the handle could break off.

- Raise the door up till it rests partially open.

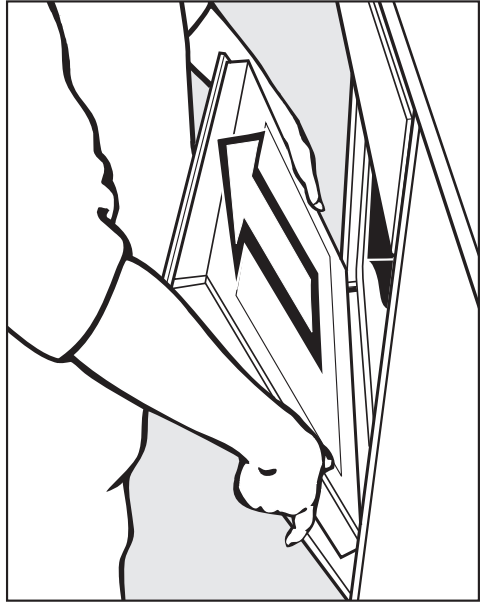

- Hold the door on either side and pull it diagonally upwards from the hinge guides. Make sure that the door is straight.

Cleaning and care

Dismantling the door

The oven door is an open system with 3 glass panes which have a heat-reflective coating on some of their surfaces.

When the oven is operating, air is directed through the door to keep the outer pane cool.

If soiling has worked its way in between the glass panes, the door can be dismantled in order to clean in between the panes.

Scratches on the door glass can cause the glass to break.

Do not use abrasive cleaners, hard sponges, brushes or sharp metal tools to clean the door glass.

When cleaning the door glass, you must also follow the instructions that apply to the front of the steam combination oven.

Oven cleaners will damage the surface of the aluminium profiles.

Only clean these parts with warm water and washing-up liquid applied with a clean sponge, or with a clean, damp microfibre cloth.

The door glass panes can break if dropped.

Keep the disassembled door glass in a safe place.

 Risk of injury caused by the door slamming shut.

The door may slam shut if you attempt to disassemble it when it is fitted to the oven.

Always remove the door before disassembling it.

- Place the door with the outer glass pane on a soft surface (e.g. a tea towel) to prevent it getting scratched. The door handle should line up with the edge of the table so that the glass lies flat and does not get broken during cleaning.

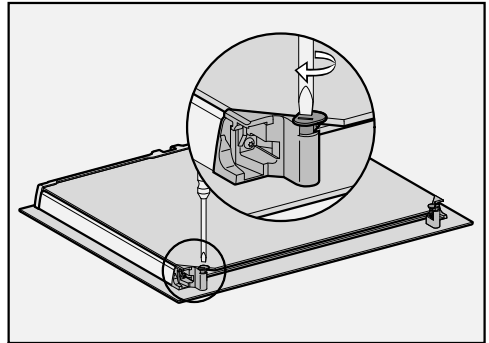

- Use a flat-head screwdriver to flip the two glass pane retainers outwards.

To remove the inner pane:

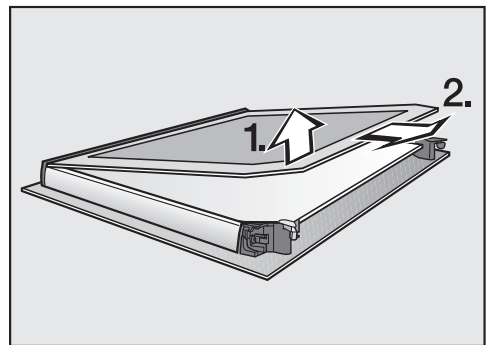

- **Gently** lift the inner pane up and out of the plastic strip.

Cleaning and care



- Lift the middle pane up **gently** and pull it out.
- Clean the door panes and other individual parts with a clean sponge and a solution of hot water and washing-up liquid or a clean, damp microfibre cloth.

- Dry all parts with a soft cloth.

Then reassemble the door carefully.

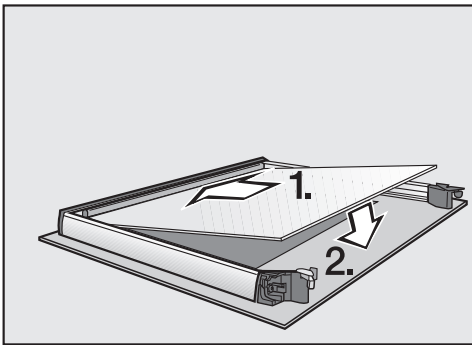

- Refit the middle pane in such a way that the material number is legible (not reversed).

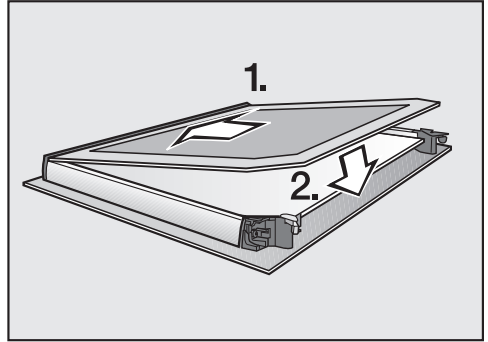

- Push the inner pane with the matt printed side facing downwards into the plastic strip and place it between the retainers.

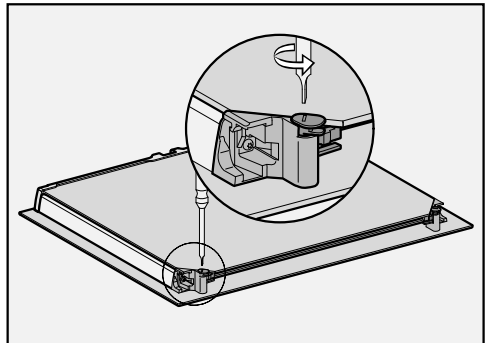

- Use a flat-head screwdriver to flip the two glass pane retainers inwards. The door is now reassembled.

Cleaning and care

Fitting the door

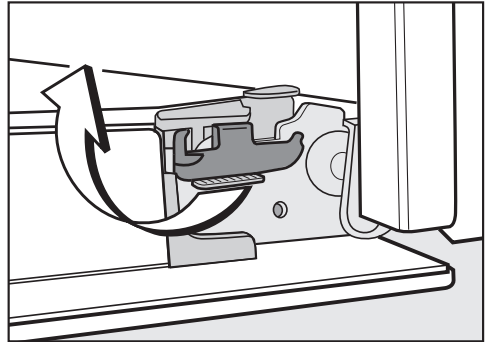
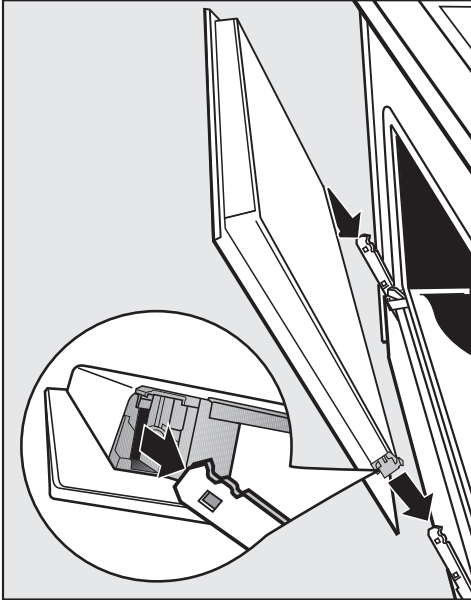

- To relock the locking clamps, flip them back up into a horizontal position as far as they will go.

- Hold the door securely on both sides and carefully fit it back onto the hinge retainers. Make sure that the door goes back on straight.
- Open the door fully.

If the locking clamps are not locked, the door could work loose resulting in damage.

Ensure that the locking clamps are locked after refitting the door.

Removing the shelf runners with FlexiClip telescopic runners

You can remove the shelf runners together with the FlexiClip telescopic runners (if present).

If you wish to remove the FlexiClip telescopic runners separately beforehand, please follow the instructions in "Features – Fitting and removing the FlexiClip telescopic runners".

 Risk of injury caused by hot surfaces.

The steam combination oven gets hot during operation. You could burn yourself on the heating elements, the oven compartment, or accessories. Allow the heating elements, oven compartment and the accessories to cool before removing the shelf runners.

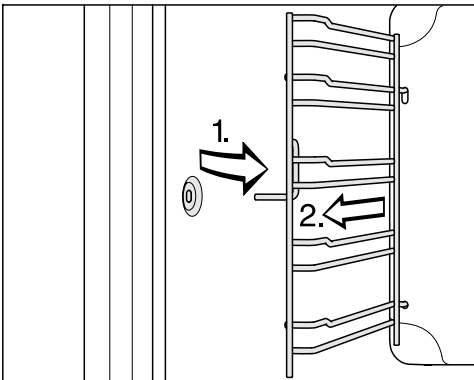

- Pull the shelf runners out of the holder (1.) at the front of the oven and then pull them out of the oven (2.).

Refit in the reverse order.

- Ensure that all parts are correctly fitted.

Removing the back panel

The back panel can be removed for cleaning purposes.

 Risk of injury caused by hot surfaces.

The steam combination oven gets hot during operation. You could burn yourself on the heating elements, the oven compartment, or accessories. Allow the heating element, oven compartment and the accessories to cool before removing the back panel.

 Risk of injury caused by the rotating fan impeller.

You could injure yourself on the impeller of the hot air fan.

Never operate the steam combination oven without the back panel in place.

- Disconnect the steam combination oven from the mains electricity supply. Switch off at the wall and withdraw the plug from the socket, or switch off at the mains circuit breaker.
- Remove the shelf runners.
- Undo the four screws in the corners of the back panel and take it out.
- Clean the back panel (see "Cleaning and Care – Cleaning the catalytic enamelled back panel").

Refit in the reverse order.

- Refit the back panel carefully.

Make sure the openings are located as illustrated in "Overview".



- Refit the shelf runners.
- Reconnect the steam combination oven to the electricity supply.

Problem solving guide

Many malfunctions and minor faults that can occur in daily operation can be corrected without contacting Miele. This will save you time and money because you will not need a service call.

You can find information on how to remedy faults yourself at www.miele.com.au/service or www.miele.co.nz/service and on the Miele website.

Please note, however, that a call-out charge will be applied to unnecessary service visits where the problem could have been rectified as described in these operating instructions.

Problem	Possible cause and remedy
<p>The display is dark.</p>	<p>You have selected the Time Display Off setting. When the steam combination oven is switched off, the display is dark.</p> <ul style="list-style-type: none"> ■ As soon as the steam combination oven is switched on, the main menu will appear. If you want the time of day to be displayed constantly, select the Time Display On setting. <p>There is no power to the steam combination oven.</p> <ul style="list-style-type: none"> ■ Check that the steam combination oven plug is correctly inserted into the socket and switched on. ■ Check if the circuit breaker has tripped. Contact a qualified electrician or Miele.
<p>The signal tone does not sound.</p>	<p>The buzzers are deactivated or set at too low a volume.</p> <ul style="list-style-type: none"> ■ Switch on the buzzers or increase the volume with the Volume Buzzer tones setting.
<p>The oven does not heat up.</p>	<p>Demo mode is active. You can select menu options in the display and the sensors, but the oven heating does not work.</p> <ul style="list-style-type: none"> ■ Deactivate Demo mode with the Showroom programme Demo mode Off setting.
<p>System lock  appears in the display when the oven is switched on.</p>	<p>The system lock  has been switched on.</p> <ul style="list-style-type: none"> ■ Confirm with OK. <p>Press OK for 6 seconds appears in the display.</p> <ul style="list-style-type: none"> ■ You can deactivate the system lock for a cooking process by touching the OK sensor for at least 6 seconds. ■ If you want to permanently deactivate the system lock, select the Safety System lock  Off setting.

Problem solving guide

Problem	Possible cause and remedy
<p>The sensors do not respond.</p>	<p>You have selected the Display QuickTouch Off setting. When the steam combination oven is switched off, the sensors do not respond.</p> <ul style="list-style-type: none"> ■ As soon as the steam combination oven is switched on, the sensors will respond. If you want the sensors to always respond even when the steam combination oven is switched off, select the Display QuickTouch On setting. <p>The steam combination oven is not connected to the power supply.</p> <ul style="list-style-type: none"> ■ Check that the oven plug is correctly inserted into the socket and switched on. ■ Check if the circuit breaker has tripped. Contact a qualified electrician or Miele. <p>There is a fault with the controls.</p> <ul style="list-style-type: none"> ■ Touch and hold the On/Off  sensor until the display switches off and the steam combination oven restarts.
<p>Power cut appears in the display.</p>	<p>There has been a brief power cut. This has caused the current cooking programme to stop.</p> <ul style="list-style-type: none"> ■ Switch the steam combination oven off and back on again. ■ Restart the cooking programme.
<p>12:00 appears in the display.</p>	<p>The power supply was interrupted for longer than 150 hours.</p> <ul style="list-style-type: none"> ■ Reset the time and date.
<p>Max. op. hours reached appears in the display.</p>	<p>The steam combination oven has been operating for an unusually long time. This has triggered the safety switch-off function.</p> <ul style="list-style-type: none"> ■ Confirm with <i>OK</i>. <p>The steam combination oven is now ready to use again.</p>
<p>Fault and a fault code not listed here appears in the display.</p>	<p>A fault has occurred that you cannot resolve.</p> <ul style="list-style-type: none"> ■ Call Miele.

Problem solving guide

Problem	Possible cause and remedy
<p>The Start at and Finish at functions are not available.</p>	<p>The temperature in the oven compartment is too high, e.g. after a programme has finished.</p> <ul style="list-style-type: none"> ■ Open the door and let the oven compartment cool down. <hr/> <p>These functions are not generally available in maintenance programmes.</p>
<p>This function is not available at the moment appears in the display after selecting the Descale function.</p>	<p>The steam injection system is faulty.</p> <ul style="list-style-type: none"> ■ Call Miele.
<p>Programmes using moisture injection will not take in water.</p>	<p>Demo mode is active. You can select menu options in the display and the sensors, but the steam injection system pump will not work.</p> <ul style="list-style-type: none"> ■ Deactivate demo mode by selecting Settings Showroom programme Demo mode Off. <hr/> <p>The pump for the steam injection system is faulty.</p> <ul style="list-style-type: none"> ■ Call Miele.
<p>A noise can be heard after a cooking process.</p>	<p>The cooling fan remains switched on after a cooking programme (see “Settings – Cooling fan run-on”).</p>
<p>After moving house, the steam combination oven no longer switches from the heating-up phase to the cooking phase.</p>	<p>Altitude affects the boiling point of water. If you move house, the appliance will need to be reset for the new altitude if this differs from the old one by more than 300 m.</p> <ul style="list-style-type: none"> ■ Adapt the boiling temperature to the altitude of the new location (see “Settings – Altitude”).
<p>During operation, an unusually high amount of steam leaks out or steam leaks out from different places to usual.</p>	<p>The door is not closed properly.</p> <ul style="list-style-type: none"> ■ Close the door. <hr/> <p>The door seal is damaged, e.g. cracked, or the door seal is not inserted correctly.</p> <ul style="list-style-type: none"> ■ Call Miele. <hr/> <p>The inner pane is so soiled that the seal is not seated correctly.</p> <ul style="list-style-type: none"> ■ Clean the inner pane (see “Cleaning and care – Dismantling the door”).

Problem solving guide

Problem	Possible cause and remedy
<p>The steam combination oven has switched itself off.</p>	<p>To save power, the steam combination oven switches off automatically if a sensor is not pressed after a certain amount of time or after a cooking process has ended.</p> <ul style="list-style-type: none"> ■ Switch the steam combination oven back on again.
<p>Cakes and biscuits are not cooked properly after the duration given in the cooking chart.</p>	<p>A different temperature from the one given in the recipe has been used.</p> <ul style="list-style-type: none"> ■ Select the temperature required for the recipe. <p>The ingredient quantities used are different from those given in the recipe.</p> <ul style="list-style-type: none"> ■ Check whether you have amended the recipe. The addition of more liquid or more eggs makes a moister mix which would take longer to cook.
<p>The browning of baked goods is uneven.</p>	<p>The wrong temperature or shelf level was selected.</p> <ul style="list-style-type: none"> ■ There will always be a slight unevenness in browning. If browning is very uneven, check whether the correct temperature and shelf level were selected. <p>The material or colour of the baking tin is not suitable for the oven function.</p> <ul style="list-style-type: none"> ■ When using the Conventional Heat  function, light coloured, shiny tins are not as suitable. Dark, matt tins are best for baking.
<p>Rust-like spots appear on catalytic surfaces.</p>	<p>The catalytic cleaning process does not remove spices, sugar and similar deposits.</p> <ul style="list-style-type: none"> ■ Take the catalytic panels out of the oven and remove this type of soiling with a mild solution of hot water and washing-up liquid applied with a soft brush (see “Cleaning and care – Cleaning the catalytic enamelled back panel”).
<p>The FlexiClip telescopic runners do not push in or pull out smoothly.</p>	<p>The bearings in the FlexiClip telescopic runners are not sufficiently lubricated.</p> <ul style="list-style-type: none"> ■ Lubricate the bearings with the special Miele lubricant. <p>Only the special Miele lubricant is designed to withstand the high temperatures in the oven compartment. Other lubricants may harden and stick to the FlexiClip telescopic runners when they are heated. You can obtain the special Miele lubricant from Miele.</p>

Problem solving guide

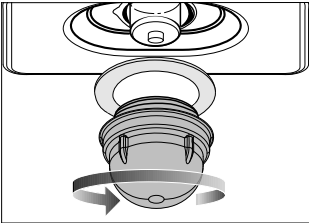
Problem	Possible cause and remedy
<p>The oven lighting switches off after a short time.</p>	<p>You have selected the Lighting “On” for 15 seconds setting.</p> <ul style="list-style-type: none"> ■ If you want the oven lighting to remain switched on during the entire cooking programme, select the Lighting On setting.
<p>The oven lighting does not switch on.</p> 	<p>The halogen lamp is faulty and needs replacing.</p> <div style="border: 1px solid gray; padding: 5px; margin-bottom: 10px;"> <p>⚠ Risk of injury caused by hot surfaces. The steam combination oven gets hot during operation. You could burn yourself on the heating elements, the oven compartment, or accessories. Allow the heating elements, oven compartment and the accessories to cool before manual cleaning.</p> </div> <div style="border: 1px solid gray; padding: 5px; margin-bottom: 10px;"> <p>The steam combination oven may get damaged if steam is able to penetrate the lamp cover. Never use the steam combination oven if the lamp cover is not secured in place.</p> </div> <ul style="list-style-type: none"> ■ Disconnect the steam combination oven from the electrical supply. Switch off at the wall and withdraw the plug from the socket, or switch off at the mains circuit breaker. ■ Unscrew the lamp cover and then pull it together with its sealing ring downwards to take it out. ■ Replace the halogen lamp (Osram 66725 AM/A, 230 V, 25 W, G9). ■ Refit the lamp cover together with its sealing ring. The concave side of the sealing ring must point downwards. ■ Screw in the lamp cover by hand until it is tight. ■ Reconnect the steam combination oven to the electricity supply.

You can find information on how to remedy faults yourself and about Miele spare parts at www.miele.com.au/service or www.miele.co.nz/service.

Contact in case of fault

In the event of any faults which you cannot remedy yourself, please contact Miele.

You can book a Miele customer service call-out online at www.miele.com.au/service or www.miele.co.nz/service.

Contact information for Miele can be found at the end of this booklet.

Please quote the model and serial number of your appliance when contacting Miele. This information can be found on the data plate.

This information is given on the data plate, visible on the front frame of the oven, with the door fully open.

Warranty

The manufacturer's warranty for this appliance is 2 years.

For further information, please refer to your warranty booklet.

Installation

Building-in dimensions

Dimensions are given in mm.

Installation in a tall or base unit

When building the steam combination oven into a base unit underneath a cooktop, please also observe the installation instructions for the cooktop as well as the casing depth required for the cooktop.

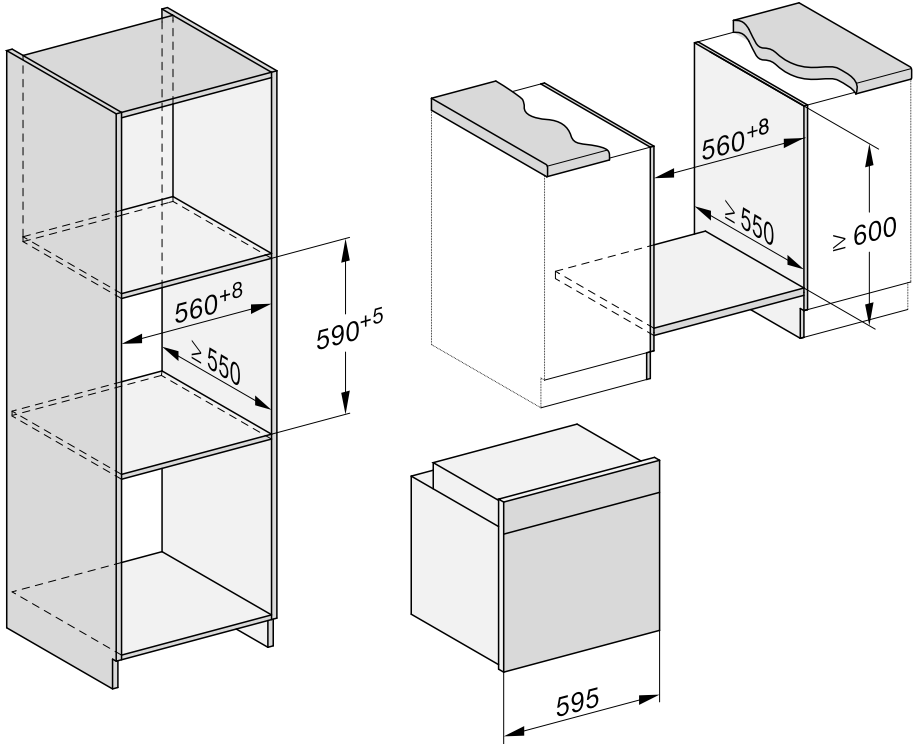

Side view

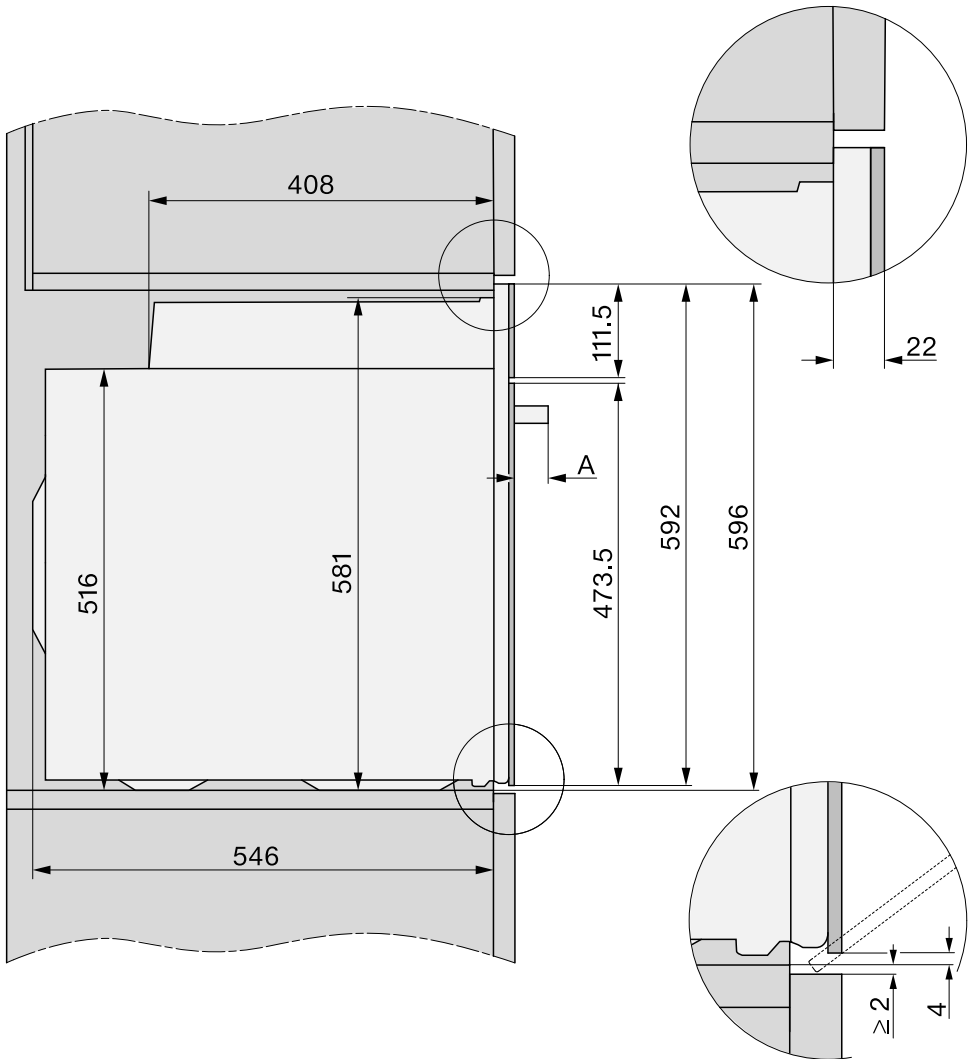

A DGC 725x: 47 mm

Installation

Connections and ventilation

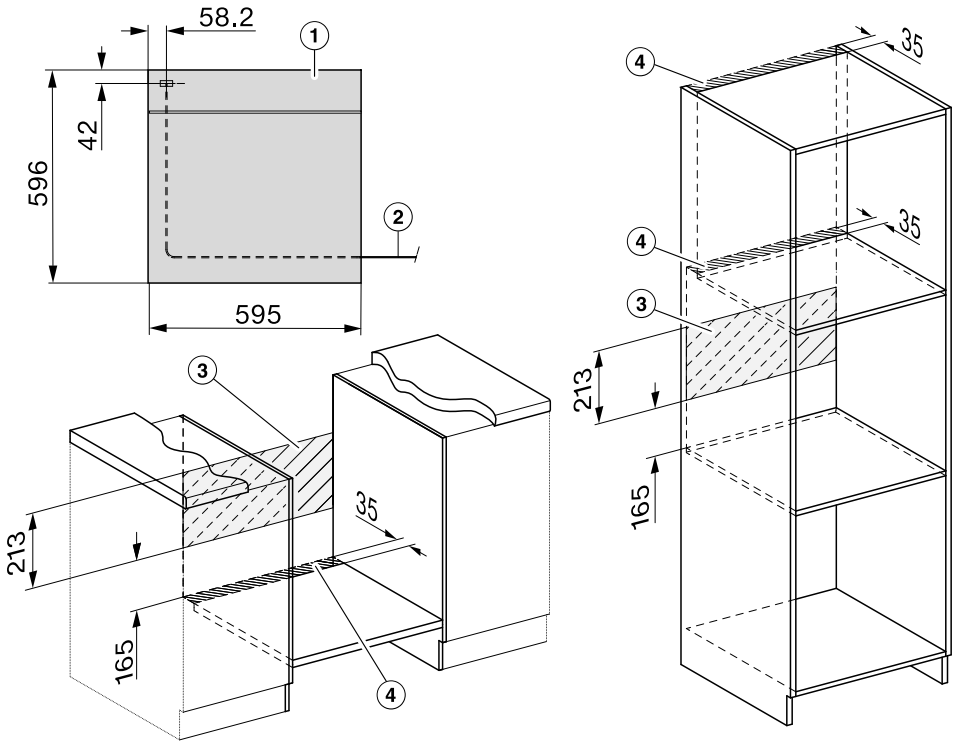

- ① Front view
- ② Mains connection cable, length = 1,500 mm
- ③ No connections permitted in this area
- ④ Ventilation cut-out, min. 150 cm²

Installing the steam combination oven

For safety reasons, the steam combination oven may only be used when it has been fully installed.

The steam combination oven requires a sufficient supply of cool air for efficient operation. The required supply of cool air must not be excessively heated by other heat sources (e.g. solid fuel stoves).

The following must be observed when installing the appliance:

Make sure that the interim shelf that the steam combination oven sits on does not touch the wall.

Do not fit heat insulation strips to the side walls of the housing unit.

- Connect the steam combination oven to the electrical supply.

Carrying the steam combination oven by the door handle could damage the door.

Use the handle cut-outs on the side of the housing to lift the appliance.

It is a good idea to remove the door (see "Cleaning and care – Removing the door") and the accessories before installing the appliance. The steam combination oven is then easier to push into the housing unit and you do not run the risk of lifting it by the door handle.

- Push the steam combination oven into the housing unit and align it.
- Open the door, if you have not removed it.

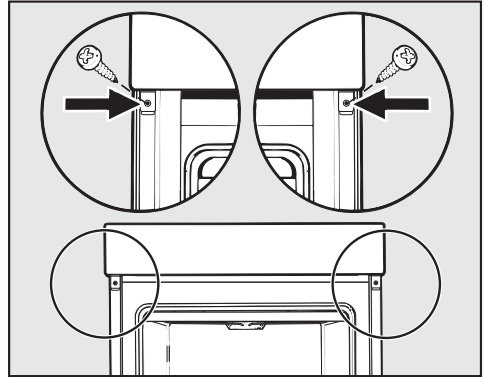

- Use the screws supplied to secure the steam combination oven to the side walls of the housing unit.
- Refit the door, if necessary (see "Cleaning and care – Fitting the door").

Installation

Electrical connection



Danger of injury!

Miele cannot be held liable for unauthorised installation, maintenance and repair work as this can be dangerous to users.

Connection to the electrical mains may only be carried out by a qualified electrician in accordance with national and local regulations and the additional regulations of the local electrical supply companies.

Connection of this appliance must comply with national and local safety regulations.

Connection to a switched socket is recommended as this provides easier access in the case of a service call.

If the appliance is **hardwired** or if the switch is not accessible after installation, an additional means of disconnection must be provided for all poles.

Suitable means of disconnection include switches with an all-pole contact gap of at least 3 mm. These include isolator switches, fuses and relays in accordance with the wiring rules AS/NZS 3000.

Voltage, rated load and fuse rating are given on the data plate situated at the front of the oven compartment. Please ensure the connection data matches the household supply.

When contacting Miele, please quote the following:

- Model number
- Serial number
- Connection data (voltage/frequency/maximum rated load)

If the mains connection cable is damaged, it must be replaced by a suitably qualified electrician with a specialist connection cable of type H 05 VV-F, available from Miele, in order to avoid a hazard.

Temporary or permanent operation with a self-sufficient or non-mains synchronous energy supply system (e.g. isolated networks, back-up systems) is possible. A requirement for the operation is that the energy supply system complies with all current local and national requirements that apply to stand-alone, solar and/or battery systems.

The protective measures provided in the domestic installation and in this Miele product must also be assured in their function and operation in isolated operation or in non-mains synchronous operation, or replaced with equivalent measures in the installation.































Steam combination oven





The steam combination oven is equipped with a 3-core mains connection cable with a plug for connection to a 230 V, 50 Hz alternating current supply.

Fuse rating is 16 A. The appliance must only be connected to a correctly installed safety socket outlet.

Maximum rated load: see data plate.

Vegetables











Vegetables		 [°C]	 5 1	 [min.]
Cauliflower whole		100	3	20–40
Cauliflower florets		100	3	10
Beans, green		100	3	15
Broccoli florets		100	3	6
Peas		100	3	4–6
Fennel halved		100	3	20–28
Fennel cut into strips		100	3	6–8
Kohlrabi cut into batons		100	3	8–10
Pumpkin diced		100	3	4–6
Carrots whole		100	3	7–18
Carrots halved		100	3	7–9
Carrots chopped		100	3	6–10
New potatoes, firm		100	3	28–44
Leeks sliced into rings		100	3	6–10
Romanesco whole		100	3	10–22
Romanesco florets		100	3	7–10
Brussels sprouts		100	3	12–18
Boiled potatoes peeled, whole		100	3	23–40
Boiled potatoes peeled, halved		100	3	20–30
Boiled potatoes peeled, quartered		100	3	16–25
Celeriac cut into batons		100	3	6–10
Asparagus, green		100	3	5–14
Asparagus, white, thick		100	3	13–19
Spinach		100	3	3–4
Savoy cabbage chopped		100	3	12–18
Zucchini sliced		100	3	3–4
Sugar snap peas		100	3	8–10

 Operating mode,  Temperature,  Shelf level,  Cooking duration,  Steam cooking









¹ Use a perforated cooking container and place the universal tray on shelf level 1 to collect the liquid.





Cooking charts

Fish

Fish (fresh or defrosted)		 [°C]	 5 1	 [min.]
Perch fillet		100	3	8–10
Trout		100	3	10–13
Salmon fillet, 3 cm thick		100	3	6–10
Australian salmon		100	3	17–20
Flounder		100	3	8–14
Flounder fillet		100	3	3–5







Meat

Meat		 [°C]	 5 1	 [min.]
Chicken breast fillet		100	3	8–10
Turkey roulade		100	3	12–15
Turkey schnitzel		100	3	4–6
Gammon steaks		100	3	6–10







 Operating mode,  Temperature,  Shelf level,  Cooking duration,  Steam cooking







1 Use a perforated cooking container and place the universal tray on shelf level 1 to collect the liquid.

European dumplings

European dumplings		 [°C]	 5 2	 [min.]
Potato/Bread dumplings, fresh		100	3	15
Potato/Bread dumplings, boil in the bag		100	3	20



















Rice

Rice			 [°C]	 5 2	 [min.]
Basmati rice	1 : 1.5		100	3	15
Parboiled rice	1 : 1.5		100	3	23–25
Milk rice	1 : 2.5		100	3	30–35
Brown rice	1 : 1.5		100	3	25–30

 Ratio of rice to liquid,  Operating mode,  Temperature,  Shelf level,  Cooking duration,  Steam cooking

2 Use a solid cooking container.

Creamed mixture

Cakes/Biscuits (accessories)		Temperature [°C]	Booster 	Shelf level ⁵ ₁		Cooking duration [min.]
				+HFC:	-HFC:	
Muffins (1 tray)		150–160	–	1	2	25–35
Muffins (2 trays)		150–160	–	1+3 ³	1+3	30–40 ⁴
Small cakes (1 tray)		150	–	1	2	28–38
		160 ²	–	2	3	22–32
Small cakes (2 trays)		150 ²	–	1+3 ³	1+3	25–35
Sand cake (rack, loaf tin, 30 cm) ¹		150–160	–	1	2	60–70
		155–165 ²	–	1	2	60–70
Marble, nut cake (rack, loaf tin, 30 cm) ¹		150–160	–	1	2	55–65
		160–170	–	1	2	60–70
Marble, nut cake (rack, ring tin/Bundt cake tin, Ø 26 cm) ¹		150–160	–	1	2	50–60
		150–160	–	1	2	60–70
Fresh fruit cake (1 tray)		150–160	✓	1	2	35–45
		160–170	✓	1	2	45–55
Fresh fruit cake (rack, springform cake tin, Ø 26 cm) ¹		150–160	–	1	2	55–65
		165–175 ²	–	1	2	45–55
Flan base (rack, flan base tin, Ø 28 cm) ¹		150–160	–	1	2	25–35
		170–180 ²	–	1	2	15–25

 Function,  Temperature,  Booster,  Shelf level (+HFC: with FlexiClip telescopic runners HFC 70-C / -HFC: without FlexiClip telescopic runners HFC 70-C),  Cooking duration,  Fan Plus,  Conventional Heat, ✓ On, – Off

- 1 Use a dark coloured, matt baking tin and place it centrally on the rack.
- 2 Pre-heat the oven before placing the food inside.
- 3 Fit the FlexiClip telescopic runners HFC 70-C (if available) onto the bottom shelf level.
- 4 Take the baking trays out of the oven early if the food has already browned sufficiently before the specified cooking time has elapsed.

Cooking charts

Rubbed in mixture

Cakes/Biscuits (accessories)		Temperature [°C]	Booster 	Shelf level ⁵ 		Cooking duration [min.]
				+HFC:	-HFC:	
Cookies (1 tray)		140–150	–	1	2	25–35
		150–160	–	1	2	25–35
Cookies (2 trays)		140–150	–	1+3 ³	1+3	25–35 ⁴
Drop cookies (1 tray)		140	–	1	2	35–45
		160 ²	–	2	3	25–30
Drop cookies (2 trays)		140	–	1+3 ³	1+3	40–50 ⁴
Flan base (rack, flan base tin, Ø 28 cm) ¹		150–160	–	1	2	35–45
		170–180 ²	–	1	2	20–30
Cheesecake (rack, springform cake tin, Ø 26 cm) ¹		170–180	–	1	2	75–85
		160–170	–	1	2	60–70
Apple pie (rack, springform cake tin, Ø 20 cm) ¹		160	–	1	2	90–100
		180	–	1	1	85–95
Apple pie (rack, springform cake tin, Ø 26 cm) ¹		180–190 ²	–	1	2	60–70
		160–170	–	1	2	60–70
Fresh fruit cake, glazed (rack, springform cake tin, Ø 26 cm) ¹		170–180	–	1	2	60–70
		150–160	–	1	2	55–65
Fresh fruit cake, glazed (1 tray)		170–180	–	1	2	50–60
		160–170	–	1	2	45–55
Fruit flan (1 tray)		210–220 ²	✓	–	1	40–50
		190–200	–	–	1	30–40
Scones (2 x aluminium tray on rack, 4 x 4 pieces on each tray)		180–190 ²	–	–	1+3	15–20 ⁴

Function, Temperature, Booster, Shelf level (+HFC: with FlexiClip telescopic runners HFC 70-C / -HFC: without FlexiClip telescopic runners HFC 70-C), Cooking duration, Fan Plus, Eco Fan Heat, Conventional Heat, Intensive Bake, ✓ On, – Off

- 1 Use a dark coloured, matt baking tin and place it centrally on the rack.
- 2 Pre-heat the oven before placing the food inside.
- 3 Fit the FlexiClip telescopic runners HFC 70-C (if available) onto the bottom shelf level.
- 4 Take the baking trays out of the oven early if the food has already browned sufficiently before the specified cooking time has elapsed.

Yeast dough







Cakes/Biscuits (accessories)		Temperature [°C]	Booster 	Shelf level ⁵ ₁		Cooking duration [min.]
				+HFC:	-HFC:	
Bundt cake (rack, Bundt cake tin, Ø 24 cm) ¹		150–160	–	1	2	50–60
		160–170	–	1	2	50–60
Stollen (1 tray)		150–160	–	1	2	55–65
		160–170	✓	1	2	55–65
Streusel cake with/without fruit (1 tray)		160–170	–	2	3	40–50
		170–180	–	2	3	50–60
Fresh fruit cake (1 tray)		160–170	✓	1	2	45–55
		170–180	✓	2	3	45–55
Apple turnovers/raisin scrolls (1 tray)		160–170	✓	1	2	25–35
Apple turnovers/raisin scrolls (2 trays)		160–170	✓	1+3 ³	1+3	30–40 ⁵
White bread, free form (1 tray)		190–200	✓	1	2	30–40 ⁶
		190–200	–	1	2	30–40
White bread (rack, loaf tin, 30 cm) ¹		180–190	✓	1	2	30–40 ⁷
		190–200 ²	✓	1	2	30–40
Wholegrain bread (rack, loaf tin, 30 cm) ¹		190–200 ²	✓	1	2	55–65 ⁷
		200–210 ²	✓	1	2	45–55
Prove yeast dough (rack)		30–35	–	– ⁴	– ⁴	–







Function, Temperature, Booster, Shelf level (+HFC: with FlexiClip telescopic runners HFC 70-C / -HFC: without FlexiClip telescopic runners HFC 70-C), Cooking duration, Fan Plus, Conventional Heat, Moisture Plus, ✓ On, – Off

- 1 Use a dark coloured, matt baking tin and place it centrally on the rack.
- 2 Pre-heat the oven before placing the food inside.
- 3 Fit the FlexiClip telescopic runners HFC 70-C (if available) onto the bottom shelf level.
- 4 Place the rack on the floor of the oven, and stand the bowl with the dough on the rack. Depending on the size of the dish, you may need to remove the shelf runners.
- 5 Take the baking trays out of the oven early if the food has already browned sufficiently before the specified cooking time has elapsed.
- 6 Release 1 burst of steam at the beginning of the cooking programme.
- 7 Release 2 bursts of steam at the beginning of the cooking programme.

Cooking charts







Quark dough





Cakes/Biscuits (accessories)		Temperature [°C]		Shelf level ⁵ ₁		Cooking duration [min.]
				+HFC:	-HFC:	
Fresh fruit cake (1 tray)		160–170	✓	1	2	40–50
		170–180	✓	2	3	50–60
Apple turnovers/raisin scrolls (1 tray)		160–170	–	2	3	25–35
Apple turnovers/raisin scrolls (2 trays)		150–160	✓	1+3 ¹	1+3	25–35 ²

 Function,  Temperature,  Booster,  Shelf level (+HFC: with FlexiClip telescopic runners HFC 70-C / -HFC: without FlexiClip telescopic runners HFC 70-C),  Cooking duration,  Fan Plus,  Conventional Heat, ✓ On, – Off

- 1 Fit the FlexiClip telescopic runners HFC 70-C (if available) onto the bottom shelf level.
- 2 Take the baking trays out of the oven early if the food has already browned sufficiently before the specified cooking time has elapsed.













Sponge mixture









Cakes/Biscuits (accessories)		Temperature [°C]		Shelf level ⁵ ₁		Cooking duration [min.]
				+HFC:	-HFC:	
Sponge cake base (2 eggs) (rack, springform cake tin, Ø 26 cm) ¹		160–170 ²	–	1	2	15–25
Sponge cake base (4–6 eggs) (rack, springform cake tin, Ø 26 cm) ¹		150–160 ²	–	1	2	30–40
Whisked sponge (rack, springform cake tin, Ø 26 cm) ¹		180	–	1	2	25–35
		150–170 ²	–	1	2	25–45
Sponge cake base (tray)		180–190 ²	–	1	2	15–20

 Function,  Temperature,  Booster,  Shelf level (+HFC: with FlexiClip telescopic runners HFC 70-C / -HFC: without FlexiClip telescopic runners HFC 70-C),  Cooking duration,  Fan Plus,  Conventional Heat, ✓ On, – Off

- 1 Use a dark coloured, matt baking tin and place it centrally on the rack.
- 2 Pre-heat the oven before placing the food inside.

Choux pastry, puff pastry, meringue

Cakes/Biscuits (accessories)		 [°C]		 ⁵ +HFC: -HFC:		 [min.]
Choux buns (1 tray)		160–170	–	1	2	35–45 ²
Pastry puffs (1 tray)		180–190	–	1	2	20–30
Pastry puffs (2 trays)		180–190	–	1+3 ¹	1+3	20–30 ³
Macaroons (1 tray)		120–130	–	1	2	25–50
Macaroons (2 trays)		120–130	–	1+3 ¹	1+3	25–50 ³
Meringues/pavlovas (1 tray of 6, each Ø 6 cm)		80–100	–	1	2	120–150
Meringues/pavlovas (2 trays of 6, each Ø 6 cm)		80–100	–	1+3 ¹	1+3	150–180

 Function,  Temperature,  Booster, ⁵ Shelf level (+HFC: with FlexiClip telescopic runners HFC 70-C / -HFC: without FlexiClip telescopic runners HFC 70-C),  Cooking duration,  Moisture Plus,  Fan Plus,  On, – Off

- 1 Fit the FlexiClip telescopic runners HFC 70-C (if available) onto the bottom shelf level.
- 2 Release 1 burst of steam 8 minutes into the cooking programme.
- 3 Take the baking trays out of the oven early if the food has already browned sufficiently before the specified cooking time has elapsed.

Cooking charts



















Savoury snacks











Food (accessories)		Temperature [°C]				Cooking duration [min.]
				+HFC:	-HFC:	
Savoury flan (1 tray)		220–230 ¹	✓	–	1	35–45
		180–190	–	–	1	30–40
Onion tart (1 tray)		180–190 ¹	✓	1	2	25–35
		170–180	–	1	2	30–40
Pizza, yeast dough (1 tray)		170–180	✓	1	2	25–35
		210–220 ¹	–	1	2	20–30
Pizza, yeast dough (1 aluminium Pizza dish Ø 35 cm on rack)		200 ¹	–	–	1	13–16
Pizza, quark dough (1 tray)		170–180	✓	1	2	25–35
		190–200 ¹	✓	2	2	25–35
Frozen pizza, pre-cooked (rack)		200–210	–	1	2	20–25
Toast (rack)		250	–	–	3	5–8
Baked dishes/gratins (e.g. toast) (rack on universal tray)		250 ²	–	2	3	3–6
Grilled vegetables (rack on universal tray)		250 ²	–	3	4	5–10 ³
		250 ²	–	3	3	5–10 ³
Ratatouille (1 universal tray)		180–190	–	2	2	40–60

Function, Temperature, Booster, Shelf level (+HFC: with FlexiClip telescopic runners HFC 70-C / -HFC: without FlexiClip telescopic runners HFC 70-C), Cooking duration, Conventional Heat, Intensive Bake, Fan Plus, Eco Fan Heat, Full Grill, Fan Grill, ✓ On, – Off

- 1 Pre-heat the oven before placing the food inside.
- 2 Pre-heat the oven for 5 minutes before placing the food inside.
- 3 If possible, turn the food halfway through the cooking duration.

Beef















Food (accessories)		 [°C]		 5 1	 [min.]	 ¹⁰ [°C]
Braised beef, approx. 1 kg (oven dish with lid)	 ²	150–160 ³	✓	2 ⁶	120–130 ⁷	–
	 ²	170–180 ³	✓	2 ⁶	120–130 ⁷	–
	 ²	180–190	–	2 ⁶	160–180 ⁸	–
Fillet of beef, approx. 1 kg (universal tray)	 ²	180–190 ³	✓	2 ⁶	25–60	53–75
Fillet of beef, "rare", approx. 1 kg ¹	 ²	80–85 ⁴	–	2 ⁶	70–80	53–55
Fillet of beef, "medium", approx. 1 kg ¹	 ²	90–95 ⁴	–	2 ⁶	80–90	60–65
Fillet of beef, "well-done", approx. 1 kg ¹	 ²	95–100 ⁴	–	2 ⁶	110–130	70–75
Sirloin joint, approx. 1 kg (universal tray)	 ²	180–190 ³	✓	2 ⁶	35–65	53–75
Sirloin joint, "rare", approx. 1 kg ¹	 ²	80–85 ⁴	–	2 ⁶	80–90	53–55
Sirloin joint, "medium", approx. 1 kg ¹	 ²	90–95 ⁴	–	2 ⁶	110–120	60–65
Sirloin joint, "well-done", approx. 1 kg ¹	 ²	95–100 ⁴	–	2 ⁶	130–140	70–75
Burger, rissoles (rack on shelf level 4 and universal tray on shelf level 1)		250 ⁵	–	4	1: 11–17 2: 7–10 ⁹	–

 Function,  Temperature,  Booster,  Shelf level,  Cooking duration,  Core temperature,  Auto Roast,  Conventional Heat,  Eco Fan Heat,  Full Grill, ✓ On, – Off

- Use the rack and the universal tray.
- Sear the meat on the cooktop first.
- Pre-heat the oven before placing the food inside.
- Pre-heat the oven at 120 °C for 15 minutes. Reduce the temperature when you place the food in the oven.
- Pre-heat the oven for 5 minutes before placing the food inside.
- Fit the FlexiClip telescopic runners HFC (if available).
- Roast with the lid on first. Remove the lid after roasting for 90 minutes and add approx. 0.5 litre of liquid.
- Roast with the lid on first. Remove the lid after roasting for 100 minutes and add approx. 0.5 litre of liquid.
- Turn the food once it has browned sufficiently (1: Grill duration side 1, 2: Grill duration side 2).
- If you are using a food probe, you can use the core temperature shown.

Cooking charts

Veal

Food (accessories)		 [°C]		 5 1	 [min.]	 7 [°C]
Braised veal, approx. 1.5 kg (roasting dish with lid)	 2	160–170 ³	✓	2 ⁵	120–130 ⁶	–
	 2	170–180 ³	✓	2 ⁵	120–130 ⁶	–
Fillet of veal, approx. 1 kg (universal tray)	 2	160–170 ³	✓	2 ⁵	30–60	53–75
Fillet of veal, “rare”, approx. 1 kg ¹	 2	80–85 ⁴	–	2 ⁵	50–60	53–55
Fillet of veal, “medium”, approx. 1 kg ¹	 2	90–95 ⁴	–	2 ⁵	80–90	60–65
Fillet of veal, “well-done”, approx. 1 kg ¹	 2	95–100 ⁴	–	2 ⁵	90–100	70–75
Saddle of veal, “rare”, approx. 1 kg ¹	 2	80–85 ⁴	–	2 ⁵	80–90	53–55
Saddle of veal, “medium”, approx. 1 kg ¹	 2	90–95 ⁴	–	2 ⁵	100–130	60–65
Saddle of veal, “well-done”, approx. 1 kg ¹	 2	95–100 ⁴	–	2 ⁵	130–140	70–75

 Function,  Temperature,  Booster,  Shelf level,  Cooking duration,  Core temperature,  Auto Roast,  Conventional Heat, ✓ On, – Off

- 1 Use the rack and the universal tray.
- 2 Sear the meat on the cooktop first.
- 3 Pre-heat the oven before placing the food inside.
- 4 Pre-heat the oven at 120 °C for 15 minutes. Reduce the temperature when you place the food in the oven.
- 5 Fit the FlexiClip telescopic runners HFC (if available).
- 6 Roast with the lid on first. Remove the lid after roasting for 90 minutes and add approx. 0.5 litre of liquid.
- 7 If you are using a food probe, you can use the core temperature shown.

Pork













Food (accessories)		[°C]		5 1	[min.]	11 [°C]
Pork joint/pork neck roast, approx. 1 kg (oven dish with lid)		160–170	✓	2 ⁵	140–150 ⁶	80–90
		170–180	✓	2 ⁵	130–140 ⁶	80–90
Pork joint with crackling, approx. 2 kg (oven dish)		180–190	✓	2 ⁵	140–160 ^{7,8}	80–90
		190–200	✓	2 ⁵	130–150 ⁸	80–90
Fillet of pork, approx. 350 g ¹	2	90–100 ³	–	2 ⁵	70–90	60–75
Ham roast, approx. 1.5 kg (oven dish with lid)		160–170	–	2 ⁵	130–160 ⁹	80–90
Gammon joint, approx. 1 kg (universal tray)		160–170	✓	2 ⁵	55–65 ⁷	75–80
Gammon joint, approx. 1 kg ¹	2	95–105 ³	–	2 ⁵	140–160	75–80
Meat loaf, approx. 1 kg (universal tray)		170–180	✓	2 ⁵	60–70 ⁸	80–85
		190–200	✓	2 ⁵	70–80 ⁸	80–85
Bacon ¹		250 ⁴	–	4	3–5	–
Sausage ¹		220 ⁴	–	3 ⁵	8–15 ¹⁰	–







Function, Temperature, Booster, 5
1 Shelf level, Cooking duration, 11 Core temperature, Auto Roast, Conventional Heat, Moisture Plus, Eco Fan Heat, Full Grill, ✓ On, – Off

- 1 Use the rack and the universal tray.
- 2 Sear the meat on the cooktop first.
- 3 Pre-heat the oven at 120 °C for 15 minutes. Reduce the temperature when you place the food in the oven.
- 4 Pre-heat the oven for 5 minutes before placing the food inside.
- 5 Fit the FlexiClip telescopic runners HFC (if available).
- 6 Roast with the lid on first. Remove the lid after roasting for 60 minutes and add approx. 0.5 l of liquid.
- 7 After the heating-up phase, release a burst of steam 3 times manually throughout the cooking programme.
- 8 Add approx. 1 l of liquid halfway through roasting.
- 9 Roast with the lid on first. Remove the lid after roasting for 100 minutes and add approx. 0.5 l of liquid.
- 10 Turn the food halfway through cooking.
- 11 If you are using a food probe, you can use the core temperature shown.

Cooking charts











Lamb, game











Food (accessories)		 [°C]		 5 1	 [min.]	 6 [°C]
Leg of lamb on the bone, approx. 1.5 kg (oven dish with lid)		180–190	–	2 ⁴	100–120 ⁵	53–75
Saddle of lamb, off the bone (universal tray)	 1	180–190 ²	✓	2 ⁴	10–20	53–75
Saddle of lamb, off the bone (rack and universal tray)	 1	95–105 ³	–	2 ⁴	40–60	53–75
Saddle of venison, off the bone (universal tray)	 1	160–170 ²	–	2 ⁴	70–90	54–57
Roebuck saddle, off the bone (universal tray)	 1	140–150 ²	–	2 ⁴	25–35	60–81
Leg of wild boar, off the bone, approx. 1 kg (oven dish with lid)	 1	170–180	–	2 ⁴	100–120 ⁵	80–90

 Function,  Temperature,  Booster,  Shelf level,  Cooking duration,  Core temperature,  Conventional Heat, ✓ On, – Off

- 1 Sear the meat on the cooktop first.
- 2 Pre-heat the oven before placing the food inside.
- 3 Pre-heat the oven at 120 °C for 15 minutes. Reduce the temperature when you place the food in the oven.
- 4 Fit the FlexiClip telescopic runners HFC (if available).
- 5 Roast with the lid on first. Remove the lid after roasting for 50 minutes and add approx. 0.5 litre of liquid.
- 6 If you are using a food probe, you can use the core temperature shown.

Poultry, fish

Food (accessories)		Temperature [°C]			Cooking duration [min.]	Core temperature [°C]
Poultry, 0.8–1.5 kg (universal tray)		170–180	✓	2 ²	55–65	85–90
Chicken, approx. 1.2 kg (rack on universal tray)		180–190 ¹	–	2 ²	70–80 ³	85–90
Poultry, approx. 2 kg (oven dish)		180–190	✓	2 ²	100–115 ^{3,4}	85–90
Poultry, approx. 4 kg (oven dish)		160–170	✓	2 ²	180–200 ⁵	90–95
		180–190	✓	2 ²	180–200 ⁵	90–95
Fish, 200–300 g (e.g. trout) (universal tray)		170–180	✓	2 ²	25–35 ⁶	75–80
Fish, 1–1.5 kg (e.g. Australian salmon) (universal tray)		170–180	✓	2 ²	35–45 ⁶	75–80
Fish fillet in foil, 200–300 g (universal tray)		200–210	–	2 ²	25–30	75–80

 Function,  Temperature,  Booster,  Shelf level,  Cooking duration,  Core temperature,  Auto Roast,  Fan Grill,  Conventional Heat,  Moisture Plus,  Eco Fan Heat, ✓ On, – Off

- 1 Pre-heat the oven for 5 minutes before placing the food inside.
- 2 Fit the FlexiClip telescopic runners HFC (if available).
- 3 Turn the food halfway through grilling.
- 4 Add approx. 0.25 litre of liquid at the start.
- 5 Add approx. 0.5 litre of liquid after 30 minutes.
- 6 Manually inject 1 burst of steam 5 minutes into the cooking programme.
- 7 If you are using a food probe, you can use the core temperature shown.

Copyright and licences for the communication module

For the purpose of operating and controlling the communication module, Miele uses proprietary or third-party software that is not covered by open source licensing terms. These items of software/software components are protected by copyright. The copyright powers of Miele and third parties must be respected.

In addition, the communication module contains software components which are distributed under open source licensing terms. The open source components contained in the appliance along with the corresponding copyright notices, copies of the licensing terms valid at the time, and any further information can be accessed locally via IP using a web browser (*http://<IP address>/Licenses*), where <IP address> is the IP address of the appliance. The liability and warranty arrangements for the open source licences displayed in this location only apply in relation to the respective rights holders.

Miele Australia Pty. Ltd.

ACN 005 635 398

ABN 96 005 635 398

Level 4, 141 Camberwell Road
Hawthorn East, VIC 3123

1300 464 353 (1300 4 MIELE)

info@miele.com.au

www.miele.com.au

Miele New Zealand Limited

IRD 98 463 631

8 College Hill
Freemans Bay, Auckland 1011

0800 464 353 (0800 4 MIELE)

customercare@miele.co.nz

www.miele.co.nz

Miele Global Headquarters

Germany

Miele & Cie. KG

Carl-Miele-Straße 29

33332 Gütersloh

Federal Republic of Germany

DGC 7250

en-AU, NZ

M.-Nr. 12 182 690 / 06