

Miele

Operating Instructions



Canister Vacuum Cleaner

en-US

HS11

M.-Nr. 11 787 241

Only Miele FilterBags, filters and accessories with the "Original Miele" logo can be used with this vacuum. Only then can the suction power of the vacuum cleaner reach its optimum potential creating the best possible cleaning results.

USE OF NON-MIELE COMPONENTS MAY VOID THE WARRANTY.

 The use of FilterBags made of paper or a similar material, or FilterBags with a cardboard retaining plate can lead to serious damage to the vacuum cleaner and may void the warranty, just as with the use of FilterBags without the "Original Miele" logo.

The "Original Miele" Logo will appear on the packaging or directly on the FilterBag.



Purchasing new FilterBags and filters

Original Miele FilterBags and filters can be purchased from an authorized Miele vacuum dealer or by visiting the Miele store at www.mieleusa.com.

IMPORTANT SAFETY INSTRUCTIONS	4
Caring for the environment	9
Appliance description	10
Connection	12
Using the accessories supplied	15
Use	16
Parking, transport and storage	18
Maintenance	19
Purchasing new FilterBags and filters	19
Ordering the correct FilterBags and filters	19
FilterBag change indicator	20
How to replace the FilterBag.....	21
When to change the motor protection filter.....	22
How to change the motor protection filter	22
When to replace the exhaust filter	22
How to replace the AirClean exhaust filter	23
Replacing the AirClean Plus 50, Active AirClean 50, and HEPA AirClean 50 ex- haust filters	24
Replacing one type of exhaust filter with another	25
Cleaning and care	26
Frequently Asked Questions	27
Customer Service	28
Contact in case of fault	28
Warranty	28
Optional accessories	28
LIMITED WARRANTY - VACUUM CLEANERS USA	30

IMPORTANT SAFETY INSTRUCTIONS

READ ALL INSTRUCTIONS BEFORE USING THIS APPLIANCE

This vacuum cleaner complies with all current local and national safety requirements. Improper use can lead to personal injury and damage to property.

Please read the operating instructions before using the vacuum cleaner for the first time. They contain important information on the safety, use, and maintenance of the vacuum cleaner. This prevents both personal injury and damage to the appliance.

Miele expressly and strongly advises that you read and follow the instructions in the “Connection” chapter as well as the **IMPORTANT SAFETY INSTRUCTIONS**.

Miele cannot be held liable for injury or damage caused by non-compliance with these instructions.

Keep these operating instructions in a safe place and pass them on to any future user.

Always disconnect the vacuum cleaner from the power supply when you have finished using it, before changing any accessories, as well as for maintenance work, cleaning, and troubleshooting. Remove the plug from the electrical socket.

Correct use

- ▶ This vacuum cleaner is intended for cleaning flooring in domestic households and similar residential environments. This vacuum cleaner is not suitable for use on construction sites.
- ▶ This vacuum cleaner can be used for all normal cleaning of carpets, rugs and hard flooring.
- ▶ This vacuum cleaner is not intended for outdoor use.
- ▶ This vacuum cleaner is intended for use at altitudes of up to 13000 ft (4000 m) above sea level.

IMPORTANT SAFETY INSTRUCTIONS

- ▶ The vacuum cleaner must only be used to vacuum dry floor surfaces. Do not vacuum people or animals. Any other types of use, modifications, or alterations are not permitted.
- ▶ Persons which lack physical, sensory or mental abilities or experience with the machine should not use it without supervision or instruction by a responsible person.

Safety with children

- ▶ Danger of suffocation! Ensure that any plastic wrappings, bags, etc. are disposed of safely and kept out of the reach of children.
- ▶ Do not allow the vacuum cleaner to be used as a toy. Close attention is necessary when used near children.

WARNING

To reduce the risk of fire, electric shock or injury:

- ▶ Check the voltage rating of the vacuum cleaner before connecting the power cord to an electrical outlet. Your power source should correspond with the voltage rating plate located on the underside of the vacuum. Use only household AC outlets. Never use DC power sources. If you are not sure of your home's voltage supply, consult a qualified electrician. Connecting the vacuum cleaner to a higher voltage than indicated in these instructions may result in damage to the vacuum cleaner or injury.
- ▶ To reduce the risk of electric shock, this appliance has a polarized plug (one blade is wider than the other.) This plug will fit in a polarized outlet only one way. If the plug does not fit fully in the outlet, reverse the plug. If it still does not fit, contact a qualified electrician to install the proper outlet. Do not alter the plug in any way.

Technical safety

- ▶ Before using the vacuum cleaner and its accessories, check for any visible signs of damage. Do not use a damaged appliance.

IMPORTANT SAFETY INSTRUCTIONS

- ▶ Compare the connection data on the data plate of the vacuum cleaner (voltage and frequency) with that of the electricity supply. This data must match exactly. Without modifications, the vacuum cleaner is suited for 50 Hz or 60 Hz.
- ▶ The electrical outlet must be rated at 15 Amps.
- ▶ Reliable and safe operation of this vacuum cleaner can only be assured if it has been connected to the electricity supply.
- ▶ Repairs should only be performed by an authorized service agent in accordance with national and local safety regulations. Unauthorized repairs could cause injury or machine damage. Otherwise the warranty may be void.
- ▶ Do not pull or carry the vacuum cleaner by the power cord, and be careful not to damage the cord when withdrawing the plug from the socket. Keep the cord away from sharp edges and do not let it get pinched, for example, under a door. Avoid running the vacuum cleaner over the cord. This could damage the cord, plug or socket. The appliance must not be used if any of these have suffered damage.
- ▶ Do not use the vacuum cleaner if the power cord is damaged. If the power cord is damaged it must be replaced together with the cord reel. For safety reasons this must only be done by Miele Service or a Miele authorized service technician.
- ▶ Do not let the vacuum cleaner get wet. Clean only with a dry cloth or slightly damp cloth when disconnected from the electrical supply.
- ▶ Repairs should only be carried out by a Miele-authorized service technician. Repairs and other work by unqualified persons can cause considerable danger to users.
- ▶ Miele can only guarantee the safety of the appliance when genuine Miele replacement parts are used. Faulty components should only be replaced with genuine Miele parts.

IMPORTANT SAFETY INSTRUCTIONS

Proper use

- ▶ To avoid the risk of damage, do not use the vacuum cleaner without the FilterBag, dust compartment filter and exhaust filter in place.
- ▶ The dust compartment cover will not close without a FilterBag inserted. Do not force it.
- ▶ Do not vacuum up anything which has been burning or smoking, e.g., cigarettes, ashes or hot ash, whether glowing or apparently extinguished.
- ▶ Do not use the vacuum cleaner to vacuum up any water, liquid or damp dirt. Wait until any freshly cleaned or shampooed rugs or carpets are completely dry before attempting to vacuum.
- ▶ Do not use the vacuum cleaner to vacuum toner dust. Toner, such as that used in printers and photocopiers, can conduct electricity.
- ▶ Do not vacuum up any flammable or combustible liquids or gases and do not vacuum in areas where such substances are stored.
- ▶ Do not vacuum at head height and do not let the suction get anywhere near a person's head.

Accessories

- ▶ To avoid the risk of injury when vacuuming with a Miele turbo-brush, do not touch the rotating roller brush.
- ▶ It is not advisable to vacuum directly with the handle, i.e., without an accessory attached, as the rim could get damaged and you could hurt yourself on sharp edges.
- ▶ Only use FilterBags, filters, and accessories bearing the “ORIGINAL Miele” logo on the packaging. The manufacturer cannot otherwise guarantee the safety of the product.

IMPORTANT SAFETY INSTRUCTIONS

California Proposition 65

THE FOLLOWING WARNING IS REQUIRED BY THE STATE OF CALIFORNIA FOR CALIFORNIA RESIDENTS ONLY:



WARNING:

Cancer and Reproductive Harm - www.P65Warnings.ca.gov.

SAVE THESE INSTRUCTIONS

Disposing of sales packaging

The packaging material protects the vacuum cleaner from transport damage. The packaging materials used are selected from materials which are environmentally friendly for disposal and can therefore be recycled.

Recycling the packaging material reduces the use of raw materials in the manufacturing process and also reduces the amount of waste in landfill sites. Make sure the packaging is disposed of in the proper manner for your area.

Disposing of the FilterBags and filters

Filterbags and filters are made from environmentally friendly materials, and can be disposed of with the normal household waste, as long as they have been used exclusively for general household dust.

Disposing of your old appliance

Before disposing of your old appliance remove the FilterBag and filters and dispose of them with your household waste.

Electronic and electrical appliances contain many valuable materials. They also contain certain materials, compounds and components which were essential for their correct functioning and safety. These could be hazardous to your health and to the environment if disposed of with general waste or if handled incorrectly. Please do not, therefore, dispose of your old appliance with general waste.

Instead, please make use of officially designated collection and disposal points to dispose of and recycle electrical and electronic appliances. By law, you are solely responsible for deleting any personal data from the appliance prior to disposal. Please ensure that your old appliance poses no risk to children while being stored for disposal.

Appliance description



The illustration shows the maximum number of features available

- ① Handle
- ② Air inlet valve
- ③ Release buttons *
- ④ Telescopic suction wand *
- ⑤ Telescopic suction wand release button *
- ⑥ Connection socket
- ⑦ Release buttons for the dust compartment cover
- ⑧ Motor protection filter
- ⑨ Original Miele filter bag
- ⑩ Floorhead *
- ⑪ Carrying handle
- ⑫ Park system for storage (on both sides of the vacuum cleaner)
- ⑬ Original Miele exhaust filter *
- ⑭ Foot switch for automatic cord rewind
- ⑮ Power cord
- ⑯ Rotary selector
- ⑰ Park system for pauses during vacuuming
- ⑱ On/off ① foot switch
- ⑲ Release button for accessories compartment
- ⑳ Filter bag change indicator

* These features are model-specific and may vary or may not be available on your vacuum cleaner.

Connection

Attaching the suction hose

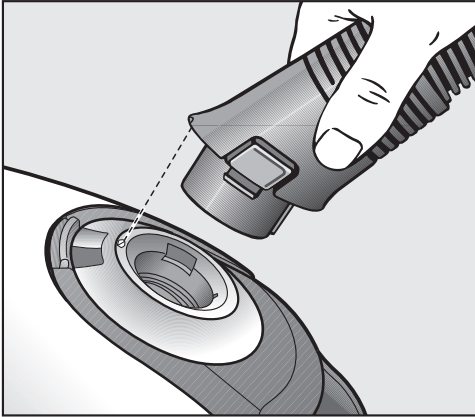

- Insert the hose connector into the suction socket on the vacuum cleaner until it clicks into position. To do this, line up the guides on the two pieces.

Disconnecting the suction hose

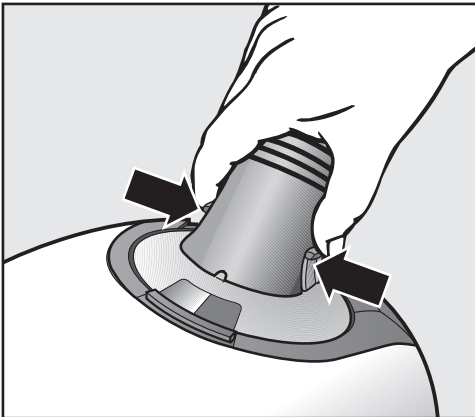

- Press the release buttons at the side of the hose connector, and lift the hose from the socket.

Connect the suction hose to the handle

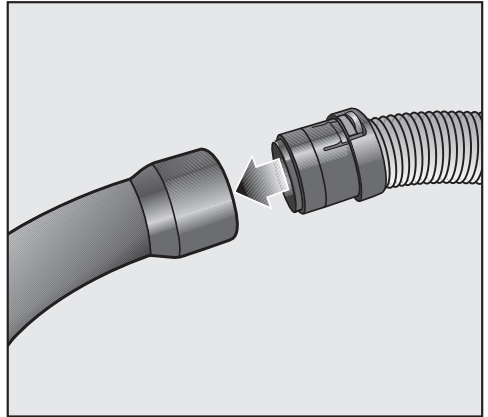

- Fit the connector at the other end of the suction hose into the handle until it clicks into position.

Connecting the handle to the suction wand

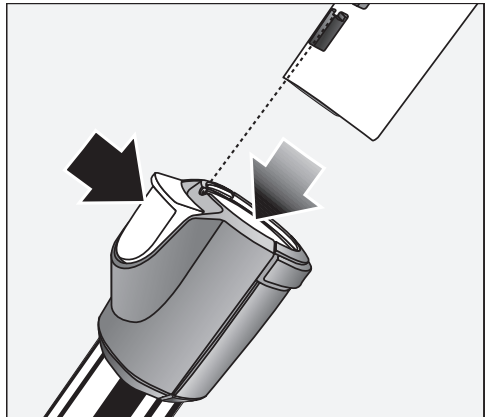

- Insert the handle into the suction wand until it clicks into position. To do this, line up the guides on the two pieces.

- To release the handle from the suction wand, press the release button and pull the handle out of the wand, twisting it slightly as you do so.

Adjusting the telescopic suction wand

One part of the telescopic suction wand is packed inside the other, and it can be adjusted to suit your height for comfortable vacuuming.

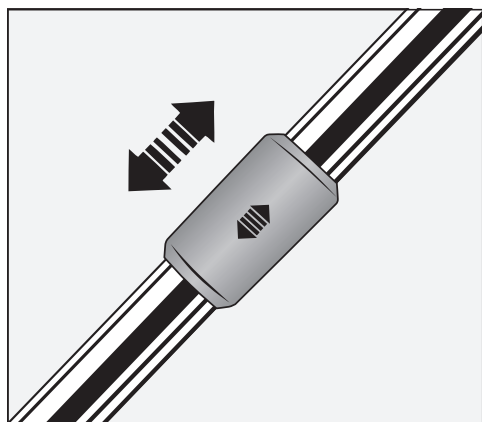

- Grasp the release mechanism and adjust the telescopic suction wand to the required length.

Connect the suction wand to the floorhead

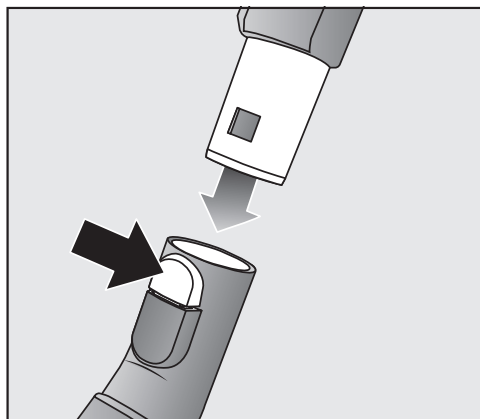

- Push the suction wand into the floorhead and turn it clockwise or counterclockwise until it clicks into position.
- To separate the suction wand from the floorhead, press the release button and pull the suction wand away from the floorhead, twisting it slightly as you do so.

Adjusting the floorhead

(only for models with a reversible floorhead included in the standard version)

This vacuum cleaner can be used for the everyday cleaning of carpets, rugs and hard flooring.

Miele offers a range of other floorheads, brushes and accessories for other types of flooring and special applications (see “Optional accessories”).

Please always follow the flooring manufacturer's cleaning and care instructions.

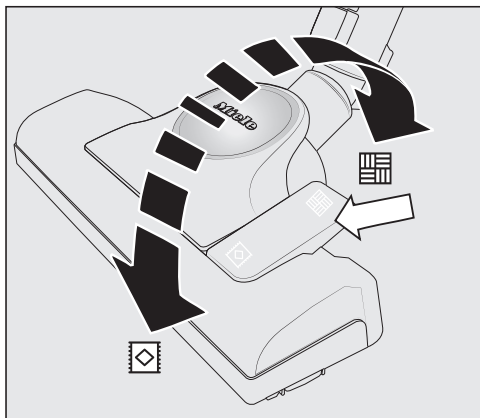

Vacuum carpets and rugs with the brush retracted:

- Press the foot switch .

Clean hard flooring which is not susceptible to scratching, and flooring with gaps or deep crevices in it with the brush protruding:

- Press the foot switch .

If the suction power of the adjustable floorhead seems too high, reduce the suction until the floorhead is easier to maneuver (see “Use” – “Regulating the suction power”).

Activating the TimeStrip® exhaust filter change indicator on the exhaust filter

Depending on the model, your vacuum cleaner will be fitted as standard with one of the following exhaust filters.

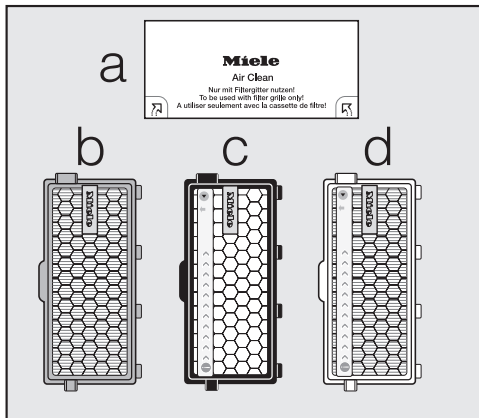

- a AirClean
- b AirClean Plus 50 (light blue)
- c Active AirClean 50 (black)
- d HEPA AirClean 50 (white)

If your vacuum cleaner is fitted with exhaust filter **c** or **d**, you need to activate the TimeStrip® exhaust filter change indicator.

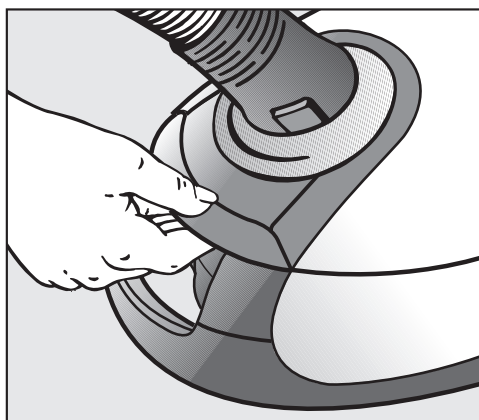

- Press the release button on the recessed grip and raise the dust compartment lid as far as it will go.

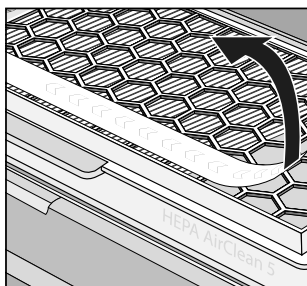

- Remove the indicator strip.

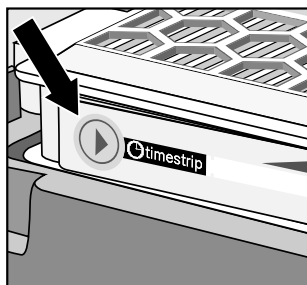

- Press the TimeStrip® exhaust filter change indicator.



After approx. 10–15 seconds a thin red line will appear in the left-hand side of the display.

- Close the dust compartment lid securely, making sure it clicks into position. Take care not to trap the filter bag when doing so.

How the TimeStrip® exhaust filter change indicator works

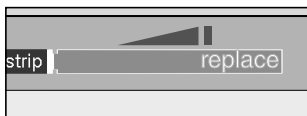

The TimeStrip® exhaust filter change indicator shows the remaining functional life of the exhaust filter. After approx. 50 operating hours the display will be completely filled with red. 50 operating hours equates to approximately one year of use.

Using the accessories supplied



- ① Crevice nozzle
- ② Dusting brush
- ③ Upholstery nozzle

Opening the accessories compartment

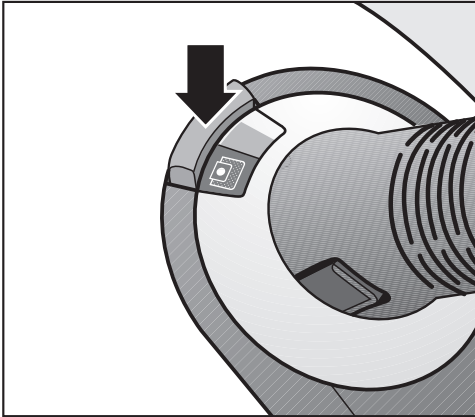

- Press the release button on the accessories compartment lid.

The accessories compartment will then open.

- Take out the accessory you require.
- Press down firmly on the lid to close it.

Reversible floorhead

(included as standard depending on model)

For general use and also for vacuuming the stairs.

 For safety reasons when vacuuming stairs, it is best to start at the bottom of the stairs and move upwards.

Use

Unwinding the power cord

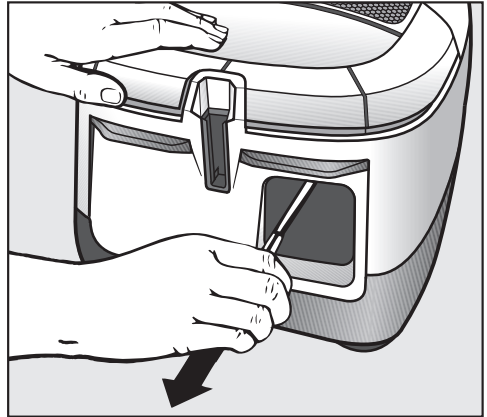

- Pull the power cord out to the required length.
- Insert the plug into the electrical socket.

 Risk of damage due to overheating.

The power cord may overheat after a long period of use.

If vacuuming for longer than 30 minutes, the power cord must be pulled out all the way.

Rewinding the power cord

- Remove the plug from the electrical socket.

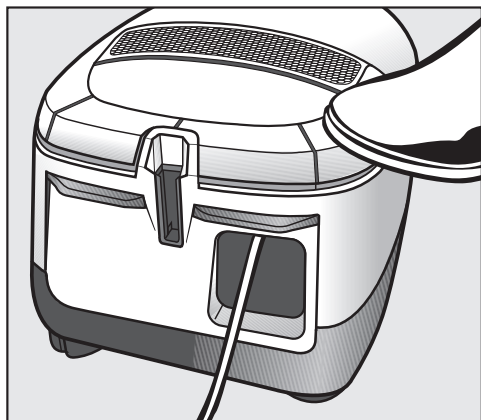

- Press the rewind foot switch. The power cord will rewind automatically.

Switching on and off

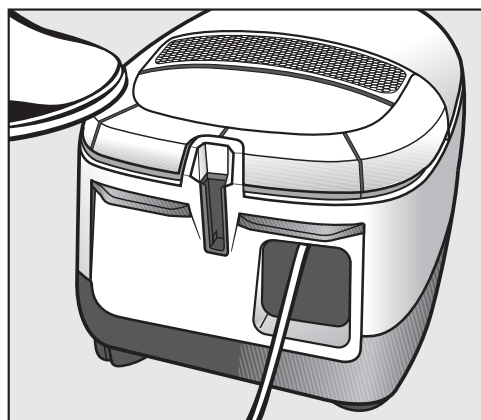







- Press the On/Off foot switch ①.

Regulating the suction power

The suction power can be regulated to suit the type of flooring being cleaned. Reducing the suction power reduces the amount of effort required to maneuver the floorhead.

The vacuum cleaner has symbols on the controls which indicate the type of use the settings are suitable for.

-  Curtains, fabrics
-  Upholstery, cushions
-  Deep-pile carpets, rugs, and runners
-  Energy-saving normal vacuuming with low noise
-  Low-pile carpet and rugs
-  Hard flooring and heavily soiled carpets and rugs

When using the adjustable floorhead, if the suction seems too high, reduce the suction until the floorhead is easier to maneuver.

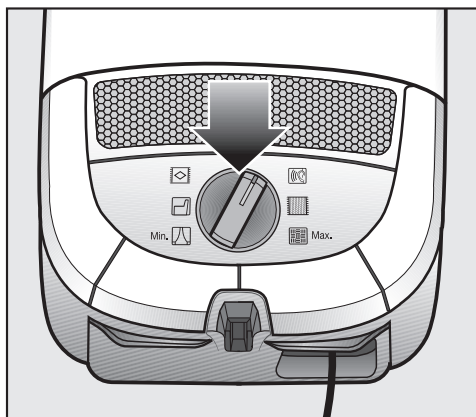

- Turn the suction power selector manually to the suction power setting you require.

Opening the air inlet valve

It is easy to reduce the suction power for a short time, e.g., to prevent rugs or other objects being sucked into the vacuum cleaner.

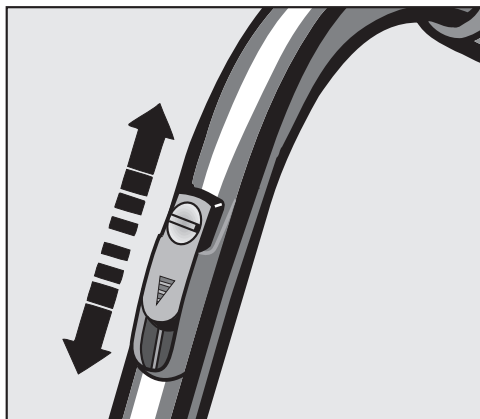

- Open the air inlet valve on the handle far enough to reduce the suction power.

The floorhead will be easier to maneuver.

During vacuuming

- When vacuuming, pull the vacuum cleaner behind you on its wheels. You can stand it upright for vacuuming stairs and curtains, etc.

Parking, transport and storage

Park system for pauses during vacuuming

The park system allows you to conveniently park the suction wand and floorhead during pauses.

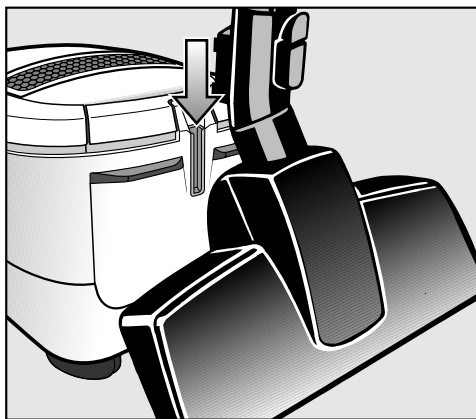

- Slot the floorhead into the parking attachment on the vacuum cleaner.

If your vacuum cleaner is on a sloping surface, e.g., a ramp, retract the telescopic suction wand fully.

Park system for storage

 Always disconnect the vacuum cleaner from the power supply when you have finished using it. Remove the plug from the socket.

- Stand the vacuum cleaner upright.

It is a good idea to retract the telescopic suction wand fully.

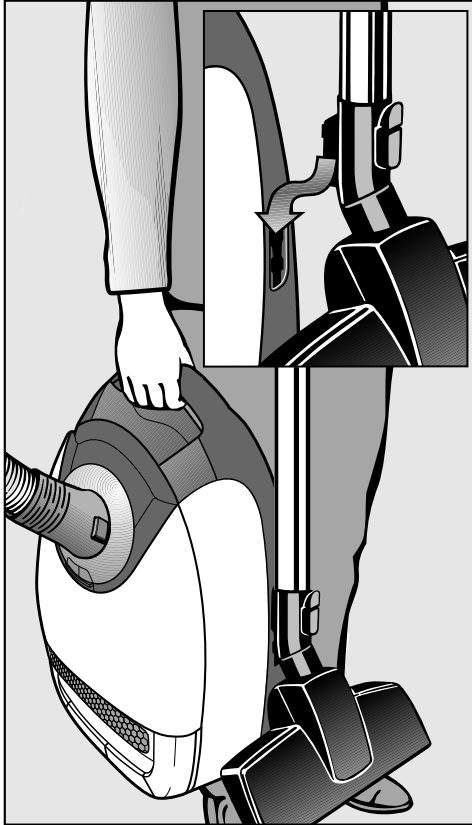

- Slot the floorbrush downwards into one of the parking attachments on the sides of the vacuum cleaner.

This makes the vacuum cleaner easier to carry or store.

Maintenance

⚠ Always switch off the vacuum cleaner for maintenance work and remove the plug from the outlet.

The Miele filtration system consists of three components:

- Original Miele FilterBag

- Motor protection filter
- Original Miele exhaust filter

These will need to be replaced from time to time to ensure that your vacuum cleaner performs efficiently.

It is recommended to use only genuine Miele accessories bearing the “ORIGINAL Miele” logo on the packaging. Only these will guarantee the optimum performance of your vacuum cleaner and the best possible cleaning results.

FilterBags with the “ORIGINAL Miele” logo on the packaging are not made from paper or paper-based materials and nor do they have a cardboard collar. This is why Miele FilterBags are particularly long-lasting and reliable.

Please note that faults and damage caused by use of accessories which do not bear the “ORIGINAL Miele” logo on the packaging are not covered by the vacuum cleaner warranty.

Purchasing new FilterBags and filters

Original Miele FilterBags and filters are available from the Miele Webstore and your Miele dealer.

Ordering the correct FilterBags and filters

Only use original Miele **GN** FilterBags with a **blue collar** and original Miele filters. These are identified by the “ORIGINAL Miele” logo on the packaging.



Every packet of original Miele FilterBags contains four bags, one AirClean exhaust filter, and one motor protection filter. Original Miele multipacks contain 16 FilterBags, four AirClean exhaust filters, and four motor protection filters.

Original Miele exhaust filters can also be purchased separately from your Miele dealer or Miele Service. Please quote the model number of your vacuum cleaner when ordering to make sure you get the correct filter. You can also order all accessories via the Miele Webstore.

FilterBag change indicator

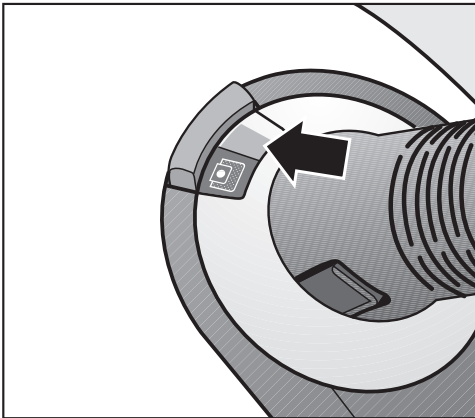

Change the FilterBag when the color marker in the FilterBag change indicator turns red.

Blocked pores reduce the efficiency of the vacuum cleaner.
Dispose of the FilterBag when it is full.
Do not attempt to re-use the FilterBag.

Checking the FilterBag change indicator

- Attach the adjustable floorhead or the floorbrush to the vacuum cleaner (included as standard depending on model).
- Switch the vacuum cleaner on and select the highest power setting.
- Lift the adjustable floorhead/floorbrush off the floor a little.

How the FilterBag change indicator works

The FilterBag change indicator is designed for normal household dust. This generally contains a mixture of dust, hair, threads, carpet fluff, grit, etc.

However, if the vacuum cleaner has been used to vacuum up fine dust, such as drilling dust, sand, plaster dust, or flour, the pores of the FilterBag will become blocked very quickly.

The indicator will indicate that the bag is “full” even when it is not. The FilterBag must be replaced if this is the case.

If, on the other hand, you vacuum up a significant amount of hair, carpet lint, etc., the FilterBag will be full to bursting before the indicator reacts.

How to replace the FilterBag

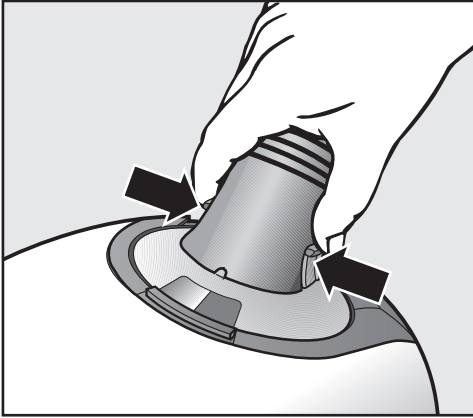

- Press the release catches at the side of the hose connector, and remove the hose from the socket.

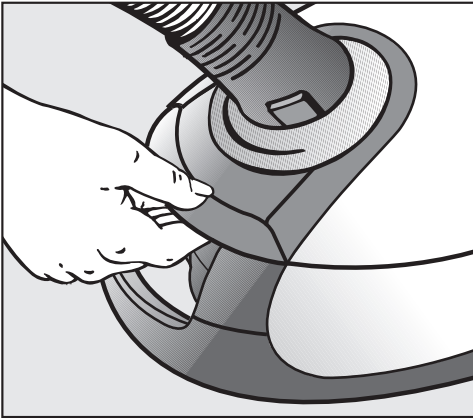

- Lift the release catch for the dust compartment lid and raise the lid as far as it will go.

The FilterBag has a flap which closes automatically when the dust compartment lid is raised to prevent any dust escaping.

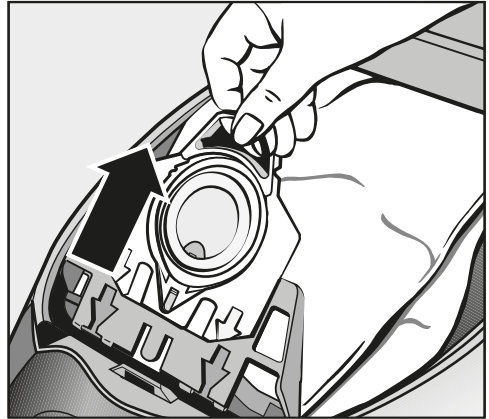

- Pull the FilterBag out by the grip on the collar.

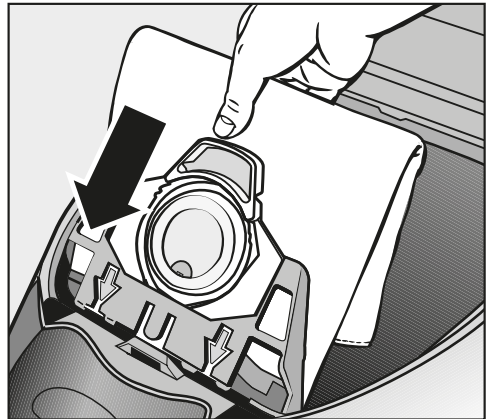

- Fit the new FilterBag into the holder as far as it will go. Leave it folded up when you take it out of the box.
- Close the dust compartment lid securely, making sure it clicks into position. Take care not to trap the FilterBag when doing so.

An empty operation lock prevents the dust compartment lid from closing without a FilterBag in place. Do not use force!

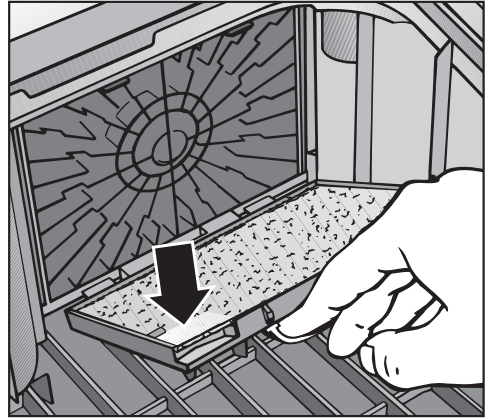
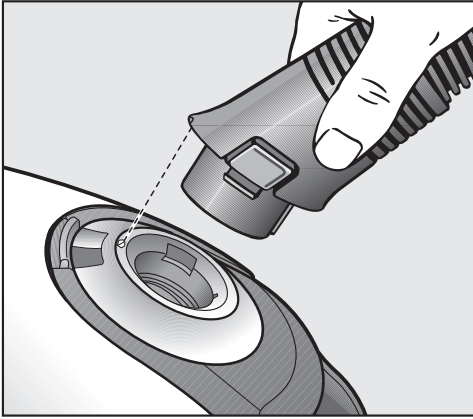

- Insert the hose connector into the suction socket on the vacuum cleaner until it clicks into position. To do this, line up the guides on the two pieces.

When to change the motor protection filter

Replace this filter every time you start a new packet of filter bags. Every packet of original Miele filter bags contains a motor protection filter. Multipacks contain four motor protection filters.

How to change the motor protection filter

- Open the dust compartment lid.
- Pull the filter bag out by the grip on the collar.

- Lift up the filter frame until it clicks and remove the old motor protection filter. Hold by the clean, unsoiled section to remove it.
- Replace with a new motor protection filter.
- Close the filter frame.
- Fit the filter bag into the holder as far as it will go.
- Close the dust compartment lid securely, making sure it clicks into position. Take care not to trap the filter bag when doing so.

When to replace the exhaust filter

Depending on the model, your vacuum cleaner will be fitted as standard with one of the following exhaust filters.

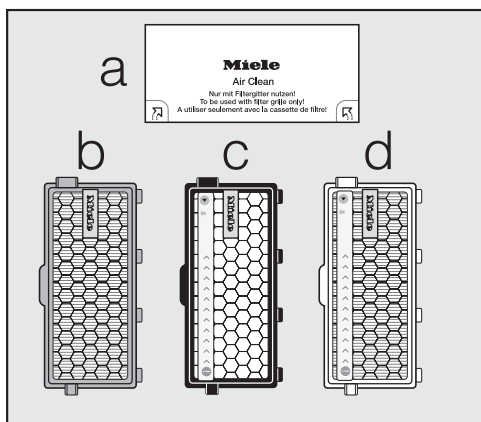

a AirClean

Replace this filter every time you start a new packet of filter bags. Every packet of original Miele filter bags contains one AirClean exhaust filter. Multipacks contain four AirClean filters.

b AirClean Plus 50 (light blue)

Replace this filter after approx. one year. Make a note of the date on the exhaust filter.

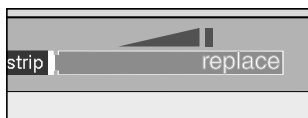

c Active AirClean 50 (black)

d HEPA AirClean 50 (white)

Replace this filter when the TimeStrip® exhaust filter change indicator is completely red. The indicator lights up after approximately 50 operating hours, which is equivalent to about a year of average use. You can continue vacuuming when the light comes on. However, the suction power will be reduced as will the effectiveness of the filter.

How to replace the AirClean exhaust filter

Do not use more than one exhaust filter at a time.

- Open the dust compartment lid.

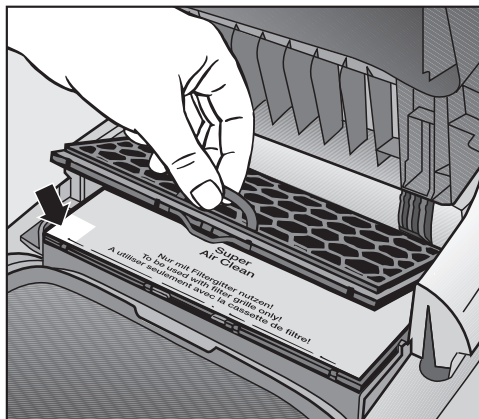

- Release the filter grille and raise it upwards as far as it will go.
- Grasp the used AirClean exhaust filter by the clean, unsoiled section and take it out (see arrow).

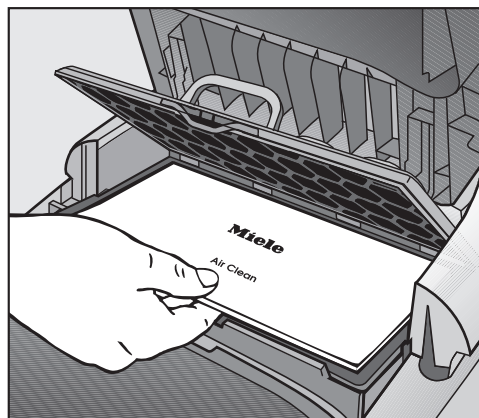

- Replace it with a new AirClean exhaust filter.

If you wish to fit the AirClean Plus 50, Active AirClean 50, or HEPA AirClean 50 exhaust filter, see “Replacing one type of exhaust filter with another”.

- Close the filter grille.
- Close the dust compartment lid.

Replacing the AirClean Plus 50, Active AirClean 50, and HEPA AirClean 50 exhaust filters

Do not use more than one exhaust filter at a time.

- Open the dust compartment lid.

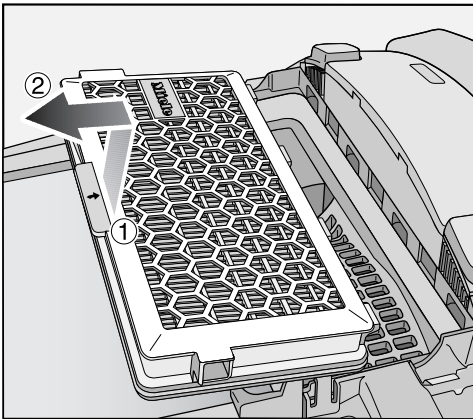

- Lift the exhaust filter and remove it.

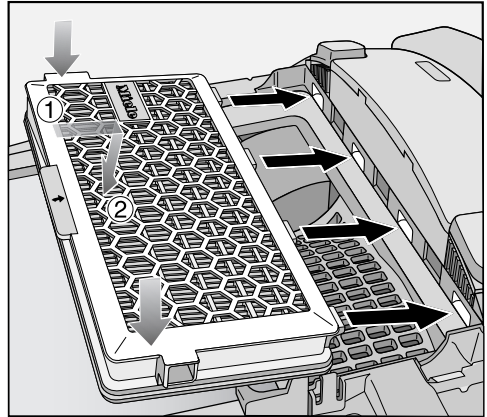

- Insert a new exhaust filter, making sure it goes in properly, then push it down into position.



- If you are using exhaust filter **c** or **d**, press the TimeStrip® exhaust filter change indicator.

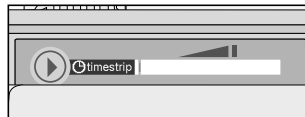

After approx. 10–15 seconds, a thin red line will appear in the left hand side of the display for both exhaust filters.

If you wish to fit the AirClean exhaust filter, see “Replacing one type of exhaust filter with another”.

- Close the dust compartment lid.

Replacing one type of exhaust filter with another

Depending on model, your vacuum cleaner will be fitted as standard with one of the following exhaust filters:

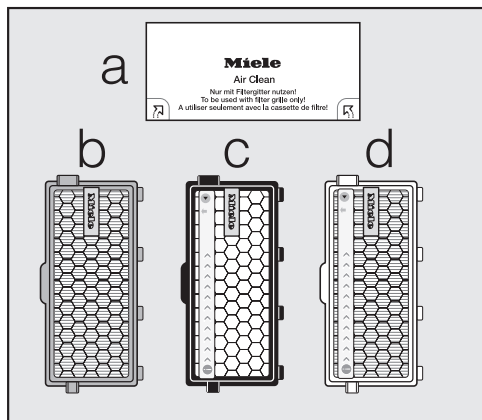

- a AirClean
- b AirClean Plus 50 (light blue)
- c Active AirClean 50 (black)
- d HEPA AirClean 50 (white)

Do not use more than one exhaust filter at a time.

When changing the filter please note

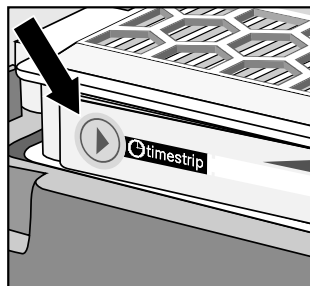

1. If you wish to replace exhaust filter **a** with filter **b**, **c**, or **d**, it is essential that you remove the filter grille before you fit the new exhaust filter.

If you are using exhaust filter **c** or **d**, you must also activate the TimeStrip® exhaust filter change indicator.

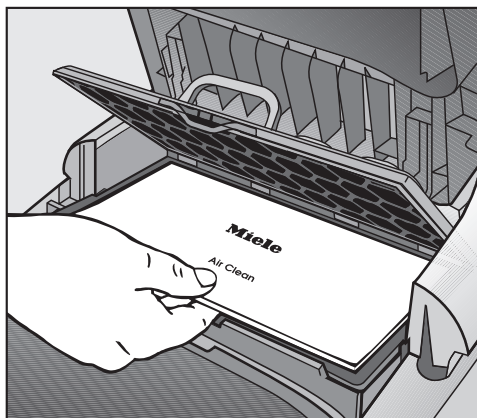

2. If you wish to replace exhaust filter **b**, **c**, or **d** with filter **a**, it is essential that you also fit the filter grille*.

* Filter grille – see “Optional accessories”

Replacement parts are available from your Miele dealer or through Miele Service.

Cleaning and care

 Risk of electric shock from voltage.

The supply voltage is applied to the appliance even if it is switched off. Before cleaning, unplug the appliance from the electrical socket.

Vacuum cleaner and accessories

 Risk of electric shock from voltage.

If moisture gets into the vacuum cleaner, there is a risk of electric shock.

Do not let the vacuum cleaner get wet.

The vacuum cleaner and all plastic accessories can be cleaned with a commercially available cleaner suitable for plastic.

 Damage due to unsuitable cleaning agents.

All surfaces are susceptible to scratching. Contact with unsuitable cleaning agents can alter or discolor the external surfaces.

Do not use abrasive cleaning agents, glass cleaning agents, all-purpose cleaners, or oil-based conditioning agents.

Dust compartment

The dust compartment can, if necessary, be cleaned using a dry duster, brush or, if available, a second vacuum cleaner to vacuum the dust out.

Frequently Asked Questions

With the help of the following guide minor faults in the performance of the machine, some of which may result from incorrect operation, can be remedied without contacting the Service Department.

This guide may help you to find the reason for the fault, and how to correct it.

Problem	Possible cause and solution
The vacuum cleaner turns off automatically.	<p>A temperature limiter switches the vacuum cleaner off automatically if it gets too hot. This can occur if, for instance, large objects block the suction wand or when the FilterBag is full or contains particles of fine dust. A heavily soiled motor protection filter or exhaust filter can also be the cause of overheating.</p> <ul style="list-style-type: none">■ Switch the vacuum cleaner off immediately using the On/Off foot switch ①. Unplug from the electrical socket. <p>After removing the cause of the fault, wait for approximately 20–30 minutes to allow the vacuum cleaner to cool down. It can then be turned on again.</p>

Customer Service

Contact in case of fault

In the event of a fault which you cannot remedy yourself, please contact your Miele dealer or Miele Service.

Contact information for Miele Service can be found at the end of this document.

Warranty

For more information about warranty conditions, please contact Miele Service.

Optional accessories

Please observe the flooring manufacturer's cleaning and care instructions.

These and many other products can be ordered from the Miele web store, Miele Customer Service, or from your Miele dealer.

Certain models are supplied as standard with one or more of the following accessories.

Floor tools / Brushes

TurboTeQ Turbobrush (STB 305-3)

This brush is ideal for cleaning short-pile carpet.

Floor brush Parquet (SBB Parquet-3)

This brush has natural bristles and is designed for use on smooth floors that are susceptible to scratching.

Parquet Twister floorbrush with swiveling head (SBB 300-3)

With natural bristle for vacuuming smooth hard floors and small gaps.

Floorbrush Parquet Twister XL with swiveling head (SBB 400-3)

With natural bristles for quickly vacuuming smooth hard floors and small gaps.

Other accessories

Turbobrush Turbo Mini (STB 101)

For vacuuming upholstery, mattresses or car seats, etc.

Universal brush (SUB 20)

For dusting books, shelves, etc.

Radiator brush (SHB 30)

For dusting radiators, narrow shelves and crevices.

Mattress tool (SMD 10)

For vacuuming upholstery, mattresses, cushions, curtains, covers, etc.

Crevice nozzle, 12" (300 mm) (SFD 10)

Extra long crevice nozzle for cleaning in folds, crevices and corners.

Crevice nozzle, 22" (560 mm) (SFD 20)

Flexible crevice nozzle for vacuuming hard to reach places.

XL upholstery nozzle (SPD 20)

Wide upholstery nozzle for cleaning upholstery, mattresses, and cushions.

Filters

AirClean Plus 50 exhaust filter (SF-AP 50)

Effective filtration for particularly clean room air.

Active AirClean 50 exhaust filter (SF-AA 50)

For a significant reduction of unpleasant odors. Ideal for households with pets or smokers.

HEPA AirClean 50 exhaust filter (SF-HA 50)

Effectively filters fine dust and allergens. Ideal for people allergic to house dust.

Filter grille

The filter grille is required if you wish to use an AirClean exhaust filter instead of an AirClean Plus 50 exhaust filter, an Active AirClean 50 exhaust filter or a HEPA AirClean 50 exhaust filter.

LIMITED WARRANTY - VACUUM CLEANERS USA

What This Warranty Covers and For What Period The Coverage Extends

Miele, Inc. (hereinafter "Miele") warrants to the original purchaser of this product, living in the United States of America, who purchased their vacuum from a Miele Authorized Dealer:

- a. That this product, including all of its Miele authorized parts is free of defects in material and workmanship.
- b. That this product, if found to be defective within the stated warranty period, will be repaired free of charge to the consumer (both parts and labor) by an authorized Miele service agent.
- c. The warranty period for vacuum cleaners, with the exception of "HomeCare" sub-models, is as follows:

Vacuum Series	Term
Classic Series Canister Vacuums	1 year
Swing Series H1 Vacuums	1 year
Compact Series Canister Vacuums	2 years
Scout Robotic Vacuums	2 years
Triflex HX1 Series Cordless Vacuums	2 years
Complete Series Canister Vacuums	3 years
Dynamic Series Upright Vacuums	3 years
Blizzard Bagless Series Canister Vacuums	3 years

- d. The warranty period for all "HomeCare" sub-model types is 5 (five) full years from the date of purchase, while the Triflex HX1 HomeCare is 3 (three) full years from the date of purchase.
- e. This warranty only applies while the product remains within the United States, and is null and void in any other US territories, possessions, or foreign countries.

Commercial Use

Vacuum cleaners other than the Scout RX1 and Scout RX2 used for commercial purposes will be warranted for a period of six (6) months from the date of purchase. There is no warranty for the Scout RX1 or Scout RX2 used for commercial purposes. Thereafter this Limited Warranty shall be null and void.

What is not covered by this Warranty

This warranty does not cover damage or defects caused by or resulting from repairs, service or alterations to the product or any of its parts or accessories which have been performed by service centers or repairmen not authorized by Miele, or damage or defects caused by negligence, accident, abuse, misuse, improper or abnormal usage or maintenance of the product, its parts or accessories, or damages caused by the use or installation of non-genuine Miele parts. Ordinary wear and tear or cosmetic damage (scuffs, scratches, gouges, dents, etc.) shall not be considered a defect in materials or workmanship.

Exclusion of Other Warranties

Except for the limited warranty provided herein, Miele disclaims any and all other express warranties with respect to the product. Any warranty of merchantability or fitness for a particular purpose is limited in its duration to the term of the limited warranty provided herein.

Some states do not allow limitations on how long an implied warranty lasts, so the above limitation may not apply to you.

Some states do not allow limitations on how long an implied warranty lasts, so the above limitation may not apply to you.

Limitation of Liability for Special, Incidental or Consequential Damages

Miele will assume no liability, or other obligation with respect to any personal injury or property damage resulting from the use of a vacuum cleaner, or its accessories, replacement parts, etc., which has not been purchased from, or serviced by an Authorized Miele Dealer. Any purchaser who obtains a vacuum cleaner, accessories, replacement parts, etc., from someone other than an Authorized Miele dealer proceeds at their own risk.

Miele specifically disclaims any and all liability, whether directly or by way of indemnity, for special incidental, consequential or other damages, whether based on breach of contract, tort, strict or product liability, or any other legal theory.

Some states do not allow the exclusion or limitation of incidental or consequential damages, so the above limitation may not apply to you.

Special State Laws

This Limited Warranty gives you specific legal rights; you may have other rights, which vary, from state to state.

Service

For service under this Limited Warranty, or to find an Authorized Miele Dealer in your area, please visit the "Find a Miele Partner Near You" section at Mieleusa.com.

Effective Date: July 20, 2020

©2020 Miele, Inc.

Miele

**Please have the model and serial number
of your appliance available when
contacting Customer Service.**

U.S.A.

Miele, Inc.

National Headquarters

9 Independence Way
Princeton, NJ 08540
Phone: 800-843-7231
Fax: 609-419-4298
www.mieleusa.com

Customer Service & Support

Phone: 888-99-MIELE(64353)
Fax: 888-586-8056
service@mieleusa.com

International Headquarters

Miele & Cie. KG
Carl-Miele-Straße 29
33332 Gütersloh
Germany

Canada

**Importer
Miele Limited**

Headquarters and Miele Centre

161 Four Valley Drive
Vaughan, ON L4K 4V8
www.miele.ca

Customer Care Centre

Phone: 800-565-6435
905-532-2272
customercare@miele.ca