

## Operating instructions 30 Inch Induction Range (Electric oven and Induction cooktop)



To prevent accidents and damage to the range, you **must** read all instructions supplied before installing or using the appliance.

# IMPORTANT SAFETY INSTRUCTIONS

## WARNING

Children and adults can tip over the range if has not been secured. This may lead to fatal injuries.



- ▶ This range must be secured and connected using the anti-tip device according to the installation instructions.
- ▶ If you have moved the range, slide the locking latch onto the anti-tip device until you feel it lock into place.
- ▶ Do not use the range if the anti-tip device has not been properly installed and engaged.
- ▶ Failure to observe the information contained in the installation instructions can lead to serious or fatal injuries for children and adults.

	 <b>WARNING</b>
	<p>All ranges can tip</p> <p>Injury to persons could result</p> <p>Install anti-tip devices packed with range</p> <p>See installation instructions</p>

<b>IMPORTANT SAFETY INSTRUCTIONS</b> .....	<b>2</b>
<b>IMPORTANT SAFETY INSTRUCTIONS</b> .....	<b>6</b>
<b>Guide to the range</b> .....	<b>18</b>
Induction cooktop .....	18
Oven .....	19
<b>Controls for the range</b> .....	<b>20</b>
Control elements for the induction cooktop .....	20
Cooking zone knobs and display with cooking zone indicators .....	21
Cooking zone knob symbols .....	21
Symbols on the cooktop display .....	21
Oven controls.....	22
<b>Features</b> .....	<b>25</b>
Data plate .....	25
Scope of delivery .....	25
Standard and optional accessories .....	25
Safety features of the induction cooktop.....	28
Using the system lock.....	28
Safety shut-off.....	28
Residual heat indicator .....	28
Pan/pan size recognition .....	28
Using demo mode .....	29
Overheating protection .....	29
Oven safety features .....	29
PerfectClean treated surfaces.....	30
Self-Clean-ready accessories.....	30
<b>Initial commissioning</b> .....	<b>31</b>
Before using for the first time .....	31
Cleaning the cooktop before heating it up for the first time .....	32
Installing the side racks and heating up the oven for the first time .....	32
<b>Operating the induction cooktop</b> .....	<b>34</b>
How induction works .....	34
Cookware .....	34
Noises .....	35
Energy-saving tips .....	35
Cooking zone data.....	36
Turning on the induction cooktop .....	37
Auto heat-up .....	37
Activating Auto heat-up .....	37
Deactivating Auto heat-up .....	37
Using the power levels .....	38

# Contents

---

Booster .....	39
Activating the Booster .....	39
Activating TwinBooster at level 1.....	39
Activating TwinBooster at level 2.....	39
Deactivating Booster/TwinBooster.....	39
Keeping warm .....	39
Setting the Keeping warm setting.....	39
Turning the induction cooktop off .....	40
Residual heat indicator .....	40
<b>Using the oven .....</b>	<b>41</b>
Overview of operating modes .....	41
Energy-saving tips .....	41
Simple operation .....	42
Preheating the oven .....	42
Operating the clock/timer.....	43
Switching cooking programs on and off automatically .....	43
Changing the time of day.....	45
Changing factory default settings .....	45
Switching the system lock  on and off .....	49
Using the timer  .....	49
<b>Baking.....</b>	<b>51</b>
Tips for baking.....	51
Notes on the operating modes.....	52
<b>Roasting .....</b>	<b>53</b>
Tips for roasting .....	53
Notes on the operating modes.....	54
<b>Broiling .....</b>	<b>55</b>
Tips for broiling .....	55
Notes on the operating modes.....	56
<b>Additional applications .....</b>	<b>57</b>
Defrost .....	57
Dehydrating.....	58
Warm-up Cookware.....	58
Slow Roasting.....	59
Canning.....	61
Frozen food/ready meals.....	63
<b>Cleaning and care of the induction cooktop .....</b>	<b>64</b>

<b>Cleaning and care of the oven</b> .....	<b>66</b>
Unsuitable cleaning agents.....	66
Removing normal soiling.....	67
Removing stubborn soiling.....	67
Cleaning the oven compartment with Self clean  (Clean).....	68
Starting Self Clean.....	68
At the end of the Self Clean program.....	70
Self Clean interrupted.....	71
Removing the door.....	72
Installing the door.....	73
Side rack removal.....	74
<b>Frequently asked questions</b> .....	<b>75</b>
<b>Customer Service</b> .....	<b>81</b>
Contact in the event of a fault.....	81
Appliance warranty and product registration.....	81
<b>Caring for the environment</b> .....	<b>82</b>

# IMPORTANT SAFETY INSTRUCTIONS

---

**When using the Range, please comply with the basic safety requirements, including the following instructions:**

**Read all instructions before installation and use of the Range to prevent accidents and damage to the appliance.**

This range complies with current safety requirements. However, improper use of the appliance can result in personal injury or damage to property.

Please read the installation instructions carefully before installing and connecting the appliance.

Read the operating instructions before using the range for the first time. To prevent accidents and damage to the appliance, always observe both the installation instructions and operating instructions. Both documents contain important information about installation, safety, use and maintenance.

Miele cannot be held liable for damage occurring as a result of non-compliance with the instructions.

Keep these installation instructions and operating instructions in a safe place and pass them on to any future owner.

## Appropriate use

- ▶ This range is intended for domestic use and use in other similar environments.
- ▶ This appliance is not intended for outdoor use.
- ▶ Use the range exclusively under normal domestic conditions:
  - Use the oven for baking, roasting, broiling, defrosting, canning and drying food.
  - Use the cooktop to prepare food and keep it warm.

Any other use is not permitted.

▶ Risk of Fire! Do not use this oven to store or dry combustible materials.

▶ Persons who lack physical, sensory or mental abilities, or experience with the appliance should not use it without supervision or instruction by a responsible person.

## IMPORTANT SAFETY INSTRUCTIONS

---

▶ The oven compartment is equipped with special bulbs to cope with particular conditions (e.g., temperature, moisture, chemical resistance, abrasion resistance, and vibration). These special bulbs must only be used for the purpose for which they are intended. They are not suitable for room lighting.

### **Safety with children**

▶ Activate the system lock to ensure that children cannot switch on the oven inadvertently.

▶ Children should be supervised in the vicinity of the range. Never allow children to play with the range.

▶ Children must be kept away from the range unless they are constantly supervised.

▶ Risk of burns due to improper use. Do not allow children to operate the range.

▶ Burn Hazard - Do not allow children to use the oven. Failure to do so can result in severe burns or serious injury.

▶ Burn Hazard - Do not allow children to use the cooktop. Failure to do so can result in severe burns or serious injury.

▶ Risk of suffocation from packaging material. While playing, children may become entangled in packaging material (such as plastic wrapping) or pull it over their head, presenting the risk of suffocation. Keep packaging material away from children.

▶ Risk of injury caused by hot surfaces. Children's skin is far more sensitive to high temperatures than that of adults. External parts of the oven such as the door glass, control panel, and the vent become quite hot.

Do not let children touch the oven when it is in operation.

▶ Risk of injury caused by hot surfaces. Children's skin is far more sensitive to high temperatures than that of adults. The oven gets much hotter during the Self Clean program than during normal use. Do not let children touch the oven during the Self Clean program.

▶ The cooktop gets hot when in use and remains hot for some time after being turned off. Keep children away from the appliance until it has cooled down and is no longer a burn hazard.

▶ Burn hazard!

Keep the spaces above and behind the cooktop clear of any items that could draw the attention of children. Otherwise, they can be tempted into climbing onto the appliance.

## IMPORTANT SAFETY INSTRUCTIONS

---

- ▶ Risk of burning or scalding.

Turn pot and pan handles inward, so children cannot pull them down and be burned.

- ▶ Risk of injury from the open door. The oven door can support a maximum weight of 33 lbs (15 kg). Children could injure themselves on an open door.

Do not let children sit on the door, lean against it, or swing on it.

### Technical safety

- ▶ This appliance must be installed and connected in compliance with the installation instructions.

- ▶ Unauthorized installation, maintenance, and repairs can cause considerable danger for the user. Installation, maintenance, and repairs should only be carried out by a Miele authorized technician.

- ▶ Do not carry or lift the range by the oven door handle or the control panel!

- ▶ Maintenance by the user: Never repair or replace any part of the appliance unless the instructions specifically recommend doing so. Service work should only be performed by a qualified technician.

- ▶ A damaged range can be dangerous. Always check for visible signs of damage. Never use a damaged appliance.

- ▶ Temporary or permanent operation on an autonomous power supply system or a power supply system that is not synchronized with the grid power supply (e.g., island networks, back-up systems) is possible. A prerequisite for operation is that the power supply system complies with national and local codes.

The function and operation of the protective measures provided in the domestic electrical installation and in this Miele product must also be maintained in isolated operation or in operation that is not synchronized with the grid power supply, or these measures must be replaced by equivalent measures in the installation.

- ▶ The electrical safety of the range can only be guaranteed when it is properly grounded. Compliance with this essential safety requirement is absolutely mandatory. If in any doubt, please have the building's wiring system inspected by a qualified electrician.

- ▶ Proper installation: Make sure that your appliance has been installed correctly and that it has been grounded by a qualified technician.



## IMPORTANT SAFETY INSTRUCTIONS

---

- ▶ To avoid damaging the range, make sure that the connection data (voltage and frequency) on the data plate correspond to the building's power supply before connecting the appliance. When in doubt, consult a qualified electrician.
- ▶ Do not use a power strip or extension cord to connect the range to electricity. These are a fire hazard and do not guarantee the required level of appliance safety.
- ▶ For safety reasons, only use the range when it has been fully installed.
- ▶ This range must not be installed and operated in non-stationary installations (e.g., on a ship).
- ▶ Risk of injury due to electric shock. Any contact with live connections or tampering with the electrical or mechanical components of the range will endanger your safety and may lead to appliance malfunctions.  
Do not open the range housing under any circumstances.
- ▶ Any repairs not performed by a Miele authorized service technician will void the warranty.
- ▶ Miele can only guarantee the safety of the appliance when original Miele parts are used. Faulty components must only be replaced with genuine Miele parts.
- ▶ If the power cord is damaged, it must be replaced with a special power cord by a Miele authorized technician (see "Installation – Electrical connection").
- ▶ Risk of electric shock! If the ceramic surface of the cooktop is defective or chipped, cracked or broken in any way, immediately switch the cooktop off and do not continue to use it. Disconnect the range from the power supply and contact Miele Technical Service.
- ▶ During installation, maintenance, and repair work, e.g., if the oven interior lighting is broken, the Range must be completely disconnected from the power supply (see "Frequently asked questions"). To ensure this:
  - The circuit breakers have been switched off, or
  - the fuses of the electrical installation have been completely removed, or
  - the plug (if present) is removed from the outlet. To do this, pull the plug not the cord.

## IMPORTANT SAFETY INSTRUCTIONS

---

- ▶ The range requires a sufficient supply of cool air for efficient operation. Make sure that the supply of cool air is not hindered in any way (e.g., by installing heat insulation strips in the cabinet niche). In addition, the required supply of cool air must not be excessively heated by other heat sources.
- ▶ Reaching over a hot cooktop to access the cabinets can result in burns. You can reduce the risk of burns by installing a range hood that extends at least 4 3/4" (12 cm) past the bottom of the cabinets.

### Correct use

- ▶ Caution: Heating elements may be hot even though they are not glowing. Interior surfaces of an oven become hot enough to cause burns. External parts of the oven such as the door glass, vents, and the control panel can become hot. During and after use, do not touch, or let clothing or other flammable materials come into contact with heating elements or interior surfaces of the oven until they have had sufficient time to cool.
- ▶ Do not let food sit in the oven for an extended period of time before or after cooking. Doing so can result in food poisoning or sickness.
- ▶ Loose fitting or hanging garments present a fire hazard. Wear proper apparel while operating the appliance.
- ▶ Use only dry, heat-resistant potholders. Moist or damp potholders used on hot surfaces may result in steam burns. Do not let potholders come in contact with oil or grease. Do not substitute dish towels or other bulky items for potholders. Do not let potholders touch hot heating elements.
- ▶ Open the door carefully to allow hot air or steam to escape before placing or removing food.
- ▶ To prevent burns, always place oven racks at their desired height while the oven is cool. If the rack must be moved while the oven is hot, do not let pot holders touch hot heating elements.
- ▶ To prevent burns, allow the heating elements to cool before cleaning by hand.
- ▶ Smother the fire or flames, or use a dry chemical extinguishing agent or foam fire extinguisher.
- ▶ Never store flammable liquids and materials in, above or under an oven, or near cooking surfaces.

## IMPORTANT SAFETY INSTRUCTIONS

### WARNING

NEVER use this appliance as a space heater to heat or warm the room. Doing so may result in carbon monoxide poisoning and overheating of the oven.

### WARNING

NEVER use this appliance as storage space. Doing so may result in carbon monoxide poisoning and overheating of the oven.



### WARNING

NEVER cover any slots, holes or openings in the oven bottom or cover an entire rack with materials such as aluminum foil. Doing so blocks air flow through the oven and may cause carbon monoxide poisoning. Aluminum foil linings may also trap heat, causing a fire hazard.

- ▶ Do not obstruct the flow of combustion and ventilation air.
- ▶ This oven must only be used for cooking food. Corrosive chemicals and vapors as well as fumes, vapors or heat given off by glues, plastics or flammable liquids and materials could be hazardous. Do not use it as a dryer, kiln, dehumidifier, etc.
- ▶ Do not let metal objects (aluminum foil, pans) come in contact with the heating element.
- ▶ Make certain that the power cords of small appliances do not come in contact with or get caught in the oven door.
- ▶ When baking frozen pizzas or pies, place them on the wire rack lined with parchment paper. Do not use the baking tray or the roasting pan for frozen foods with a large surface area. The tray or pan could become warped and difficult to remove from the oven when hot. Frozen foods like french fries, chicken nuggets, etc. can be baked on the baking tray.
- ▶ Risk of injury caused by hot surfaces. The oven gets hot during operation. You could burn yourself on the heating elements, oven compartment, accessories, or food. When the oven is hot, use pot holders to insert, remove, or turn food, as well as when adjusting the oven shelves, etc.

## IMPORTANT SAFETY INSTRUCTIONS

---

- ▶ To avoid fueling any flames, do not open the oven door if smoke appears inside the appliance. Interrupt the process by turning the appliance off and disconnecting it from the power. Do not open the door until the smoke has dissipated.
- ▶ The high temperatures radiated could cause objects near the oven to catch fire.  
Do not use the oven to heat the room.
- ▶ Oils and fats are a fire hazard if allowed to overheat. Never leave the oven unattended when cooking with oil or fats. Never attempt to put out oil or fat fires with water. Turn the oven off and extinguish the flames by leaving the door closed.
- ▶ Do not use water on cooktop grease fires. Turn the cooktop off. Smother or use a dry chemical or foam-type extinguisher on any fire or flame.
- ▶ Broiling food for excessively long cooking durations can cause it to dry out with the risk of catching fire. Do not exceed the recommended cooking durations.
- ▶ Certain foods dry out quickly and may catch fire due to high broiling temperatures.  
Never use broiling modes to finish baking par-cooked rolls or bread, or to dry flowers or herbs. Instead, use the Convection  (Conv Bake) or Surround  operating mode.
- ▶ If using alcohol in your recipes, please be aware that high temperatures can cause the alcohol to evaporate. The vapor can catch fire on hot heating elements.
- ▶ Plastic or aluminum foil cookware melts at high temperatures and can damage the range or start to burn. Do not use any plastic or aluminum foil cookware.  
Exception: You can use oven-safe plastic cookware in the oven. Heed the cookware manufacturer's instructions.
- ▶ When using residual heat to keep food warm, corrosion from high air humidity and condensation can occur in the oven. This can cause damage to the control panel, countertop, and cabinet carcass. Keep the oven on and select the lowest temperature available for the selected operating mode. The cooling fan will then continue to run automatically.

## IMPORTANT SAFETY INSTRUCTIONS

- ▶ Food which is stored in the oven compartment or left in it to be kept warm can dry out and the moisture released can lead to corrosion damage in the oven. Always cover food that is left in the oven to keep warm.
- ▶ A buildup of heat can cause the floor of the oven to crack or flake off.  
Never line the floor of the oven with aluminum foil or oven liners. If you wish to place dishware on the floor of the oven during the cooking process, or place dishware on the floor of the oven to heat it up, you can do so, but only with the Convection  (Conv Bake) operating mode.
- ▶ The oven floor can become damaged by items being pushed around on it. When placing pots, pans, or dishware on the oven floor, do not push them around.
- ▶ Risk of injury caused by steam. Pouring a cold liquid onto a hot surface creates steam, which can cause severe scalding. The sudden temperature change can also cause damage to hot surfaces. Never pour cold liquids directly onto hot enameled surfaces.
- ▶ It is important that the temperature in the food being cooked is evenly distributed and sufficiently high. You can ensure this by stirring or turning the food.
- ▶ Canning food and heating it up in closed containers results in an increase in pressure which can cause them to explode. Do not use cans for canning or reheating food.
- ▶ Risk of injury from the open door. You could bang into the open door or trip over it. Do not leave the door open unnecessarily.
- ▶ The door can support a maximum load of 33 lbs (15 kg). Do not lean or sit on an open door, or place heavy items on it. Make sure that nothing gets trapped between the door and the oven compartment. This could damage the oven.
- ▶ The flames could set the grease filters of a ventilation hood on fire. Do not flambé under a ventilation hood.
- ▶ Never heat empty cookware.
- ▶ If the cooktop is covered, there is a risk that the material of the cover will ignite, explode or melt if the cooktop is still hot or if turned on inadvertently. Never cover the cooktop with a board, cloth or protective sheet.

## IMPORTANT SAFETY INSTRUCTIONS

---

- ▶ When using an electric appliance, e.g. a hand mixer, near the cooktop, make sure that the power cable does not come into contact with the hot cooktop. The cable's insulation could become damaged.
- ▶ The cooktop gets hot when in use and remains hot for a while after being turned off. There is a potential hazard until the residual heat indicator goes out.
- ▶ If the cooktop is turned on or accidentally turned on or if it is still hot, metal objects on the cooktop can heat up. Other items may melt or catch fire. Damp lids can become attached to the cooktop by suction. Do not store items on the cooktop! Always turn the cooktop off after use!
- ▶ Metallic objects such as knives, forks, spoons and lids should not be placed on the cooktop surface since they can get hot.
- ▶ Do not allow solid or liquid sugar, or pieces of plastic or aluminum foil to get onto the cooktop when it is hot, as they can damage the ceramic surface when it cools down. If this should occur, turn off the appliance immediately and scrape off all the sugar, plastic or aluminum residues while still hot, using a shielded scraper blade. Use pot holders. Allow the ceramic surface to cool down before cleaning with a suitable ceramic cleaning agent.
- ▶ Pans that boil dry can cause damage to the ceramic glass. Do not leave the appliance unattended while it is being used.
- ▶ Rough bases can scratch the glass-ceramic surface. Use only pots and pans with smooth bases.
- ▶ Lift pans into position on the cooktop. Sliding them into place can cause scuffs and scratches.
- ▶ Grains of salt, sugar and sand (e.g. from cleaning vegetables) can cause scratches if they get under pan bases. Make sure that the ceramic surface is clean before placing pans on it.
- ▶ Even a light object can cause damage to the ceramic cooktop in certain circumstances. Do not drop anything on the ceramic surface.
- ▶ Hot pans on the display can cause damage to the electronics underneath. Do not place hot pans on the area around the display.
- ▶ Because induction heating works so quickly, the temperature can quickly reach the ignition point of oils and fats. Never leave the cooktop unattended when it is turned on.
- ▶ Do not heat oils and fats for longer than 1 minute, and never use the booster.

## IMPORTANT SAFETY INSTRUCTIONS

---

- ▶ For people who have a heart pacemaker: Please note that the area immediately surrounding the cooktop is electromagnetically charged. It is very unlikely to affect a pacemaker. However, if in any doubt, consult the manufacturer of the pacemaker or your doctor.
- ▶ Objects affected by electromagnetic fields, for instance credit cards, CDs and calculators, should be kept away from the cooktop when it is on.
- ▶ If residue remains on the cooktop for any length of time, it can cook into the cooktop and sometimes it is then not possible to remove it. Remove spills and splatters promptly. Also make sure that the bottom of any cookware is clean, dry, and free of grease before placing it on the cooktop.
- ▶ This cooktop is equipped with a cooling fan. If a drawer is installed directly underneath the cooktop, ensure that there is sufficient space between the drawer and its contents and the underside of the appliance in order to ensure sufficient ventilation of the cooktop. Do not store pointed or small items or paper in the drawer. They could get in through the ventilation slots or be sucked into the housing by the fan and damage the fan or impair cooling.
- ▶ Never use two pieces of cookware simultaneously on one cooking zone.
- ▶ If the cookware only partially covers the cooking zone, the handles could become very hot.  
Always place cookware in the middle of the cooking zone.
- ▶ The cooktop has cooking zones in different sizes. Only use cookware with a flat base that is large enough for the cooking zone. If the cookware is too small, it will leave part of the hot cooking zone uncovered. Coming into contact with uncovered hot cooking zones can lead to burns and may cause clothing to ignite. If you use cookware that is the right size, this will also make better use of the heated area.
- ▶ Wet sponges or cloths can cause burns due to hot steam if they are used to wipe spilled food off a hot cooktop. Some cleaning agents can emit hazardous vapors if they are applied to a hot surface. Be careful when cleaning the cooktop.
- ▶ Spilled food can cause odors and the spraying of grease, which can ignite on the cooktop. Never leave the cooktop unsupervised at high power.

## IMPORTANT SAFETY INSTRUCTIONS

---

- ▶ If the handles of the cookware protrude over a neighboring cooking zone, this can result in burns and cause flammable materials to ignite and food to spill if you accidentally come into contact with the cookware. Turn the cookware so that the handles point inward and do not protrude over a neighboring cooking zone.
- ▶ If the cooktop is damaged, cleaning agents or spilt food can penetrate the glass surface and cause a short circuit. Never cook on a damaged cooktop. Contact a qualified electrician immediately.

### **The following applies to stainless steel surfaces:**

- ▶ Adhesives will damage the coated stainless steel surface and cause it to lose its dirt-repellent protective coating. Do not use sticky notes, adhesive tape, or other types of adhesive on the stainless steel surface.
- ▶ Magnets can cause scratches. Do not use the stainless steel surface as a magnetic notice board.

### **Cleaning and care**

- ▶ Only clean parts listed in these operating and installation instructions.
- ▶ There is a delicate fiberglass seal around front of the oven compartment provide a seal for the glass on the inside of the oven door. This can be damaged by rubbing or scouring. If possible, refrain from cleaning this.
- ▶ Do not use oven cleaners. Do not use standard oven cleaners in the oven compartment or on the front of the oven. Never line the oven with oven liners.
- ▶ Risk of injury due to electric shock. The steam from a steam cleaning appliance could reach live electrical components and cause a short circuit. Never use a steam cleaner for cleaning.
- ▶ Scratches on the door glass can cause the glass to break. Do not use abrasive cleaners, hard sponges, brushes, or sharp metal tools to clean the door glass.
- ▶ The side runners can be removed (see “Cleaning and care of the oven – Removing the side runners”). Reinstall the side runners correctly.
- ▶ Coarse soiling in the oven compartment can cause thick smoke to develop. Remove coarse soiling from the oven compartment before running the Self Clean program.



## IMPORTANT SAFETY INSTRUCTIONS

---

- ▶ Risk of injury caused by hazardous steam. During the Self Clean program, steam can be released. During the Self Clean program, do not stay in the kitchen for longer periods of time and do not let children and pets enter the kitchen. It is important to ensure that the kitchen is well ventilated during the Self Clean program. Close doors to other rooms to prevent the odor spreading throughout the house.
- ▶ In warm, moist environments, there is a higher probability of pest infestations. Ensure the oven and the area surrounding it are always kept clean.  
Damage caused by pests is not covered by the warranty.

### **Accessories**

- ▶ Only use original Miele accessories. Using parts or accessories from other manufacturers will invalidate the warranty, and Miele cannot accept liability.
- ▶ Accessories that are not suitable for the Self Clean program will be damaged by the high temperatures. Remove all accessories that are not suitable for the Self Clean program from the oven compartment before starting the Self Clean process. This also applies to optional accessories that are not suitable for the Self Clean program (see “Cleaning and care of the oven”).

**KEEP THE OPERATING AND INSTALLATION INSTRUCTIONS IN A SAFE PLACE AND REVIEW THEM PERIODICALLY.**

# Guide to the range

## Induction cooktop

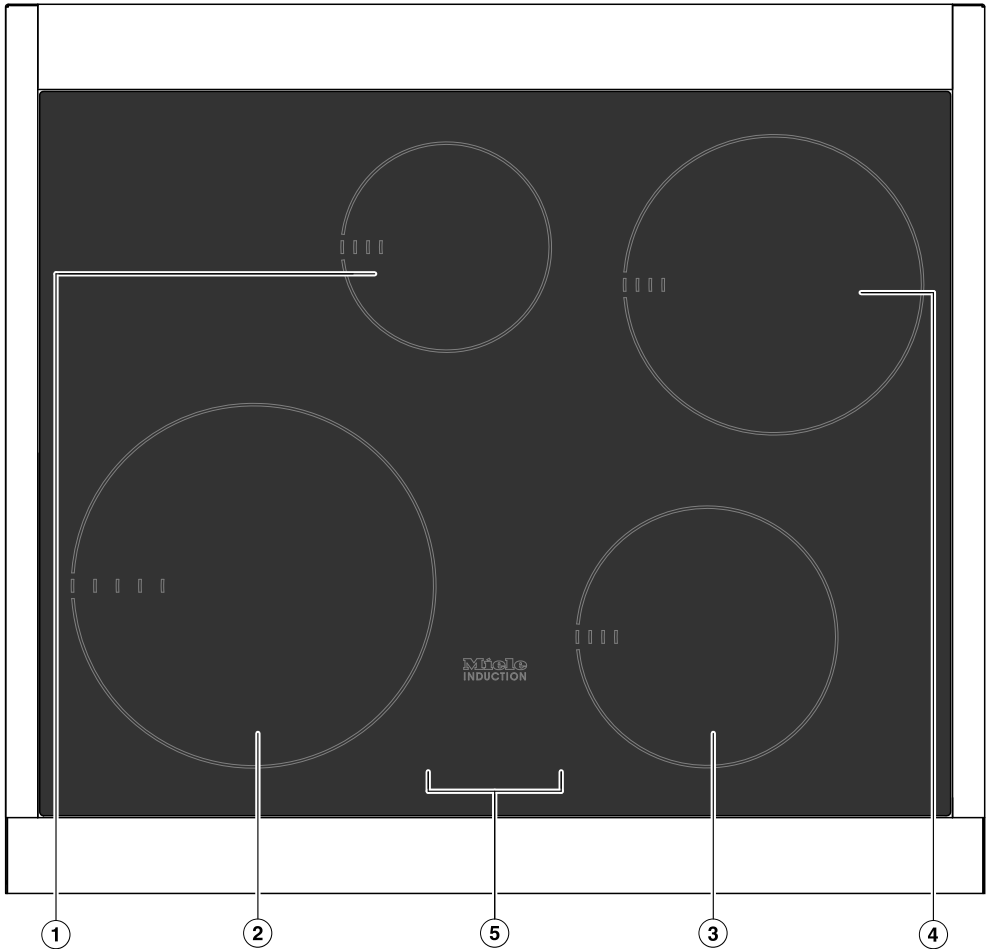

- ① Rear left cooking zone with Booster,  $\varnothing$  4"-6 1/2" (10-16 cm)
- ② Front left cooking zone with TwinBooster,  $\varnothing$  7"-11" (18-28 cm)
- ③ Front right cooking zone with Booster,  $\varnothing$  5 1/2"-8" (14-20 cm)
- ④ Rear right cooking zone with TwinBooster,  $\varnothing$  6 1/2"-9" (16-23 cm)
- ⑤ Display with cooking zone indicators

## Oven

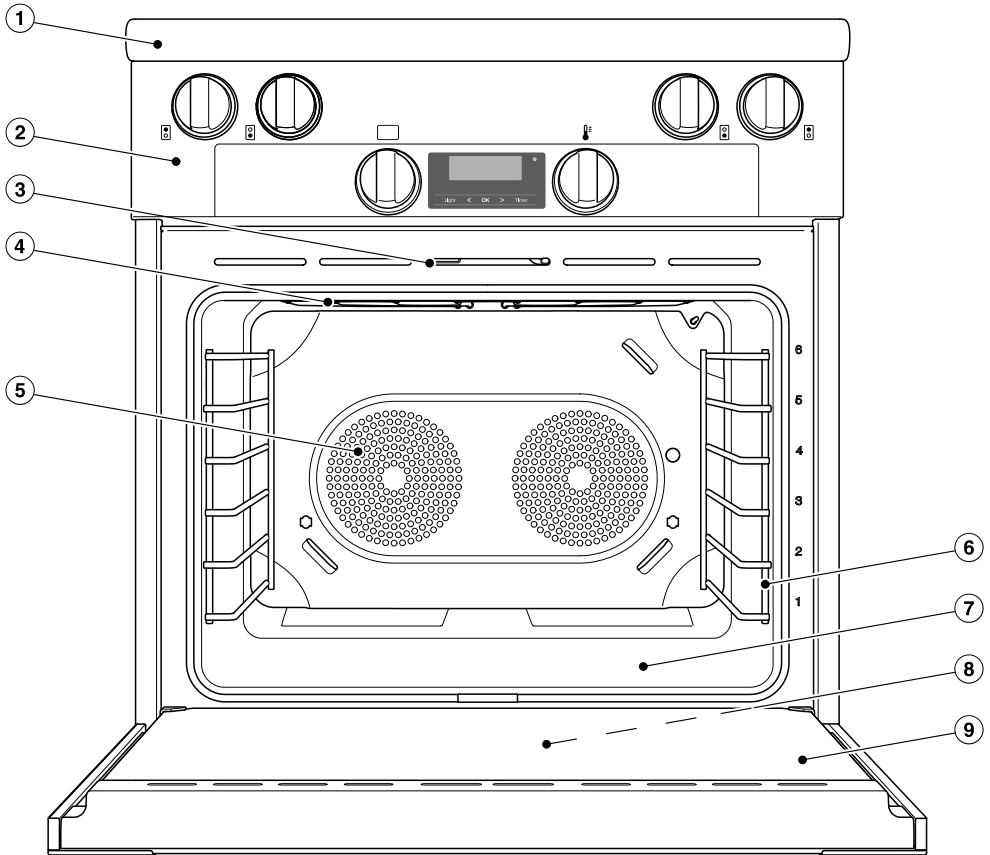

- ① Induction cooktop
- ② Controls
- ③ Door lock for Self Clean
- ④ Browning/Broiling element
- ⑤ Air inlets for the blowers with ring heating elements behind them
- ⑥ Side runners with 6 shelf levels
- ⑦ Oven floor with bottom heat element underneath it
- ⑧ Data plate  
The data plate is located behind the toe-kick panel
- ⑨ Door

# Controls for the range

---

## Control elements for the induction cooktop

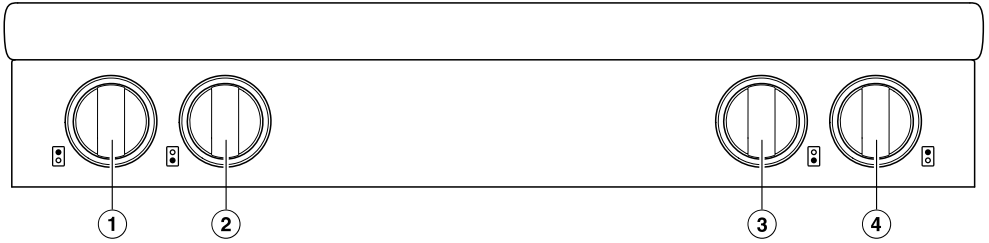

- ① Cooking zone knob  
Rear left cooking zone
- ② Cooking zone knob  
Front left cooking zone

- ③ Cooking zone knob  
Front right cooking zone
- ④ Cooking zone knob  
Rear right cooking zone

# Controls for the range

## Cooking zone knobs and display with cooking zone indicators

The cooking zone knobs must not be turned beyond *B* or *B I/II* to  $\gg$  or *O*.

The induction cooktop is operated using the cooking zone knobs and the display with cooking zone indicators.

To turn on a cooking zone, turn the knob clockwise until the desired power level appears on the cooking zone indicator.

To activate the Auto heat-up feature, turn the cooking zone knob counterclockwise to  $\gg$  and hold this position.

To turn off a cooking zone, turn the knob counterclockwise to *O*.

## Cooking zone knob symbols

Symbol	Description
<i>O</i>	Cooking zone off
$\overline{\text{III}}$	Keeping warm setting
	Level indicator
<i>B</i>	Booster (1 level)
<i>B I/II</i>	TwinBooster (2 levels)
$\gg$	Auto heat-up

## Symbols on the cooktop display

Symbol	Description
$\square$	Cooking zone ready for use
<i>h</i>	Keeping warm setting
<i>I</i> to <i>9</i>	Power level
<i>R</i>	Auto heat-up
<i>,</i>	TwinBooster level 1
<i>''</i>	Booster or TwinBooster level 2
$\underline{\text{U}}$	Cookware missing or unsuitable (see "Operating the induction cooktop")
$\equiv$	Residual heat
<i>LC</i>	System lock activated
<i>dE</i>	Demo mode activated
<i>0000</i>	Demo mode deactivated

# Controls for the range

---

## Oven controls

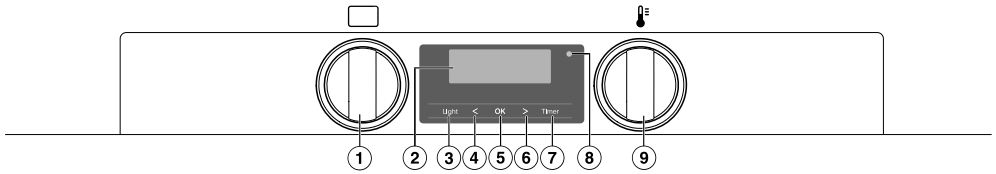

- ① Mode selector  
For selecting operating modes
- ② Clock/timer  
For displaying the time of day and settings
- ③ *Light* sensor button  
For switching the oven interior lighting on and off
- ④ < sensor button  
For changing times and settings
- ⑤ *OK* sensor button  
For accessing functions and saving settings
- ⑥ > sensor button  
For changing times and settings
- ⑦ *Timer* sensor button  
To activate or deactivate a timer
- ⑧ Optical interface  
(for Miele Service only)
- ⑨ Temperature selector  
For setting the temperature

## Temperature selector

Use the temperature selector to select the temperature for the cooking processes.

It can be turned clockwise until a resistance is felt and then turned back again to the  position.

The temperature settings on the temperature selector start at 150°F (50°C). You can also set lower temperatures between the  position and 150°F (50°C).

## Mode selector

The mode selector is used to select operating modes.

It can be turned clockwise until a resistance is felt and then turned back again to the  (Off) position.

The operating modes are printed on the mode selector.

## Operating modes

Booster 

Bake  (Bake)

Maxi Broil  (Broil)

Surround

Self clean  (Clean)

Convection Broil  (Conv Broil)

Convection  (Conv Bake)

( ) alternative mode selector labels in brackets

## Clock/timer

The clock/timer is operated via the **display** with the **sensor buttons**.

## Display

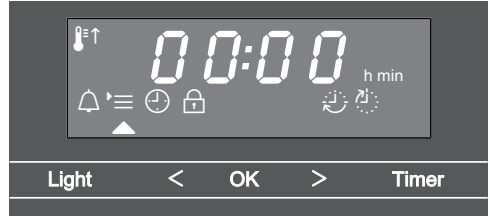







The display shows the time of day or your settings.

Please refer to “Using the oven – Operating the clock/timer” for more information.

## Symbols in the display

Depending on the position of the mode selector and/or which button is pressed, the following symbols will appear:

Symbol/function		<input type="checkbox"/>
	Timer	Any
	Temperature indicator light	Operating mode
	Cooking duration	
	End of cooking duration	
	Settings <i>P</i>	<input type="checkbox"/> (Off)
	Time	<input type="checkbox"/> (Off)
	System lock	

Mode selector position

You can only set or change a function if the mode selector is in the corresponding position.

# Controls for the range

---

## Sensor buttons

The range has the following touch-sensitive sensor buttons: *Light*, *<*, *OK*, *>*, and *Timer*. Every touch on the sensor buttons is confirmed by a keypad tone.

The keypad tone can be switched off by changing setting *P 4* to status *5 1* (see “Using the oven – Operating the clock/timer”).

## Temperature indicator light

The temperature indicator light  lights up when the oven is heating.

As soon as the selected temperature is reached, the oven heating switches off and the temperature indicator light goes out.

The temperature control unit ensures that the oven heating and the temperature indicator light switch back on if the oven temperature falls below the level set.



The models described in these operating instructions can be found at the end.

## Data plate

The data plate is located behind the toe kick panel. The toe kick panel is attached to the toe kick of the Range by magnets so it can be removed and put back again easily.

There you can find the model number, serial number and the connection data (voltage/frequency/maximum rated load) for your Range.

Have this information available if you need to contact Miele so that any issues can be rectified as quickly as possible.

## Scope of delivery

- Installation instructions for the range
- Operating instructions for the range, for using the cooktop and oven functions
- Anti-tip device including screws for securing the range
- Various accessories

## Standard and optional accessories

Features will vary depending on model.

The side runners, universal tray, and wire rack (or “rack” for short) are supplied as standard with the oven.

Depending on the model, your oven may also come supplied with some of the accessories listed here.

All the accessories listed as well as the cleaning and care products are designed for Miele Ranges.

These can be ordered from the Miele web store, Miele Customer Service, or from your Miele dealer.

When ordering, please quote the model number of your range and the reference number of the accessories required.

## Side racks

Side racks for accessories are installed on either side of the oven compartment for shelf levels  $\square_1^6$ .

If necessary, install the side racks on the right and left of the oven compartment (see “Initial commissioning”).

The shelf level numbers are indicated on the front of the oven frame.

Each level consists of a rail on which you can place the wire rack, for example.

You can remove the side racks (see “Cleaning and care of the oven – Side rack removal”).

## Universal tray and Wire Rack with anti-tip safety notches

Universal tray HUBB 30-1:

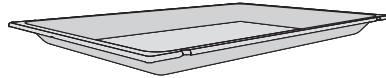

Wire Rack HBBR 30-2:

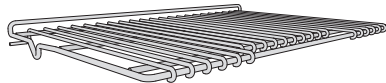

Safety notches are located on the short edges of the Wire Rack. These prevent the Wire Rack from being fully pulled out of the side racks when it only needs to be pulled partially out.

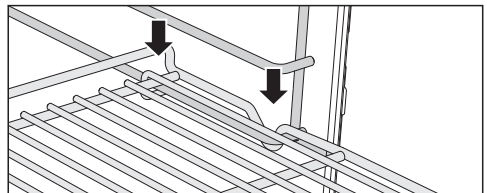

Always slide the Wire Rack into the rails of the side racks with the catches facing down.

## Features

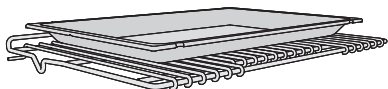

**Tip:** When using the universal tray, place it directly on the Wire Rack.

### FlexiClips with Wire Rack HFCBBR 30-3

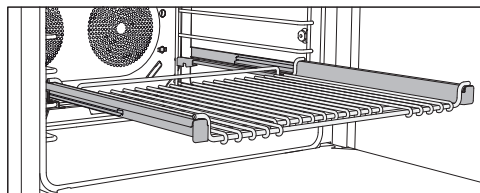

The FlexiClips with Wire Rack are mounted on the side racks and can be pulled completely out of the oven. This allows you to see the food easily.

The FlexiClips with Wire Rack are pushed onto the rails of a level and then locked into place.

The FlexiClips can support a maximum load of 33 lb (15 kg).

The FlexiClips with Wire Rack can be mounted on any shelf level.

### Installing and removing the FlexiClips with Wire Rack

 **Danger of injury caused by hot surfaces.**

The oven gets hot during operation. You could burn yourself on the heater elements, oven compartment, or accessories.

Allow the heating elements, oven compartment, and the accessories to cool down before installing or removing the FlexiClips with Wire Rack.

When installing or removing the FlexiClips, **do not** extend them.

- Hold the FlexiClips with Wire Rack with both hands and position them in front of the desired level.

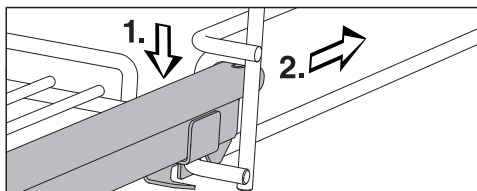

- Insert the FlexiClips with Wire Rack onto the level (1.) and slide them along the struts of the level (2.) until they click into place.

If the FlexiClips are difficult to pull out after installing, you may need to pull firmly on them once to release them.

**Tip:** When using the universal tray, place it directly on the FlexiClips with Wire Rack.

To remove the FlexiClips with Wire Rack, proceed as follows:

- Push the FlexiClips with Wire Rack in all the way.

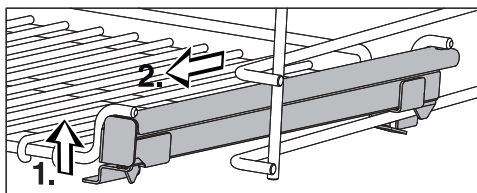

- Lift the front of the FlexiClips with Wire Rack on both sides (1.) and pull them out of the level (2.).

### Temperature selector with °C scale

The range is delivered with a temperature selector with °F scale. The temperature selector with °C scale is available as an optional accessory. Please quote the model designation of the range when ordering.

## Replacing the temperature selector

Do not operate the range without a temperature selector installed.

- Turn the temperature selector to the  position.
- Pull the temperature selector off the range horizontally.
- Install the new temperature selector in the same position by pushing it onto the range.

## Round baking pans



The **solid round baking pan HBF 27-1** is suitable for cooking pizzas, flat cakes made with yeast, or whisked mixtures, sweet and savory tarts, baked desserts, flat bread, and can also be used for frozen cakes and pizzas.

The **perforated round baking and AirFry pan HBFP 27-1** can be used for the same purposes as the **perforated Gourmet baking and AirFry tray HBBL 71**.

The enameled surface of both bakeware pans has been treated with PerfectClean.

- Insert the wire rack and place the round baking pan on the wire rack.

## Gourmet baking and AirFry tray, perforated HBBL 71



The fine perforations of the Gourmet baking and AirFry tray optimize cooking processes:

- Browning on the underside of baked goods made from fresh yeast and quark doughs as well as bread and rolls is improved.  
Roll out the dough on a level surface first and then place it on the perforated Gourmet baking and AirFry tray.
- French fries, croquettes, or similar items can be fried in a low-fat air flow (AirFrying).
- During dehydrating/drying, the air circulation around the food for drying is optimized.

The enameled surface has been treated with PerfectClean.

The **round perforated baking and AirFry tray HBFP 27-1** can be used for the same purposes.

- Insert the wire rack and place the perforated Gourmet baking and AirFry tray on the wire rack.

## Broiling and roasting insert HGBB 30-1

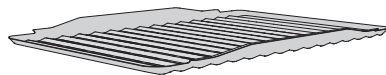

The broiling and roasting insert fits in the universal tray.

When broiling, roasting, or AirFrying, the tray will collect meat juices and stop them from burning so that they can be used for making gravy and sauces.

The enameled surface has been treated with PerfectClean.

# Features

## HUB Gourmet Casserole Dishes HBD Gourmet Casserole Dish lids

Miele Gourmet Casserole Dishes can be placed directly on the wire rack. The surface of the casserole dishes has a non-stick coating.

Gourmet Casserole Dishes are available in different depths. The width and the height are the same.

Suitable lids are available separately. Please quote the model designation when ordering.

**Depth:**  
**8 1/2" (22 cm)**

HUB 62-22\*

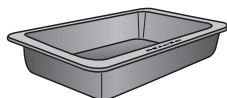

HBD 60-22

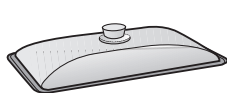

**Depth:**  
**13 3/4" (35 cm)**

HUB 62-35\*

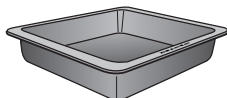

HBD 60-35

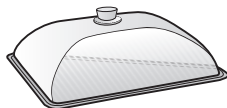

\* Suitable for use on induction cooktops

## Accessories for cleaning and care

- Opener

The opener is used for removing the cover from the oven lighting.

## Safety features of the induction cooktop

### Using the system lock

The system lock prevents the cooking zones from being turned on inadvertently.

The system lock can only be activated if all cooking zones are turned off.

- Turn all cooking zone knobs counterclockwise to 0.
- To **activate** the **system lock**, turn the knobs for the two front cooking zones all the way to the left at the same time and hold them until **LL** appears.

If a power level is selected when the system lock is activated, **LL** appears on the display for a few seconds.

- To **deactivate** the **system lock**, turn the knobs for the two front cooking zones all the way to the left at the same time and hold them until **LL** goes out.

The system lock is deactivated if there is a power outage.

## Safety shut-off

The safety shut-off mechanism is triggered automatically if a cooking zone is heated for an unusually long period of time. This time depends on the power level selected. If the time has been exceeded, the cooking zone turns off and the residual heat indicator appears. If you turn the cooking zone off and on again, it will be ready for operation again.

## Residual heat indicator

If the cooking zone has been turned off but is still hot, the residual heat indicator appears on the cooking zone indicator. The last horizontal bar only goes out when the cooking zone is safe to touch.

## Pan/pan size recognition

The **U** symbol will flash on the cooking zone indicator of a cooking zone that is turned on in the following situations:

- There is no cookware on the cooking zone.
- The base diameter of the cookware is too small.
- The cookware is unsuitable.

The cookware is not recognized and the cooking zone turns off automatically after 3 minutes (see “Operating the induction cooktop – How induction works”).

## Using demo mode

Demo mode can only be activated for dealers if all cooking zones are turned off.

This function enables the cooktop to be demonstrated in dealer showrooms without heating up. Do not activate this setting for domestic use.

- To **activate demo mode**, turn and hold the knob for the front left cooking zone counterclockwise.
- While holding the (front left) cooking zone knob counterclockwise, turn the knob for the front right cooking zone briefly counterclockwise twice and then hold it counterclockwise until *dE* appears on the display.

If a power level is selected when demo mode is activated, *dE* appears on the display for a few seconds. The cooking zones do not heat up.

- To **deactivate demo mode**, turn and hold the knob for the front left cooking zone counterclockwise.
- While holding the (front left) cooking zone knob, turn the knob for the front right cooking zone briefly counterclockwise twice and then hold it counterclockwise until *0000* appears on the display.

## Overheating protection

All the induction coils and the heat sinks for the electronics are equipped with an overheating protection mechanism. Before the induction coils or heat sinks get too hot, the overheating protection mechanism intervenes in one of the following ways:

- Any Booster function in operation will be turned off.
- The power level that is set will be reduced.
- One or more cooking zones will turn off automatically.

Turn the knobs for all the affected cooking zones to *0*. The affected cooking zones can only be used again as normal once the induction coil or heat sink has cooled down to a safe level.

The overheating protection mechanism can be triggered in the following cases:

- Cookware is heated up while empty.
- Fat or oil is being heated on a high power level.
- A hot cooking zone is turned back on after a power outage.

If the overheating protection mechanism is triggered again even after the cause has been eliminated, contact Miele Service.

## Oven safety features

- **System lock**  for the oven (see “Using the oven – Operating the clock/timer”)

- **Cooling fan**

The cooling fan will come on automatically when a cooking program is started. It ensures that the hot air in the oven compartment is mixed with cool ambient air and thus cooled

## Features

---

before it is expelled via the gap between the door and the control panel.

The cooling fan will continue to run for a while after the oven has been turned off to prevent any humidity building up in the oven, on the control panel, or in the cabinet carcass.

The cooling fan will switch itself off automatically after a certain period of time.

### - **Safety shut-off**

This safety shut-off is activated automatically if the oven has been operating for an unusually long period of time. The period of time will depend on the particular operating mode being used.

### - **Ventilated door**

The oven door is made of glass panes that have a heat-reflective coating on part of their surface. When the oven is operating, air is passed through the door to keep the outer pane cool.

You can remove the door for cleaning purposes (see “Cleaning and care of the oven”).

### - **Door locking for Self Clean**

At the beginning of a Self Clean program, the door will lock for safety reasons. The door will only unlock when the temperature in the oven compartment has dropped to below 535°F (280°C).

## **PerfectClean treated surfaces**

PerfectClean surfaces have very good non-stick properties making them exceptionally easy to clean.

Food can be easily removed from these surfaces. Soiling from baking and roasting can also be easily removed from these surfaces.

Food can be sliced or cut up on PerfectClean surfaces.

However, do not use ceramic knives as these will scratch the PerfectClean surface.

Surfaces treated with PerfectClean enamel can be cleaned as you would clean glass.

Read the instructions in “Cleaning and care” so that the benefits of the non-stick properties and easy cleaning are retained.

PerfectClean treated surfaces:

- Universal tray
- Broiling and roasting insert
- Gourmet baking and AirFry tray, perforated
- Round baking pan
- Round perforated baking and AirFry tray

## **Self-Clean-ready accessories**

See “Cleaning and care of the oven” for more information.

The following accessories can be left in the oven compartment during the Self Clean program:

- Side runners
- FlexiClips with Wire Rack
- Wire rack

## Before using for the first time

 Danger of injury caused by hot surfaces.  
The range gets hot during operation.  
For safety reasons, only use the range when it has been fully installed.

The time of day can only be changed when the mode selector is at  (Off).

- Set the time of day.

## Setting the time of day for the first time

The time of day is shown in 12-hour clock format.

After connecting the range to the electrical supply *12:00* will appear in the display and the triangle ▲ will flash under :



- Use < or > to set the time of day.
- Confirm with *OK*.

The time of day is now saved.

The time of day can be displayed in 24-hour format by setting *P 4* in the settings menu to status *24h* (see “Using the oven – Operating the clock/timer”).

The time of day is saved for approx. 150 hours in the event of a power failure. If the power is restored within this period, the current time will be displayed again. If the power supply is interrupted for longer, the time of day must be reset.

The time of day display (*P 1*) is switched off by default (see “Using the oven – Operating the clock/timer”). The display appears dark if the oven is switched off. The time of day continues to run in the background.

# Initial commissioning

## Cleaning the cooktop before heating it up for the first time

The metal components have a protective coating. The cooktop may have a slight odor and give off vapor when heated up for the first time.

Heating the induction coils can also cause unpleasant odors in the first few hours of operation. With each subsequent use, the odors are reduced until they disappear completely.

Any odors or vapors given off do not indicate a faulty connection or appliance and they are not hazardous to health.

Please note that the heating-up time on induction cooktops is much shorter than on conventional cooktops.

- Remove any adhesive labels or protective films from the cooktop.
- Before heating the cooktop up, wipe it with a damp cloth to remove any dust or bits of leftover packaging.

## Installing the side racks and heating up the oven for the first time

New ovens may have a slight odor when they are heated up for the first time. Heating up the oven for at least an hour with nothing in it will eliminate the odor.

Ensure that the kitchen is well ventilated while the appliance is being heated up for the first time. Close doors to other rooms to prevent the odor spreading throughout the house.

- Remove any adhesive labels or protective films from the oven and accessories.

- Before heating the oven up, wipe the interior with a damp cloth to remove any dust or bits of packaging that may have accumulated in the oven compartment.
- If necessary, install the side racks on the right and left of the oven compartment:

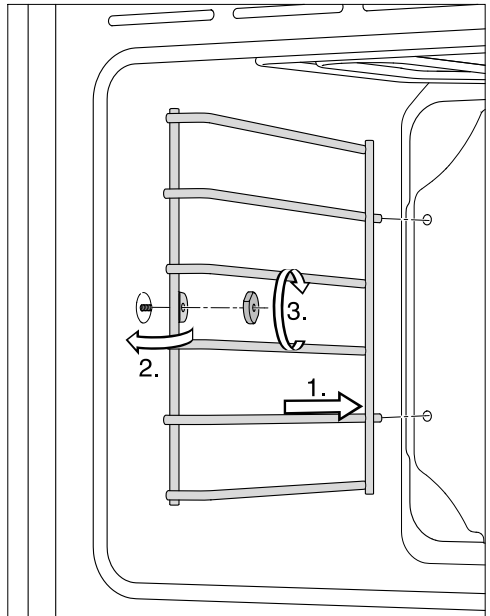

- Insert the side racks into the two openings in the rear panel of the oven compartment (1.).
- Slide the lug over the pin in the wall of the oven compartment (2.).
- Screw the knurled screw onto the pin and secure the side racks in place (3.).
- Repeat the process for the side racks on the other side.
- Insert the fully telescopic runners with wire rack into the side racks and place all trays and the rack in the oven.





- Select the Convection  (Conv Bake) operating mode.

The oven interior lighting and the fan will switch on.

- Set the maximum temperature (500°F).

The oven heating will switch on.

- Heat up the oven for at least an hour.
- After heating up, turn the mode selector to  (Off).
- After heating up, turn the temperature selector to .

## Cleaning the oven compartment after heating it up for the first time

 Risk of injury caused by hot surfaces.

The oven gets hot during operation. You could burn yourself on the heating elements, oven compartment, or accessories.

Allow the heating elements, oven compartment, and accessories to cool before manual cleaning.

- Take all accessories out of the oven compartment and clean it by hand (see “Cleaning and care of the oven”).
- Clean the oven compartment with warm water and liquid dish soap, applied with a soft sponge or microfiber cloth.
- Dry all surfaces with a soft cloth.

Leave the oven door open until the oven compartment is completely dry.

# Operating the induction cooktop

---

## How induction works

An induction coil is located under each cooking zone. When a cooking zone is switched on, this coil creates a magnetic field which impacts directly on the base of the cookware and heats it up. The cooking zone itself is heated up indirectly by the heat given off by the cookware.

You will require cookware with a magnetic base (see “Cookware”). Induction automatically recognizes the size of the cookware.

On the cooking zone indicator, the  symbol will flash alternately with the selected power level if:

- The cooking zone has been turned on without cookware in place, or the cookware is unsuitable (cookware with non-magnetic base).
- The base diameter of the cookware used is too small.
- The cookware is removed from a cooking zone that is on.

If suitable cookware is placed on the cooking zone within 3 minutes, the  symbol goes out, and you can continue as usual.

If no cookware or unsuitable cookware is used, the cooking zone will automatically turn off after 3 minutes.

### Danger of burning!

When the cooktop is switched on either deliberately or by mistake, or when there is residual heat present, there is the risk of metal items placed on the cooktop heating up.

Do not store items on the cooktop. Turn off the cooking zones after use by turning the corresponding knobs counterclockwise to 0.

## Cookware

**Suitable** cookware is made of:

- stainless steel with a magnetic base
- enameled steel
- cast iron

**Unsuitable** cookware is made of:

- stainless steel without a magnetic base
- aluminum or copper
- glass, ceramic, earthenware, stoneware

To test whether a pot or pan is suitable for use on an induction cooktop, hold a magnet to the base of the pan. If the magnet sticks, the cookware is generally suitable.

If unsuitable cookware is used, the  symbol will flash alternately with the selected power level on the cooking zone indicator.

The composition of the pan base can affect the evenness of the cooking results (e.g., when making pancakes).

- To make optimum use of the cooking zones, choose cookware with a suitable base diameter (see “Cooking zone data”). If the pot is too small, it will not be detected and the  symbol will flash alternately with the selected power level on the cooking zone indicator.
- Use only pots and pans with smooth bases. Rough bases can scratch the glass-ceramic surface.
- Always lift the cookware to move it. This will help prevent scratching.
- Please note that the pot or pan diameter quoted by manufacturers often refers to the maximum diameter or diameter of the top rim. The diameter of the base (generally smaller) is more important.

## Noises

When using induction cooking zones, the following noises can occur in the cookware, depending on what it is made of and how it has been constructed:

- On the higher power levels, it might buzz. This will decrease or cease altogether when the power level is reduced.
- Cookware with bottoms made of different materials (e.g., sandwich bottoms) may produce a crackling noise.
- Whistling may occur if connected cooking zones (see “Booster”) are simultaneously in use and cookware with bottoms made of different materials (e.g., sandwich bottoms) is placed on them.
- The electronics may produce a clicking sound, especially at lower power levels.
- You may hear a whirring sound when the cooling fan turns on. It turns on to protect the electronics when the cooktop is being used intensively. The fan may continue to run after the cooktop has been turned off.

## Energy-saving tips

- Cook in covered pots and pans if possible. This prevents heat escaping unnecessarily.
- Use small pots for small quantities. A smaller pot requires less energy than a larger, partially filled pot.
- Cook with as little water as possible.
- Once food has come to the boil or the pan is hot for frying, reduce the heat to a lower power level.
- Use a pressure cooker to reduce cooking durations.

# Operating the induction cooktop

## Cooking zone data

Cooking zone	Minimum to maximum $\varnothing$ *	Setting	Output in watts**	
			208 V, 60 Hz	240 V, 60 Hz
Front left	7"-11" (18-28 cm)	Normal	2,350	2,700
		TwinBooster, level 1	2,700	3,100
		TwinBooster, level 2	3,350	3,850
Rear left	4"-6 1/2" (10-16 cm)	Normal	1,250	1,450
		Booster	2,000	2,300
Rear right	6 1/2"-9" (16-23 cm)	Normal	2,100	2,400
		TwinBooster, level 1	2,700	3,100
		TwinBooster, level 2	3,350	3,850
Front right	5 1/2"-8" (14-20 cm)	Normal	1,700	1,950
		Booster	2,700	3,100
			<b>Total: 6,700</b>	<b>Total: 7,700</b>

\* Pots and pans with any base diameter within the given range may be used.

\*\* The wattage quoted may vary depending on the size and material of cookware used.

# Operating the induction cooktop

## Turning on the induction cooktop

Do not heat empty pans on the cooktop as this can damage the glass-ceramic surface.  
Never leave the cooktop unattended when it is turned on.

Hot items placed down on the display can damage the electronics underneath.  
Never place hot pots or pans in the area of the display.

The cooking zone knobs must not be turned beyond *B* or *B I/II* to  $\gg$  or *O*.  
You can select a power level between *1* and *9*.

- Turn the cooking zone knob clockwise.

The cooking zone indicator shows the desired power level for the selected cooking zone.

## Auto heat-up

When Auto heat-up is activated, the cooking zone turns on automatically at the highest power level and then switches to the continued cooking level that you have previously selected. The heat-up time depends on which continued cooking level has been chosen (see table).

## Activating Auto heat-up

- Turn the cooking zone knob counterclockwise to the  $\gg$  symbol and hold it there until *H* flashes once.

- Turn the cooking zone knob clockwise until the desired continued cooking level is displayed on the cooking zone indicator.

During the heat-up time, *H* flashes on the cooking zone indicator alternately with the continued cooking level.

Changing the continued cooking level during the heat-up time deactivates Auto heat-up.

## Deactivating Auto heat-up

- Select a different power level during the heat-up time.

Auto heat-up will be deactivated.

Continued cooking level	Heat-up time [min : sec]
<i>1</i>	Approx. 0 : 15
<i>2</i>	Approx. 0 : 15
<i>3</i>	Approx. 0 : 25
<i>4</i>	Approx. 0 : 50
<i>5</i>	Approx. 2 : 00
<i>6</i>	Approx. 5 : 50
<i>7</i>	Approx. 2 : 50
<i>8</i>	Approx. 2 : 50
<i>9</i>	—

# Operating the induction cooktop

---

## Using the power levels

These settings should only be taken as a guide. The power of the induction coils will vary depending on the size and material of the cookware. For this reason, it is possible that the power levels will need to be adjusted slightly to suit your cookware.

As you use the cooktop, you will get to know which settings suit your cookware best.

	Power level
Keeping warm	<i>h</i>
Melting butter Dissolving gelatin Melting chocolate	<i>1-2</i>
Making pudding	<i>2</i>
Reheating small quantities Cooking rice	<i>3</i>
Defrosting frozen vegetables	<i>3</i>
Making oatmeal	<i>3</i>
Warming liquid and semi-solid foods Making omelettes or lightly fried eggs Steaming fruit	<i>4</i>
Cooking dumplings	<i>4</i>
Steaming vegetables or fish	<i>5</i>
Defrosting and reheating frozen food	<i>5</i>
Gently frying eggs (without overheating the fat)	<i>6</i>
Bringing large quantities of food to a boil, e.g., casseroles. Thickening custard and sauces, e.g., hollandaise	<i>6-7</i>
Gently frying meat, fish, or sausages (without overheating the fat)	<i>6-7</i>
Frying pancakes, potato fritters, etc.	<i>7</i>
Braising for stews	<i>8</i>
Boiling large quantities of water Bringing to a boil	<i>9</i>

## Booster

The cooking zones are equipped with a one-level Booster or two-level TwinBooster (see “Guide to the range – Induction cooktop”).

When the Booster is activated, the power is boosted so that large quantities can be heated up quickly, e.g., when boiling water for cooking pasta.

The boost in power is active for a maximum of 15 minutes.

The Booster can be used on a maximum of two cooking zones at the same time. When the Booster time has elapsed, the cooking zone will revert automatically to the highest power level.

The cooking zones are connected in pairs in order to provide sufficient power for the Booster.

While the Booster is in operation, some of the power is taken away from the linked cooking zone. This has one of the following effects:

- Auto heat-up is deactivated.
- The power level is reduced.
- The linked cooking zone is turned off.

## Activating the Booster

- Turn the cooking zone knob clockwise gently past the point of resistance to *B* and back again as far as it will go.

„ appears on the cooking zone indicator.

## Activating TwinBooster at level 1

- Turn the cooking zone knob clockwise gently past the point of resistance to *B I/II* and back again as far as it will go.

, appears on the cooking zone indicator.

## Activating TwinBooster at level 2

- Turn the cooking zone knob clockwise gently past the point of resistance to *B I/II* and back again as far as it will go.
- Turn the cooking zone knob again gently past the point of resistance to *B I/II* and back again as far as it will go.

„ appears on the cooking zone indicator.

## Deactivating Booster/TwinBooster

- Select a different power level.

The Booster symbol goes out.

## Keeping warm

The Keeping warm setting is for keeping food warm that has just been cooked, i.e., food that is still hot. It is not for reheating cold food.

All cooking zones have a Keeping warm setting .

If the Keeping warm setting has been activated, the cooking zone will turn off automatically after a maximum of 2 hours.

## Setting the Keeping warm setting

- Turn the cooking zone knob clockwise to .

h appears on the cooking zone indicator.

## Tips

- Only use cookware (pots/pans) for keeping food warm. Cover the cookware with a lid.
- It is not necessary to stir the food while it is being kept warm.

# Operating the induction cooktop

---

- Foods begin to lose their nutrients during the cooking process and continue to do so while being kept warm. The longer food is kept warm, the greater the loss of nutrients. Try to ensure that food is kept warm for as short a time as possible.

## Turning the induction cooktop off



Risk of burning due to hot cooking zones.

The cooking zones will be hot after use.

Do not touch the cooking zones while the residual heat indicators are on.

- Turn the cooking zone knob counterclockwise to *O*.

The power level displayed on the cooking zone indicator will go out. The cooking zone is turned off.

- If the cooking zone has been turned off but is still hot, the residual heat indicator  appears on the cooking zone indicator.







## Residual heat indicator

The  bars in the residual heat indicator go out one by one as the cooking zones cool down.

The last horizontal bar only goes out when the cooking zones are safe to touch.



## Overview of operating modes



Operating modes	Range
Booster 	85–500 °F (30–250 °C)
Bake  (Bake)	85–500 °F (30–250 °C)
Maxi Broil  (Broil)	Broil
Surround 	85–500 °F (30–250 °C)
Self clean  (Clean)	–
Convection Broil  (Conv Broil)	85–500 °F (30–250 °C)
Convection  (Conv Bake)	85–500 °F (30–250 °C)

( ) alternative mode selector labels in brackets

## Energy-saving tips

### Cooking programs

- Remove all accessories from the oven that are not required for a cooking process.
- If a temperature range is given, it is best to select the lower temperature and check the food after the shortest cooking time given.
- Preheat the oven only if instructed to do so in the recipe.
- Try not to open the door when cooking.

- It is best to use dark bakeware and cooking containers with a matte finish made of non-reflective materials (enameled steel, heat-resistant glass, non-stick coated cast aluminum). Shiny materials such as stainless steel or aluminum reflect the heat and therefore can give a more uneven result. Do not cover the oven floor or the Wire Rack with heat-reflecting aluminum foil.
- Monitor cooking durations to avoid wasting energy when cooking. Set the cooking duration, or use a food probe if you have one.
- The Convection  (Conv Bake) operating mode can be used for cooking many types of food. Because the blower distributes the heat in the oven compartment straight away, it allows you to use a lower temperature than you would with Surround . It also enables you to cook on multiple shelf levels at the same time.
- Convection Broil  (Conv Broil) is the best operating mode for broiled dishes. Lower temperatures can be used than with other broil modes that use the maximum temperature setting.
- Whenever possible you should cook several dishes at the same time. Place them next to each other in the oven or on different shelf levels.
- Dishes which you are unable to prepare at the same time should, if possible, be cooked one after the other in order to make use of existing heat in the oven.

# Using the oven

## Residual heat utilization

- The temperature in cooking programs using temperatures above 285°F (140°C) which take longer than 30 minutes to cook can be turned down to the lowest possible temperature about 5 minutes before the end of cooking. The residual heat in the oven is sufficient for cooking the food until it is done. However, do not turn the oven off (see “IMPORTANT SAFETY INSTRUCTIONS”).
- It is best to start the Self Clean program immediately after a cooking program. The residual heat in the oven will help reduce the amount of energy required.

## Energy-saving mode

The oven will turn itself off automatically to save energy if a program is not being run and no controls have been operated. The time of day will appear on the display or the display will remain dark (see “Operating the clock/timer”).

## Simple operation



- Place the food in the oven.
- Select the required operating mode with the mode selector.

The oven interior lighting and the fan will switch on.

- Select the temperature with the temperature selector.

The oven heating will switch on.



After the cooking program:

- Turn the mode selector to  (Off) and the temperature selector to .
- Take the food out of the oven.

## Preheating the oven

The Booster  operating mode is used to quickly pre-heat the oven.

The oven compartment only needs to be preheated in a few cases.

- You can place most dishes in the cold oven compartment to make use of the heat produced during the heating-up phase.
- Preheat the oven when cooking the following food with the following operating modes:
  - dark bread dough and beef sirloin joints and fillet with the Convection  (Conv Bake) and Surround  operating modes
  - cakes and pastries with a short cooking duration (approx. 30 minutes or less) as well as delicate items (e.g., sponge) with the Surround  operating mode

## Using Booster

You can shorten the heating-up phase with the Booster  function.

Do not use the Booster  operating mode to pre-heat the oven when baking pizzas or delicate mixtures (e.g., sponge cake, cookies). This food will otherwise brown too quickly from the top.

- Select Booster .
- Select the temperature.
- Change to the required operating mode after the set temperature has been reached.
- Place the food in the oven.

## Operating the clock/timer

### Switching cooking programs on and off automatically

Cooking programs can be switched on or off automatically.

To do this, set a cooking duration or a cooking duration and a finish time after selecting the operating mode and temperature.

The maximum duration which can be set for a cooking program is 11 hours and 59 minutes.

It is recommended to switch on and off automatically when roasting.

If used for baking, do not delay the start for too long. Otherwise the cake mixture or dough will dry out, and the raising agents will lose their effectiveness.

### Setting the cooking duration

Example: a cake needs to bake for 1 hour and 5 minutes.

- Place the food in the oven.
- Select the required operating mode and the temperature.

The oven heating, lighting, and cooling fan will turn on.

- Select *OK*.
- If necessary, use < or > to move the triangle ▲ until it appears under ⌚.
- Confirm with *OK*.

00:00 h will appear in the display with the triangle ▲ flashing under ⌚.



- Use < or > to set the cooking time (01:05).
- Confirm with *OK*.

The cooking duration is now saved and will count down in minutes until the last minute, which will count down in seconds.

The ⌚ symbol indicates that a cooking duration has been set.

### Setting a cooking duration and a finish time

Example: the current time of day is 11:15 am; a roast with a cooking duration of 90 minutes needs to be ready at 1:30 pm.

- Place the food in the oven.
- Select the required operating mode and the temperature.

The oven heating, lighting, and cooling fan will turn on.

### First set the cooking duration:

- Select *OK*.
- If necessary, use < or > to move the triangle ▲ until it appears under ⌚.
- Confirm with *OK*.

00:00 h will appear in the display with the triangle ▲ flashing under ⌚.

- Use < or > to set the cooking time (01:30).
- Confirm with *OK*.

The cooking duration ⌚ is saved and then counts down in minutes:



## Using the oven

### Then set the finish time:

- Move the triangle ▲ with < or > until it appears under .

-:- appears:



- Confirm with *OK*.

12:45 (current time of day + cooking duration = 11:15 + 1:30) appears in the display:



- Use < or > to set the end of the cooking time (13:30).
- Confirm with *OK*.

The finish time  is now saved:



The oven heating, lighting and cooling fan will switch off.

As soon as the start time (13:30 - 1:30 = 12:00) has been reached, the oven heating, lighting and cooling fan will switch on.

### At the end of the cooking duration:

- 0:00 appears.
-  flashes.
- The oven heating switches off automatically.
- The cooling fan continues to run.
- An audible signal will sound if the audible signal is switched on.

- Turn the mode selector to  (Off).
- Turn the temperature selector to .
- Take the food out of the oven.

If the dish is not cooked to your satisfaction you can prolong the cooking duration by entering a new duration.

### Changing the cooking duration

- Select *OK*.
- If necessary, use < or > to move the triangle ▲ until it appears under .

The remaining cooking duration will appear in the display.

- Confirm with *OK*.
- Change the cooking time with < or >.
- Confirm with *OK*.

The changed cooking duration is now saved.

## Deleting a cooking duration

- Select *OK*.
- If necessary, use < or > to move the triangle ▲ until it appears under .
- Confirm with *OK*.

The triangle ▲ flashes under .

- Use < to set the cooking time to 00:00.
- Confirm with *OK*.

The cooking duration and any finish time set are deleted.

- Select *OK*.

The actual temperature will appear. The oven heating remains switched on.

If you want to end the cooking program:

- Turn the mode selector to  (Off).
- Turn the temperature selector to .
- Take the food out of the oven.

If the mode selector is turned to the  (Off) position, the settings for cooking duration and end of cooking duration will be deleted.

## Deleting a finish time

- Select *OK*.
- If necessary, use < or > to move the triangle ▲ until it appears under .
- Confirm with *OK*.

The triangle ▲ flashes under .

- Use < or > to set the end of the cooking time to -:-:-.
- Confirm with *OK*.

The finish time is deleted.

## Changing the time of day

The time of day can only be changed when the mode selector is at  (Off).

- Turn the mode selector to  (Off).
- Select *OK*.
- Move the triangle ▲ with < or > until it appears under .
- Confirm with *OK*.

The triangle ▲ flashes under .

- Use < or > to set the time of day.
- Confirm with *OK*.

The time of day is now saved.

The time of day is saved for approx. 150 hours in the event of a power failure. If the power is restored within this period, the current time will be displayed again.

If the power supply is interrupted for longer, the time of day must be reset.

## Changing factory default settings

Default settings are set in the oven controls at the factory (see “Settings overview”).

A setting can be changed by altering its status.

The settings can only be changed when the mode selector is at  (Off).

- Select *OK*.
- If necessary, use < or > to move the triangle ▲ until it appears under .

## Using the oven

---



- Confirm with *OK*.

*P I* appears:

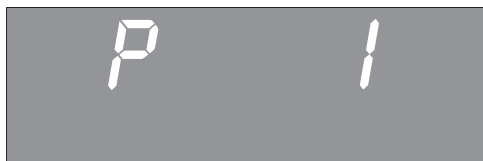

- If you want to change another setting, select the appropriate number with < or >.
- Confirm with *OK*.



The setting is selected and the current status appears, e.g., *5 0*.

To change the status:

- Set the desired status using < or >.
- Confirm with *OK*.

The status is saved and the setting appears again.

- To change additional settings, proceed in the same way.
- If you do not want to change any further settings, select '≡'.

The settings will remain in the memory in the event of a power failure.

## Settings overview

Setting	Status	
P1 Time of day display	5 0 *	The time of day display is <b>deactivated</b> . The display appears dark if the oven is switched off. The time of day continues to run in the background.  If you have selected the status 5 0, the oven has to be turned on before you can use it. The same applies if you set a timer with the <i>Timer</i> sensor button or want to use the <i>Light</i> sensor button to switch on the oven interior lighting.  The oven will also switch off automatically if you do not make any settings within a certain amount of time (approx. 30 minutes).
	5 1	The time of day display is <b>switched on</b> . The time of day is visible in the display.
P2 Audible signal volume	5 0	The audible signal is <b>turned off</b> .
	5 1 to 5 2 / *	The audible signal is <b>turned on</b> . You can adjust the volume. When you select a status you will hear the corresponding audible signal.
P3 Keypad tone	5 0	The keypad tone is <b>turned off</b> .
	5 1 *	The keypad tone is <b>turned on</b> .
P4 Time of day format	12h *	The time of day is shown in the <b>12-hour format</b> . If you change the clock after 1:00 pm from a 12-hour clock to a 24-hour clock you will need to update the hour accordingly.
	24h	The time of day is shown in the <b>24-hour format</b> .

\* Factory default

## Using the oven

Setting	Status	
<i>P 5</i> <b>Display brightness</b>	<i>5 1</i> to <i>5 7</i> , <i>5 4</i> *	Different levels of brightness can be selected for the display.  <i>5 1</i> : minimum brightness <i>5 7</i> : maximum brightness
<i>P 6</i> <b>Lighting</b>	<i>5 0</i> *  <i>5 1</i>	The oven interior lighting is <b>on for 15 seconds</b> and then turns off automatically.  The oven interior lighting is <b>permanently turned on</b> .
<i>P 7</i> <b>Temperature control</b>	<i>0</i> * <i>-3</i> to <i>3</i>	You can change the temperature in increments in all operating modes so that it is higher or lower in the oven compartment than displayed.  The higher the setting, the higher the oven temperature.
<i>P 8</i> <b>Electrical Version</b>	<i>208U</i> <i>220U</i> <i>240U</i>	You can set the voltage variant: 208 V, 60 Hz  You can set the voltage variant: 220 V, 60 Hz  You can set the voltage variant: 240 V, 60 Hz
<i>P 9</i> <b>Demo mode</b>	<i>5 0</i> *  <i>5 1</i>	Select <i>5 0</i> and press OK for approx. 4 seconds. Demo mode is <b>deactivated</b> as soon as - - - - is shown briefly in the display.  Select <i>5 1</i> and press OK for approx. 4 seconds. Demo mode is <b>activated</b> as soon as <i>NE5_</i> is shown briefly in the display.  The oven can be operated, however the heating elements will not work. Do not activate this setting for domestic use.

\* Factory default



## Switching the system lock on and off

The system lock  prevents the oven from being used unintentionally.

The appliance is delivered with the system lock deactivated. The setting for the system lock can be changed by altering its status 5:

- 5 0 = off
- 5 1 = on



The system lock status can only be changed when the mode selector is at  (Off).

### Activating the system lock

- Select *OK*.
- Move the triangle  with < or > until it appears under .



- Confirm with *OK*.

The currently set status 5 0 appears and the triangle  flashes under .



- Use < or > to set the status 5 1.



- Confirm with *OK*.



The system lock is activated.

When the appliance is switched on again, the  symbol will appear in the display to remind you that the system lock has been activated.

The system lock will remain activated even after a power failure.

### Deactivating the system lock for a cooking process

- Select an operating mode.





The  and  symbols and the current time of day will appear:





- Touch *OK* until  goes out.

The oven can now be used.

### Deactivating the system lock

- Turn the mode selector to  (Off).
- Touch *OK* until  goes out.
- Select *OK*.
- Move the triangle  with < or > until it appears under .
- Confirm with *OK*.

The currently set status 5 1 appears and the triangle  flashes under .

- Use < or > to select the status 5 0.
- Confirm with *OK*.

The system lock is deactivated.

The  symbol disappears.

### Using the timer

The timer can be used to time any activity in the kitchen, e.g. boiling eggs.

## Using the oven

The timer can also be used at the same time as a cooking program if a start and finish time have been set, e.g. a reminder to stir the dish or add seasoning.

A maximum time of 99 minutes and 55 seconds can be set for the timer.

### Setting the timer

Example: you want to boil some eggs and set a timer of 6 minutes and 20 seconds.

- Select the *Timer* sensor button.

00:00 will appear in the display with the triangle ▲ flashing under △:



- Use < or > to set the timer as desired.



- Confirm with *OK*.

The timer duration is now saved and will count down in seconds:



The △ symbol indicates that the timer has been set.

### When the timer elapses

- △ flashes.
- The time will count upwards.

- An audible signal will sound if the audible signal is turned on.

- Select the *Timer* sensor button.

The audible signal will stop and the symbols on the display will go out.

### Changing the timer

- Select the *Timer* sensor button.

The current timer appears.

- Use < or > to change the time set for the timer.
- Confirm with *OK*.

The modified timer duration is saved and will count down in seconds.

### Deleting the timer

- Select the *Timer* sensor button.
- Use < to reduce the timer time to 00:00.
- Confirm with *OK*.

The timer is deleted.

Handling and cooking food correctly is essential for maintaining good health.

Cakes, pizzas, and French fries should be cooked until golden, not dark brown.

Always observe USDA/CFIA food safety guidelines.

## Tips for baking

- Set a cooking duration. If used for baking, do not delay the start for too long. Otherwise the cake mixture or dough will dry out, and the raising agents will lose their effectiveness.
- Generally speaking, you can use wire racks, baking trays, universal trays, and any type of bakeware made of heat-resistant material.
- Avoid using bright, thin-walled pans made from a shiny material as they give an uneven or poor browning result. In certain unfavorable conditions, the food will not cook properly.
- Place cakes in rectangular bakeware on the wire rack with the longer side across the width of the oven for optimum heat distribution and even results.
- Always place bakeware on the wire rack.
- When baking cakes with fruit toppings or deep cakes, place the pan on the universal tray to catch any spillages.

## Using parchment paper

Miele accessories, e.g., the universal tray, are treated with PerfectClean (see “Features”). Surfaces treated with PerfectClean generally do not need to be greased or covered with parchment paper.

- Use parchment paper when baking lye mixtures (e.g., pretzels) because the sodium hydroxide can damage the PerfectClean treated surface.
- Use parchment paper when baking sponge cake, meringue, macarons, or similar items. These are more likely to stick due to their high egg white content.
- Use parchment paper when cooking frozen food on the wire rack.

## Selecting the temperature

- As a general rule, select the temperature given in the corresponding recipe.

Choosing a baking temperature higher than those recommended may reduce the cooking time, but will lead to uneven browning and unsatisfactory cooking results.

## Selecting the cooking duration

- Check whether the food is cooked shortly before the end of the specified cooking duration. Stick a wooden skewer into the food.

If it comes out clean without any batter/dough on it, the food is done.

# Baking

---

## Notes on the operating modes

A list of all operating modes can be found in “Overview of operating modes”.

### Using Convection (Conv Bake)

Because the blower distributes the heat around the oven compartment straight away, you can use a lower temperature than you would with the Surround  operating mode.

Use this operating mode if you are baking on multiple shelf levels at the same time.

- 1 shelf: place the food on shelf level 3.
- 2 shelves: place the food on shelf levels 1+3 or 2+4.
- 3 shelves: place the food on shelf levels 1+3+5.

### Tips

- If you are cooking on multiple shelf levels at the same time, slide the universal tray in on the lowest level.
- For moist cookies and cakes, bake on a maximum of 2 shelf levels at once.

### Using Surround

Dark metal, enamel, or aluminum bakeware with a matte finish, as well as heat-resistant glass, ceramic, and coated bakeware can be used.

Use this operating mode for cooking traditional recipes. If using an older recipe or cookbook, set the oven temperature 25°F (10°C) lower than that recommended. This will not change the cooking duration.

- Place the food on shelf level 3.



Always observe USDA/CFIA food safety guidelines.

## Tips for roasting

- You can use all dishware made from temperature-resistant materials, e.g., roasting dishes, roasting pans with lid, ovenproof glass dishes, roasting bags, dishes made from earthenware or cast iron, the universal tray, wire rack, and/or anti-splash insert (if available) on top of the universal tray.
- **Preheating** the oven is only required when preparing roast beef and fillets. Preheating is generally not necessary.
- Use a **closed cooking container** for roasting meat, such as a roasting dish. The meat will stay succulent. The oven compartment will also stay cleaner than when roasting on the wire rack. It ensures that enough stock remains for making gravy.
- If you are using a **roasting bag**, follow the instructions on the packaging.
- If you are using the **wire rack** or an **open cooking container** for roasting, you can add a little fat or oil to very lean meat or place a few strips of bacon on the top.
- **Season** the meat and place in the cooking container. Dot with butter or brush with oil or cooking fat. For large lean cuts of meat (4–6 lb/2–3 kg) and fatty poultry, add about 1/2 cup (1/8 liter) of water to the dish.
- Do not add too much liquid during cooking as this will hinder the **browning** process. Browning only occurs towards the end of the cooking duration. Remove the lid about halfway through the cooking duration if you want a more intensive browning result.

- At the end of the program, take the food out of the oven, cover it, and leave to **stand** for about 10 minutes. This helps retain the juices when the meat is sliced.
- For a crisp finish, baste **poultry** 10 minutes before the end of the cooking duration with slightly salted water.

## Selecting the temperature

- As a general rule, select the temperature given in the corresponding recipe.
- For large pieces of meat, do not choose a temperature that is too high. The roasting process will take longer, but the meat will cook through evenly and the skin or crackling will not be too thick.
- If the recipe refers to the Surround  operating mode, select a temperature that is approx. 50°F (20°C) lower when using the Convection  (Conv Bake) operating mode.
- When roasting on the Wire Rack, set a temperature approx. 25°F (10°C) lower than for roasting in a covered cooking container.

# Roasting

---

## Selecting the cooking duration

- Determine the cooking duration by multiplying the thickness of the roast [cm] with the time per cm [min/cm] stated below, depending on the type of meat:
  - beef/venison: 15–18 min/cm
  - pork/veal/lamb: 12–15 min/cm
  - sirloin/fillet: 8–10 min/cm
- Check whether the food is cooked shortly before the end of the specified cooking duration.

## Tips

- For frozen meat, increase the cooking duration by approx. 20 minutes per kg.
- Frozen meat weighing less than approx. 3.3 lb (1.5 kg) does not need to be defrosted before roasting.



## Notes on the operating modes

A list of all operating modes can be found in “Overview of operating modes”.

Use the Bake  (Bake) operating mode towards the end of the cooking duration to brown the base of the food.

## Using Convection (Conv Bake)

These operating modes are suitable for roasting meat, fish, and poultry that needs to be well browned, as well as roast beef and fillet.

The Convection  (Conv Bake) operating mode allows you to use a lower temperature than you would with the Surround  operating mode, because the heat is immediately distributed throughout the oven compartment.

- Place the food on shelf level 3.
- Place large food, e.g., a turkey, on level 1 or 2.

## Using Surround

Use this operating mode for cooking traditional recipes. If using an older recipe or cookbook, set the oven temperature 50°F (10°C) lower than that recommended. This will not change the cooking duration.

- Place the food on shelf level 3.
- Place large food, e.g., a turkey, on level 1 or 2.

 Risk of injury caused by hot surfaces.

If you broil with the door open, the hot air will escape from the oven before it has been cooled by the cooling fan. The control elements will get hot.

Broil with the oven door closed.

Always observe USDA/CFIA food safety guidelines.

## Tips for broiling

- Preheating is necessary when broiling. Preheat the browning/broiling element for approx. 5 minutes with the door closed.
- Add a little oil to lean meat if necessary. Do not use other types of fat as they can easily burn and cause smoke.
- Clean fish in the normal way. To enhance the flavor, season with a little salt. You can also drizzle the fish with lemon juice.
- Use the universal tray with the broiling and roasting insert (if present) on top and place the universal tray on the wire rack.

- The tray under the insert will collect the meat juices and stop them from burning so that they can be used for making gravy and sauces. Brush the broiling and roasting insert with oil and then place the food on top. Using the broiling and roasting insert can reduce the amount of smoke produced.

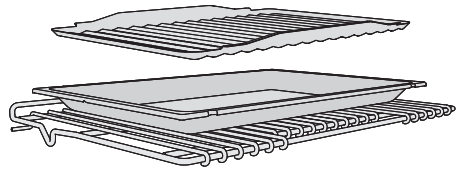

## Selecting the temperature

- As a general rule, select the temperature given in the corresponding recipe.
- For large pieces of meat, do not choose a temperature that is too high. The roasting process will take longer, but the meat will cook through evenly and the skin or crackling will not be too thick.

## Choosing a shelf level

- Select the shelf level depending on the thickness of the food to be cooked.
- Place flat food on shelf level 4 or 5.
- Place thicker food on shelf level 2 or 3.

# Broiling

---

## Selecting the cooking duration

- Broil thinner cuts of meat/slices of fish for approx. 6–8 minutes per side. It is best to broil food of a similar thickness at the same time so that the cooking durations do not vary too much.
- Check whether the food is cooked shortly before the end of the specified cooking duration.

**Tip:** If the surface of a thicker cut of meat is browned but the center is still raw, move the food to a lower level or reduce the temperature and continue broiling. This will stop the surface from becoming too dark.

## Notes on the operating modes

A list of all operating modes can be found in “Overview of operating modes”.

### Using Maxi Broil (Broil)

Use this operating mode to broil flat thin cuts in large quantities and for browning large baked dishes.

The entire browning/broiling element will become red hot to produce the necessary heat.

### Using Convection Broil (Conv Broil)

This operating mode is suitable for broiling thicker food, such as chicken.

It is generally recommended to use a temperature setting of 425°F (220°C) for thinner types of food and 350–400°F (180–200°C) for thicker cuts.



## Additional applications

This section provides information on the following applications:

- Defrost
- Dehydrating
- Warm-up Cookware
- Slow Roasting
- Canning
- Frozen food/ready meals

### Defrost

Gentle defrosting of frozen food means that the vitamins and minerals are generally retained.

- Select the Convection  (Conv Bake) operating mode without a temperature setting.

Air is circulated throughout the oven compartment to gently defrost the frozen food.

Always observe USDA/CFIA food safety guidelines.

 Risk of infection from bacteria. Bacteria such as salmonella can cause life-threatening food poisoning. It is particularly important to observe food hygiene rules when defrosting fish and meat, and in particular when defrosting poultry. Do not use the liquid produced during defrosting. Process the food as required as soon as it has been defrosted.



### Tips

- Remove the packaging and place the frozen food on the universal tray or in a suitable bowl or dish.

- Use the universal tray with the wire rack placed on top of it for defrosting poultry. This way the food will not be lying in the defrosted liquid.
- Fish does not need to be fully defrosted before cooking. Defrost until the food has started to thaw. The surface will then be sufficiently thawed to take herbs and seasoning.

### Defrosting durations

The duration needed for defrosting depends on the type and weight of the frozen food:

Frozen food	 [oz/g]	 [min]
Chicken	28/800	90–120
Meat	17.5/500	60–90
	35/1000	90–120
Sausage	17.5/500	30–50
Fish	35/1000	60–90
Strawberries	10.5/300	30–40
Pound cake	17.5/500	20–30
Bread	17.5/500	30–50

 Weight/ defrosting duration

## Additional applications

### Dehydrating

Dehydrating or drying is a traditional method of preserving fruit and certain vegetables.





It is important that fruit and vegetables are ripe and not bruised before they are dehydrated.

- Prepare the food for drying by cutting it up, and peeling and coring it if necessary.
- Distribute the food to be dried evenly according to size over the universal tray.
- Select Convection  (Conv Bake).
- Select the desired temperature.
- Place the universal tray on shelf level 3.

When using Convection  (Conv Bake) you can dehydrate on levels 2+4 at the same time.



- Turn the food to be dried halfway through the dehydrating time.

The drying times are longer for whole or halved food.

Food for drying	<input type="checkbox"/>	 [°F (°C)]	 [h]
Fruit		140-160 (60-70)	2-8
Vegetables		130-150 (55-65)	4-12
Mushrooms		115-125 (45-50)	5-10

Operating mode

Convection  (Conv Bake)

 Temperature,  drying time

- Reduce the temperature if condensation begins to form in the oven.

### Warm-up Cookware

Use the Convection  (Conv Bake) operating mode for preheating dishware.

Only preheat heat-resistant dishware.

- Place the Wire Rack on shelf level 1 and place the dishware to be preheated on it. Depending on the size of the dishware, you can also place it on the oven floor and take the side racks out to make more room.
- Select Convection  (Conv Bake).
- Set the temperature to 120–175°F (50–80°C).

 Danger of burning!

Use pot holders when removing dishware. Condensation may accumulate on the bottom of the dishware.

- Remove the heated dishware from the oven.

## Additional applications

### Slow Roasting

Slow Roasting is ideal for cooking delicate cuts of beef, pork, veal, or lamb to perfection.

Always observe USDA/CFIA food safety guidelines.

First briefly sear the meat on all sides at a high temperature on the cooktop in order to seal it.

Then place the meat in the preheated oven compartment where the low temperature and long cooking duration will cook it to perfection and ensure it is very tender.

The meat will relax. The juices inside will start to circulate evenly throughout the meat to reach the outer layers.

This gives very tender and succulent results.

- Only use lean meat which has been correctly seasoned and trimmed. Bones should be removed before cooking.
- For searing, use a suitable cooking oil or fat that can withstand high temperatures (e.g., clarified butter, vegetable oil).
- Do not cover meat during the cooking process.

The cooking duration takes approx. 2–4 hours depending on the weight and size of the meat and how well you want it cooked.

- As soon as the cooking process has finished, you can carve the meat straight from the oven. It does not need to rest.
- You can leave the meat in the oven to keep warm until you serve it. This will not affect results in any way.

- Serve on preheated plates with very hot sauce or gravy to prevent it cooling down too quickly. The meat is at an ideal temperature to eat straight away.

### Using Surround

Do not use the Booster  operating mode to pre-heat the oven.

- Use the universal tray with the broiling and roasting insert (if present) on top and place the universal tray on the wire rack.

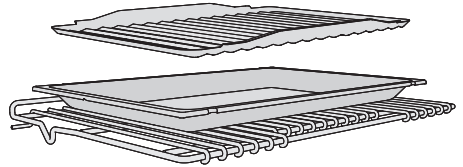

- Place the wire rack on shelf level 3.
- Select the Surround  operating mode and a temperature of 250°F (120°C).
- Preheat the oven together with the broiling and roasting insert, universal tray and wire rack for approx. 15 minutes.
- While the oven is preheating, sear the meat on all sides on the cooktop.

 Danger of burning due to hot surfaces.

The oven gets hot during operation. You could burn yourself on the heater elements, oven compartment, or accessories.

Use pot holders when placing food in the appliance or removing it and when working in the hot oven compartment.

- Place the seared meat on the broiling and roasting insert.
- Reduce the temperature to 210°F (100°C).
- Continue cooking the meat until it is done.

# Additional applications

## Cooking durations/core temperatures

Always observe USDA/CFIA food safety guidelines.

Meat	Cooking duration	Core temperature
Beef tenderloin, approx. 2.2 lbs (1 kg) - rare - medium - well done	60–80 min 75–85 min 110–130 min	113–119°F (45–48°C) 129–135°F (54–57°C) 145–151°F (63–66°C)
Prime rib, approx. 2.2 lbs (1 kg) - rare - medium - well done	70–80 min 105–115 min 130–140 min	113–119°F (45–48°C) 129–135°F (54–57°C) 145–151°F (63–66°C)
Pork tenderloin, approx. 0.75 lbs (350 g)	70–90 min	145–156°F (63–69°C)
Gammon joint*, approx. 2.2 lbs (1 kg)	140–160 min	145–151°F (63–66°C)
Veal tenderloin, approx. 2.2 lbs (1 kg) - pink - medium - well done	45–55 min 75–85 min 90–100 min	113–119°F (45–48°C) 129–135°F (54–57°C) 145–151°F (63–66°C)
Saddle of veal*, approx. 2.2 lbs (1 kg) - pink - medium - well done	75–85 min 100–130 min 130–140 min	113–119°F (45–48°C) 129–135°F (54–57°C) 145–151°F (63–66°C)
Saddle of lamb*	40–60 min	129–151°F (54–66°C)

\* Boneless

### Canning

 Risk of infection from bacteria.

The spores of the botulinum bacterium are not sufficiently killed by canning legumes and meat only once. Toxins may form which can lead to serious poisoning. These spores are only destroyed by canning the food again.

After they have cooled down, **always** reheat legumes and meat a second time within 2 days.

 Risk of injury from increased pressure in sealed cans.

Canning food and heating it up in closed containers results in an increase in pressure which can cause them to explode.

Do not use cans for canning or reheating food.

Always observe USDA/CFIA food safety guidelines.

### Preparing fruit and vegetables

The instructions are for 6 jars with a capacity of 1 L each.

Only use jars that are specifically designed for canning (preserving jars or jars with a screw cap). Only use undamaged jars and rubber rings.

- Rinse the jars with hot water before canning and fill them up to a maximum of 3/4" (2 cm) below the rim.
- After filling the jars, clean the outside of the rims with a clean cloth and hot water, and then seal the jars.
- Slide the universal tray onto shelf level 3. Place the jars on the tray.
- Select the Convection  (Conv Bake) operating mode and a temperature of 320–340°F (160–170°C).
- Wait until bubbles rise evenly in the jars.

Then reduce the temperature to prevent the contents from boiling over.



# Additional applications

## Canning fruit and vegetables

- Set the specified post-canning warming temperature as soon as bubbles are visible in the jars, then leave the jars in the warm oven for the time specified.

## Canning vegetables

- As soon as bubbles are visible in the jars, set the specified canning temperature and cook the vegetables for the time specified.
- After canning, set the specified post-canning warming temperature, then leave the jars in the warm oven for the time specified.

		
Fruit	-/-	85°F (30°C) 25–35 min
Pickling cucumbers	-/-	85°F (30°C) 25–30 min
Red beets	250°F (120°C) 30–40 min	85°F (30°C) 25–30 min
Beans (green or yellow)	250°F (120°C) 90–120 min	85°F (30°C) 25–30 min

 Canning temperature and time once bubbles are visible in the jars

 Post-canning warming temperature and time

## Removing the jars after canning

 Risk of injury caused by hot surfaces.

The jars will be very hot after canning. Use oven mitts when removing the jars from the oven.

- Take the jars out of the oven.
- Cover the jars with a towel and leave to set for approx. 24 hours in a draft-free area.
- After they have cooled down, **always** reheat beans and meat a second time within 2 days.
- Remove the fasteners from the jars and make sure all jars are closed properly when storing them.

Either boil open jars again or store them in a cool place and consume the preserved fruit or vegetables immediately.

- Check the jars during storage. If jars have opened during storage or if the screw cap is bulging and does not make a popping noise when opened, dispose of the contents.

### Frozen food/ready meals

#### Tips for cakes, pizza, and baguettes

- Bake cakes, pizza, and baguettes on parchment paper on the wire rack.
- Use the lowest temperature recommended by the manufacturer.

#### Tips for French fries, croquettes, and similar items

Use the AirFry  operating mode to cook these frozen foods (see “AirFry”).

### Preparing frozen food/ready meals

Handling and cooking food correctly is essential for maintaining good health.

Cakes, pizzas, and French fries should be cooked until golden, not dark brown.

- Select the operating mode and temperatures recommended on the food’s packaging.
- Preheat the oven.
- Place the food in the preheated oven on the shelf level recommended on the packaging.
- Check the food at the end of the shortest time recommended on the packaging.

# Cleaning and care of the induction cooktop

 Risk of injury due to hot cooking zones.

The cooking zones will be hot after use.

Turn off the cooktop.

Allow the cooking zones to cool down before cleaning the cooktop.

 Risk of injury due to electric shock.

The steam from a steam cleaner could reach live electrical components and cause a short circuit.

Never use a steam cleaner for cleaning.

All surfaces could become discolored or damaged if unsuitable cleaning agents are used. All surfaces are susceptible to scratching.

Remove any residual cleaning agent immediately.

Do not clean with any abrasive cleaning agents or sharp pointed objects.

- Clean the cooktop after every use.
- Dry the cooktop thoroughly after every cleaning to avoid limescale residue.

## Unsuitable cleaning agents

To avoid damaging the surfaces of your appliance, do not use:

- liquid dish soap
- cleaning agents containing soda, ammonia, acids, or chlorides
- cleaning agents containing descaling agents
- stain or rust removers

- abrasive cleaning agents (e.g., powder cleaners and cream cleaners)
- solvent-based cleaning agents
- dishwasher cleaning agents
- grill and oven sprays
- glass cleaners
- hard, abrasive brushes or sponges (e.g., pot scourers, brushes, or sponges which have been previously used with abrasive cleaning agents)
- eraser sponges

## Cleaning the glass-ceramic surface

 Risk of damage caused by pointed objects.

The seal between the cooktop and the countertop could be damaged. The seal between the glass-ceramic surface and the frame could be damaged.

Do not use pointed objects for cleaning.

When cleaning with liquid dish soap, not all contaminants and residues are removed. An invisible film forms, which causes discoloration of the glass-ceramic surface. This discoloration cannot be removed. Clean the glass-ceramic surface regularly with a suitable cleaning agent for ceramic cooktops.

- First wipe down the surface with a damp cloth to loosen soiling, then remove stubborn crusting with a glass scraper.
- Then clean the glass-ceramic surface with the Miele ceramic and stainless steel cleaner (see “Features”) or with a commercially available ceramic



# Cleaning and care of the induction cooktop

glass cleaner applied with paper towels or a clean cloth. Do not put the cleaner on a hot glass-ceramic surface since this may cause staining. Please follow the cleaning agent manufacturer's instructions.

- Remove any cleaner residue with a damp cloth and then dry the glass-ceramic surface.

Residues can burn onto the cooktop the next time it is used and cause damage to the glass-ceramic surface. Ensure that all cleaning agent residues are removed.

- **Stains** caused by limescale, water, and aluminum residues (stains with a metallic appearance) can be removed using the Miele ceramic and stainless steel cleaner.



Risk of burning due to hot cooking zones.

The cooking zones are hot during use. Wear pot holders when removing sugar, plastic, or aluminum foil residues from the hot glass-ceramic surface using a glass scraper.

- Should any **sugar, plastic, or aluminum foil** spill or fall onto the hot glass-ceramic surface while it is in use, turn off the cooktop.
- Then carefully scrape off these residues **immediately** while they are still hot, using a glass scraper.
- Allow the glass-ceramic surface to cool down and then clean as described above.

## Cleaning the cooking zone knobs

- Clean the knobs with a soft sponge, warm water, and a small amount of liquid dish soap.

## Cleaning and care of the oven

---

 Risk of injury caused by hot surfaces.

The oven gets hot during operation. You could burn yourself on the heating elements, oven compartment, or accessories. Allow the heating elements, oven compartment, and accessories to cool before manual cleaning.

 Risk of injury due to electric shock.

The steam from a steam cleaning appliance could reach live electrical components and cause a short circuit. Never use a steam cleaner for cleaning.

All surfaces could be discolored or damaged if unsuitable cleaning agents are used. The oven front is particularly susceptible to damage from oven cleaners or descaling agents.

All surfaces are susceptible to scratching. Scratches on glass can lead to breakage in some circumstances.

Remove all cleaning agent residues immediately.

### Unsuitable cleaning agents

To avoid damaging the surfaces of your appliance, do not use the following cleaning agents:

- cleaning agents containing soda, ammonia, acids, or chlorides
- cleaning agents containing descaling agents on the front
- abrasive cleaning agents (e.g., powder cleaners and cream cleaners)
- solvent-based cleaning agents
- stainless steel cleaners
- dishwasher cleaning agents
- glass cleaners
- cleaning agents for glass-ceramic cooktops
- hard, abrasive brushes or sponges (e.g., pot scourers, brushes, or sponges which have been previously used with abrasive cleaning agents)
- eraser sponges
- sharp metal scrapers
- steel wool
- spot cleaning with mechanical cleaning agents
- oven cleaners
- stainless-steel spiral pads

If soiling is allowed to sit for any length of time, it may become impossible to remove. If the appliance is used frequently without being cleaned, it may become very difficult to clean.

It is therefore best to remove any soiling immediately.

The accessories are not dishwasher-safe.

# Cleaning and care of the oven

**Tip:** Soiling caused by spilled fruit juices and cake mixtures is best removed while the oven is still warm. Use caution and make sure the oven is not too hot.

To make it easier to clean the oven:

- Remove the door.
- Remove the side racks.

## Removing normal soiling

There is a fiberglass seal around the oven compartment which seals the inside of the glass oven door and can be damaged by rubbing and scouring. Avoid cleaning the fiberglass seal. The fiberglass seal is essential for sealing the door properly.

## Removing normal soiling

- Remove normal soiling immediately with warm water, liquid dish soap, and a clean sponge or a clean, damp microfiber cloth.
- Remove all cleaning agent residues thoroughly with clean water. This is particularly important for any parts with a PerfectClean finish, as cleaning agent residues will impair the non-stick function.
- After cleaning, wipe the surfaces dry using a soft cloth.

## Removing stubborn soiling

Do not line the oven (e.g., with aluminum foil) and do not use standard oven cleaners unless they are suitable for use in a self-cleaning oven.

Spilt fruit and roasting juices may cause lasting discoloration or matte patches on surfaces. This discoloration will not affect the properties of the surface finish.

Do not attempt to remove these marks. Clean them following the instructions given here.

- Baked-on deposits can be removed with a glass scraper or with a stainless-steel spiral pad, hot water, and liquid dish soap.

You do not need to treat the oven compartment with an oven cleaner as the oven comes with  Self Clean.

- If necessary, you can use the scouring pad on the back of a non-scratching dish sponge to remove the soiling after the holding time.
- Remove all cleaning agent residues thoroughly with clean water.
- Dry all surfaces with a soft cloth.

# Cleaning and care of the oven

## Cleaning the oven compartment with Self clean (Clean)

Instead of cleaning the oven manually you can use the Self clean  (Clean) operating mode.

During the Self Clean function, the oven compartment reaches temperatures in excess of 750°F (400°C). Any grime that has accumulated will be broken down and burnt to ash as a result of the high temperatures.

There are 3 Self Clean settings available, each with a different duration:

- level 1 for light soiling
- level 2 for heavier soiling
- level 3 for very heavy soiling

The oven door is automatically locked when the Self Clean process starts. It cannot be opened until after the program has finished.

The timer can be used to delay the start time of the Self Clean program.

At the end of the Self Clean program, any residues such as ash from the cleaning process, which are formed depending on the oven compartment's degree of soiling, can be easily wiped away.

### Preparing for Self Clean

Accessories that are not suitable for the Self Clean program will be damaged by the high temperatures. Remove all accessories that are not suitable for the Self Clean program from the oven compartment before starting the Self Clean process. This also applies for optional accessories that are not suitable for the Self Clean program.

The following accessories are suitable for the Self Clean program and can be left in the oven compartment during the process:

- Side runners
  - FlexiClips with Wire Rack HFCBBR 30-3
  - Wire rack HBBR 30-2
- Remove all accessories that are not suitable for the Self Clean program from the oven.
  - Slide the wire rack into the top shelf level.

Coarse soiling in the oven compartment can cause thick smoke to develop.

Burnt-on residues can cause lasting discoloration or matte spots on enameled surfaces.

Before starting the Self Clean program, remove coarse soiling from the oven compartment and scrape any burnt-on residues off enameled surfaces with a glass scraper.

### Starting Self Clean

 Risk of injury caused by hazardous steam.

During the Self Clean program, steam can be released.

During the Self Clean program, do not stay in the kitchen for longer periods of time and do not let children and pets enter the kitchen.

It is important to ensure that the kitchen is well ventilated during the Self Clean program. Close doors to other rooms to prevent the odor spreading throughout the house.

# Cleaning and care of the oven

## ⚠ Risk of burns!

The front of the oven gets hotter in the Self Clean program than it does in normal oven modes.

Do not let children touch the appliance during the Self Clean program.

- Select the Self clean  (Clean) operating mode.



*PY 1* appears. The number will flash.



Use < or > to choose between the *PY 1*, *PY 2*, and *PY 3* Self Clean levels.

- Select the desired Self Clean level.
- Confirm with *OK*.

The Self Clean program will start.

 will also appear in the display.





While  is flashing, the door is locked automatically.  lights up as long as it is locked.

The oven heating and the cooling fan will then turn on automatically.

The oven interior lighting will not come on during the Self Clean program.

If you want to see how the Self Clean program is progressing, you need to highlight the duration symbol  in the display.

- Select *OK*.



- If necessary, use < or > to move the triangle  until it appears under .

The remaining duration for the Self Clean program will start counting down on the display. You cannot alter the duration.

You can use the timer while the Self Clean program is running. When the set time has elapsed, the audible signal will sound and  will flash. The time will then continue to increase on the display. The audible signal will stop and the symbols in the display will go out as soon as you confirm with *OK*. *PY* and the number of the selected Self Clean program will appear again.

## Starting Self Clean at a later time

Start the Self Clean program as described above and then set the required finish time within the first five minutes of starting the program.

- Select *OK*.
- Move the triangle  with < or > until it appears under .

--:-- appears.

- Confirm with *OK*.

The display will show the finish time calculated from the current time of day plus the duration of the selected Self Clean program.

- Set the desired finish time using < or >.
- Confirm with *OK*.

The finish time is now saved.

The oven heating switches off.



The finish time can be changed at any time up until the start time for the program.



## Cleaning and care of the oven

As soon as the start time is reached, the oven heating and the cooling fan will switch on. The duration will appear in the display.



### At the end of the Self Clean program



0:00, , and  will appear in the display.

As long as  lights up, the door is locked. When  flashes, the door is unlocked.

When the door lock has been deactivated:

-  goes out.
-  flashes.
- Short signals will sound if the audible signal is switched on.

- Turn the mode selector to  (Off).

The audible signal will stop and the symbols on the display will go out.

 Danger of injury caused by hot surfaces.

At the end of the Self Clean program, the oven will still be very hot. You could burn yourself on the heater elements and the oven compartment.

Allow the heating elements and the oven compartment temperature to drop to a safe level before removing any residues.

- Clean the oven compartment to remove any Self Clean residues (e.g., ash) that can build up depending on the degree of soiling in the oven compartment.



Most residues can be removed with warm water, liquid dish soap, and a clean sponge or a clean, damp microfiber cloth.

Depending on how dirty the oven was prior to cleaning, there may be a visible layer of soiling across the inner glass pane on the door. You can remove this using the scouring side of a dish sponge, a glass scraper, or with a stainless steel spiral pad and liquid dish soap.

### Please note:

- There is a fiberglass seal around the oven compartment which seals the inside of the glass oven door and can be damaged by rubbing and scouring. Do not clean the door seal – it is essential for sealing the door properly.
- Spilled fruit juices may cause lasting discoloration of enameled surfaces. This discoloration is permanent but will not affect the properties of the enamel. Do not attempt to remove these stains.

## Self Clean interrupted



If the Self Clean program is canceled, the oven door will remain locked until the temperature inside the oven drops to below 535°F (280°C).  remains lit up until the temperature of the oven compartment has fallen below this temperature. When  flashes, the door is unlocked.

The following events will cause the Self Clean program to stop:



- The mode selector is turned to  (Off).

Once the door has been unlocked,  will go out and the time of day will appear. Start the Self Clean program again if necessary.

- The mode selector is turned to a different operating mode.

*Py* and  appear. Once the door has been unlocked,  will go out and *Py* will flash. Start the Self Clean program again if necessary.

- A power failure occurs.

*Py* and  appear. Once the door has been unlocked,  will go out and *Py* will flash.

When power is restored, *Py* remains lit up until the temperature of the oven compartment has fallen below 535°F (280°C).  will then appear. The door is unlocked and the time of day will appear.

# Cleaning and care of the oven

## Removing the door

The door weighs approx. 39.7 lbs (19 kg).

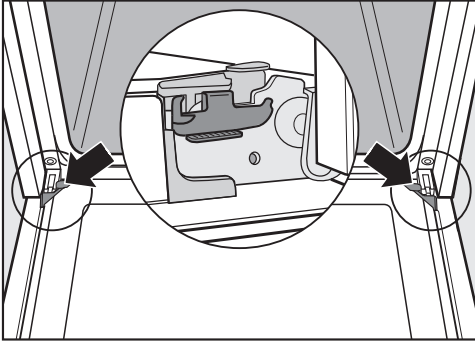

The oven door is connected to the hinges by retainers. Before removing the door from the retainers, the locking clamps on both hinges have to be released.

- Open the door fully.

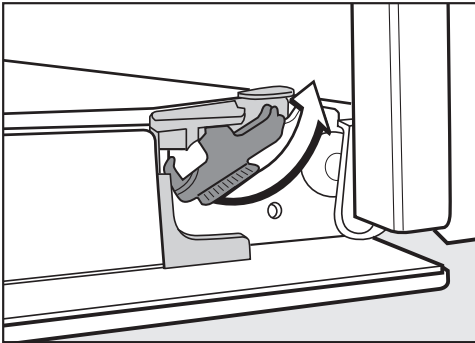

- Release the locking clamps by turning them as far as they will go.

- Raise the door up till it rests partially open.



- Hold the door on either side and pull it upwards off the hinge retainers. Make sure that the door is straight.

You could damage the oven if you remove the door incorrectly.

Do not pull the door horizontally off its retainers, as they will spring back against the oven.

Do not pull the door off the retainers by the handle, as the handle could break off.



## Installing the door

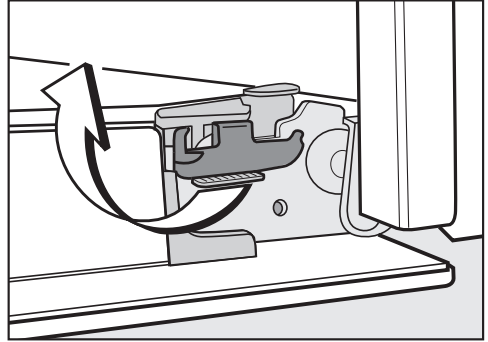
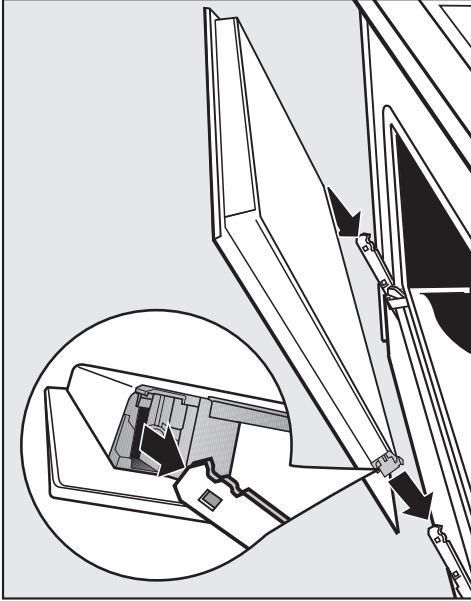

- To relock the locking clamps, turn them back up to the horizontal position as far as they will go.

- Hold the door securely on both sides and carefully install it back into the hinge retainers. Make sure that you do not tilt the door.
- Open the door fully.

If the locking clamps are not locked, the door could become loose, resulting in damage. Ensure that the locking clamps are locked after reinstalling the door.

# Cleaning and care of the oven

---

## Side rack removal

 Danger of injury caused by hot surfaces.

The oven gets hot during operation. You could burn yourself on the heater elements, oven compartment, or accessories.

Allow the heating elements, oven compartment, and accessories to cool before removing the side racks.

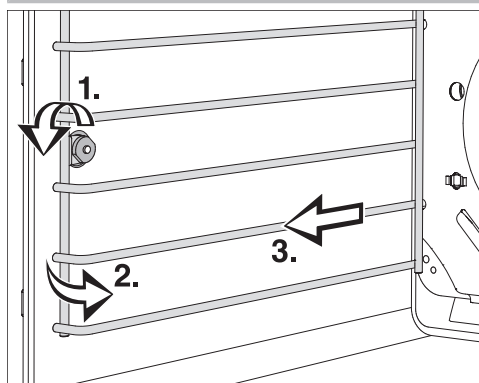

- Loosen the knurled screw (1.).
- Pull the side racks forwards out of the holder (2.).
- Remove the side racks (3.).

**Reinstall** by following these instructions in reverse order.

- Insert the components carefully.

## Frequently asked questions

Many malfunctions and faults that can occur in daily operation can be easily remedied. You can save time and money in many cases, as you do not need to contact Miele Customer Service.

Information to help you rectify faults yourself can be found at [www.miele.com/service](http://www.miele.com/service).

The following tables are designed to help you to find the cause of a malfunction or a fault and to resolve it.

Problem	Possible cause and solution
<p><b>The cooktop or cooking zones cannot be turned on.</b></p>	<p>There is no power to the range.</p> <ul style="list-style-type: none"> <li>■ Check if the breaker has tripped. Contact a qualified electrician or Miele Service (for the minimum fuse rating, see data plate).</li> </ul> <p>There may be a technical fault.</p> <ul style="list-style-type: none"> <li>■ Disconnect the range from the power supply for approx. 1 minute:               <ul style="list-style-type: none"> <li>– Turn off the relevant breaker.</li> <li>– Remove the screw-in fuse completely.</li> <li>– Turn off the ground fault circuit interrupter (GFCI).</li> </ul> </li> <li>■ If, after resetting/replacing the breaker or the GFCI, it still will not turn on, contact a qualified electrician or Miele Service.</li> </ul>
<p><b>There is a strange smell or vapors when the cooktop is being used for the first time.</b></p>	<p>The metal components have a protective coating. When the cooktop is used for the first time, this causes a smell and possibly also vapor. The material from which the induction coils are made also gives off a smell in the first few hours of operation. With each subsequent use, the odors are reduced until they disappear completely. The smell and any vapors do not indicate a faulty connection or a defective appliance and are not harmful to your health.</p>
<p><b>On the cooking zone indicator, the <math>\underline{L}</math> symbol flashes alternately with the selected power level or <math>\bar{R}</math>.</b></p>	<p>No cookware or unsuitable cookware has been placed on the cooking zone.</p> <ul style="list-style-type: none"> <li>■ Use suitable cookware (see “Operating the induction cooktop – How induction works”).</li> </ul>
<p><b>After the cooktop is turned on, <math>LC</math> appears in the display for a few seconds.</b></p>	<p>The system lock is activated.</p> <ul style="list-style-type: none"> <li>■ Deactivate the system lock (see “Features – Safety features of the induction cooktop”).</li> </ul>

## Frequently asked questions

Problem	Possible cause and solution
<p>After the cooktop is turned on, <i>dE</i> appears on the display for a few seconds. The cooking zones do not heat up.</p>	<p>Demo mode is activated (see “Features – Safety features of the induction cooktop”).</p> <ul style="list-style-type: none"> <li>■ Turn and hold the knob for the front left cooking zone counterclockwise.</li> <li>■ While holding the (front left) cooking zone knob, turn the knob for the front right cooking zone briefly counterclockwise twice and then hold it counterclockwise until <i>0000</i> appears on the display.</li> </ul>
<p>A cooking zone turns itself off automatically.</p>	<p>The operating time was too long; the safety shut-off was triggered automatically.</p> <ul style="list-style-type: none"> <li>■ Turn the cooking zone back on (see “Features – Safety features of the induction cooktop”).</li> </ul>
<p>The Booster has automatically turned off early.</p>	<p>Overheating protection has been triggered.</p> <ul style="list-style-type: none"> <li>■ See “Features – Safety features of the induction cooktop” for more information.</li> </ul>
<p>The cooking zone is not working in the usual way with the set power level.</p>	<p>Overheating protection has been triggered.</p> <ul style="list-style-type: none"> <li>■ See “Features – Safety features of the induction cooktop” for more information.</li> </ul>
<p>Power level 9 is automatically reduced if you also set power level 9 for the connected cooking zone.</p>	<p>Operating both zones at power level 9 would exceed the permitted maximum power for the cooktop.</p> <ul style="list-style-type: none"> <li>■ Use a different cooking zone.</li> </ul>
<p>Auto Heat-up is turned on, but the food does not start cooking.</p>	<p>Large amounts of food are being heated.</p> <ul style="list-style-type: none"> <li>■ Start cooking at the highest power level, then reduce the power level manually.</li> </ul>
	<p>The pan is not conducting heat properly.</p> <ul style="list-style-type: none"> <li>■ Use a different pan that is able to better conduct heat on an induction cooktop.</li> </ul>
<p>A noise can be heard after the appliance is turned off.</p>	<p>The fan will continue running until the cooktop has cooled down. It will then turn itself off automatically.</p>
<p><i>F</i> is flashing on the indicator of one or more cooking zones.</p>	<p>The cooking zone knob has been turned clockwise or counterclockwise for more than 30 seconds.</p> <ul style="list-style-type: none"> <li>■ Turn the cooking zone knob to <i>0</i>. If the fault message does not go out, there is a technical fault. Contact Miele Service.</li> </ul>

## Frequently asked questions

Problem	Possible cause and solution
<p>The cooking zone knob is not at 0; a power level is set for the cooking zone. The cooking zone is not heating up. 0 lights up or flashes alternately with 1 on the cooking zone indicator.</p>	<p>There was a power outage during operation.            The cooking zone has been turned on for more than 3 minutes without suitable cookware on it.            The maximum operating time for the cooking zone has been exceeded.</p> <ul style="list-style-type: none"> <li>■ Turn the cooking zone knob to 0.</li> </ul> <p>The cooking zone can be started up again.</p>
<p>FE flashes alternately with numbers on the indicator for a cooking zone.</p>	<p>There is an electronic fault.</p> <ul style="list-style-type: none"> <li>■ Disconnect the power supply to the cooktop for approx. 1 minute. If the problem persists after reconnecting the power supply, contact Miele Service.</li> </ul>
<p>The display is dark.</p>	<p>There is no power to the oven.</p> <ul style="list-style-type: none"> <li>■ Check that the oven's electrical plug is correctly inserted in the socket and that the circuit breaker has been switched to on.</li> <li>■ Check if the breaker has tripped. If it has, contact a qualified electrician or Miele Customer Service.</li> </ul>
<p>The oven does not heat up.</p>	<p>You have only selected an operating mode or a temperature.</p> <ul style="list-style-type: none"> <li>■ Select both a mode <b>and</b> a temperature.</li> </ul>
	<p>The system lock  is activated.</p> <ul style="list-style-type: none"> <li>■ Switch the system lock off (see "Using the oven – Operating the clock/timer").</li> </ul>
	<p>There is no power to the oven.</p> <ul style="list-style-type: none"> <li>■ Check if the breaker has tripped. If it has, contact a qualified electrician or Miele Customer Service.</li> </ul>
	<p>Demo mode is activated. <i>DEMO</i> appears.</p> <p>The oven can be operated, however the heating elements will not work.</p> <ul style="list-style-type: none"> <li>■ Deactivate demo mode (see "Using the oven – Operating the clock/timer").</li> </ul>
<p>12:00 is flashing in the display.</p>	<p>There has been a power failure.</p> <ul style="list-style-type: none"> <li>■ Reset the time of day (see "Before using for the first time").</li> </ul> <p>Cooking times will also need to be reset.</p>

## Frequently asked questions

Problem	Possible cause and solution
<p><b>0:00</b> appears unexpectedly in the display and  is flashing at the same time. The audible signal might also be sounding.</p>	<p>The oven has been operating for an unusually long period of time, and this has activated the safety shut-off.</p> <ul style="list-style-type: none"> <li>■ Turn the mode selector to <input type="checkbox"/> (Off). The oven is ready for use again immediately.</li> </ul>
<p><b>F 32</b> appears on the display.</p>	<p>The door lock for the Self Clean program has not locked.</p> <ul style="list-style-type: none"> <li>■ Turn the mode selector to <input type="checkbox"/> (Off) and select the Self Clean program again. If the problem persists, contact Miele Customer Service.</li> </ul>
<p><b>F 33</b> appears on the display.</p>	<p>The door lock for the Self Clean program has not opened.</p> <ul style="list-style-type: none"> <li>■ Turn the mode selector to <input type="checkbox"/> (Off) and switch the oven off. If the problem persists, contact Miele Customer Service.</li> </ul>
<p><b>F</b> and a fault code not listed here appear on the display.</p>	<p>A fault has occurred that you cannot resolve.</p> <ul style="list-style-type: none"> <li>■ Contact Miele Customer Service.</li> </ul>
<p><b>A noise is heard after the cooking process is complete.</b></p>	<p>After the cooking process the cooling fan will continue to run for a while after a program is complete to prevent moisture from building up in the oven, on the control panel or surrounding cabinetry. The cooling fan will turn off automatically.</p>
<p><b>The oven has turned itself off.</b></p>	<p>To save power, the oven turns off automatically if a button is not pressed after a certain amount of time or after a cooking program has ended.</p> <ul style="list-style-type: none"> <li>■ Turn the oven back on.</li> </ul>
<p><b>The cake/cookies are not baked properly.</b></p>	<p>A different temperature than that given in the recipe was used.</p> <ul style="list-style-type: none"> <li>■ Select the temperature required for the recipe.</li> </ul>
	<p>The ingredient quantities are different from those given in the recipe.</p> <ul style="list-style-type: none"> <li>■ Check if you have amended the recipe. The addition of more liquid or more eggs will make a wetter mixture which will take longer to cook.</li> </ul>

## Frequently asked questions

Problem	Possible cause and solution
<p><b>The browning of cakes/cookies is uneven.</b></p>	<p>The wrong temperature or shelf level was selected.</p> <ul style="list-style-type: none"> <li>■ There will always be a slight unevenness. If browning is very uneven, check whether you selected the correct temperature and shelf level.</li> </ul> <p>The material or color of the bakeware is not suitable for the operating mode selected.</p> <ul style="list-style-type: none"> <li>■ When using the Surround  operating mode, light-colored, shiny baking pans will not produce as desirable results. Dark, matte baking pans are best for baking.</li> </ul>
<p><b>There is still soiling in the oven compartment after a Self Clean program.</b></p>	<p>The Self Clean program burns off soiling in the oven and leaves it as ash.</p> <ul style="list-style-type: none"> <li>■ Remove the ash with warm water, liquid dish soap, and a clean sponge or a clean, damp microfiber cloth. If there is still coarse soiling left in the oven after the Self Clean program, you should start the program again, selecting a longer duration if necessary.</li> </ul>
<p><b>The accessories make noises when they are pushed into or pulled out of the oven.</b></p>	<p>The Self-Clean-resistant surface of the side runners creates friction when accessories are pushed into or pulled out of the oven.</p> <ul style="list-style-type: none"> <li>■ To reduce the friction, add a few drops of heat-resistant cooking oil to some kitchen paper and use this to lubricate the side runners. Repeat this after every Self Clean program.</li> </ul>
<p><b>The oven interior lighting turns off after a short time.</b></p>	<p>The oven lighting is set to switch off after 15 seconds (default setting). You can change this setting (see “Using the oven – Operating the clock/timer”).</p>

## Frequently asked questions

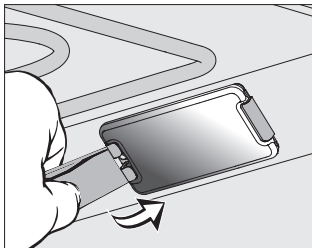
Problem	Possible cause and solution
<p data-bbox="73 201 387 256"><b>The oven interior lighting does not turn on.</b></p> 	<p data-bbox="398 201 714 228">The halogen lamp is faulty.</p> <div data-bbox="404 236 1039 451" style="border: 1px solid gray; padding: 5px;"><p data-bbox="415 244 941 280">⚠ Danger of injury caused by hot surfaces. The oven gets hot during operation. You could burn yourself on the heater elements, oven compartment, or accessories. Allow the heater elements, oven compartment, and accessories to cool before manual cleaning.</p></div> <div data-bbox="404 467 1039 611" style="border: 1px solid gray; padding: 5px;"><p data-bbox="415 475 986 600">The lamp cover may be damaged if it falls down. Hold onto the lamp cover while removing it so it does not fall down. Place a cloth over the oven floor to protect it and the open door.</p></div> <ul data-bbox="398 632 1039 1007" style="list-style-type: none"><li data-bbox="398 632 1039 691">■ Disconnect the oven from the electrical supply. Unplug the appliance or switch off the breaker.</li><li data-bbox="398 695 1039 754">■ Remove the lamp cover from the frame from behind with the tool supplied.</li><li data-bbox="398 759 1039 879">■ Do not grasp the halogen lamp with your bare fingers. Please follow the manufacturer's instructions. Remove the halogen lamp.</li><li data-bbox="398 884 1039 943">■ Replace the halogen lamp (Osram 66725 AM/A, 230 V, 25 W, G9).</li><li data-bbox="398 948 1039 975">■ Press the lamp cover back into place.</li><li data-bbox="398 979 1039 1007">■ Reconnect the oven to the electrical supply.</li></ul>



Information to help you rectify faults yourself and about Miele spare parts can be found at [www.miele.com/service](http://www.miele.com/service).

### Contact in the event of a fault

In the event of a fault which you cannot remedy yourself, please contact your Miele dealer or Miele Customer Service.

You can book a Miele Service Call online at [www.miele.com/service](http://www.miele.com/service).

Contact information for Miele Customer Service can be found at the end of this document.

Please quote the model identifier and serial number of your appliance (SN) when contacting Miele Customer Service. Both pieces of information can be found on the data plate.

This information is given on the data plate, visible on the front frame of the oven, with the door fully open.

### Appliance warranty and product registration

You can register your product and/or view the manufacturer's warranty terms and conditions for Miele appliances and vacuum cleaners at [www.mieleusa.com](http://www.mieleusa.com).

# Caring for the environment

---

## Disposal of the packing material

The cardboard box and packing materials protect the appliance during shipping. They have been designed to be biodegradable and recyclable.

Ensure that any plastic wrappings, bags, etc. are disposed of safely and kept out of the reach of children. Danger of suffocation!

## Disposal of your old appliance

Electrical and electronic appliances contain valuable materials. They also contain certain substances, compounds and components which were essential for the proper functioning and safe use of the equipment. Handling these materials improperly by disposing of them in your household waste can be harmful to your health and the environment. Therefore, please do not dispose of your old appliance with regular household waste and follow local regulations on proper disposal.



Consult with local authorities, dealers or Miele in order to dispose of and recycle electrical and electronic appliances. Miele assumes no responsibility for deleting any personal data left on the appliance being disposed. Please ensure that your old appliance is kept away from children until removal. Observe safety requirements for appliances that may tip over or pose an entrapment hazard.

Please have the model and serial number of your appliance available when contacting Customer Service.

---

## **U.S.A.**

**Miele, Inc.**

### **National Headquarters**

9 Independence Way  
Princeton, NJ 08540  
[www.mieleusa.com](http://www.mieleusa.com)

### **Customer Support**

Phone: 888-99-MIELE (64353)  
[info@mieleusa.com](mailto:info@mieleusa.com)

### **International Headquarters**

Miele & Cie. KG  
Carl-Miele-Straße 29  
33332 Gütersloh  
Germany

## **Canada**

**Importer  
Miele Limited**

### **Headquarters and Miele Centre**

161 Four Valley Drive  
Vaughan, ON L4K 4V8  
[www.miele.ca](http://www.miele.ca)

### **Customer Care Centre**

Phone: 1-800-565-6435  
905-532-2272  
[customercare@miele.ca](mailto:customercare@miele.ca)

HR 1422-3 i

en-US, CA

M.-Nr. 12 449 750 / 04