

# Operating instructions Washer-disinfector

## **CompactLine** PWD 8682 C

---

**Always** read the operating instructions before setting up, installing and commissioning the machine. This prevents both personal injury and damage to the machine.



en-GB



<b>Notes about these instructions</b> .....	<b>7</b>
Applicable symbols .....	7
Symbols and conventions used in this document.....	8
Definition of terms .....	8
<b>Guide to the appliance</b> .....	<b>9</b>
Machine overview .....	9
Control panel.....	10
Sensor controls on the control panel .....	11
<b>Intended use</b> .....	<b>12</b>
General description.....	12
How it works .....	12
Medical use.....	12
Purpose.....	12
Intended user group.....	12
Application restriction .....	13
Foreseeable misuse .....	13
<b>User profiles</b> .....	<b>14</b>
Daily operators.....	14
Administration .....	14
<b>Safety instructions and warnings</b> .....	<b>15</b>
Symbols on the machine.....	19
<b>Operation</b> .....	<b>20</b>
Operation via control panel.....	20
Display screens.....	20
Switching on.....	21
Switching off .....	22
Standby/Off.....	22
Touch display.....	22
Selecting the language .....	24
System messages <b>i</b> .....	25
Fault messages <b>!</b> .....	25
Help button .....	25
Networking (☎ or L).....	26
<b>Opening and closing the door</b> .....	<b>27</b>
Comfort door lock .....	27
Opening the door.....	27
Closing the door.....	27
Opening the door using the emergency release .....	28
<b>Water hardness</b> .....	<b>30</b>
Water softening .....	30
Setting the water hardness.....	30
Reactivation salt .....	33
Filling the container for reactivation salt .....	33
Salt refill indicator.....	34
Cancelling machine lock due to lack of salt.....	36
<b>Load carriers</b> .....	<b>37</b>
Baskets, modules and inserts .....	37
Wash pressure measurement .....	38

# Contents

---

<b>Areas of application</b> .....	<b>39</b>
Preparing the load items .....	39
Preparing the load items .....	40
Checks before starting a programme .....	41
After reprocessing .....	42
Recontamination.....	42
Protein test .....	42
Dental medicine.....	43
Saliva extractors and suction cannulas .....	44
Surgical instruments (OP).....	44
Ear, nose and throat instruments (ENT) .....	45
Gynaecology (GYN) .....	46
<b>Chemical processes and technology</b> .....	<b>47</b>
<b>Adding and dispensing chemical agents</b> .....	<b>50</b>
Process chemicals .....	50
Cleaning agent .....	50
Neutralising agent.....	50
Rinsing agent.....	50
Chemical disinfectant .....	51
Instrument lubricants.....	51
Dispensing systems .....	52
Colour coding of suction lances.....	52
Replacing the canister .....	52
Rinsing agent.....	54
Setting the dispensing concentration .....	54
<b>Operation</b> .....	<b>55</b>
Selecting a programme .....	55
Programme information.....	55
Starting a programme .....	56
Selecting and deselecting additional functions .....	56
Starting a programme immediately .....	56
Starting the programme using a timer.....	56
Programme sequence indicator .....	58
End of programme.....	59
Acknowledging the end of the programme.....	59
Displaying programme information.....	59
Batch control.....	59
Cancelling a programme.....	61
Programme cancelled due to a fault .....	61
 <b>Machine functions</b> .....	<b>63</b>
Menu structure .....	63
Filter interval.....	64
Dispensing paths.....	65
Filling dispensing paths .....	65
Rinsing dispensing paths.....	66
AutoClose .....	67
Documentation.....	68
 <b>Settings</b> .....	<b>69</b>
Menu structure .....	69
Display brightness.....	69







Volume .....	70
Welcome tone.....	71
<b>Process documentation.....</b>	<b>72</b>
Logging process data .....	72
Communication modules .....	73
<b>Maintenance .....</b>	<b>74</b>
Periodic checks.....	74
Routine checks .....	75
Cleaning the filters in the wash cabinet.....	75
Cleaning the spray arms.....	77
Cleaning the machine .....	79
Checking the load carriers .....	80
Process validation .....	81
<b>Troubleshooting.....</b>	<b>83</b>
Technical faults and unexpected behaviour.....	83
Maintenance and testing.....	84
Dispensing/Dispensing systems .....	84
Insufficient salt/Water softener .....	85
Filters.....	85
Cancellation with fault number .....	86
Door.....	87
Unsatisfactory cleaning and corrosion.....	88
Spray arm monitoring/wash pressure.....	90
Noises .....	90
<b>Problem solving guide.....</b>	<b>91</b>
Cleaning the drain pump and non-return valve.....	91
Cleaning the water intake filters.....	92
<b>After sales service.....</b>	<b>93</b>
Contacting Customer Service .....	93
Notification of serious incidents .....	93
<b>Installation.....</b>	<b>94</b>
Setup and alignment.....	94
Hose holder.....	96
Lids .....	96
Building under a continuous worktop.....	97
Electromagnetic compatibility (EMC).....	98
<b>Electrical connection.....</b>	<b>99</b>
Equipotential bonding connection .....	99
<b>Plumbing.....</b>	<b>100</b>
Connection to the water supply.....	100
Connecting the drain hose.....	102
<b>Quality and safety checks .....</b>	<b>103</b>
<b>Programme chart .....</b>	<b>104</b>
Dental medicine.....	104
Minimally invasive surgery (MIS).....	104
Ear, nose and throat instruments (ENT) .....	104
Gynaecology (GYN) .....	104
Additional programmes .....	105

# Contents

---

<b>Technical data</b> .....	<b>106</b>
<b>Caring for the environment</b> .....	<b>108</b>
Disposal of the packing material .....	108

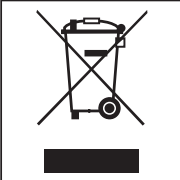
### Applicable symbols

Symbol	Key
	For warnings, see “Warnings and safety notes”
	Mandatory sign, see “Warning and safety notes”
	Observe the operating instructions
	VDE symbol
	EMC symbol of the VDE
	Do not dispose of electrical machines in household waste; they need to be disposed of separately, see “Disposal of your old machine”
CE 0297	CE marking of the EU with notified body. The corresponding declaration of conformity is enclosed with the machine and can be obtained from the manufacturer.
	Manufacturer

## Notes about these instructions

---

### Symbols and conventions used in this document

#### Warnings

 Warnings contain information which is important for safety. This alerts you to the potential danger of injury to people or damage to property.  
Read these warning notes carefully and observe the procedural instructions and codes of practice they describe.

#### Notes

Notes provide information of particular importance that must be observed.

#### Additional information and comments

Additional information and comments are contained in a simple frame.

#### Operating steps

Operating steps are indicated by a black square bullet point.

##### Example:

- Select an option.

#### Display

Display text can be identified from the special font.

##### Example:

Save.

### Definition of terms

#### Machine

In these operating instructions, the laboratory washer is referred to as “the machine”.

#### Load items

The term “load items” is used wherever the items to be processed are not defined in any further detail.

#### Load carrier

Unless otherwise specified, all components and parts for holding load items are referred to as load carriers, e.g. mobile units, baskets, modules, inserts, injector nozzles, etc.

#### Process chemicals

All media dispensed during a programme sequence are generally referred to as process chemicals, e.g. cleaning agents.

#### Wash water

The term “wash water” refers to water or to a mixture of water and process chemicals.

#### Cycle

Machine-based cleaning and reprocessing procedures are generally referred to as cycles.

## Machine overview

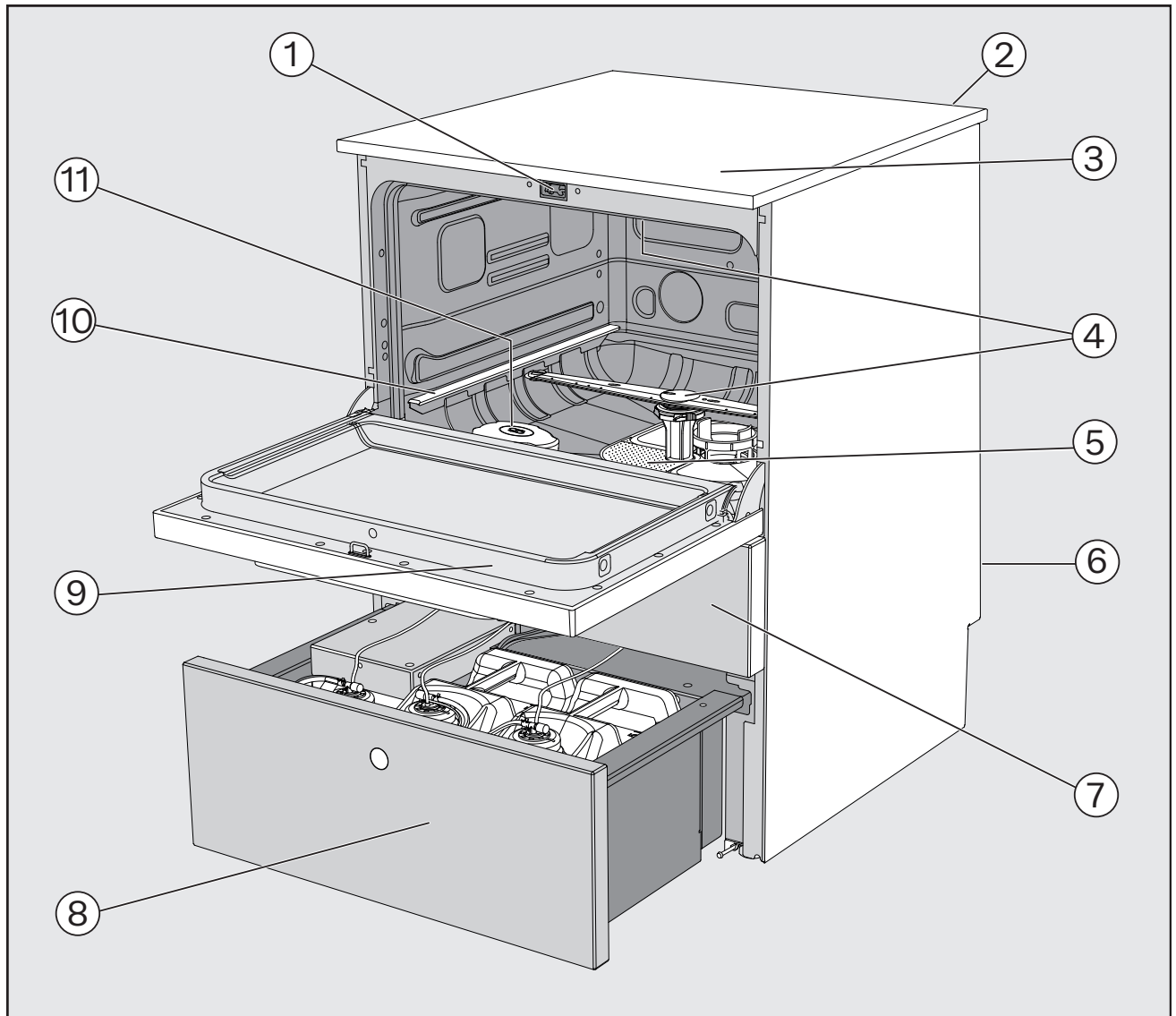

- ① Door lock
- ② Module slot for XKM communication module
- ③ Test point for validation (Top, front right; may only be visible with lid removed)
- ④ Machine spray arms
- ⑤ Filter combination
- ⑥ Rear:
  - Electrical and water connections
- ⑦ Service flap
- ⑧ Drawer with containers and connections for process chemicals (DOS drawer)
- ⑨ Data plate
- ⑩ Lower basket runners
- ⑪ Salt container

# Guide to the appliance



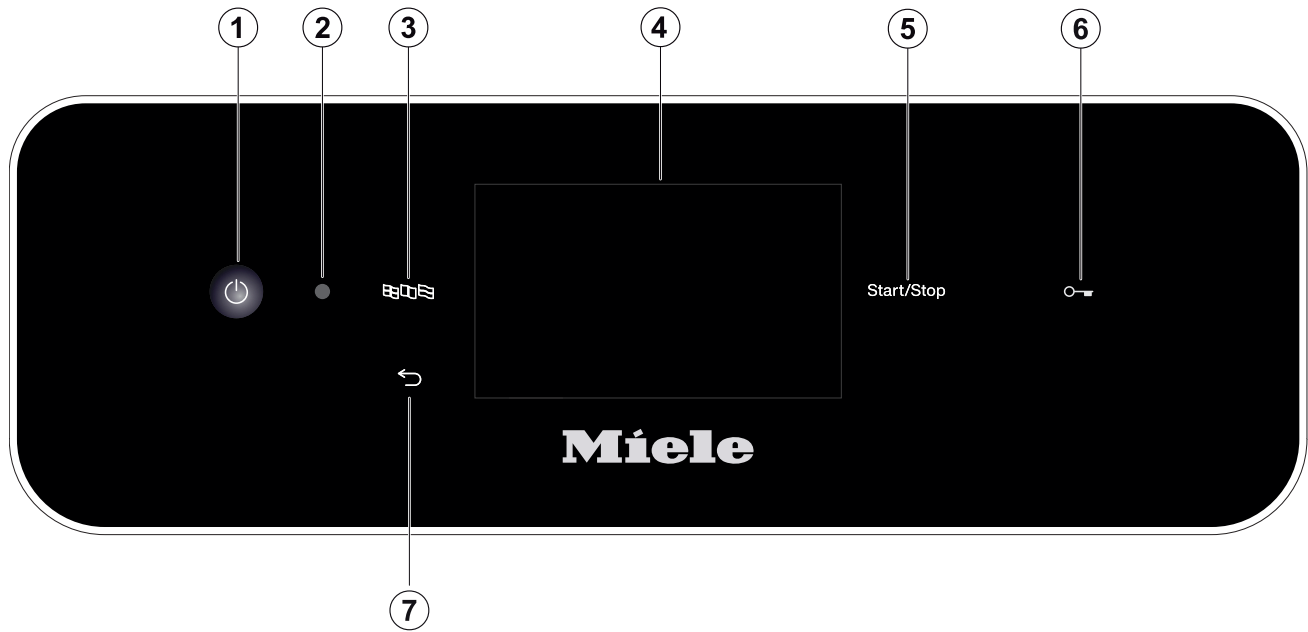

## Control panel



- ① On/Off sensor control  
For switching the machine on and off
- ② Service interface  
Testing and transmission point for Miele Customer Service
- ③ button (language selection)  
For selecting the display language
- ④ Touch display  
For displaying and selecting control elements
- ⑤ *Start/Stop* button  
For starting or cancelling a programme
- ⑥ sensor control (door lock)  
Opening (unlocking) or closing (locking) the door
- ⑦ button (cancel or back)  
For cancelling a process in the user interface (not for cancelling programmes)

### Sensor controls on the control panel

Most of the sensor controls on the control panel are backlit with LEDs (light-emitting diodes). These have the following meaning during operation.

Sensor control	LED	Status
	<b>ON</b>	The display language can be changed.
	<b>ON</b>	A process on the display can be cancelled.
	<b>OFF</b>	The display shows the top menu level.
		A programme is running.
<i>Start/Stop</i>	<b>ON</b>	A programme is running.
	<b>Pulsing</b>	Display ON: - A programme has been selected but not yet started. Display OFF: - The machine is in Standby mode.
	<b>FLASHES RED</b>	A fault has occurred (see  "Problem solving guide").
	<b>OFF</b>	A programme has finished.
	<b>ON</b>	The door is engaged in the door lock and can be opened (unlocked) or closed (locked) by pressing the button.
	<b>OFF</b>	The door is not engaged in the door lock.
		A programme is running.

### General description

This Miele washer-disinfector is a medical device as defined in the Medical Device Regulation MDR (EU) 2017/745.

Washer-disinfectors are used to wash and thermally disinfect reprocessible medical devices.

### How it works

Medical products are cleaned and disinfected using processes validated by the user in which the water quality and temperature as well as the process chemicals and system components used are selected based on the nature of the soiling and the types of medical product being reprocessed.

Thermal disinfection usually takes place during the final rinse.

According to the  $A_0$  concept described in EN ISO 15883-1, thermal disinfection occurs at 80 °C (5 °C, -0 °C) with 10 min holding time ( $A_0$  600), or at 90 °C (5 °C, -0 °C) with 5 min holding time ( $A_0$  3000), depending on the disinfection result required.

The use of suitable load carriers (baskets, modules, inserts, etc.) is important to ensure adequate reprocessing of the medical devices.

### Medical use

The cleaning result, achieved by means of the Vario TD procedure, for example, must ensure that reprocessible medical devices can be disinfected correctly, that subsequent sterilisation can be carried out and that items can be used again safely.

To ensure standardisation, medical devices should ideally be reprocessed using machine-based cleaning processes.

### Purpose

This Miele washer-disinfector can be used to clean, rinse, disinfect and, depending on the type of device, dry reprocessible medical devices in healthcare institutions such as dental/medical practices, hospitals, outpatient clinics or veterinary practices. It is also essential to heed the information issued by the manufacturers of the medical devices (EN ISO 17664), as well as the information issued by the process chemical manufacturers.

Depending on the application, complete drying must be ensured after the medical devices have been reprocessed.

For further areas of application or additional programmes, please contact Miele Customer Service.

### Intended user group

The washer-disinfector may only be used by trained dentistry/medical professionals, such as dental/medical assistants, who have the necessary level of specialist knowledge to reprocess medical devices.

### Conditions of use

The installation must be carried out in rooms in which ambient conditions meet the following requirements:

- Draught-free and dry
- Equipped with suitable room ventilation
- Solid and even surface, observe floor load-bearing capacity
- No direct sunlight
- Ambient temperature: 5 °C to 40 °C
- Relative humidity:
  - Max. 80 % for temperatures up to 31 °C
  - Linear decrease to 50 % for temperatures up to 40 °C
  - Min.: 10 %
- Altitude above sea level: up to 2.000 m

The washer-disinfector may only be connected in conjunction with a residual current device.

### Application restriction

Flexible endoscopes or products with reprocessing recommendations stating that they are not suitable for reprocessing in washer-disinfectors should not be reprocessed.

The machine is not intended for reprocessing disposable items that may be reprocessed in line with Regulation (EU) 2017/745.

The machine must not be operated in locations in which ambient conditions do not meet the following requirements:

Operation (according to IEC/EN 61010-1):	5 °C to 40 °C
Ambient temperature	80 % for temperatures up to 31 °C
Max. relative humidity	50 % for temperatures up to 40 °C
linear decrease to	10 %
Min. relative humidity	
Altitude above sea level (according to IEC/EN 61010-1)	Up to 2.000 m

### Foreseeable misuse



Flexible endoscopes and single-use items or products that are not intended to be reprocessed in washer-disinfectors must not be reprocessed.

Failure of the operator to comply with routine checks and regular service intervals.

Failure to observe the specified installation requirements.

### Daily operators

For day-to-day use, operators must be instructed on the basic functions and how to load the machine and must also be trained regularly. They must have knowledge of machine reprocessing of medical devices.

Day-to-day work is carried out using the user level and in the  Machine functions and  Settings menus. The menus are freely accessible to all users.

### Administration

More advanced tasks, e.g. interrupting or cancelling a programme, require more detailed knowledge about the machine reprocessing of medical devices.

Alterations to the reprocessing process or adaptations to the machine, components, accessories used or on-site conditions require additional specific knowledge of the machine.

Validation processes assume specialist knowledge about machine reprocessing of medical devices, the processes involved and applicable standards and legislation.

The  Extended settings menu incorporates all administrative processes and settings. This is protected by a PIN code.

This machine conforms to current safety requirements. Inappropriate use can, however, lead to personal injury and material damage. Read the operating instructions carefully before using this machine. Pay attention in particular to the residual risks, which are described in the operating instructions in  "Warning and safety notes". This will help protect users from personal injury and help prevent damage to the machine.

Keep these operating instructions in a safe place.

### Correct application

► Use of the machine is only permitted for the applications expressly approved in the operating instructions. Alterations or conversion of the machine, or using it for purposes other than those for which it was intended, are not permitted and could be dangerous.

The cleaning and disinfection processes are only designed for medical devices which are designated reprocessable by the manufacturer. Instructions issued by load and instrument manufacturers must be heeded.

► Observe the warning and safety notes provided by the load item manufacturers and their instructions on how to handle the load items correctly.

► This machine is intended for indoor use only.

### Risk of injury

#### Please pay attention to the following notes to avoid injury

► The machine may only be commissioned, repaired and maintained by Miele Customer Service or a qualified service technician authorised by the manufacturer of the machine. A Miele service contract is recommended to ensure full compliance with the normative and regulatory provisions. Incorrect repairs can cause considerable danger to users.

► Do not install the machine in an area where there is any risk of explosion or of freezing conditions.

► In order to reduce the risk of water damage, the area around the machine should be limited to furniture and fittings that are designed for use in commercial environments.

► Some metal parts pose a risk of injury/being cut. Wear cut-resistant protective gloves when transporting and setting up the machine.

► The machine must not be installed in the immediate vicinity of room doors. When the wash cabinet door is open, it could block the room doors, locking people in or out. If the wash cabinet door also protrudes into the walkway, it poses a tripping hazard and could block possible escape routes.

► If the machine is installed under a worktop, it must be installed under a continuous worktop which is firmly secured to adjacent units to achieve the necessary stability.

► The electrical safety of the machine can only be guaranteed when it is correctly earthed. It is essential that this standard safety requirement is observed and regularly tested. If in any doubt, please have the electrical installation inspected by a qualified electrician.

► A damaged or leaking machine can pose a threat to your safety. Always switch off a damaged or leaking machine immediately and contact Miele Customer Service.

## Safety instructions and warnings

---

- ▶ Label machines which have been taken out of operation and secure them against being switched on again without authorisation. The machine may only be put back into operation once it has been successfully repaired by Miele Customer Service or by an appropriately qualified specialist.
- ▶ Personnel operating the machine should be trained regularly. Untrained personnel must not be allowed access to the machine or its controls.
- ▶ Only use process chemicals which have been approved by their manufacturer for the relevant application. The manufacturer of the process chemicals is liable for any negative influences on the material of the load and the machine.
- ▶ Take care when handling chemical agents. These may contain irritant, corrosive or toxic ingredients.  
Please observe the chemical agent manufacturer's safety instructions and safety data sheets.  
Wear protective gloves and goggles.
- ▶ The machine is designed for operation with water and recommended additive chemical agents only. Organic solvents and flammable liquid agents must not be used in it.  
This could cause an explosion, damage rubber or plastic components in the machine and cause liquids to leak out of it.
- ▶ The water in the cabinet must not be used as drinking water.
- ▶ Do not lift the machine by protruding parts such as the control panel or the opened service flap as these could be damaged or torn off.
- ▶ Do not sit or lean on the opened door. This could cause the machine to tip up and be damaged or cause an injury.
- ▶ Do not sit or lean on the opened dispenser drawer. This could cause the machine to topple over and become damaged.
- ▶ Be careful when sorting items with pointed ends. Position them in the machine so that you will not hurt yourself or create a danger for others.
- ▶ Broken glass can result in serious injury when loading or unloading. Broken glass items must not be processed in the machine.
- ▶ When using this machine in the higher temperature ranges, be especially careful not to scald or burn yourself or come into contact with irritant substances when opening the door. Where disinfecting agents are used there is a danger of inhaling toxic fumes.
- ▶ Where there is a risk of toxic or chemical substances occurring in or leaking into the suds solution (e.g. aldehyde in the disinfecting agent), it is essential to regularly check door seals and make sure that the steam condenser is functioning correctly. Opening the machine door during a programme interruption carries particular risks in such circumstances.
- ▶ Should personnel accidentally come into contact with toxic vapours or chemical agents, follow the emergency instructions given in the manufacturer's safety data sheets.
- ▶ If a programme is interrupted or cancelled, the inside of the wash cabinet may be contaminated in various ways depending on the application, e.g. with pathogenic germs, toxic or carcinogenic substances, etc. Appropriate protective measures must be taken when opening the wash cabinet door, e.g. the use of gloves.

- ▶ Load carriers and load items must be allowed to cool down before removal. Empty any remaining water into the wash cabinet or an on-site slops basin before removing items.
- ▶ Never clean the machine or near vicinity with a water hose or a pressure washer.
- ▶ The machine must be disconnected from the mains electricity supply before any maintenance or repair work is carried out.
- ▶ There may be a risk of slipping if liquid is spilt on the floor depending on the type of flooring and footwear being worn. Keep the floor dry where possible and take care to clean up any liquid spills straight away. Take the necessary precautions when cleaning up hazardous substances and hot liquids.

### Quality assurance

**The following points should be observed to assist in maintaining quality standards when processing medical devices, in order to protect patients, and to avoid damage to the loads being cleaned.**

- ▶ If it is necessary to interrupt a programme in exceptional circumstances, this may only be done by authorised personnel.
- ▶ The supervisor must verify and document the results of the reprocessing procedure. This includes final checks of the cleaning results for each cycle and assessment of the applied and achieved process parameters.
- ▶ For thermal disinfection, use temperatures and temperature holding times to achieve the required infection prophylaxis in accordance with current health and safety regulations.
- ▶ Make sure items being washed are suitable for machine reprocessing and are in good condition. Plastic items must be thermally stable. Nickel plated items and aluminium items can be machine processed using special procedures only. Items containing iron, and soiling containing residual rust must not be placed in the cabinet.
- ▶ Medical devices are reprocessed by means of thermal disinfection. Heat-sensitive load items (e.g. theatre shoes) can be disinfected using a chemical disinfectant. To do this, a special reprocessing programme must be provided by Miele Customer Service. Disinfection parameters are based on claims made by the disinfectant manufacturer. Please observe, in particular, their instructions on handling, operating conditions and effectiveness. Chemo-thermal procedures of this type are not suitable for the reprocessing of medical devices.
- ▶ Under certain circumstances, process chemicals may damage the machine. The recommendations issued by manufacturers of process chemicals must be followed. Contact the machine manufacturer in the event of damage and any suspicion of material incompatibility.
- ▶ Instrument care products based on paraffin oils (white oils) can damage the elastomers and plastic in the machine. Such care products must not be dispensed as chemical agents in this machine even if they are recommended for machine use by the care product manufacturer.

## Safety instructions and warnings

---

- ▶ Abrasive substances must not be placed in the machine as they could cause damage to the mechanical components of the water supply. Any residues of abrasive substances on items to be washed must be removed without trace before reprocessing in the machine.
- ▶ Pre-treatments with cleaning or disinfecting agents can create foam, as can certain types of soiling and chemical agents. Foam can have an adverse effect on the disinfection and cleaning result.
- ▶ Processes must be set up such that foam cannot escape from the wash cabinet. It would hinder the correct functioning of the machine.
- ▶ The process used must be monitored on a regular basis by the supervisor to check foaming levels.
- ▶ To avoid the risk of damage to the machine and any accessories used with it caused by chemical agents, soiling and any reaction between the two please read the notes in “Chemical processes and technology”.
- ▶ Even when a process chemical, e.g. cleaning agent, is recommended by the manufacturers of the process chemical, the machine manufacturer takes no responsibility for the effect of such process chemicals on the load items.  
Please note that changes in product formulation, storage conditions, etc. which are not announced by manufacturers of process chemicals may impair the quality of cleaning results.
- ▶ When using process chemicals, always consult the instructions issued by individual manufacturers. Process chemicals must only be used for the purpose they are designed for by the manufacturer to avoid any material damage or the occurrence of very strong chemical reactions (e.g. oxyhydrogen explosion).
- ▶ Always follow the relevant manufacturer’s instructions on storage and disposal of process chemicals and their containers.
- ▶ Particles  $\geq 0,8$  mm are removed by the filters in the wash cabinet. Smaller particles may find their way into the circulation system. For this reason, reprocessing narrow-lumened load items requires additional filtering of the wash water.
- ▶ If the cleaning result is subject to particularly stringent requirements, e.g. in chemical analysis, the operator must carry out regular quality control to ensure that required standards of cleanliness are being achieved.
- ▶ Load carriers which hold the load items must be used only as intended.  
Lumened load items must be thoroughly cleaned, internally and externally, with the wash water.
- ▶ Secure small and light items with cover nets or place in a mesh tray for small items, so that they do not block the spray arms.
- ▶ Empty any containers or utensils before loading them.
- ▶ The amount of residual solvents and acids on items going into the cabinet should be minimal.  
There should be no more than a trace of any solvents with a flash point of below 21 °C.
- ▶ Chloride solutions, in particular hydrochloric acid, must not be placed in the cabinet.
- ▶ Ensure that solutions or steam containing chlorides or hydrochloric acid do not come into contact with the stainless steel outer casing of the machine in order to avoid any damage through corrosion.

- ▶ After any plumbing work the water pipework to the machine will need to be vented. If this is not done, components can be damaged.
- ▶ The gaps between a built-in machine and adjacent cabinetry must not be filled e.g. with silicone sealant as this could compromise the ventilation to the circulation pump.
- ▶ Please follow the advice on installation in these operating instructions and the installation plan.

### Use of components and accessories

- ▶ Only use original spare parts and accessories from the manufacturer, which are suitable for the application they are required for. Model designations are available from Miele.
- ▶ Only use original load carriers from the machine manufacturer. Using load carriers made by other manufacturers or making modifications to original accessories can result in an unsatisfactory cleaning and disinfection result.

### Symbols on the machine

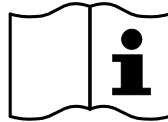

Warning:  
Observe the operating instructions!

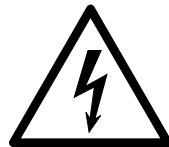

Warning:  
Danger of electric shock!



Warning: Hot surfaces:  
It can be very hot inside the wash cabinet when the door is opened!



Risk of being cut:  
Wear cut-resistant protective gloves when transporting and setting up the machine!

### Disposing of your old machine

- ▶ Please note that the machine may have contamination from blood, bodily fluids, pathogenic germs, facultative pathogenic germs, genetically modified material, etc. in it and must be decontaminated before disposal. For environmental and safety reasons ensure the machine is completely drained of any residual water, chemical residues and cleaning agent. Observe safety regulations and wear safety goggles and gloves. Make the door lock inoperable, so that children cannot accidentally shut themselves in. Then make appropriate arrangements for its safe disposal.

## Operation via control panel



The machine is usually operated via the control panel, which has an integrated touch display and various sensor controls.

The sensor controls are backlit with LEDs and are only displayed in context, i.e. if they can be operated in conjunction with the display. Otherwise, they are not visible and cannot be selected.

The touch display and sensor controls react to touch.

The control panel with sensor controls and the touch display can be scratched by pointed or sharp objects, e.g. pens.  
Only touch the control panel with your fingers or special pens for touch displays which have rubber tips (touch pens).

Every touch on the sensor controls is confirmed by a keypad tone. You can adjust the volume of the keypad tone or switch it off on the display, see ▶  Settings ▶ Volume.

## Display screens

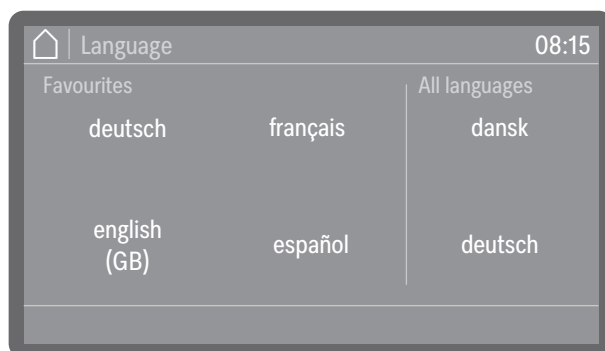

All display screens shown in these instructions are examples and may differ from the actual display screens.

## Switching on

The machine must be connected to the electrical supply.



- Press the  On/Off sensor control until the Miele logo appears on the display.

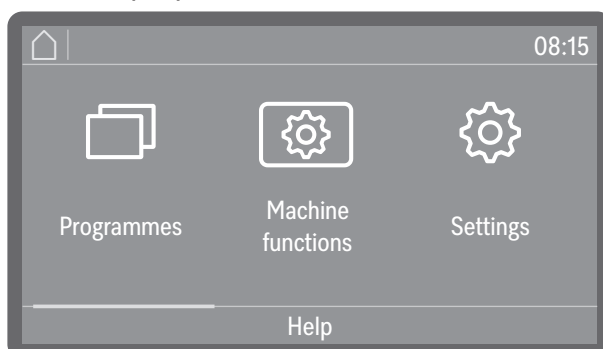

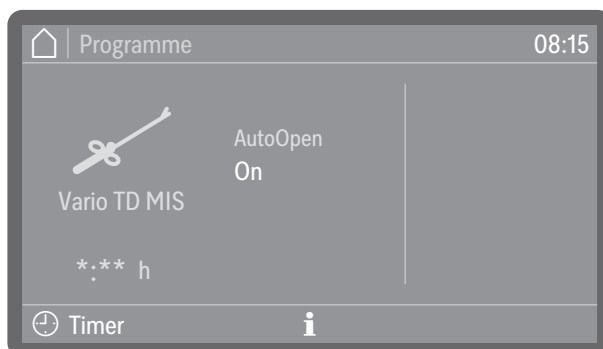

As soon as the machine is ready for operation, the display changes and shows the menu selection.



(\*: \*\* Programme running time varies depending on configuration)

If the Memory function is activated, the most recently started programme is displayed.

**Tip:** The Memory function can be activated or deactivated at  Extended settings  Programme options  Memory.

If the machine is being used for the first time, or if the factory default settings have been reinstated, some basic parameters, e.g. language, date, time, etc., must first be set.

### Switching off

- Press the  On/Off sensor control for a few seconds.

The machine then goes into Standby mode for approx. 1 minute before it switches off completely.

### Standby/Off

If the machine has not been used for approx. 10 minutes, it can be set to Standby mode or switched off automatically.

### Standby

In Standby mode, the machine remains switched on and the *Start/Stop* sensor control pulses. The machine can be reactivated by pressing the *Start/Stop* sensor control, touching the display or opening the door.

### Off

After automatic switch-off, the machine is switched off and can be switched on again by pressing the  On/Off sensor control.

### Touch display

### Home button

As soon as you have opened a menu or the programme selection, the home button  is activated in the top left of the display. This will take you back to the menu selection at any time.

### Scroll bar

The coloured scroll bar appears in the lower part of the display if there are more selection options available than can be displayed.

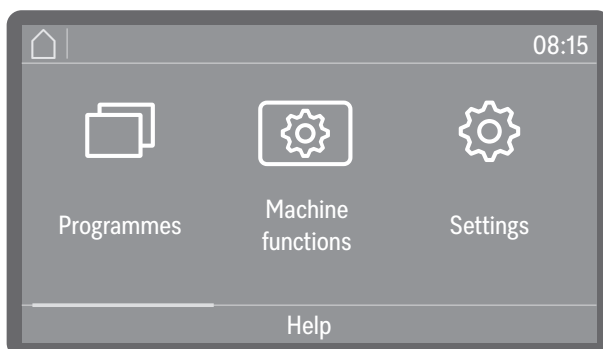

You can scroll right or left by swiping your finger across the screen. To do this, place your finger on the touch display and swipe it in the direction you want.

## Inputs on the display

In these operating instructions, the descriptions for operating the menus are shown as follows:

The input path describes the sequence to follow to access the menu level in question. The listed menu options have to be selected individually on the touch display.

It is not always necessary to follow the complete path. For example, if you have already opened one of the upper levels of the input path, you can continue to follow the path from this level.

Example:



Example 2:

▶ Machine functions ▶ Filter interval ▶ Filter combination

## Display and options

All setting options from the menus are presented as a list with a short explanation. Preselected options are highlighted in colour. The further procedure is then described.

Example:

### ■ Select a filter.

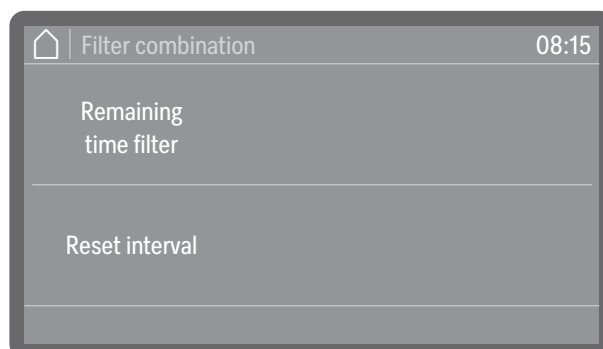

- Remaining filter cycles or Remaining time filter (depending on the type of filter selected)

Displays the remaining programme sequences (cycles) or operating hours until the next maintenance (cleaning or replacement)

- Reset interval

Resets the counters for the filter cycles

⚠ The intervals must only be reset once the filters have been cleaned or replaced.

### ■ Select an option.

## Operation

### Setting numerical values

Numerical values can be entered in 2 different ways.

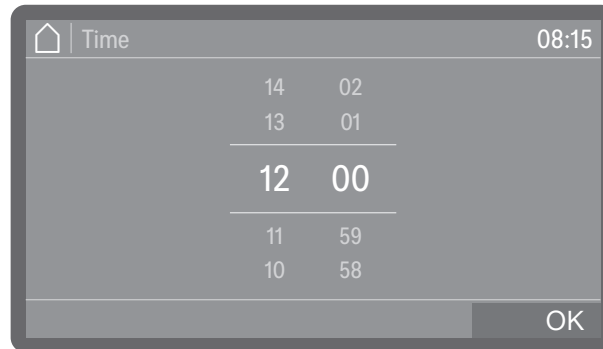

Firstly, you can place a finger on the numbers highlighted in colour and change them by swiping up or down.

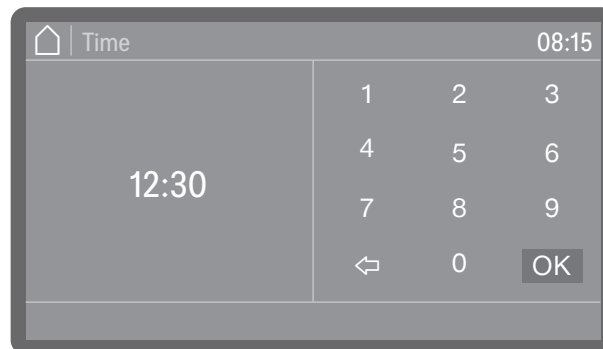

Secondly, you can call up a numerical keypad by briefly tapping the numbers highlighted in colour and then entering the numbers directly.

Depending on the context, numbers entered directly may be rounded up or down. If, for example, it is only possible to enter values in increments of 10 (10, 20, 30, etc.), the value is rounded down to 10 when you enter 12, and rounded up to 20 when you enter 15.

### Selecting the language

You can change the display language at any time.

- Press the language selection sensor control  next to the display.

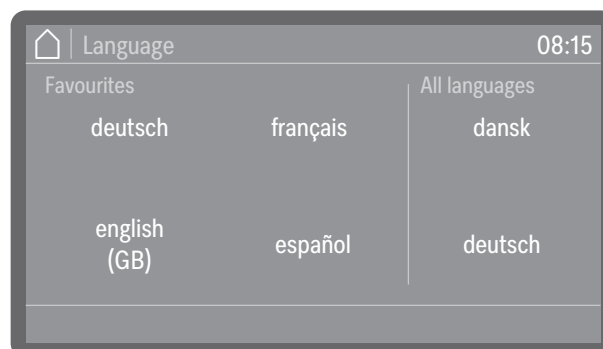

- Scroll to the language you want and select it by tapping it.

The order of the languages in the display is variable. The more often a programme is started in the selected language, the further forward the language moves in the sequence. The 4 most frequently selected languages are shown on the display as Favourites.

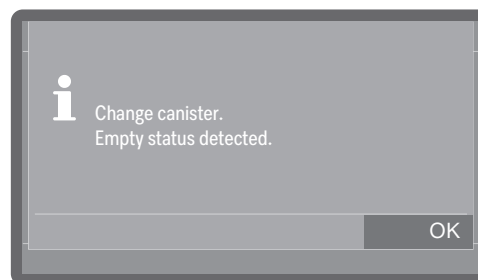
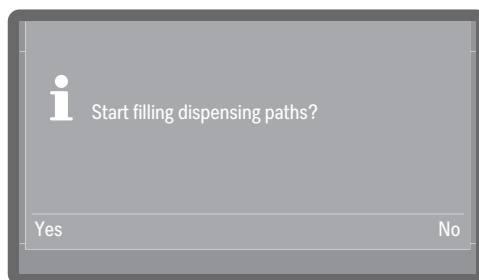

## System messages **i**



System messages are indicated by the information symbol **i**. These give information about current processes and the status of the machine. If there is more than one system message, they are shown one after the other and – depending on the message – must be processed or acknowledged individually.

## Fault messages



In the event of a fault, a warning symbol  appears on the display and the *Start/Stop* sensor control flashes red in rapid succession. If buzzer tones are activated, a warning tone will also sound. Warning messages must be acknowledged by tapping the warning symbol. Troubleshooting assistance can be found in  "Problem solving guide".

## Help button

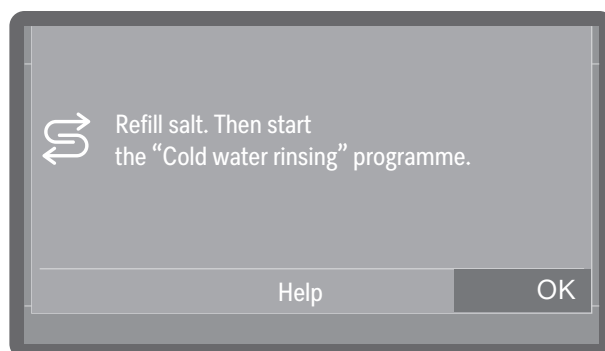

If the Help button appears at the bottom of the display, you can display assistance for operation or troubleshooting. If required, tap the Help button and allow the machine to guide you through the process step by step.

### Networking (📶 or L)

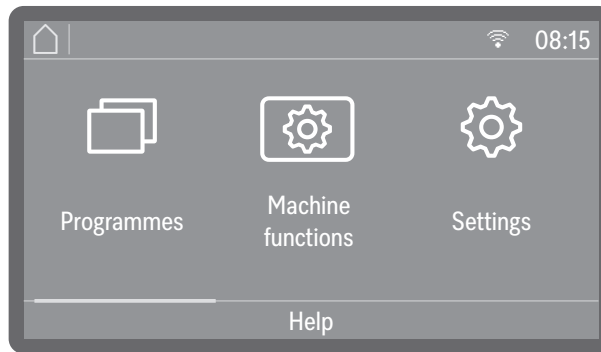

If the machine has been networked, a symbol for the available interface is shown at the top of the display. 📶 stands for a WiFi connection, L for a wired LAN connection. If the machine cannot establish a WiFi connection with the router, the symbol will be shown with a cross through it ✖.



**Tip:** The interface is set up at ▶ ⚙️ Extended settings ▶ Network.

### Comfort door lock

The door of the wash cabinet is equipped with a Comfort door locking mechanism. When the door is closed, the Comfort door locking mechanism automatically pulls the door into the closed position and thus ensures it is sealed. The door is locked electronically.

### Opening the door

A door that has been locked electronically can be opened under the following circumstances:

- The machine is connected to the power supply and the  On/Off sensor control is lit up.
- The symbol for the  door sensor control is lit up.
- To open the door, press the  door sensor control.

The comfort door lock opens the door slightly.



- Open the door. The control panel serves as a door handle. Grasp the handle underneath the control panel and pull the door down to open it.

The temperature in the wash cabinet may be higher after a programme cycle. If the temperature exceeds 60 °C, a message is shown on the display when you press the  door sensor control: Hot wash cabinet: Risk of injury, take care when opening the door..

- Confirm the message by pressing OK.

### Closing the door

- Make sure that no objects or load items protrude into the closing area of the door.

 Risk of injury caused by crushing.  
Do not put your hand inside the door as it is closing. Risk of crushing.

- Raise the door upwards until the catch engages.

If the AutoClose function is activated, the door is then pulled into the end position.

**Tip:** For more information on the AutoClose function, see

- ▶  Machine functions ▶ AutoClose.

## Opening and closing the door

### Opening the door using the emergency release

**⚠ Danger of scalding, burning and chemical burns!**  
If the emergency release is operated during a programme sequence, hot water and process chemicals can escape. Where disinfectants are used, there is also a danger of inhaling toxic fumes.  
Only open the door using the emergency release when strictly necessary.

The emergency release mechanism is located on the right beside the door lock in the gap between the door and the lid of the machine or the worktop.

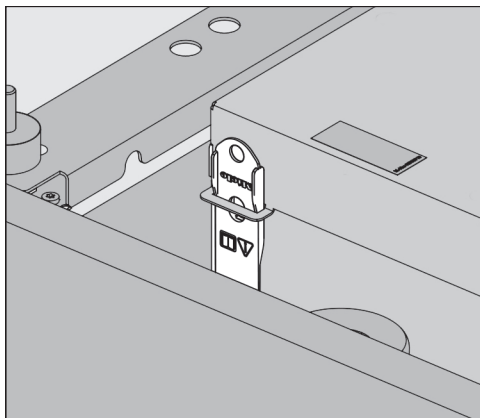

- Open the dispenser drawer and remove the yellow tool for releasing the door. The tool is located in a holder on the left-hand side.
- Press against the door to release the emergency release mechanism.

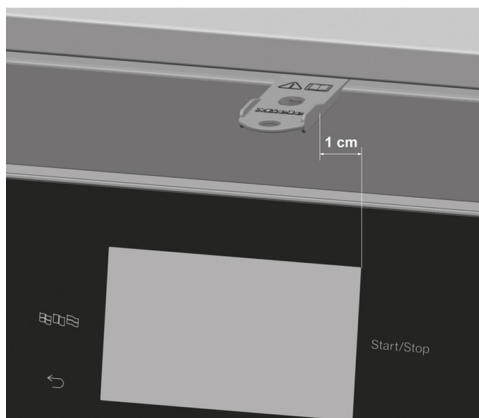

- Insert the tool horizontally into the gap between the door and the lid or worktop. The distance between the right edge of the tool and the right edge of the display must be approx. 1 cm.
- Press the tool against the release mechanism until you hear the door open. Continue to press the tool against the release mechanism and fully open the door.

If the machine is switched on, the following message is shown on the display when the emergency release is triggered:

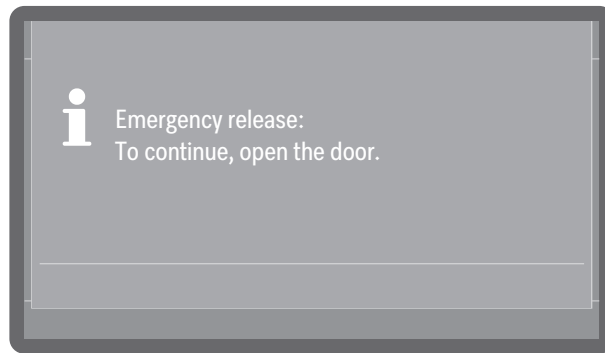

- Open the door a little to acknowledge the message.

## Water hardness

### Water softening

In order to achieve excellent cleaning results, the machine requires a supply of soft water with a low calcium content. Hard mains water results in the build-up of calcium deposits on the load items and on the wash cabinet walls.

Fresh water with a water hardness of 0.7 mmol/l (4 °dH) or more must be softened. This occurs automatically while a programme is running in the built-in water softener.

The water softener must be set to the exact hardness of the mains water.

If the water hardness is greater than 9,0 mmol/l (50 °dH), the water must be softened before water intake.

For this purpose, the water connections on site must be equipped with appropriate water softening systems that provide the required minimum flow pressures for the water connections, see  "Technical data".

Determine the water hardness of the pre-softened water and set the value on the display.

### Setting the water hardness

#### Determining the degree of hardness

You can find out the degree of hardness of the fresh water from your local water supplier.

As an alternative, you may also determine the approximate water hardness by using the test strip included with the machine.

- Take a water sample at the nearest water connection.

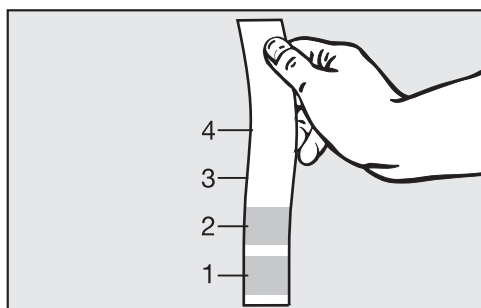

- Dip the test strip into the water for approx. 1 second. The zones of the test strip must be fully immersed.
- Remove the test strip from the water and shake the excess water off the test strip.

After approx. 1 minute, and based on the colouration, you will be able to read the water hardness.

Test strip	Water hardness	Settings on the display
4 green zones	< 3 °dH	3 °dH or lower
1 red zone	> 4–7 °dH	7 °dH
2 red zones	> 7–14 °dH	14 °dH
3 red zones	> 14–21 °dH	21 °dH
4 red zones	> 21 °dH	*)

\*) Contact your local water supplier, enquire about the degree of hardness and set this on the display.

## Setting the degree of hardness

With varying water hardness, always set the highest level. If the water hardness fluctuates between, for instance, 1.4 and 3.1 mmol/l (8 and 17 °dH), the water hardness must be set to 3.1 mmol/l (17 °dH).

Water hardness setting values can be found in  "Settings table".

The menu is saved under the following input path.

 Extended settings

Water hardness

- Select the Water hardness menu option.

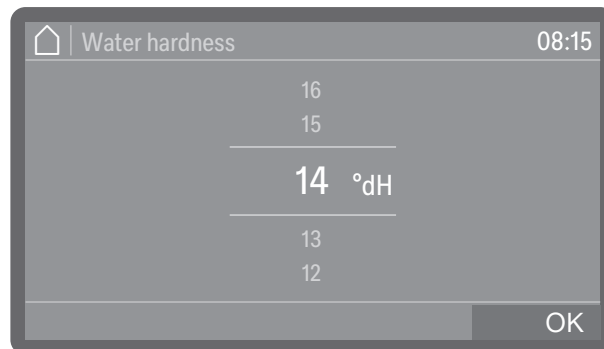

- Set the water hardness.
- Press OK to save the setting.

# Water hardness

## Settings

Water hardness can be set between 0 and 9,0 mmol/l (0–50 °dH).  
The water hardness is preset to 2,5 mmol/l (14 °dH) ex-works.

°dH	°f	mmol/l	Display
0	0	0	<b>0</b>
1	2	0.2	<b>1</b>
2	4	0.4	<b>2</b>
3	5	0.5	<b>3</b>
4	7	0.7	<b>4</b>
5	9	0.9	<b>5</b>
6	11	1.1	<b>6</b>
7	13	1.3	<b>7</b>
8	14	1.4	<b>8</b>
9	16	1.6	<b>9</b>
10	18	1.8	<b>10</b>
11	20	2.0	<b>11</b>
12	22	2.2	<b>12</b>
13	23	2.3	<b>13</b>
<b>14</b>	<b>25</b>	<b>2.5</b>	<b>14*)</b>
15	27	2.7	<b>15</b>
16	29	2.9	<b>16</b>
17	31	3.1	<b>17</b>
18	32	3.2	<b>18</b>
19	34	3.4	<b>19</b>
20	36	3.6	<b>20</b>
21	38	3.8	<b>21</b>
22	40	4.0	<b>22</b>
23	41	4.1	<b>23</b>
24	43	4.3	<b>24</b>
25	45	4.5	<b>25</b>

°dH	°f	mmol/l	Display
26	47	4.7	<b>26</b>
27	49	4.9	<b>27</b>
28	50	5.0	<b>28</b>
29	52	5.2	<b>29</b>
30	54	5.4	<b>30</b>
31	56	5.6	<b>31</b>
32	58	5.8	<b>32</b>
33	59	5.9	<b>33</b>
34	61	6.1	<b>34</b>
35	63	6.3	<b>35</b>
36	65	6.5	<b>36</b>
37	67	6.7	<b>37</b>
38	68	6.8	<b>38</b>
39	70	7.0	<b>39</b>
40	72	7.2	<b>40</b>
41	74	7.4	<b>41</b>
42	76	7.6	<b>42</b>
43	77	7.7	<b>43</b>
44	79	7.9	<b>44</b>
45	81	8.1	<b>45</b>
46	83	8.3	<b>46</b>
47	85	8.5	<b>47</b>
48	86	8.6	<b>48</b>
49	88	8.8	<b>49</b>
50	90	9.0	<b>50</b>

\*) Factory default setting

### Reactivation salt

The water softener must be reactivated at regular intervals. Special reactivation salt is required for this. Reactivation is carried out automatically during a programme sequence.

If the water hardness is consistently less than 0.7 mmol/l (4 °dH), salt is not required for the water softener. However, the water hardness level must still be set, see  "Setting the water hardness".

### Filling the container for reactivation salt

Only use special coarse-grained reactivation salt or pure evaporated salt with a grain size of around 1–4 mm.

Never use any other kind of salt, e.g. table salt, animal feed salt or de-icing salt. Other salts may contain insoluble additives which can impair the functioning of the water softener.

 Inadvertently filling the salt container with cleaning agent will always cause serious damage to the water softener.

Before filling the salt container, make sure that you have picked up the right packet of reactivation salt.

The salt container cap is located at the bottom of the wash cabinet next to the spray arm.

- Open the door.
- Remove the load carrier.

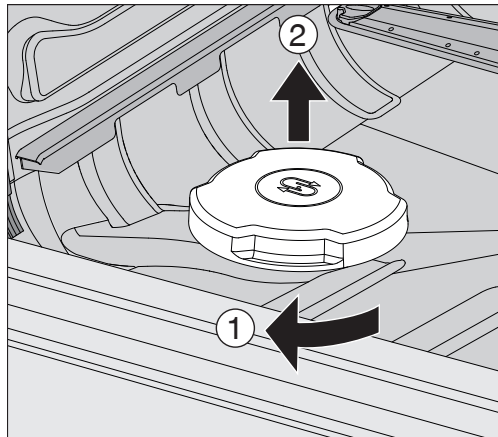

- Turn the salt container cap in the direction of the arrow ① as far as it will go and pull the cap upwards ②.

Before filling the salt container for the first time, you must fill it with approx. 2,0 l of water to enable the salt to dissolve. Once the machine has been commissioned, there is always sufficient water in the container.

## Water hardness

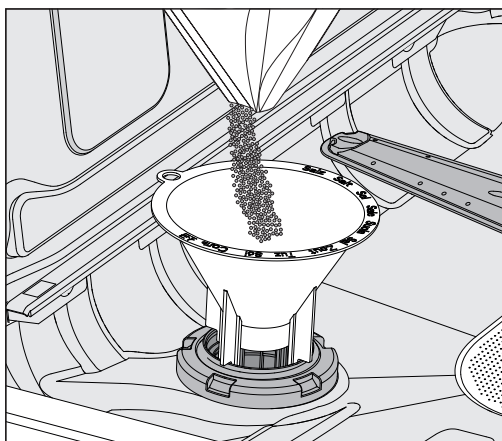

- Place the salt funnel on the refilling opening.

The container takes approx. 1.4–2 kg of salt, depending on the type of salt and the remaining fill level.

- Add the salt. Do not add any more than 2 kg of salt.

As the salt container is being filled, displaced water (brine) may run out.

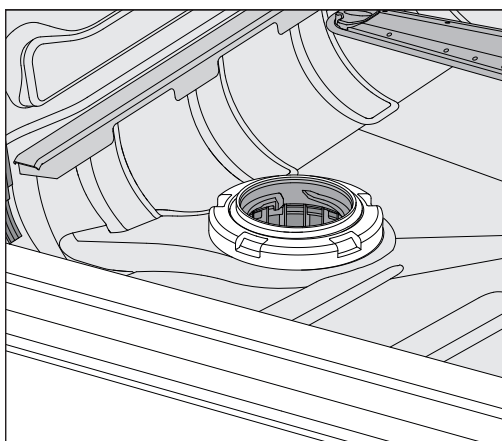

- Clean any excess salt from around the opening of the container, focusing especially on the container's seal. Do not use running water to rinse away salt residues as this can cause the container to overflow.
- Close the container. Make sure that the container is closed tightly so that no wash water can enter the container.

⚠ Do not force the container shut if it has been overfilled. If an overfilled salt container is forced shut, this may damage the container.  
Remove excess salt before closing the container.

- Run the Cold water rinsing programme after refilling the salt.

This will ensure that any traces of salt and brine are dissolved, diluted and rinsed away.

Excess salt and brine which has overflowed cause corrosion damage if they are not rinsed away.

**Salt refill indicator** If the fill level in the salt container is low and reactivation is carried out, the following message appears on the display:

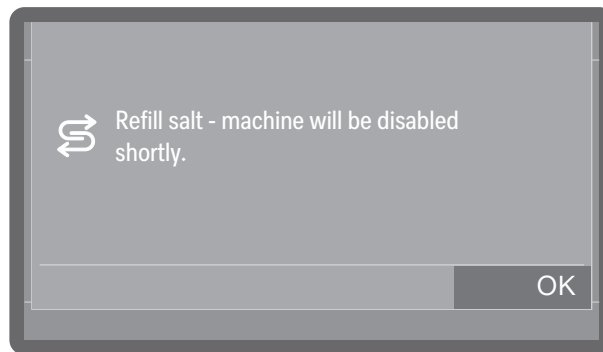

- Press **OK** to confirm the message.
- Top up the reactivation salt, see  "Filling the container for reactivation salt".

If the message is being displayed for the first time, further programme cycles may be possible depending on the set water hardness. If no salt is added, the message is displayed again at the end of every programme.

Reactivation notification

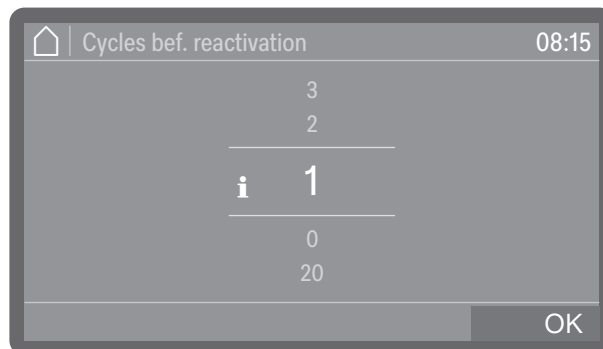

You can set how many programme cycles in advance you want to be notified of the upcoming reactivation, see ▶  Extended settings ▶ Maintenance/Service ▶ Note reactivation.

## Water hardness

---

### labelling machine lock due to lack of salt

If the salt in the water softener has been used up, a fault appears on the display and the machine is locked to prevent further use.



- Acknowledge the fault by tapping the warning symbol.

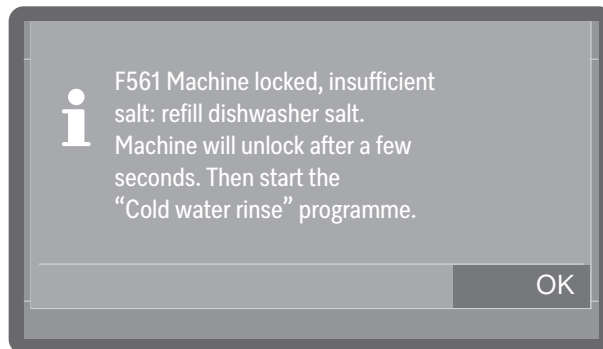

- Follow the instructions on the display and top up the reactivation salt, see  "Filling the container for reactivation salt".

The machine lock is lifted automatically with a certain delay once salt has been added.

### Baskets, modules and inserts

The cleaning machine can be equipped with a lower basket which can be fitted with different inserts and modules or exchanged for special accessories depending on the type and shape of the load items.

Select load carriers and other accessories which are appropriate for the application.

Information on the individual areas of application can be found on the following pages as well as in the operating instructions for the load carriers (if available).

For all areas of application defined in  "Intended use", Miele offers suitable load carriers and special irrigation connectors. Contact Miele for more information.

Programme must not be started without lower basket.

Before starting each programme, make sure that the machine is equipped with a suitable lower basket, even if the basket is empty. It is not permitted to operate the machine without a lower basket.

### Water supply

Load carriers with irrigation connectors are equipped with one or several connectors for the water supply at the rear. When these are slid into the machine, the connections couple automatically with the water supply ports in the rear panel of the wash cabinet. The load carriers are held in position by the wash cabinet door when it is closed. Unused ports in the rear panel of the wash cabinet are closed mechanically.

### Wash pressure measurement

The wash pressure can be measured on all load carriers with spray arms, injector manifolds or other wash connections, e.g. during performance tests and validations in accordance with EN ISO 15883.

#### Test point for measuring wash pressure

On load carriers with injector manifolds or other wash connections, there is a connection on the injector manifold or a wash connection for wash pressure measurement. The exact location is described in the respective operating instructions for the load carriers.

If the test point for measuring the wash pressure is located in the water inlet pipe, the test point is labelled with a ⚠ warning symbol and closed with a blind stopper.

#### Performing the measurement

⚠ Risk of infection due to insufficient cleaning and disinfection. Test points labelled with a ⚠ warning symbol do not have sufficient cleaning and disinfection performance. Do not connect load items or irrigation connectors to the test points under any circumstances.

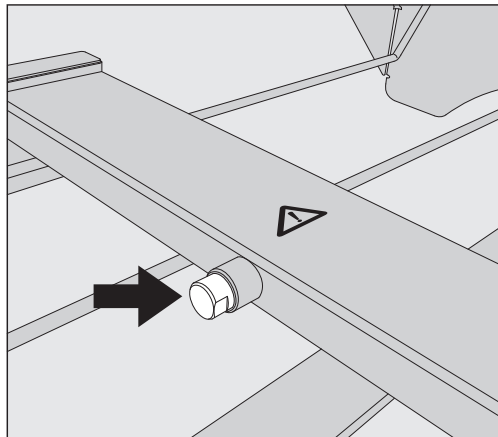

- To measure the wash pressure, replace the blind stopper with a Luer Lock adapter.

Suitable Luer Lock adapters, such as the E 447, are available from Miele.

- Carry out the measurement.
- Close the test point again with the blind stopper after the measurement.

### Preparing the load items

⚠ Contaminated load items pose a health risk.

Contaminated load items can result in various hazards to health, which can lead to infections, poisoning, injuries or more depending on the type of contamination.

When working with contaminated load items, ensure that all necessary measures are taken to protect personnel.

Wear protective gloves and use appropriate equipment.

⚠ Only load items which have been declared by their manufacturer as suitable for machine reprocessing may be reprocessed. The manufacturer's specific reprocessing instructions must be observed.

Used disposable items must not be reprocessed.

⚠ Risk of injury caused by load.

There is a risk of injury when loading and unloading due to possible sharp edges, rims or pointed ends.

To minimise the risk of injury, loading should take place from the back forwards and unloading should take place in the reverse order.

- Special load carriers or irrigation connectors such as nozzles, irrigation sleeves or adapters may be required for appropriate internal cleaning, depending on the load items.
- Arrange the load items so that the wash water can access all surfaces. This ensures thorough and proper cleaning.
- Do not place load items so close together that cleaning is hampered.
- Do not place load items inside other items where they may be concealed, as this will hamper cleaning.
- Lumened load items must be thoroughly cleaned, internally and externally with wash water. Special load carriers or irrigation connectors are required for this, depending on the load items.
- Ensure that load items with long, narrow lumens can be flushed through properly before placing them in or connecting them to an irrigation connector.
- Hollow vessels should be inverted and placed in the correct load carriers to ensure that wash water can flow in and out of them unrestricted.
- Deep-sided load items should be placed at an angle to make sure the wash water runs off them freely.
- Tall, narrow, hollow items should be placed in the centre of the baskets. This ensures better water coverage.
- Take apart any load items which can be dismantled according to the manufacturer's instructions and process the individual parts separately from each other.
- Lightweight load items should be secured with cover nets to prevent them from spinning around in the wash cabinet and blocking the spray arms.

## Areas of application

---

- Only reprocess small items and micro components in special inserts, mesh trays with lids or mesh inserts.
- The spray arms must not be blocked by load items which are too tall or which hang down in their path.
- Broken glass and ceramics can result in serious injury when loading or unloading. Damaged glass or ceramic load items must not be reprocessed in the machine.
- Nickel and chrome-plated load items and load items made of aluminium are not generally suitable for machine reprocessing. Special process conditions are required for these load items.
- We recommend that you only use instruments made of stainless steel, which is not susceptible to corrosion.
- Plastic load items must be thermally resistant.

Suitable load carriers and irrigation connectors as well as other accessories are available from Miele.

### Preparing the load items

 Danger of explosion due to flammable gases.  
Flammable solvents with a flash point below 21 °C outgas and can generate a flammable mix of gases.  
Only place load items into the wash cabinet that are wetted with traces of solvents at most.  
Start a reprocessing programme immediately after loading.

 Material damage due to solvents.  
Solvents can damage the elastomers and plastics of the machine and lead to leaks.  
Only place load items into the wash cabinet that are wetted with traces of solvents at most.  
Start a reprocessing programme immediately after loading.

 Material damage due to corrosion.  
Chloride solutions, particularly hydrochloric acid, and ferrous materials that can rust or corrode cause corrosion on the stainless steel of the machine and the load carrier.  
Do not introduce any chloride solutions into the wash cabinet.  
Do not introduce any ferrous materials that can rust or corrode into the wash cabinet.

 Contaminated load items pose a health risk.  
Contaminated load items can result in various hazards to the health, which can lead to infections, poisoning, injuries and more depending on the type of contamination.  
When working with contaminated load items, ensure that all necessary measures are taken to protect personnel, e.g. wearing protective gloves.

- Follow the load item manufacturer's instructions regarding pre-cleaning and pre-treatment.

- Empty all load items before loading into the machine and pay particular attention to relevant regulations.
- Disassemble the load items according to the instructions of the load item manufacturer.
- Place small parts and micro components in suitable small parts baskets to secure them.
- Open available taps and valves or remove them according to the manufacturer's instructions and place the individual parts in suitable small parts baskets.
- Thoroughly rinse load items which have been pre-treated with chemicals, see  "Wet loading".

### Dry loading

Contaminated medical devices should be placed directly into the load carriers after use without pre-treatment.

Dry loading is preferable for contaminated medical devices.

### Wet loading

Chemically pre-treated load items must be rinsed thoroughly by hand or with a suitable rinsing programme before the machine reprocessing procedure to avoid a significant build-up of foam.

 Risk of infection due to protein adhesion. Unsuitable chemical pre-treatment agents can lead to the denaturation of protein soiling, which may be difficult to remove by machine reprocessing. Only use suitable pre-treatment agents. Carry out manual pre-cleaning if necessary. If possible, avoid chemical pre-treatment.

- For machine rinsing, use the Cold water rinsing programme.

### Checks before starting a programme

#### Carry out a visual check before starting every programme:

- Are the load items correctly loaded and connected for cleaning?
- Was the recommended loading template followed?
- Can the lumen/narrow sections of hollow load items be accessed by the wash water?
- Are the spray arms clean and do they rotate freely?
- Is the filter combination clean and securely fitted?  
Remove any coarse soiling and clean the filter combination if necessary.
- Are the removable modules, nozzles, irrigation sleeves and other irrigation connectors securely connected?
- Are the load carriers with nozzles, irrigation sleeves and other irrigation connectors correctly connected to the water supply?
- Are all process chemical containers sufficiently filled?

## Areas of application

---

### After reprocessing

#### Tests

#### Check the following at the end of every programme:

- Carry out a visual check of the load items for cleanliness.
- Are all lumened load items still attached to the appropriate nozzles?

⚠ Risk of infection due to insufficient cleaning and disinfection. Load items that become detached from the irrigation connector during reprocessing will not be sufficiently cleaned and disinfected on the inside. Any load items that become detached from the irrigation connector during reprocessing must be reprocessed again.

- Are the lumens of hollow load items free from obstructions?
- Are the nozzles and connections securely held in position in the load carriers?

Carry out maintenance, care and functional checks. After reprocessing, carry out all maintenance and care measures specified by the manufacturers of the load items as well as the necessary functional tests.

#### Recontamination

Take appropriate measures to prevent recontamination of processed items, e.g.:

- Wear clean gloves when removing the wash load.
- Remove the entire wash load from the carriers before reloading them.

#### Protein test

Cleaning results should be subjected to periodic protein tests, e.g. weekly.

### Dental medicine

#### Instruments

Deposits that can harden or contain grinding particles must be removed manually from the instruments immediately after the patient has been treated, e.g. with a swab. Examples of deposits include dental cement, composite, polishing paste or similar.

Instruments with particularly complex functional ends or very stubborn deposits may require ultrasonic pre-treatment.

 Risk of injury caused by load.  
There is a risk of injury when loading and unloading due to possible sharp edges, rims or pointed ends.  
To minimise the risk of injury, loading should take place from the back forwards and unloading should take place in the reverse order.

#### Transmission instruments

Examples of transmission instruments include dental turbines and contra-angle handpieces.

Transmission instruments with **solid light guides** can be regarded as durable, whereas **fibre optic bundles** can be susceptible to more rapid wear.

Use a neutral to mildly alkaline liquid cleaning agent for cleaning. Where there is build-up of deposits, a citric acid-based neutralising agent should be dispensed.

The wash water must be filtered prior to internal cleaning so that the narrow channels in transmission instruments do not become blocked with treatment residues from the wash water. The A 315 injector module should therefore be used for reprocessing transmission instruments, in conjunction with the re-usable A 800 tubular filter and the

A 803 holder for transmission instruments or the AUF 1 holder.

The injector module, the tubular filter and the AUF 1 holder each come with their own operating instructions.

- After reprocessing, the insides of the transmission instruments must be dried with sterile compressed air before being cleaned and sterilised as appropriate in accordance with the manufacturer's instructions. Please observe national regulations.

Before using transmission instruments again following reprocessing, a function check must be carried out, e.g. by spraying into a basin, to ensure they are clear.

#### Mouth mirrors

 Risk of damage due to machine reprocessing procedure.  
Not all glass mouth mirrors can be reprocessed by machine.  
Always follow the manufacturer's instructions.

Rhodium-coated mouth mirrors, because of their delicate surface, must be loaded in such a way that the mirror surfaces cannot sustain mechanical damage during reprocessing, e.g. by knocking against other instruments.

## Areas of application

---

### Saliva extractors and suction cannulas

Saliva extractors and suction cannulas must be positioned upright so that they are completely rinsed through by the wash water.

Use special accessories for reprocessing saliva extractors and suction cannulas:

- Surgical suction cannulas must be placed on the nozzles of the A 315/1 injector module.
- Saliva extractors and suction cannulas that are made of plastic and have a wide opening can be reprocessed in the APWD 329 insert. Alternatively, the items can also be placed in the small compartments of the APWD 062 insert for dental instruments.

### Mouth rinsing cups

Opal glass is particularly suitable for reprocessing in a cleaning machine.

### Surgical instruments (OP)

The duration between using instruments and reprocessing them should be kept as short as possible, and must not exceed 6 hours.

Surgical instruments – and those used for minimally invasive surgery – must be disinfected thermally. To avoid stains on and corrosion of the load, the final rinse should preferably be carried out with demineralised water. There is a risk of corrosion if operating water with a chloride content exceeding 100 mg/l is used.

 Due to the risk of injury when placing instruments with probes pointing upwards in an upright position, the instruments should be loaded from the rear to the front and unloaded in the reverse order.

To allow the wash water to flow through lumened instruments/channels, they must be disassembled according to the manufacturer's instructions. Caps and seals must be removed and any taps must be opened.

Narrow-lumened instruments must be manually pre-rinsed where necessary. Follow the instrument manufacturer's instructions.

### Hinged instruments

Open the hinged instruments and place them in the mesh trays; they must not cover each other.

### Optical instruments

 Risk of damage due to mechanical influences.

Optical instruments may be damaged if the washing mechanics move them.

Always reprocess optical instruments in inserts made by the optical instrument manufacturer or in the special E 460 insert.

Only reprocess optical instruments which have been designated as reprocessable by machine by their manufacturer.

### Ear, nose and throat instruments (ENT)

Load items must only be reprocessed in load carriers designed for them and using programmes tailored to the application.

Load carriers are supplied with their own operating instructions.

Please use a special insert such as the E 417/1 for reprocessing ear and nasal speculum.

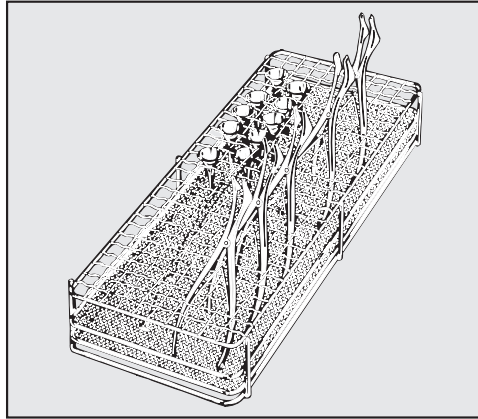

- To ensure coverage of all surfaces by the wash liquor please open speculum and place in the insert.

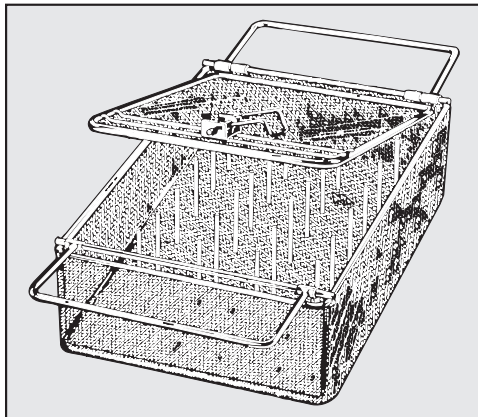

Lightweight ENT instruments e.g. ear speculum can be reprocessed in a lockable E 374 insert.

Please be aware that thin chrome plating can be very sensitive to neutralising agent.

### ENT fibre optics

⚠ To avoid mechanical damage, only reprocess ENT optical instruments in inserts made by the optic manufacturer or in special inserts such as the E 460.

- Pre-clean the instruments before machine reprocessing, e.g. with a non-fixative disinfecting agent or a swab soaked in ethanol.

## Areas of application

---

### Gynaecology (GYN)

Load items must only be reprocessed in load carriers designed for them and using programmes tailored to the application.

Use special inserts for reprocessing gynaecological specula, e.g. the E 416.

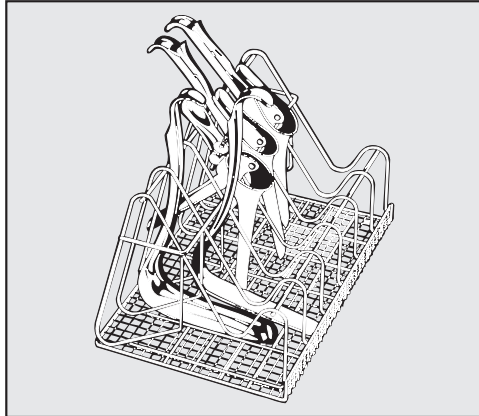

Load the insert as shown in the illustration.

- One-part specula:** ■ Open and place between the struts of the insert.
- Two-part specula:** ■ Place the lower parts in the narrow compartments of the insert, on the left in the illustration.  
■ Place the upper parts in the wide compartments of the insert, on the right in the illustration.

Arrange the specula between two struts so that they do not touch or cover each other.

## Chemical processes and technology

In this section, you will find a description of the causes of common chemical reactions which can occur between different types of soiling, process chemicals and the components of the machine, along with their remedies as necessary.

This section is intended as a guide. If unforeseen interactions occur during reprocessing or if you have any queries on this subject, please seek advice from Miele.

General information	
Problem	Measures
<p>If elastomers (hoses and seals) and plastics in the cleaning machine are damaged, for example by swelling, shrinking, hardening or brittleness of materials, tears and cracks, components will not function correctly and this generally leads to leaks.</p>	<ul style="list-style-type: none"> <li>- Determine and remedy the causes of the damage.</li> </ul> <p>See also the information on “Process chemicals”, “Soiling” and “Reaction between process chemicals and soiling” in this section.</p>
<p>A heavy build-up of foam during the programme sequence will impair the cleaning and rinsing effect on the load items. Foam escaping from the wash cabinet can cause damage to the cleaning machine.</p> <p>When foam develops, the cleaning process cannot be guaranteed to be standardised and validated.</p>	<ul style="list-style-type: none"> <li>- Determine and remedy the causes of the foam.</li> <li>- Check the process used regularly to monitor foaming levels.</li> </ul> <p>See also the information on “Process chemicals”, “Soiling” and “Reaction between process chemicals and soiling” in this section.</p>
<p>Corrosion to stainless steel in the wash cabinet and to accessories can have various appearances:</p> <ul style="list-style-type: none"> <li>- Rust (red marks/discolouration)</li> <li>- Black marks/discolouration</li> <li>- White marks/discolouration (etched surface)</li> </ul> <p>Corrosive pitting can lead to the cleaning machine not being water-tight. Depending on the application, corrosion can affect cleaning and washing results or cause corrosion of (stainless steel) load items.</p>	<ul style="list-style-type: none"> <li>- Determine and remedy the causes of corrosion.</li> </ul> <p>See also the information on “Process chemicals”, “Soiling” and “Reaction between process chemicals and soiling” in this section.</p>

## Chemical processes and technology

Process chemicals	
Problem	Measures
<p>The ingredients in process chemicals have a strong influence on the longevity and functionality (throughput) of the dispensing system.</p>	<ul style="list-style-type: none"> <li>- Follow the process chemical manufacturer's instructions and recommendations.</li> <li>- Carry out a regular visual check of the dispensing system (suction lances, hoses, canisters, etc.) for any damage.</li> <li>- Regularly check the flow rate of the dispensing system.</li> <li>- Ensure that the regular cycle of maintenance is observed.</li> <li>- Please contact Miele for advice.</li> </ul>
<p>Process chemicals can damage elastomers and plastics in the cleaning machine and accessories.</p>	<ul style="list-style-type: none"> <li>- Follow the process chemical manufacturer's instructions and recommendations.</li> <li>- Carry out a regular visual check of any accessible elastomers and plastics for damage.</li> </ul>
<p>The following process chemicals can cause large amounts of foam to build up:</p> <ul style="list-style-type: none"> <li>- Cleaning agents and rinsing agents containing surfactants</li> </ul> <p>Foam can occur:</p> <ul style="list-style-type: none"> <li>- In the programme block in which the process chemical is dispensed</li> <li>- In the following programme block if it has been spilt</li> <li>- In the following programme with rinsing agent if it has been spilt</li> </ul>	<ul style="list-style-type: none"> <li>- The process parameters in the wash programme, such as dispensing temperature, dosage concentration, etc., must be set to ensure the whole process is foam-free or very low-foaming.</li> <li>- Please observe the process chemical manufacturer's instructions.</li> </ul>

## Chemical processes and technology

<b>Soiling</b>	
<b>Problem</b>	<b>Measures</b>
<p>The following substances can lead to heavy build-up of foam during washing and rinsing:</p> <ul style="list-style-type: none"> <li>- Some disinfectants, cleaning agents, etc.</li> <li>- Active foaming agents such as surfactants</li> </ul>	<ul style="list-style-type: none"> <li>- Thoroughly rinse the load items in water beforehand.</li> <li>- Select a cleaning programme with at least one short pre-wash in cold or hot water.</li> </ul>
<p>The following substances can cause corrosion to stainless steel in the wash cabinet and the accessories:</p> <ul style="list-style-type: none"> <li>- Hydrochloric acid</li> <li>- Other substances containing chlorides such as sodium chloride, etc.</li> <li>- Concentrated sulphuric acid</li> <li>- Chromic acid</li> <li>- Iron particles and shavings</li> </ul>	<ul style="list-style-type: none"> <li>- Thoroughly rinse the load items in water beforehand.</li> <li>- Put the drip-dry load items into the load carriers and start a reprocessing programme as soon as possible after placing in the wash cabinet.</li> </ul>
<b>Reaction between process chemicals and soiling</b>	
<b>Problem</b>	<b>Measures</b>
<p>Stains containing high protein levels, such as blood, can cause a heavy build-up of foam when processed with alkaline process chemicals.</p>	<ul style="list-style-type: none"> <li>- Select a cleaning programme with at least one short pre-wash in cold water.</li> </ul>
<p>Non-precious metals, such as aluminium, magnesium and zinc, can release hydrogen when processed with very acidic or alkaline process chemicals (oxyhydrogen reaction).</p>	<ul style="list-style-type: none"> <li>- Please observe the process chemical manufacturer's instructions.</li> </ul>

## Adding and dispensing chemical agents

### Process chemicals

⚠ Unsuitable process chemicals pose a health risk.  
Using unsuitable process chemicals will generally cause an unsatisfactory reprocessing result and can pose a health risk or cause damage to property.  
Only use process chemicals designed specifically for use in this machine and follow the manufacturer's instructions on their use.  
Please carefully observe any instructions relating to non-toxic residues.

⚠ Process chemicals pose a health risk.  
Some process chemicals may be corrosive and irritant.  
Observe the relevant safety regulations and safety data sheets issued by the process chemical manufacturers when handling process chemicals.  
Take all protective measures required by the process chemical manufacturer, e.g. wear protective goggles and protective gloves.

Highly viscous (thick) process chemicals can affect the dispenser monitoring and lead to inaccurate data. In this instance, please contact Miele Customer Service for advice.

Contact Miele for information about suitable process chemicals.

The safety data sheets for the process chemicals must be easily accessible during operation of the machine.

### Cleaning agent

The machine is only designed for use with liquid cleaning agents. Liquid cleaning agent is dispensed from an external canister via a suction lance.

For environmental reasons it is important to always consider the following factors when selecting a cleaning agent:

- How alkaline does the cleaning agent need to be for the cleaning application involved?
- Are protein-removing enzymes required and is the programme sequence suitable for this?
- Are tensides required for proper dispersal and emulsification?
- A suitable, mildly alkaline, active chlorine-free cleaning agent should be used for thermal disinfection programmes.

For cleaning specific types of soiling, and for information on the optimum cleaning agents and additives to use for liquid dispensing, please contact Miele Customer Service.

### Neutralising agent

Neutralising agents are dispensed during the interim rinse in certain programmes to avoid discolouration and patches of corrosion on the instruments, especially in the joint areas.

In addition, neutralising agent (pH setting: acidic) neutralises residues of alkaline cleaning agents on the surface of the load items.

Neutralising agent is dispensed via an internal dispensing system.

## Adding and dispensing chemical agents

### Rinsing agent

Rinsing agent is necessary to ensure water does not cling and leave marks on load items, and to help load items dry faster after they have been reprocessed.

⚠ Residues of rinsing agent remain on the surface of load items after they have dried.

It is important to check the suitability of the rinsing agent being used.

Rinsing agent is dispensed via an internal dispensing system. Depending on the equipment variant, the dispensing system is either supplied when the machine is delivered or can be retrofitted at any time by Miele Customer Service.

### Chemical disinfectant

Heat-sensitive load items can be disinfected by adding a chemical disinfectant. The disinfectant must be suitable for machine use and must be low-foaming.

Disinfection parameters are based on claims made by the disinfectant manufacturer. Please observe, in particular, their instructions on handling, operating conditions and effectiveness.

⚠ Chemo-thermal procedures of this type are not suitable for the reprocessing of medical devices.

For this application, the machine must be provided with a special reprocessing programme and an additional dispensing system by Miele Customer Service.

### Instrument lubricants

⚠ Damage caused by instrument lubricants based on paraffin oils (white oils).

Paraffin oils (white oils) can damage the elastomers and plastics in the machine.

Such care products must not be dispensed as process chemicals in this machine, even if they are recommended for machine use by the care product manufacturer.

If necessary, you can use instrument lubricants based on paraffin oil for instrument care following machine reprocessing. Observe the instructions provided by the manufacturers of the instrument and the care products.

It is safe to reprocess instruments that have been treated with this type of care product in this machine.

# Adding and dispensing chemical agents

---

## Dispensing systems

The machine is designed for dispensing the following process chemicals:

- Cleaning agent  
Liquid cleaning agents are dispensed via an internal dispensing system.
- Neutralising agent/additive  
An additional dispensing system is required for dispensing neutralising agent or other additives. Depending on the equipment variant, this system is either supplied when the machine is delivered or must be retrofitted by Miele.
- Rinsing agent  
Rinsing agent is dispensed via an internal dispensing system.

## Colour coding of suction lances

Liquid process chemicals from external canisters are dispensed via suction lances. Colour coding can be helpful for correct dispensing.

Miele uses and recommends the following:

- Blue: for cleaning agent
- Red: for neutralising agent
- Yellow: for free choice

## Replacing the canister

 Risk of infection due to unsuitable cleaning agents.  
Using unsuitable cleaning agents, such as a cleaning agent for a domestic dishwasher, will mean that the reprocessing result is not as expected.  
Only use cleaning agents that are suitable for cleaning machines.

Only replace empty canisters with canisters containing the appropriate process chemicals.  
The reprocessing results are sometimes significantly impaired by dispensing the wrong process chemicals in the programme blocks. In addition, mixing different process chemicals in the dispensing system can lead to unexpected chemical reactions.  
Observe the colour coding of the suction lances.

## Adding and dispensing chemical agents

When the fill level in the canister is low, you are reminded to change the canister:

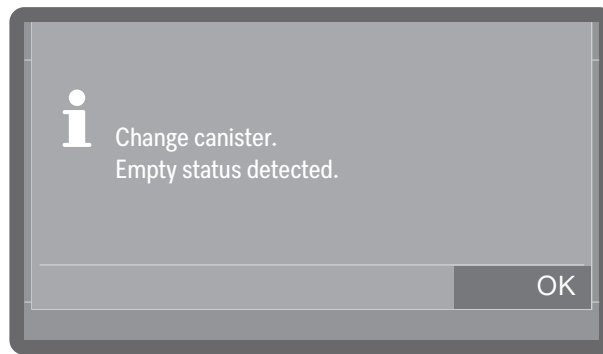

- Press **OK** to confirm the message.

Once the supply has been used up, the machine is locked to prevent further use.

The lock is lifted some time after the canister has been replaced.

- Open the dispenser drawer.
- Take the lid off the canister and remove the suction lance.

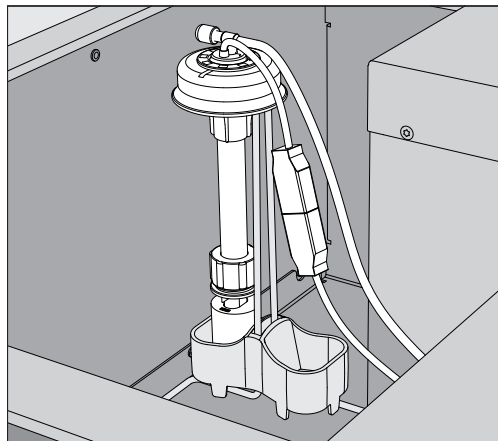

- Secure the suction lance by placing the lance in the holder provided.
- Remove the canister and place it on a robust and easy-to-clean surface.
- Replace the empty canister with a full one.

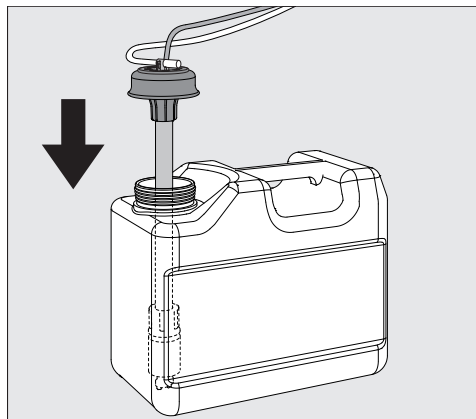

- Push the suction lance into the opening of the canister and secure the lid.
- Feed the suction lance into the canister until it reaches the bottom.

## Adding and dispensing chemical agents

---

- Wipe up any spilled process chemicals thoroughly.
- Also clean the holder for the suction lance.
- Put the canister back in the dispenser drawer.
- Close the drawer. Ensure that the dispensing hoses and cables are not kinked or trapped.

When replacing the canisters, air can get into the dispensing system and lead to inaccurate dispensing. For this reason, we recommend that you refill the dispensing system after changing the canister.

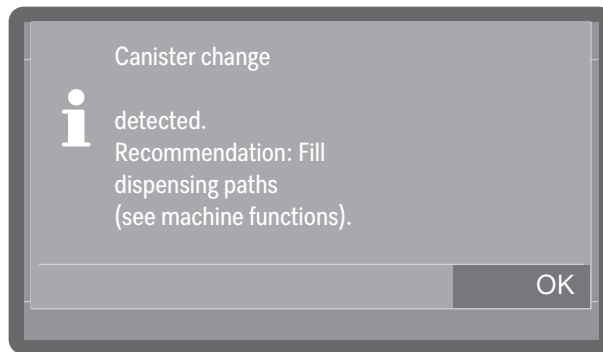

- Confirm the message by pressing OK.
- To fill the dispensing system, select the corresponding dispensing system at ▶  Machine functions ▶ Dispensing paths ▶ Fill dispensing paths and start the process. The system is filled automatically.

### Rinsing agent

#### Canister

If rinsing agent is dispensed from a canister, you can replace or refill it. The procedure for this is essentially the same as the process described in  “Replacing the canister”.

### Setting the dispensing concentration

The dispensing concentration is set by the Miele Customer Service Department.

#### Rinsing agent

If spots appear on load items after reprocessing:

- Increase the amount dispensed.

If clouding or smearing appears on load items after reprocessing:

- Decrease the amount dispensed.

#### Neutralising agent

If spots appear on load items after reprocessing:

- Decrease the amount dispensed.

If clouding or smearing appears on load items after reprocessing:

- Increase the amount dispensed.

## Selecting a programme

Always select the programme depending on the type of load and degree and type of soiling, or on infection prevention issues.

- You can find a list of all programmes along with application descriptions in “Programme overview”.
- All released programmes are available for selection.
- The order of the programmes can be changed as required.

**Tip:** To release or block programmes, see

▶ Extended settings ▶ Programme options ▶ Release programmes.

**Tip:** To change the order of the programmes, see ▶ Extended settings ▶ Programme options ▶ Set favourites.

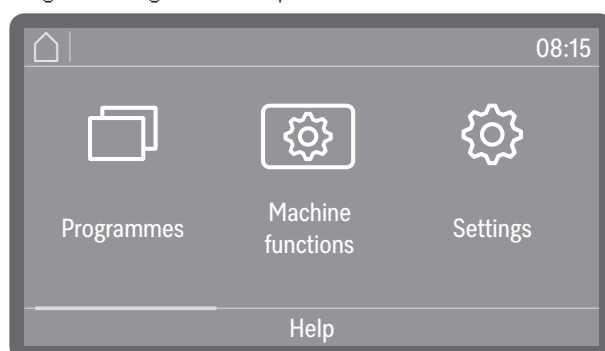

- Tap Programmes and select a programme from the list, see “Programme overview”.

As soon as you have selected a programme, the *Start/Stop* sensor control starts to flash.

Use the sensor control to return to the programme selection screen before the programme starts, e.g. to select a different programme. This is no longer possible once the programme has started.

## Programme information

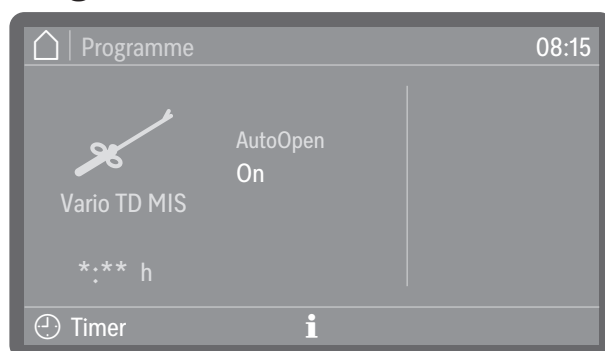

(\*:\*\* Programme running time varies depending on configuration)

In the programme display, you can use the information symbol **i** to call up information about the programme or, while a programme is running, information about the current wash block.

## Starting a programme

### Selecting and deselecting additional functions

Before starting the programme, you can activate or deactivate the additional functions that are displayed to the right of the programme name by tapping them.

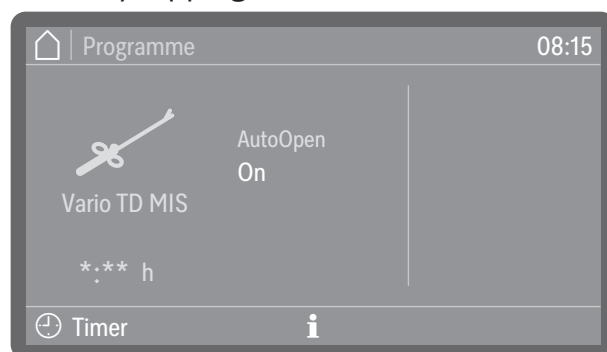

(\*:\*\* Programme running time varies depending on configuration)

Activated functions are highlighted in colour. The type and number of additional functions vary depending on the programme and machine features.

### AutoOpen

AutoOpen is an additional assisted drying function. At the end of a programme, the door opens slightly to allow residual moisture to escape from the wash cabinet more quickly.

The door is opened as soon as the temperature in the wash cabinet has dropped below a certain value. Before the door is opened, a corresponding message is shown on the display and a buzzer sounds if buzzers are activated.

### Starting a programme immediately

- Press the *Start/Stop* sensor control (the LED of the *Start/Stop* sensor control will light up).

Once a programme has been started, it can no longer be changed. You can end a programme before it has finished by cancelling it, see  "Cancelling a programme".

### Starting the programme using a timer

The start of a programme can be delayed, for example, to benefit from economy rates of electricity at night. You can set a start time at which the programme should start (*Start at*) or a finish time by which the programme should end at the latest (*Finish at*). The times depend on the set time of day.

**Tip:** To set the time of day, see ▶  Extended settings ▶ Date/ Time ▶ Time.

## Setting the timer

- Select a programme.

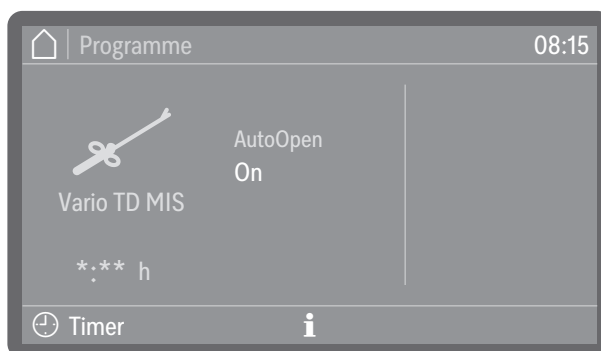

(\*:\*\* Programme running time varies depending on configuration)

- Tap  Timer.

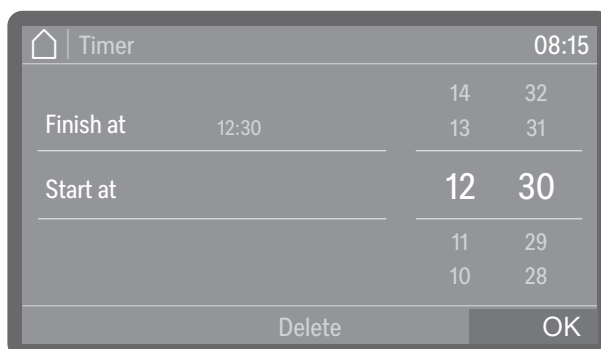

- Select the start time (Start at) or finish time (Finish at).
- Set the time.  
Selecting Delete allows you to delete the entries.
- Press OK to confirm your entries.

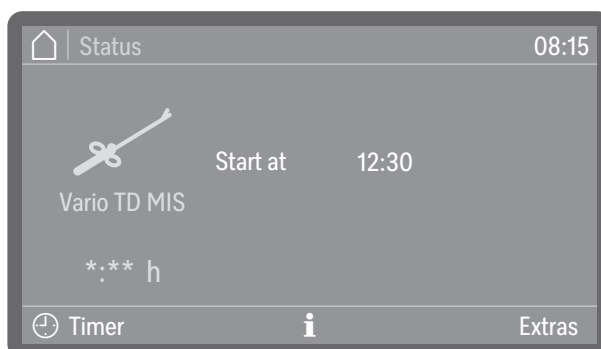

(\*:\*\* Programme running time varies depending on configuration)

This activates the timer. Depending on the programme, you can add or remove additional functions for the next programme cycle via Extras, see  “Selecting and deselecting additional functions”. Some time after the last input, the machine switches to Standby mode until the programme starts.

## Changing the timer

- Tap  Timer.
- Re-enter the start or finish time.

## Operation

Deleting the timer ■ Press the *Start/Stop* sensor control.

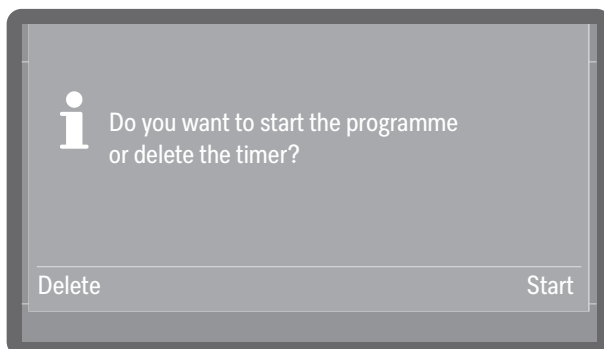

You will then be asked whether you want to start the programme immediately (*Start*) or whether you want to delete the timer (*Delete*).

■ Select an option.

**Tip:** Alternatively, you can switch off the machine by pressing the  On/Off sensor control, which automatically deactivates the timer.

### Programme sequence indicator

Once a programme has started, the display shows the programme name, the name of the current wash block and the time left until the programme is finished.

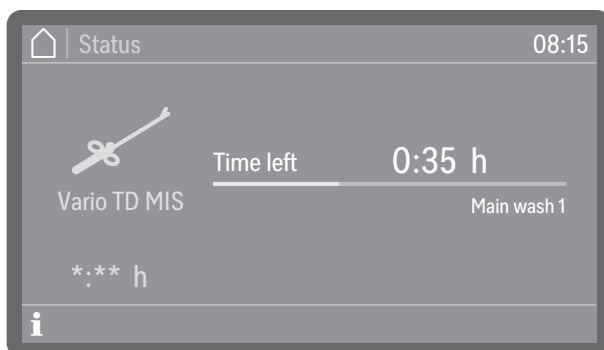

(\*.\*.\* Programme running time varies depending on configuration)

During the programme sequence, programme information can be called up by tapping the information symbol **i**.

Only the parameters that are set for the wash block that is currently in progress are shown, e.g.:

- Temperature as actual value and setpoint if a temperature has been specified for the wash block
- Holding time as actual value and setpoint if a holding time has been set
- $A_0$  value as actual value and setpoint, for wash blocks with thermal disinfection and activated  $A_0$  value control
- Cycle number

## End of programme

After a programme has ended normally, the LED of the *Start/Stop* sensor control will go out and the following will appear on the display:



The  door sensor control starts to light up to indicate that the door can be opened.

In addition, a buzzer sounds for approx. 3 seconds and is repeated 3 times every 30 seconds.

**Tip:** The buzzer settings can be found at ▶  Settings ▶ Volume ▶ Buzzer tones.

### Acknowledging the end of the programme

■ Tap the display to acknowledge the end of the programme.

If system messages are pending at this time, these are then output, e.g. if a lack of salt or process chemicals has been detected or a notification regarding when the next maintenance is due. Every message needs to be acknowledged individually by pressing OK.

### Displaying programme information

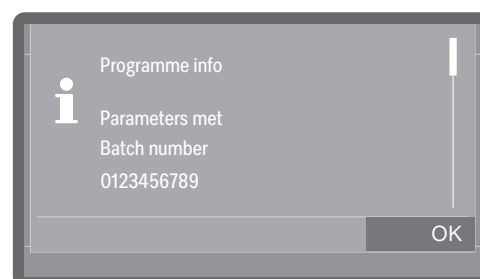
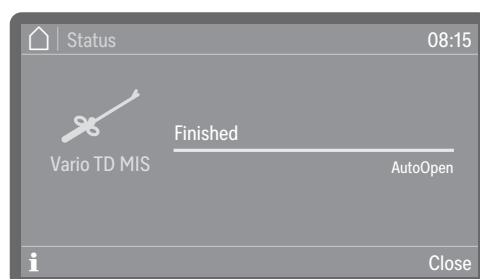

At the end of the programme, tap the information symbol **i** to call up programme information, e.g.:

- Parameters met
- $A_0$  value actual value, only with activated  $A_0$  value control
- Cycle number
- Spray arm speed as OK (OK) or Not OK (not OK) if monitoring is active
- Wash pressure as OK (OK) or Not OK (not OK) if monitoring is active

If ▶ Batch control is activated, the cycle must first be documented on the display before the programme information can be displayed.

# Operation

## Batch control

If you carry out batch controls, you can document the results in the cycle protocols of the machine. For this purpose, the function must be activated and a user ID must be set up for each authorised operator, see ▶  Extended settings ▶ Programme options ▶ Batch control.

If batch control is activated on the machine, the cleaning results of the completed programme must first be documented before the next programme can be started.

### Carrying out batch control

- Acknowledge the end of the programme.
- Tap on the information symbol **i** and check whether the displayed parameters are as expected.
- Open the door, remove the load items and carry out all the necessary checks to verify the cleaning results, e.g. visual checks.
- Close the door and document the result on the display.

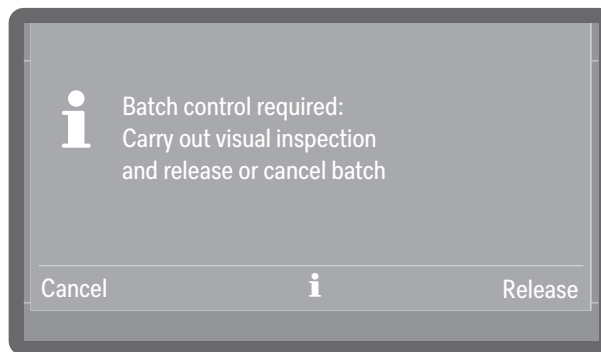

- Release

The cleaning results meet expectations.

- Cancel

The cleaning results are inadequate.

Do not continue to use load items from cancelled cycles. The load items must either be reprocessed or disposed of.

- Select one of the options.

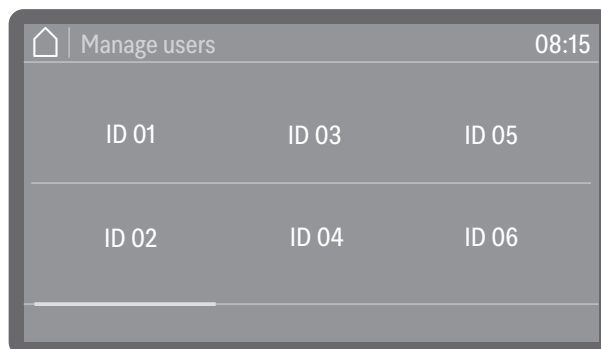

- Select your user ID.

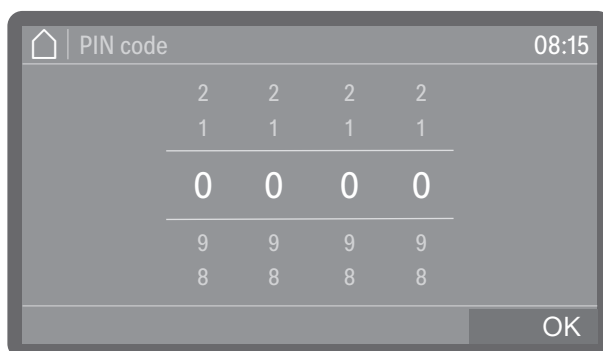

- Enter your personal PIN code, see “PIN code”.

If the PIN code is repeatedly entered incorrectly, the process will be cancelled and the result will not be documented. Instead, the failed result documentation will be recorded in the cycle protocol.

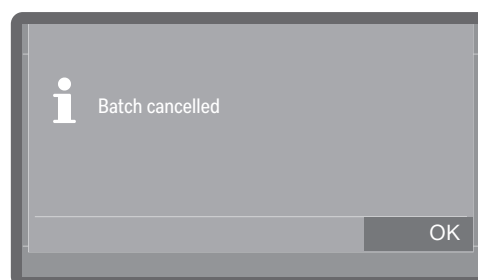

- Press **OK** to confirm the result of the batch control.

The cleaning results will be documented in the cycle protocol together with the user ID.

Personal PIN codes must not be shared.  
The PIN code identifies the owner of the user ID at the machine. If the personal PIN code becomes public knowledge, it is no longer possible to trace which operator used the user ID for the documentation.

## Cancelling a programme

If a programme is cancelled, the load items must be reprocessed again.

**Danger of scalding, burning and chemical burns due to hot load items, wash water or escaping vapours.**  
The load items and the wash cabinet may be very hot. Hot wash water or steam may also escape.  
Be careful when opening the door. Open the door slowly and do not stand in the rising vapours.

### Programme cancelled due to a fault

The programme stops and a fault message appears on the display.

- Acknowledge the fault message by entering your PIN code.
- Take appropriate steps to resolve the fault, depending on its cause, see “Problem solving guide”.

## Operation

### Cancelling a programme manually



A programme that is in progress may only be cancelled if strictly necessary, e.g. if the load items are moving significantly.

- Press the *Start/Stop* sensor control.

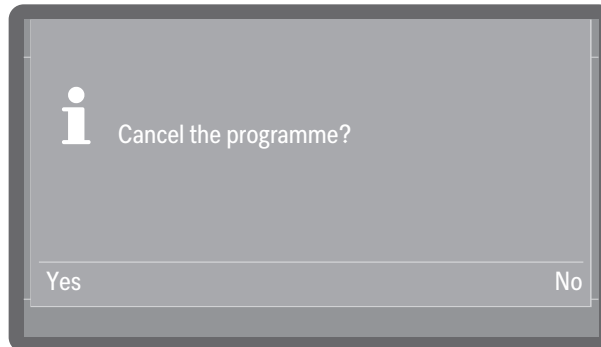
The following will appear on the display:



- Select Yes to cancel the programme.

**Tip:** A PIN code may still need to be entered. To enter the PIN code, see  “Entering the PIN code”. To set up the PIN code lock, see  Extended settings ▶ Programme options ▶ Door lock code.

The programme will only be cancelled when Yes is confirmed. If no button is pressed for several seconds, or if the process is cancelled using the  sensor control, the display will revert to the programme sequence display.

The following message will appear on the display:

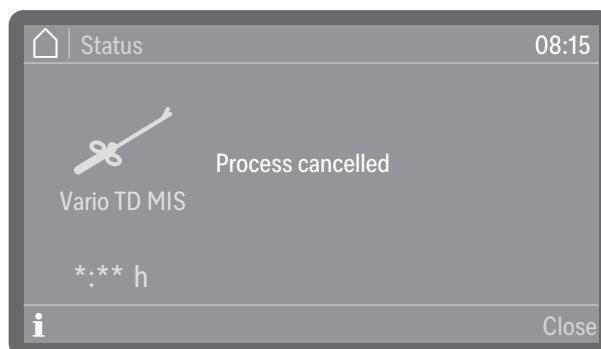

The door must be opened to acknowledge the message. Open the door a little.

### Restarting a programme

- Restart the programme or select a new programme.

## Menu structure

The  Machine functions menu includes relevant functions to support daily routine tasks.

The factory settings are indicated by a tick ✓. A description of how to configure settings is provided after the overview.

### Machine functions

---

Filter interval

---

Tubular filter \*)

---

Filter combination \*)

---

Dispensing paths

---

Fill dispensing paths

---

Rinse dispensing paths

---

AutoClose

---

Off

---

On ✓

---

Documentation

---

Last report

---

Selected reports

---

---

\*) Visible if the interval is activated, see ▶  Extended settings ▶ Maintenance/Service ▶ Filter maintenance.

### Filter interval

The machine is equipped with several filters and a filter system, subsequently referred to as filters, which require regular maintenance. Reusable filters must be cleaned and disposable filters replaced.

For more information on cleaning or replacing the filters, see  “Maintenance”. Reusable filters used in load carriers have their own operating instructions and cleaning instructions.

You can use the following menu to display the remaining time left or cycles of the filters and reset the counter after a filter has been changed or cleaned.

The menu is saved under the following input path.

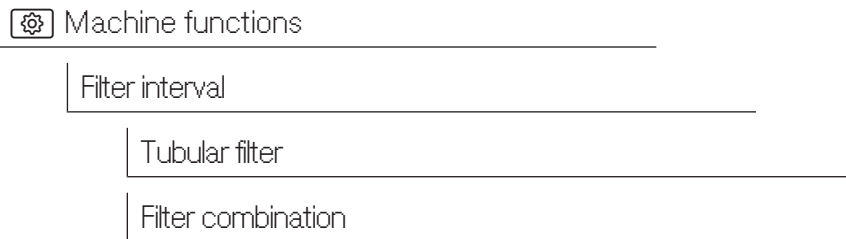

#### ■ Select a filter.

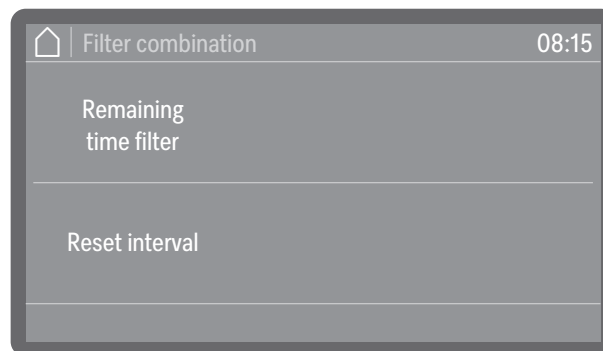

- Remaining filter cycles or Remaining time filter (depending on the type of filter selected)

Displays the remaining programme sequences (cycles) or operating hours until the next maintenance (cleaning or replacement)

- Reset interval

Resets the counters for the filter cycles

 The intervals must only be reset once the filters have been cleaned or replaced.

#### ■ Select an option.

## Dispensing paths

The dispensing systems for liquid media can only dispense reliably if the dispensing system has been purged of air and contains no deposits.

### Filling dispensing paths

The dispensing systems need to be topped up in the following situations:

- If the dispensing system is being used for the first time.
- If air has been sucked in or the system has been drained.
- If canisters for liquid media have been changed or refilled.

Before filling the dispensing paths, make sure that the canisters are full and that the suction lances are screwed securely to the canisters and that they cannot suck in air.

The menu is saved under the following input path.

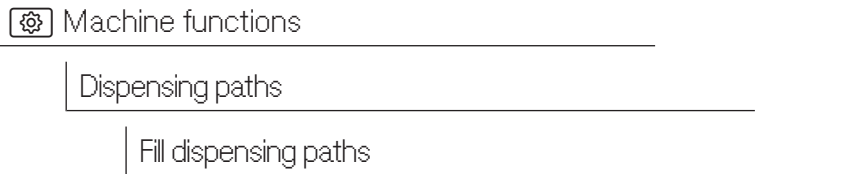

- Select the Fill dispensing paths menu option.
- Select the dispensing system that you want to fill.

You will then be asked if you want to start the filling process:

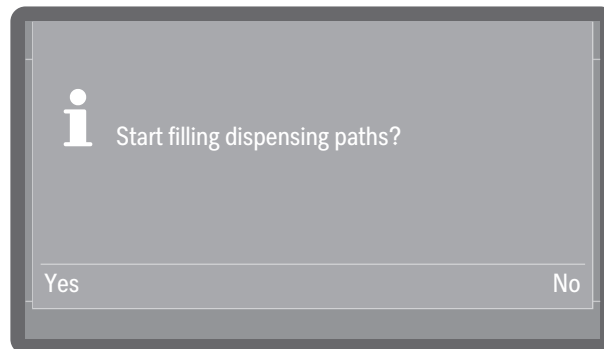

- Yes

Starts the process. The dispensing system is filled automatically. The message Filling of dispensing paths completed is displayed following successful completion. If filling is interrupted prematurely, the process must be repeated.

- No

Cancels the process without filling the dispensing system.

- Select an option.

## Machine functions

### Rinsing dispensing paths

A dispensing system must be rinsed in the following situations:

- If a dispensing system was accidentally filled with the wrong medium.
- If deposits have formed in the dispensing paths or in the canisters which could completely or partially clog the systems. Deposits can form, for example, after long periods of downtime or when the canisters are refilled instead of being replaced.
- Fill a clean container, e.g. a bucket, with clean water.

 **Damage to the dispensing system.**  
Small foreign objects in the water, such as sand, fluff or similar, can be sucked in by the dispensing system and may clog or damage it. Make sure that there are no foreign objects in the water.

The menu is saved under the following input path.

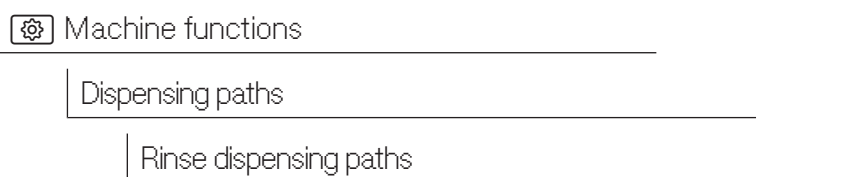

- Select the Rinse dispensing paths menu option.
- Select the dispensing system that you want to rinse.

The message Place the suction lance in a bucket with water. is then displayed.

- Place the suction lance in the container with water. The lower end of the suction lance with the suction opening must be thoroughly rinsed.
- Secure the suction lance so that it cannot tip over or fall out of the container.
- Press **OK** to confirm the message.

You will then be asked if you want to start the process:

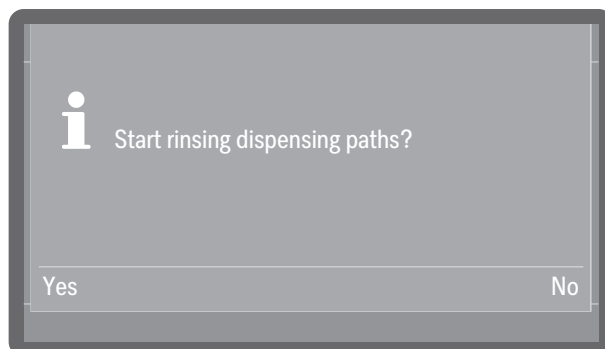

- Yes  
Starts the process. The dispensing system is rinsed automatically. The message Rinsing of dispensing paths completed is displayed following successful completion. If rinsing is interrupted prematurely, the process must be repeated.
- No  
Cancels the process without rinsing the dispensing system.

- Select an option.

### AutoClose

This can be used to determine whether the door should be drawn into the final closed position by the automatic door lock immediately after closing or whether it should remain slightly open.

In its final closed position, the door is mechanically locked and can be unlocked and opened again by pressing the door button .

The menu is saved under the following input path.



- Select the AutoClose menu option.

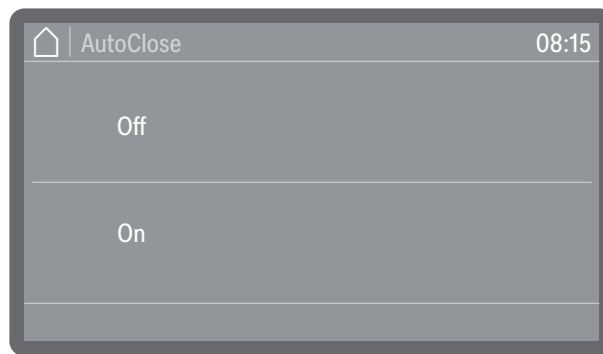

- On

AutoClose is activated for all programmes. The door is drawn into the final closed position and locked immediately after closing.

- Off

AutoClose is deactivated for all programmes. The door hooks into the latch and can be pulled open again without pressing the  sensor control.

- Select an option.

### Documentation

Internally stored protocols can be output retrospectively from the machine. To do this, the machine must be connected to a network or to a printer, see ► WiFi / LAN.

The menu is saved under the following input path.

 Machine functions

---

Documentation

---

- Select the Documentation menu option.

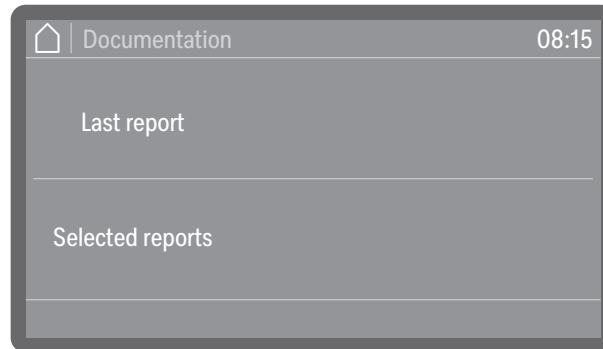

- Last report

The last cycle protocol is output again.

- Selected reports

You can select individual protocols from the last protocols and have them displayed.

- Select an option.

## Menu structure

Basic parameters for machine control are stored in the  Settings menu.

The factory settings are indicated by a tick ✓. A description of how to configure settings is provided after the overview.

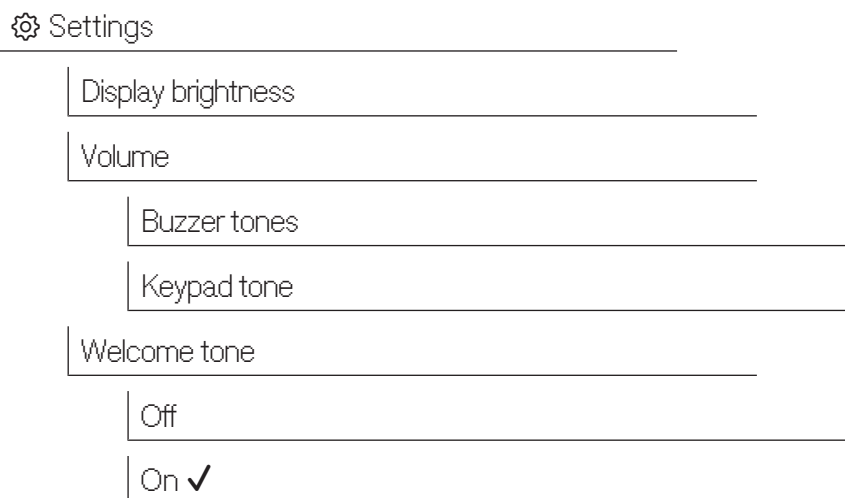

## Display brightness

You can also set the brightness of the display.

The menu is saved under the following input path.



- Select the Display brightness menu option.



- Adjust the brightness of the display and press *OK* to save the setting.

## Volume

An acoustic signal transmitter is integrated in the control panel, which can provide acoustic feedback in the following situations:

- Keypad tone when operating the buttons
- Buzzer tones at the end of a programme or for system messages (notifications)

The menu is saved under the following input path.

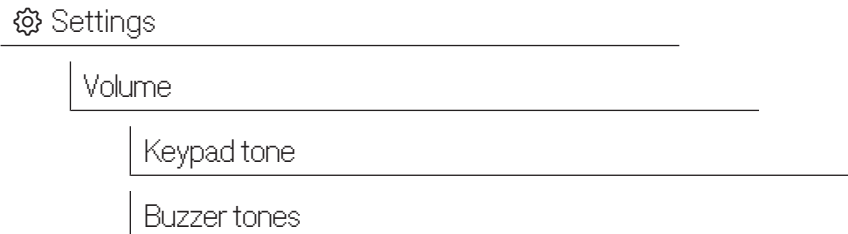

- Select the **Volume** menu option.
- Select either **Keypad tone** or **Buzzer tones**. The volume is set in the same way for both options.

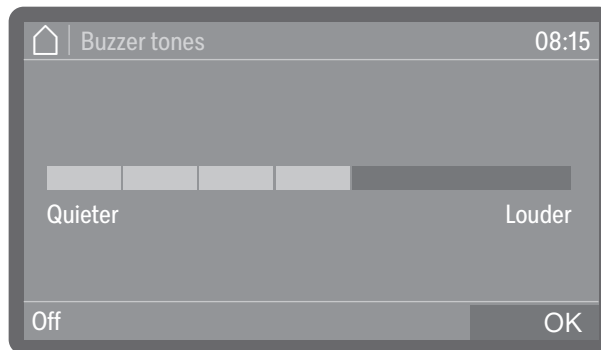

- Set the volume.  
If you select **Off**, the sound can be switched off entirely. You can switch it on again if required by selecting **On** (displayed instead of **Off**).
- Press **OK** to save the setting.

## Welcome tone

There is a brief melody when the machine is switched on and off. You can use this option to switch this melody off and back on again.

The menu is saved under the following input path.

 Settings

Welcome tone

- Select the Welcome tone menu option.

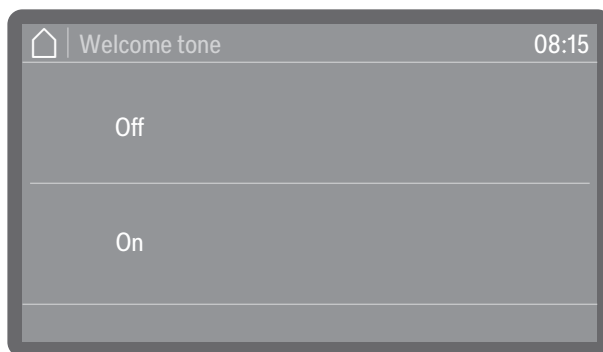

- Off

The melody is switched off.

- On

A welcome melody is played when the machine is switched on.

- Select an option.

## Process documentation

---

### Logging process data

Processes are documented per cycle. Setpoint and actual values are always recorded.

During the programme cycles, the following data is logged, among other things:

- Machine model and serial number
- Date
- Programme
- Start time
- Cycle number
- Wash blocks
- Dispensing system with dispensing temperature and target dispensing amount if necessary
- Setpoints for temperature and holding time
- Minimum and maximum temperatures during the holding time
- Wash pressure measuring results
- Fault messages
- Programme finish time
- System messages, e.g. salt refill

### Memory

Up to 20 cycle protocols are stored in an internal power failure safe memory within the machine. In the event of network or printer problems, for example, these can be subsequently recalled. If the memory is full, the oldest protocol is overwritten.

In addition, raw data from the last programme cycle is stored to create a graphical display of the process data. This data can be converted into graphical representations using external apps or other documentation software systems. It is not possible to create graphical representations in the display or on a directly connected printer. Power failure safe storage of graphical information is not available.

### Adding cycle numbers

Miele Customer Service can add subsequent cycle numbers, e.g. in the event of software updates or if the machine controls are replaced.

### Communication modules

The machine is equipped with an integrated WiFi module. In addition, the machine has a module slot on the back of the machine, which can be equipped with a Miele XKM communication module to set up wired interfaces.

The interface can be used to permanently archive cycle protocols using documentation software, apps or a report printer. In addition, further digital offers are available if you are connected to the Miele cloud.

Please contact Miele for further information on software, the Miele cloud and suitable printers.

Only use terminal devices (PC, printers, etc.) compliant with IEC/EN 62368 (Australia and New Zealand: AS/NZS 62368).

Depending on the equipment variant, the machine is either equipped with a communication module at the factory or a module can be retrofitted at any time. The communication modules are available from Miele as an accessory. The modules have their own instructions.

Only specialists are permitted to configure the interface, see ▶  Extended settings ▶ Networking ▶ WiFi / LAN.

### Periodic checks

The machine should be serviced **every 2000 hours of operation, or at least once every 12 months**, by Miele Customer Service or a suitably qualified specialist.

If the machine is used exclusively for reprocessing dental, podiatry or veterinary load items or ward utensils, the service interval can be extended to up to months (or 2000 operating hours). The service interval is set by Miele Customer Service or by a suitably qualified specialist and adjusted if necessary.

Maintenance covers the following points and functional checks:

- Replacement of wear parts
- Electrical safety check compliant with national rules and regulations (e.g. VDE 0701, VDE 0702 in Germany)
- Door mechanism and door seal
- Any screw connections and connectors inside the wash cabinet
- Water inlet and drainage
- Internal dispensing systems
- Spray arms
- Filter combination
- Sump including drain pump and non-return valve
- All load carriers
- Steam condenser
- Wash mechanism/wash pressure
- Visual inspection and functional check of components
- A thermo-electric check
- Seals will be tested for water tightness
- Safety testing of all relevant measuring systems
- Safety features

External documentation software and the computer network will not be tested by Miele Customer Service.

### Routine checks

Before the start of each working day, the operator must carry out a number of routine checks.

The following need to be checked:

- Filters in wash cabinet
- Machine spray arms
- Wash cabinet and door seal
- Dispensing systems
- Water connection closing flaps in the rear panel of the wash cabinet
- Load carriers, e.g. baskets, modules and inserts, as well as any irrigation connectors that may be present
- Filters in load carriers

### Cleaning the filters in the wash cabinet

 Risk of damage due to blocked waterways.

If the filters are not inserted, dirt particles will end up in the machine water circuit. The dirt particles may block the nozzles and valves.

Only start a programme if the filters are inserted.

Check that the filters are positioned correctly when you reinsert them after cleaning.

The filters in the floor of the wash cabinet prevent coarse soiling from coming into contact with the circulation system. Filters can become blocked by soiling. They therefore need to be checked every day and cleaned as necessary.

It is possible to set a cleaning interval for the filters in the wash cabinet in the controls, see  Extended settings ▶ Filter maintenance.

The cleaning interval is not a substitute for the daily routine check of the filters in the wash cabinet.

# Maintenance

## Removing and cleaning filters

⚠ Danger of injury from sharp and pointed objects.  
There is a danger of injury from sharp or pointed objects (e.g. glass shards or needles) retained in the filters. Small glass shards in particular are not always immediately visible in the filter.  
Therefore, take extra care when removing and cleaning the filters.

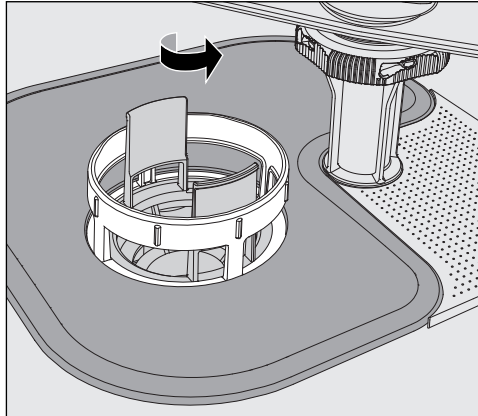

- Loosen the microfine filter by turning it in the direction of the arrow and remove it together with the coarse filter.

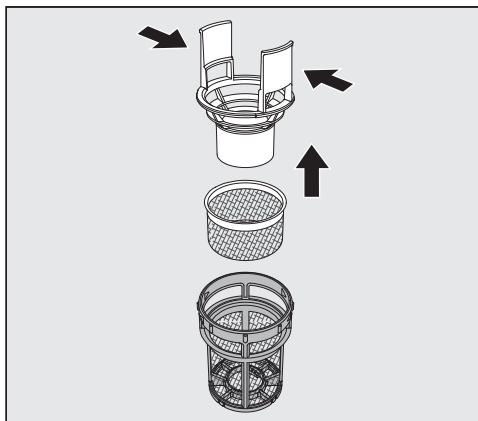

- Press the catches together and pull the coarse filter up and out to remove it.
- Remove the fine filter which sits loosely between the coarse filter and the microfine filter.

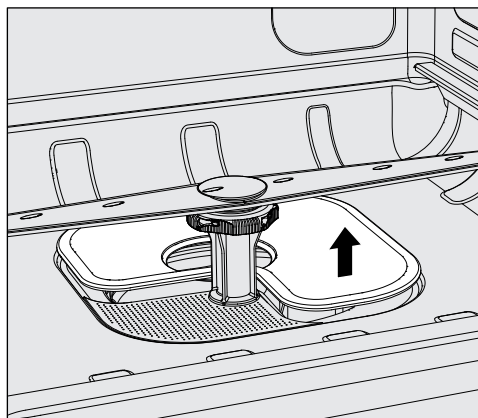

- Remove the surface filter last.
- Clean the filters.

- Refit the filter combination in reverse order.
  - Ensure that the surface filter sits flat in the base of the wash cabinet.
  - The coarse filter must securely click into place in the microfine filter.
  - The microfine filter is screwed in tight as far as it will go.

### Cleaning the spray arms

The spray arm nozzles can become blocked, especially if the filters are not inserted correctly in the wash cabinet. This can cause coarse particles of soiling to get into the wash water circulation.

The spray arms must be visually checked daily for any soiling.

- To do this remove the mobile unit or the baskets.
- Visually check the spray arms for soiling and blocked nozzles.
- Also check that the spray arms can turn easily.

⚠ Immobile or blocked spray arms must not be used again.  
In this case, contact Miele Customer Service.

### Cleaning the spray arms

The spray arms must be dismantled as follows for cleaning:

- Remove the load carrier from the machine.

The upper machine spray arm is attached with a plug connection.

- Pull the upper machine spray arm downwards.

The bottom machine spray arm is secured with a bayonet fitting.

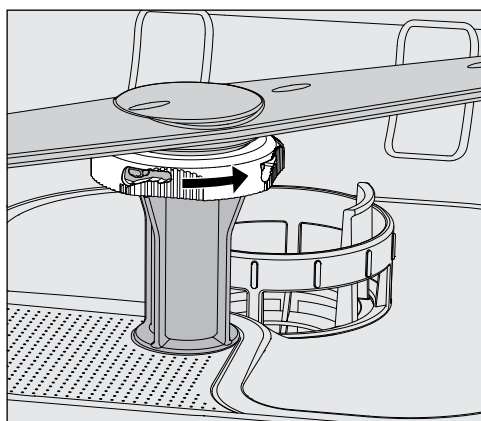

- Loosen the knurled bayonet catch by turning it as far as it will go in the direction of the arrow.
- You can then pull the spray arms up.

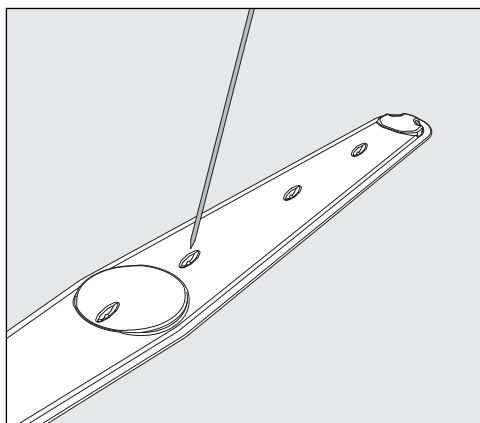

- Use a pointed object to push particles into the spray arm.
- Rinse the spray arm thoroughly under running water.

⚠ Do not allow any magnetic objects or load items to attach to the magnets on the spray arms.

Any metallic objects on the magnets can cause a false reading of spray arm rotation.

Remove all metal objects from the magnets.

- Check the spray arm bearings for visible signs of wear.

Visible wear on the bearings can adversely affect the long-term functioning of the spray arms.

In this case, contact Miele Customer Service.

- Replace the spray arms after cleaning.
- Make sure the spray arms can rotate easily after they have been fitted.

## Cleaning the machine

⚠ Never clean the machine or near vicinity with a water hose or a pressure washer.

⚠ Do not use cleaning agents containing ammonia or thinners on stainless steel surfaces!

These agents can damage the surface material.

For surface disinfection, use a cleaning agent recommended and listed by the manufacturer, e.g. an alcohol-based agent with a maximum alcohol content of 70 %.

### Cleaning the control panel

⚠ Do not use abrasive cleaners or all-purpose cleaners to clean the control panel.

Due to their chemical composition, these can cause considerable damage to the glass and plastic surfaces and to the onset control buttons.

- Clean the control panel with a damp cloth and washing-up liquid or with a non-abrasive stainless steel cleaner.
- You can also use commercially available glass or plastic cleaners to clean the display and the plastic underside.

### Cleaning the door and the door seal

- Wipe the door seals regularly with a damp cleaning cloth to remove any soiling.  
Door seals which are no longer tight or which have suffered damage must be replaced with new ones by Miele Customer Service.
- Remove any soiling from the door sides and hinges.
- Regularly clean the groove in the plinth panel under the door with a damp cleaning cloth.

### Cleaning the wash cabinet

The wash cabinet is generally self-cleaning. However, should a build-up of deposits occur in the cabinet, please contact Miele Customer Service for advice.

### Cleaning the machine front

- Clean the stainless steel surface with a damp cleaning cloth and washing-up liquid or a non-abrasive stainless steel cleaning agent.

### Preventing re-soiling

- To help prevent re-soiling of stainless steel surfaces (fingerprints, etc.), a suitable stainless steel care product can be used after cleaning.

### Checking the load carriers

Load carriers must be checked daily to make sure they are functioning correctly.

The following points need to be checked:

- If the load carriers have rollers, are the rollers in good condition and are they securely attached to the load carrier?
- Are the water connectors present and undamaged?
- Are height-adjustable water connectors adjusted to the correct height and securely fixed?
- Are all nozzles, irrigation sleeves and hose adapters securely attached to the load carrier?
- Are all nozzles, irrigation sleeves and hose adapters clear so that wash water can flow through unhindered?
- Are all caps and fasteners securely attached to the irrigation sleeves?
- Are end caps present and securely positioned for all modules and injector manifolds?
- Are the caps in the water connectors of load carriers working properly?

## Process validation

The standard of cleaning and disinfection in the disinfection programmes must be confirmed by the operator as a routine matter.

Safety checks and performance validation must be carried out in accordance with the internationally recognised standard EN ISO 15883. In some countries, national regulations, guidelines and recommendations also apply.

### Sensor test point

The sensor test point for validation is located at the front right on the top of the machine, covered by the lid or the worktop. To reach the access point, the lid of the machine must be removed or the machine must be pulled out from under the worktop.

- Open the door.

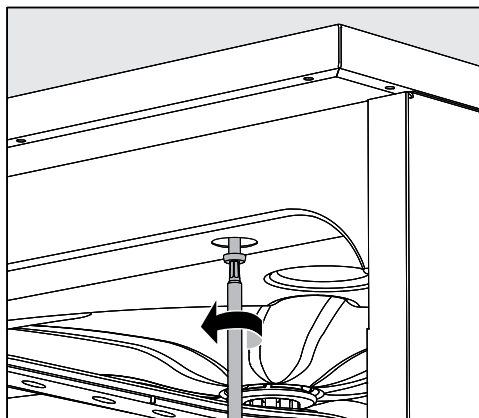

- Remove the protective caps and unscrew the fixing screws.

- Then remove the locking screws on the back of the machine from the **lid** and lift the **lid** to remove it.

Or

- Pull the machine out by approx. 15 cm from under the **worktop** until the sensor test point on the top is freely accessible.

### Test programmes

Various test programmes are available for monitoring cleaning performance in routine checks. The test programmes are not separate reprocessing programmes. Rather, they are additional functions that can be activated prior to starting any reprocessing programme.

The test programmes interrupt the programme cycle automatically at specified points. The interruption is indicated by a buzzer and message on the display. Miele Customer Service can set the duration of the interruption to between 10 seconds and approx. 42 minutes. During this time period, measurements can be made or the door can be opened to obtain a sample.

To prevent cooling of the wash cabinet, do not keep the door open too long.

The programme cycle continues automatically after the time has elapsed. If the door has been opened, the programme cannot resume until the door has been closed again.

If a measurement or sample is not needed, you can resume the programme sooner by pressing the *Start/Stop* sensor control.

The following test programmes can be selected:

## Maintenance

---

- Laboratory

The programme cycle is stopped in each wash block immediately before the wash water is drained away.

- Validation

The programme cycle is interrupted at the following points:

- Before the wash water is drained away in the final wash block
- After the interim rinse before the wash water is drained away, and
- After water intake and before draining in the final rinse block

### Activating the test programme

Test programmes are only valid for one programme cycle. To carry further tests, a test programme must be selected again beforehand in each time.

The menu is saved under the following input path.

⚙️ Extended settings

Programme options

Test programme

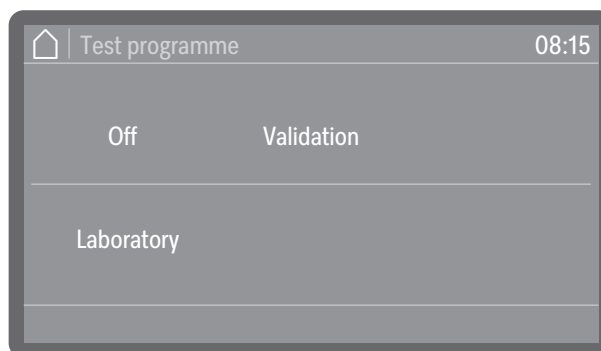

- Off

The menu is closed without a programme being selected.

- Laboratory

Activates the Laboratory test programme.

- Validation

Activates the Validation test programme.

- Select an option.

You can now start the performance test.

- To do this, select a programme from the programme list and start it.

During the programme sequence, the information Test programme is shown on the display.

If you want to deactivate the test programme again before the performance test, you have to call up the menu again and select the Off option.



If you interrupt or cancel the running programme during a performance test before an automatic measuring point has been reached, the test programme is deactivated immediately.

The following guide should help you to find the reason for a fault and to correct it. However, please observe the following:

 Danger due to unauthorised repairs.  
 Unauthorised repairs can expose the user to considerable risk.  
 Repairs may only be carried out by Miele Customer Service or a suitably qualified specialist.

To avoid unnecessary customer service visits, check that the fault has not been caused by incorrect operation when a fault message first appears.

## Technical faults and unexpected behaviour

Problem	Cause and remedy
<b>The display is dark and all backlit sensor controls are out.</b>	The machine is not switched on. ■ Switch the machine on using the  On/Off sensor control.
	A fuse is defective or has tripped. ■ Refer to the minimum fuse rating on the data plate. ■ Reset the trip switch. ■ If the fuse trips again, contact Miele Customer Service.
	The machine is not plugged in or connected to the power supply. ■ Insert the plug and switch on at the socket.
<b>The display is dark and the <i>Start/Stop</i> sensor control is pulsing.</b>	This is not a fault! The machine is ready for use. ■ Press the <i>Start/Stop</i> sensor control to reactivate the machine.
<b>The machine has switched itself off.</b>	This is not a fault! The Standby/Off function switches the machine off automatically after a preset waiting time to save energy. ■ Switch the machine on using the  On/Off sensor control.
<b>Power cut during operation</b>	If a temporary power cut occurs during a programme sequence, the programme is cancelled.
	 Risk of infection due to contaminated load items. In the event of a power cut in an early programme phase, the load items may be contaminated with soiling. Reprocess the load items after every power cut. When opening the door after a power cut, take all necessary measures to protect personnel, e.g. wear protective gloves.
<b>A programme has ended, but the machine has not rinsed.</b>	This is not a fault. The demo mode for simulating processes and programme sequences on the display is activated. ■ Deactivate demo mode, see ► Demo mode.

# Troubleshooting

## Maintenance and testing

Problem	Cause and remedy
Next electrical safety test due on: or in hours	This is not a fault! The Miele Customer Service has provided a recommended date for the next electrical safety test. <ul style="list-style-type: none"> <li>■ Arrange an appointment with Miele Customer Service or have the electrical safety test carried out by a suitably qualified specialist.</li> </ul>
Next validation due on: or in hours	This is not a fault! Miele Customer Service has recommended a date for the next validation. <ul style="list-style-type: none"> <li>■ Arrange an appointment with Miele Customer Service or have the validation carried out by a suitably qualified specialist.</li> </ul>
Next service due on: or in hours	This is not a fault! Miele Customer Service has recommended a date for the next service visit. <ul style="list-style-type: none"> <li>■ Arrange an appointment with Miele Customer Service or have the service carried out by a suitably qualified specialist.</li> </ul>

## Dispensing/Dispensing systems

 Caution when handling chemical agents.  
For all chemical agents, the chemical agent manufacturer's safety instructions as given on their safety data sheets must be observed.



Problem	Cause and remedy
Change canister	During a programme sequence, a low fill level was measured in a canister for liquid process chemicals. <ul style="list-style-type: none"> <li>■ Replace the empty canister with a full one.</li> </ul>
Fill dispensing paths	This is not a fault! A dispensing system is currently being filled automatically Wait until the process is complete.
Filling of dispensing paths cancelled	Filling of the dispensing system was cancelled because an insufficient flow rate was identified. A dispensing hose may be kinked or the suction lance blocked. <ul style="list-style-type: none"> <li>■ Check the dispensing hose for kinks and leaks. Position it so that it cannot become kinked.</li> <li>■ Check the suction aperture of the suction lance for blockages and remove these as necessary.</li> <li>■ Start the process again.</li> </ul> <p>Contact Miele Customer Service if there are leaks in the dispensing hose or there is a fault with the suction lance.</p>

Highly viscous (thick) process chemicals can affect the dispenser monitoring and lead to inaccurate data. In this instance, please contact Miele Customer Service for advice.

## Insufficient salt/Water softener

Problem	Cause and remedy
Refill salt - machine will be disabled shortly.	The salt supply in the water softener has been used up. Re-activation is no longer possible. The machine will be locked for further use with the next reactivation. <ul style="list-style-type: none"> <li>■ Refill with reactivation salt.</li> </ul>
F561 Machine locked, insufficient salt: refill dishwasher salt. Machine will unlock after a few seconds. Then start the "Cold water rinse" programme.	The water softener cannot reactivate because there is insufficient salt. The machine is locked for further use. <ul style="list-style-type: none"> <li>■ Refill with reactivation salt.</li> </ul> <p>The machine is unlocked a short while after the salt container has been refilled. Reactivation will occur automatically during the next programme sequence.</p>
Close salt container lid.	The salt container is not closed properly. Salt residues are preventing it from closing. <ul style="list-style-type: none"> <li>■ Remove all salt residues from the edge of the salt refilling opening, the lid and the seal. Do <b>not</b> use running water to rinse away salt residues as this can cause the container to overflow.</li> <li>■ Close the container properly.</li> </ul>

## Filters



Problem	Cause and remedy
Clean filter combination. Then reset filter interval (see machine functions).	The filter combination needs cleaning. <ul style="list-style-type: none"> <li>■ Remove the filter combination and clean it, see  "Cleaning the filters in the wash cabinet".</li> <li>■ After cleaning, reset the maintenance interval for the filter combination, see ▶  Machine functions ▶ Filter interval ▶ Filter combination ▶ Reset interval.</li> </ul>
Clean tubular filter. Remaining cycles:	The tubular filters in the load carriers need cleaning. <ul style="list-style-type: none"> <li>■ Remove the tubular filters and clean them. To do this, follow the instructions in the operating instructions for the tubular filters.</li> <li>■ After cleaning, reset the maintenance interval for the tubular filters, see ▶  Machine functions ▶ Filter interval ▶ Tubular filter ▶ Reset interval.</li> </ul>

# Troubleshooting

## Cancellation with fault number

If a programme is cancelled and a fault number appears, e.g. Fxxx (where xxx represents a number), there could be a serious technical fault.

In the event of a programme being cancelled and a fault number being shown:

- Follow the instructions in the display.
- Switch the machine off using the  On/Off sensor control.
- Wait approximately 10 seconds before switching the machine on again with the  On/Off sensor control.
- Start the previously selected programme again.

If the same fault message appears again:



- Make a note of the fault message.
- Switch the machine off using the  On/Off sensor control.
- Contact Miele Customer Service.

Please also read the notes regarding the following fault numbers:

Problem	Cause and remedy
F433, F438 <b>Door blockage</b>	Objects in the closing area of the door or outside in front of the door prevent the door from being opened or closed automatically. <ul style="list-style-type: none"><li>■ Remove all objects in front of the door of the machine, e.g. mobile units or boxes.</li><li>■ Open the door and remove all objects that protrude into the closing area of the door. For example, sort the load items so that they do not protrude into the door area and remove all objects that protrude into the door area from the outside, e.g. hanging cleaning cloths.</li><li>■ Switch the machine off and then back on again.</li></ul>
F434, F444, F446 <b>Door lock</b>	Slamming the door can result in problems with the Comfort door lock. <ul style="list-style-type: none"><li>■ Open and close the door.</li></ul>
F460, F461, F462 <b>Spray arm blockage</b>	The set speed has not been reached. <ul style="list-style-type: none"><li>– Load items are blocking the spray arm<ul style="list-style-type: none"><li>■ Arrange the load items so that the spray arms can turn easily and start the programme again.</li></ul></li></ul>
	– The spray arm is clogged <ul style="list-style-type: none"><li>■ Clean the spray arm.</li><li>■ Check whether the filters in the wash cabinet are clean and correctly inserted.</li><li>■ Start the programme again.</li></ul>
	– Wash pressure is too low due to a heavy build-up of foam <ul style="list-style-type: none"><li>■ Follow the instructions regarding foam build-up, see  “Chemical processes and technology”.</li><li>■ Start the Cold water rinsing programme in order to clean the wash cabinet.</li><li>■ Then reprocess the load items again.</li></ul>

Problem	Cause and remedy
F511, F512, F513 <b>Dispensing pump</b>	Technical defect in one of the dispensing pumps. ■ Contact Miele Customer Service.
F518, F519, F520 <b>Dispensing system</b>	<p>Fault detected in the dispensing system.</p> <div style="border: 1px solid gray; padding: 5px;"> <p> Take care when using process chemicals. For all process chemicals, the manufacturer's safety notes as given on their safety data sheets must be observed.</p> </div> <ul style="list-style-type: none"> <li>■ Check the fill levels of the canisters and replace empty ones with full ones.</li> <li>■ Check the suction apertures of the suction lances and remove any deposits.</li> <li>■ Check the connections between the dispensing hoses and the suction lances, the machine, etc.</li> <li>■ Remove any kinks from the dispensing hoses and check the hoses for leaks. Position the dispensing hoses so that they cannot kink.</li> <li>■ Vent the dispensing systems.</li> </ul> <p>If you identify any leaks in the dispensing hoses or defects on the suction lances, contact the Miele Customer Service Department.</p>

## Door

Problem	Cause and remedy
Hot wash cabinet: Risk of injury, take care when opening the door.	<p>When the  door sensor control is pressed, the temperature in the wash cabinet is over 60 °C.</p> <div style="border: 1px solid gray; padding: 5px;"> <p> When the door is opened, hot steam and process chemicals can escape.</p> </div> <ul style="list-style-type: none"> <li>■ Open the door only when strictly necessary.</li> </ul>
Anti-trap guard: To continue, open the door.	<p>The door was closed before the door lock catch was fully retracted.</p> <ul style="list-style-type: none"> <li>■ Open the door.</li> <li>■ The door lock catch must be fully retracted before you close the door again.</li> </ul>
Emergency release: To continue, open the door.	<p>The door was opened using the emergency release.</p> <ul style="list-style-type: none"> <li>■ Follow the instructions for emergency release, see  "Opening the door using the emergency release".</li> </ul>

# Troubleshooting

## Unsatisfactory cleaning and corrosion

Problem	Cause and remedy
<b>White deposits remain on the load items.</b>	The water softener settings are too low. ■ Programme the water softener to the appropriate water hardness.
	The salt in the container has been used up. ■ Refill with reactivation salt.
	The quality of the water for the final rinse was not sufficient. ■ Use water with low conductivity. ■ If the machine is connected to a full demineralisation cartridge, check its condition and replace it if necessary.
	The water entering via the DI water connection is not sufficiently demineralised. ■ Check the upstream demineralisation systems. If necessary, the demineralisation cartridge of the water purifier must be replaced.
<b>The load items are flecked.</b>	The rinsing agent container is empty. ■ Refill the container.
	The rinsing agent concentration is set too low. ■ Contact Miele Customer Service and have the dispensing concentration reset.
<b>The cleaning results are unsatisfactory.</b>	Load carriers were not suitable for the load items. ■ Select load carriers which are suitable for the task.
	The load carriers were loaded incorrectly or overloaded. ■ Arrange the load items correctly according to the information in the operating instructions. ■ Avoid overloading the load carriers.
	The reprocessing programme was not suitable for the soiling. ■ Select a suitable programme. Or ■ Adjust the programme parameters to suit the task.
	Soiling has been left to dry on the load items for too long. ■ Soiling should not be left on the load items for more than 6 hours before machine reprocessing.
	A spray arm is blocked. ■ Ensure the spray arms are not obstructed when arranging the load items.
	The nozzles of the spray arms are clogged. ■ Check the nozzles and clean them as necessary.
	The filters in the wash cabinet are soiled or not inserted correctly.

Problem	Cause and remedy
	<ul style="list-style-type: none"> <li>■ Check the filters and clean them if necessary.</li> </ul> <p>Load carriers were not correctly mounted on the water connection.</p> <ul style="list-style-type: none"> <li>■ Check the adapter.</li> </ul>
<p><b>Items made of glass are showing signs of corrosion.</b></p>	<p>The items are not suitable for machine reprocessing.</p> <ul style="list-style-type: none"> <li>■ Only use items which are declared by their manufacturer as suitable for machine reprocessing.</li> </ul>
	<p>Neutralisation has not taken place during the programme.</p> <ul style="list-style-type: none"> <li>■ Check the level in the supply container and vent the dispensing system if necessary.</li> </ul>
	<p>The wash temperature was too high.</p> <ul style="list-style-type: none"> <li>■ Select a different programme.</li> </ul> <p>or</p> <ul style="list-style-type: none"> <li>■ Reduce the wash temperature.</li> </ul>
	<p>Cleaning agents used were too alkaline.</p> <ul style="list-style-type: none"> <li>■ Use a milder cleaning agent.</li> </ul> <p>or</p> <ul style="list-style-type: none"> <li>■ Reduce the concentration of the cleaning agent.</li> </ul>
<p><b>Stainless steel items are showing signs of corrosion.</b></p>	<p>The stainless steel is of insufficient quality for machine reprocessing.</p> <ul style="list-style-type: none"> <li>■ Only use stainless steel items made of high quality stainless steel and follow the instructions of the manufacturer regarding machine reprocessing.</li> </ul>
	<p>The chloride content in the water is too high.</p> <ul style="list-style-type: none"> <li>■ Have a water analysis check carried out. Connection to an external water processing unit and the use of demineralised water may be necessary.</li> </ul>
	<p>Neutralisation has not taken place during the programme.</p> <ul style="list-style-type: none"> <li>■ Check the level in the supply container and vent the dispensing system if necessary.</li> </ul>
	<p>Rust or superficial rust has built up in the wash cabinet, e.g. due to an excessively high iron content in the water or rust on other wash load items.</p> <ul style="list-style-type: none"> <li>■ Check the installation.</li> <li>■ Discard any rusty items.</li> </ul>

## Troubleshooting

### Spray arm monitoring/wash pressure

Problem	Cause and remedy
Upper spray arm: Blockage detected <b>or</b> Lower spray arm: Blockage detected	<p>The set speed has not been reached.</p> <ul style="list-style-type: none"> <li>– Load items are blocking the spray arm</li> <li>■ Arrange the load items so that the spray arms can turn easily and start the programme again.</li> </ul>
	<ul style="list-style-type: none"> <li>– The spray arm is clogged</li> <li>■ Clean the spray arm.</li> <li>■ Check whether the filters in the wash cabinet are clean and correctly inserted.</li> <li>■ Start the programme again.</li> </ul>
	<ul style="list-style-type: none"> <li>– Wash pressure is too low due to a heavy build-up of foam</li> <li>■ Follow the instructions regarding foam build-up, see  “Chemical processes and technology”.</li> <li>■ Start the Cold water rinsing programme in order to clean the wash cabinet.</li> <li>■ Then reprocess the load items again.</li> </ul>

### Noises

Problem	Cause and remedy
<b>Knocking noise in the wash cabinet.</b>	<p>One or more spray arms are knocking against the wash load.</p> <ul style="list-style-type: none"> <li>■ Cancel the programme. To do this follow the instructions in “Cancelling a programme”.</li> <li>■ Arrange the wash load so it cannot obstruct the spray arms.</li> <li>■ Make sure the spray arms can rotate freely.</li> <li>■ Start the programme again.</li> </ul>
<b>Rattling noise in the wash cabinet.</b>	<p>Items are insecure in the wash cabinet.</p> <ul style="list-style-type: none"> <li>■ Cancel the programme. To do this follow the instructions in “Cancelling a programme”.</li> <li>■ Rearrange the load so that items are secure.</li> <li>■ Start the programme again.</li> </ul>
<b>Knocking noises in the water supply pipe.</b>	<p>This may be caused by the on-site installation or the cross-section of the water supply pipe being too small. This does not affect the function of the machine.</p> <ul style="list-style-type: none"> <li>■ Contact a qualified installer.</li> </ul>

### Cleaning the drain pump and non-return valve

If water has not been pumped away at the end of a programme there may be a foreign object in the drain pump or blocking the non-return valve.

- Remove the filter combination from the wash cabinet, see  “Cleaning the filters in the wash cabinet”.

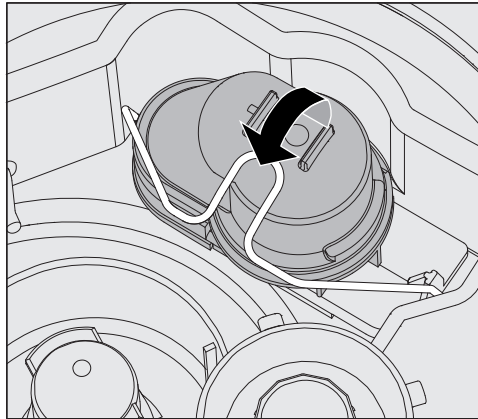

- Open the locking clamp.
- Lift out the non-return valve and rinse well under running water.
- Make sure that the vent on the outside of the non-return valve is not blocked (this vent is only visible after the non-return valve has been taken out). If it is blocked, use a pointed object to release the blockage.

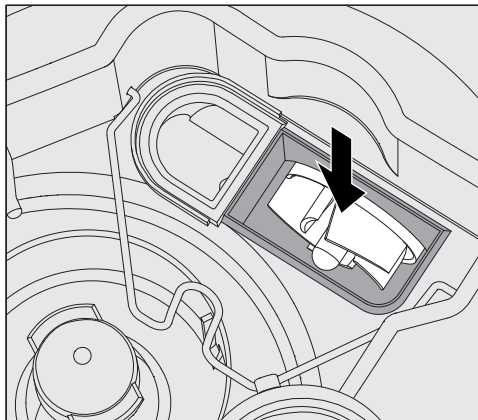

The drain pump impeller is situated under the non-return valve.

- Check the impeller for blockages and remove them if necessary before refitting the non-return valve.
- Carefully replace the non-return valve and secure it with the locking clamp.

## Problem solving guide

### Cleaning the water intake filters

Filters are incorporated into the water inlet connection on the hose to protect the water inlet valve. If these filters get dirty they must be cleaned as otherwise too little water will flow into the wash cabinet.

⚠ The plastic housing on the water inlet valve contains an electrical component. It must not be dipped in water.

#### To clean the filter

- Disconnect the machine from the mains (switch the machine off, unplug it or disconnect or disable the fuse).
- Close the stopcock.
- Unscrew the water intake valve.

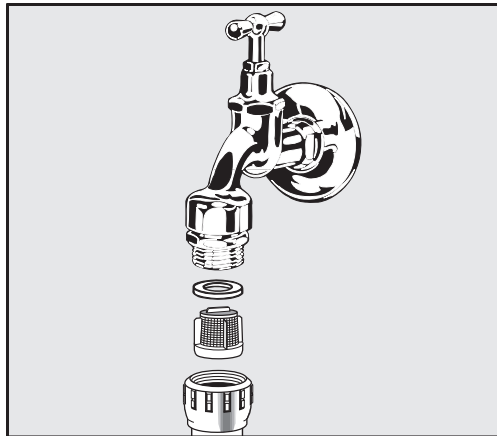

- Remove the seal from the screw thread.
- Pull the filter out using combination or pointed pliers.
- Clean the filter or replace it if necessary.
- Replace the filter and seal, making sure they are sitting correctly.
- Screw the water intake valve onto the stopcock. Ensure that the screw thread goes on straight and not cross-threaded.
- Open the stopcock. If water leaks out, the screw connection may not be connected securely or it may have been screwed on at an angle. Fit the water intake valve straight and screw it in place.

#### Retrofitting the large-surface filter

If the water contains a high level of insoluble components, a large-surface filter can be installed between the stopcock and the water inlet hose.

The large-surface filter is available from Miele Customer Service.

#### **IMPORTANT**

##### **UK, Australia and New Zealand**

For the UK, Australia and New Zealand a non-return check valve is required between the tap and optional filter.

### Contacting Customer Service

 Repairs may only be carried out by Miele Customer Service or an authorised technician.  
Unauthorised repairs can expose the user to considerable risk.

To avoid unnecessary customer service visits, you should check whether this fault can be remedied yourself using the instructions in  “Problem solving guide” the first time a fault message occurs.

If, having followed the advice in the operating instructions, you are still unable to resolve a fault, contact Customer Service.

The contact details can be found on the back of these  operating instructions or on the Miele homepage, e.g. at [www.miele.com/professional](http://www.miele.com/professional).

If possible, please have the following information ready when contacting us:

- The model and serial number of the machine

This information can be found on the data plate. The position of the data plates is described in the machine overview or can be called up via the display at ▶  Extended settings ▶ Data plate.

- The fault message and the fault number from the display
- The software versions of the machine components

This information can be found on the display at ▶  Extended settings ▶ Software version.

### Notification of serious incidents

If serious incidents occur that are related to the washer-disinfector – that is, if death or a significant deterioration in the health of a patient, user or third party results or could have resulted, this must be reported to the manufacturer and the responsible authorities in the relevant country. This also applies in the event of a serious risk to public health.

Contact details for the manufacturer can be found at the end of these operating instructions.

## Setup and alignment

Further information can be found in the installation plan. The installation plan is available online.

 Unauthorised access poses a risk.  
Settings in the machine, e.g. parameters for dispensing process chemicals, may be changed as a result of unauthorised access via the machine display.  
Set up the machine in a room with restricted access. Only give the PIN code to people you trust.

 Risk of injury from metal parts.  
With some metal parts, there is a risk that you may be injured or cut.  
Wear cut-resistant protective gloves when transporting and setting up the machine.

 Risk of injury when lifting the machine.  
Due to their heavy weight, the machines must not be lifted by a single person.  
If possible, always have 2 or more people lift the machines. Follow the instructions on occupational safety, e.g. ensure an ergonomic posture when lifting.  
Use suitable aids such as pallet trucks or sack trucks for longer transport distances.

 Material damage during transport with pallet trucks, sack trucks or other transport aids.  
Pallet trucks, sack trucks or other transport aids can dent components in the plinth of the machine and damage them.  
When transporting the machine using pallet truck, sack truck or other transport aids, the machine must be in its original packaging or placed on a stable, continuous support.  
When transporting the machine using a sack truck, do not lift it from the front as this could damage the control panel or the door.

 Material damage during transport or installation.  
Do not lift, pull or push the machine by protruding parts, such as the control panel, the open door, drawers (if present), components on the back of the machine, hoses or cables, as these could be damaged or torn off.  
To lift, pull or push the machine, hold it by the housing if possible.

## Installation variants

The machine is suitable for the following installation variants:

- Freestanding
- Slot-in:

The machine should be placed next to other machines or furniture or in a niche. The niche must be at least 600 mm wide and 598 mm deep.

- Built-under:

The machine should be placed under a continuous worktop or sink drain. The installation space must be at least 600 mm wide, 598 mm deep and 820 mm high.

Freestanding machines or machines positioned in a niche must be equipped with machine lids.

Matching lids are available from Miele.

## Levelling out uneven floors

The machine must be stable and horizontal.

Any unevenness in the floor level and height of the machine can be compensated for by adjusting the 4 feet. The feet can be screwed out to a maximum of 60 mm.

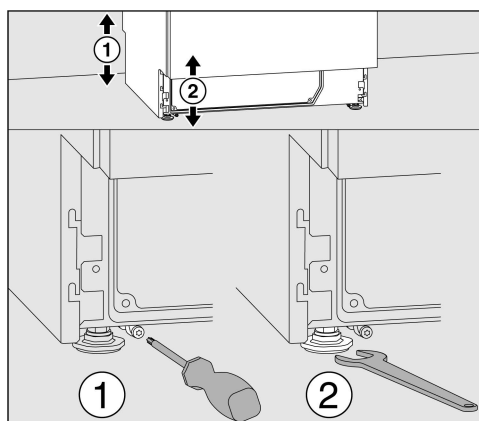

The front machine feet can be adjusted with an open spanner (spanner size 13); the rear ones with a T20 Torx screw.

If the runners of the rear machine feet are not fitted, the machine feet can also be adjusted with the open spanner.

They are adjusted upwards when turned clockwise and downwards when turned anti-clockwise.

## Hose holder

The supplied hose holders can be used to lay the power cable and the hoses for supply and waste water in a way that saves space.

The hose holder prevents hoses from kinking or crushing when installing the machine in tight recesses.

The power cable and hoses can be laid either on the left or the right, depending on the connection situation.

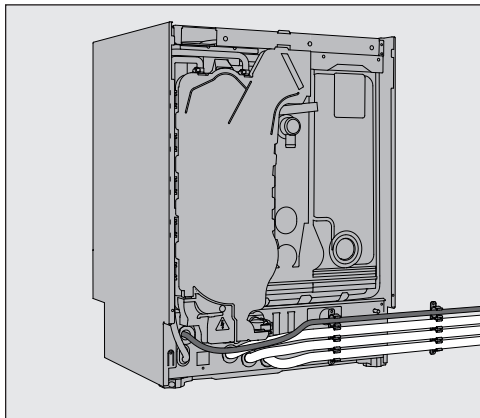

## Lids

The lids must be screwed to the machine. The side with the screw threads on the underside belongs at the front; the side with the brackets for the locking screws protruding downwards at the rear.

Installation instructions are included with lids that can be purchased separately.

- Place the lid on the machine. The lid must be flush-fit.
- Tighten the two locking screws on the back of the machine.
- Open the door.

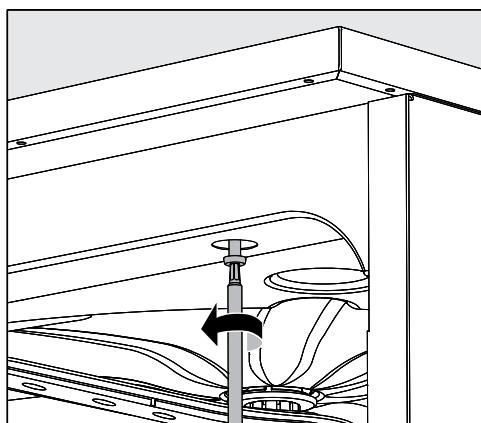

- Remove the cover caps on the left and right and tighten the fixing screws. Then refit the cover caps.

## Building under a continuous worktop

**⚠** Damage caused by condensation.  
 When the machine is in operation, vapours escape which can condense on the furniture and fittings in the immediate vicinity.  
 In order to reduce the risk of water damage, the area around the machine should be limited to furniture and fittings that are designed for use in commercial environments.

### Steam condenser

To avoid steam damage to the worktop the protective foil supplied (25 x 58 cm, self-adhesive) must be applied underneath the worktop in the area of the steam condenser.

### Securing to the worktop

To improve stability, the machine must be secured to the worktop after it has been aligned.

- Open the door.

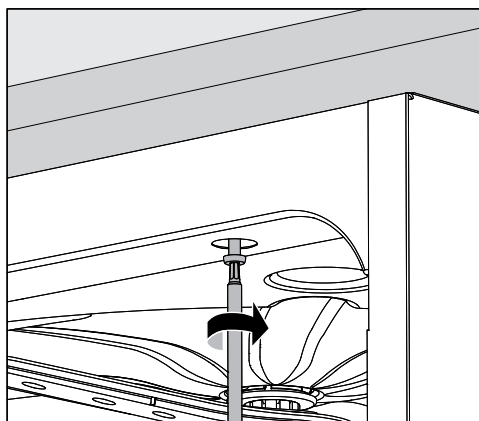

- Remove the cover caps on the left and right. Screw the machine to the continuous worktop through the holes in the front trim. Then re-fit the cover caps.

Please contact Miele Customer Service to secure it at the sides to adjacent cabinetry.

### Venting the circulation pump

**⚠** The gaps between a built-in machine and adjacent cabinetry must not be sealed, e.g. with silicone sealant, as this could compromise ventilation of the circulation pump.

### Vapour barrier for worktops

The vapour barrier supplied protects the worktop from damage caused by steam when the door is opened. It must be positioned underneath the worktop above the machine door.

### **Electromagnetic compatibility (EMC)**

The machine has been tested for electromagnetic compatibility (EMC) in accordance with EN 61236-1 class B and is suitable for operation in commercial environments, such as hospitals, medical practices and laboratories and other similar environments which are connected to the mains power supply.

The machine's high-frequency (HF) energy emissions are very low and are therefore unlikely to interfere with other electronic devices in the vicinity.

Flooring at the installation site must be wood, concrete or tiled. Synthetic flooring must be able to withstand a relative humidity level of 30 % to minimise the risk of electrostatic discharges.

The quality of the supply voltage should comply with that found in a typical commercial or hospital environment. Check that the supply voltage is within a range of +/-10 % of its nominal value.

⚠ All electrical connections must be carried out by a suitably qualified electrician in accordance with local and national safety regulations.

- The electrical installation must be carried out in accordance with IEC 60364-4-41 or the local regulations.
- The connection to the power supply must be via a suitably rated plug and socket and must comply with national regulations. The socket must be accessible after the machine has been installed. An electrical safety test must be carried out after any maintenance or repair work, for example.
- If the machine is hard-wired to the power supply or connected via a socket, a power switch with all-pole isolation must be installed. The power switch must be designed to operate at the rated current for the machine, must ensure a 3 mm gap between all open contacts and must be able to be locked in the off position. The power switch must be accessible after the machine has been installed.
- Equipotential bonding should be carried out if required.
- The rated loads are specified on the data plate and in the wiring diagram.
- For added safety, the machine should be protected by a type A residual current device with a trip current of 30 mA (DIN VDE 0664). The installation of the residual current device must be carried out on site by the operator.
- The mains connection cable may only be replaced by an original spare part from the manufacturer.

Further information on the electrical connection can be found in the installation plan. The installation plan is available online.

The machine must only be operated with the voltage, frequency and fuse rating shown on the **data plate**.

This machine **can be converted to a different type of power supply** in accordance with the conversion diagram and wiring diagram.

The **data plates** are attached to the machine. The positions are described in the machine overview.

The **wiring diagram** is available online.

### Equipotential bonding connection

There is a screw connection point marked  $\downarrow$  at the back of the machine, to which additional equipotential bonding can be connected if required.

## Connection to the water supply

 The water inside the cleaning machine is not suitable for drinking!

- The cleaning machine must be connected to the water supply in strict accordance with local regulations.
- The water used must at least comply with European or national regulations for drinking water quality. If the water supply has a high iron content, there is a danger of corrosion occurring on load items made of stainless steel and on the cleaning machine itself. If the chloride content of the water exceeds 100 mg/l, the risk of corrosion to load items made of stainless steel in the machine will be further increased.
- In certain regions (e.g. mountainous areas), the water composition may cause precipitates to form, requiring the use of softened water in the steam condenser.
- The cleaning machine complies with the applicable European standards for the protection of drinking water.  
UK, Australia and New Zealand only: To comply with water regulation requirements, this machine must be connected to the potable water supply via the non-return check valve supplied with the machine.
- The machine is equipped as standard for connection to cold water (blue marking) and hot water (red marking) up to max. 65 °C (UK: 60 °C). Connect the inlet hoses to the stopcocks for cold and hot water.
- If no hot water supply is available, the **red** coded inlet hose for the hot water connection must also be connected to the cold water supply.
- The steam condenser is supplied with water via the cold water connection.
- The **minimum flow pressure** is 100 kPa for the cold water connection, 40 kPa (UK: 200 kPa) for the hot water connection and 30 kPa (UK: 200 kPa) for the DI water connection.
- The **recommended flow pressure** is  $\geq 200$  kPa for the cold and hot water connections and  $\geq 200$  kPa for the DI water connection in order to avoid excessively long water intake times.
- The **maximum permissible static water pressure** is 1.000 kPa.
- If water pressure is not within the specified range, please contact Miele Customer Service for advice.
- Stopcocks with a  $\frac{3}{4}$  inch screw thread must be provided on site for the connection. The valves must be easily accessible to allow the water inlet to be turned off when not in use.
- The water inlet hoses are approximately 1,7 m long pressure hoses, DN 10, with  $\frac{3}{4}$  inch screw thread. The filters in the screw threads must not be removed.

## IMPORTANT

### UK, Australia and New Zealand

For the UK, Australia and New Zealand a non-return check valve is required between the tap and optional filter.

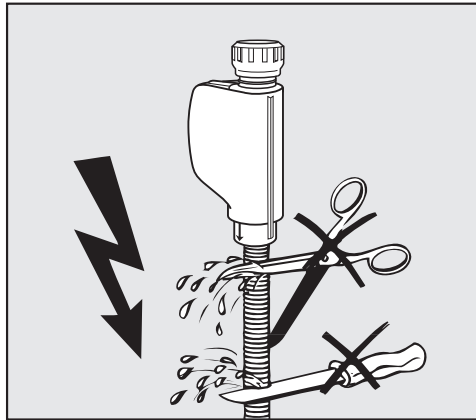

⚠ Risk of electric shock from mains voltage.

There are electrical components in the water inlet hoses.

Do not shorten or otherwise damage the water inlet hoses supplied with the machine.

Further information can be found in the installation plan. The installation plan is available online.

In line with national provisions relating to the protection of drinking water, non-return valves must be installed between the water connection and the water inlet hose on all water inlet hoses present. The connection for demineralised water is excluded.

### Retrofitting the large-surface filter

If the water contains a high level of insoluble components, a large-surface filter can be installed between the stopcock and the water inlet hose.

The large-surface filter is available from Miele Customer Service.

### DI water connection for 30-1.000 kPa (UK: 200-1.000 kPa) – pressure-proof

The machine is supplied as standard for a pressurised system operating between 30-1.000 kPa (UK: 200-1.000 kPa). At a water pressure (flow pressure) below 200 kPa, the water intake time extends automatically.

- Connect the pressure-tested, green-marked DI water inlet hose with the  $\frac{3}{4}$ " threaded union to the on-site stopcock for DI water.

⚠ If the machine is not going to be connected to demineralised (DI) water, the DI water connection has to be deactivated by Miele Customer Service. The water inlet hose remains on the back of the machine.

### Demineralised water ring line

The machine can be connected to a ring line system for demineralised water. For this purpose, the machine must be technically adapted and the controls reset by Miele Customer Service.

Please contact Miele Customer Service for further information.

## IMPORTANT

### UK, Australia and New Zealand.

The appliance must be connected to the water supply in strict accordance with local and national requirements (e.g. Plumbing Code of Australia (PCA). This appliance must be installed according to AS/NZS 3500.1 (Australia and New Zealand) or in accordance with water regulations (UK). This appliance has been supplied with a separate backflow prevention device.

This machine must be connected to the potable water supply via the non-return valve (check valve) supplied with the machine.

Before making plumbing connections, ensure the appliance is disconnected from the mains power supply (switch off or unplug from the power supply).

- Turn off the mains water tap.
- Place the seals on both sides of the non-return valve.
- Connect the female end of the non-return valve to the mains water tap (3/4" thread).
- Connect the filter (optional accessory) to the male end of the non-return valve (3/4" thread).
- Connect the inlet hose to the filter (optional accessory).

Ensure that all connections are screwed into position correctly. The connection point is subject to mains water pressure.

- Turn on the tap slowly and check for leaks.

Correct the position of the seal and union if necessary.

The demineralised water supply must meet local and national regulations and include a backflow prevention device at first point of entry.

### Connecting the drain hose

- The machine drainage system is fitted with a non-return valve, which prevents dirty water from flowing back into the machine via the drain hose.
- The machine drain hose should be connected to a separate on-site drainage system for the machine only. If a separate connection is not available, we recommend connecting the hose to a dual-chamber siphon.
- The drainage system must be able to accommodate a minimum drainage flow of 16 l/min.
- The drain hose is approx. 1,4 m long and flexible with an internal diameter of 22 mm. Hose clips for the connection are included.
- The drain hose must not be shortened.
- The drain hose can be extended using a connecting piece to attach a further length of hose up to 4,0 m. The drainage length must not be longer than 4,0 m.

Further information can be found in the installation plan. The installation plan is available online.

### Factory tests

Every Miele cleaning machine undergoes extensive quality and safety checks during the production process. They include the following specific safety checks.

#### Thermo-electric temperature checks

Thermo-electric temperature checks according to EN ISO 15883 incl. disinfection parameters are carried out at the production plant.

Thermo-electric temperature checks do not have to be carried out again during the initial commissioning of new cleaning machines.

Thermo-electric temperature checks are a mandatory requirement if disinfection parameters (e.g. temperature, holding time, AO value) are changed during initial commissioning.

Thermo-electric temperature checks must be carried out in the context of Operation Qualification (OQ) as part of performance qualification according to EN ISO 15883.

Thermo-electric temperature checks must be carried out when a machine is put back into operation after a period of downtime or having been relocated, for example.

Regional and national rules and regulations must be complied with.

#### Calibration of dispensing systems

Calibration of dispensing systems according to EN ISO 15883 is carried out at the production plant. Calibration of dispensing systems can be omitted during the initial commissioning of new cleaning machines. Calibration of dispensing systems must be carried out in the context of Operation Qualification (OQ) as part of performance qualification according to EN ISO 15883.

Calibration of dispensing systems must be carried out when a cleaning machine is put back into operation after a period of downtime or having been relocated, for example.

Regional and national rules and regulations must be complied with.

#### Electrical safety

Earthing and high-voltage testing according to IEC 61010-2-040 is carried out at the factory.

If electrical installation and/or repair work proves necessary during commissioning, an electrical safety check compliant with national rules and regulations must be carried out.





#### Wash pressure test

Testing of the wash pressure incl. spray arm speeds is carried out at the production plant in line with EN ISO 15883. Wash pressure testing does not have to be carried out again during the initial commissioning of new machines, provided that no significant changes have been made to the machine or the load carriers. Wash pressure testing must be carried out in the context of Operation Qualification (OQ) as part of performance qualification in line with EN ISO 15883. Wash pressure testing in line with EN ISO 15883 must be carried out when a cleaning machine is put back into operation after a period of downtime or after having been relocated, for example. Regional and national rules and regulations must be complied with.

## Programme chart

To adjust the programme parameters, see ▶  Extended settings ▶ Programme options  
▶ Configure programmes.



### Dental medicine

Programme	Application
 Vario TD Dental short	Cleaning and disinfection programme for dental turbines, dental handpieces and for load items with <b>light</b> , slightly dried-on soiling. <b>Not suitable for reprocessing nitrous oxide hoses.</b>
 Vario TD Dental	Cleaning and disinfection programme, compliant with EN ISO 15883, for reprocessing load items with <b>normal</b> soiling, in particular surgical instruments and instruments in tray systems. Suitable for up to 2 double hoses of nitrous oxide sedation systems.
 Vario TD Dental +	Cleaning and disinfection programme with increased wash pressure and increased water levels according to the  Vario TD Dental programme. Suitable for up to 5 double hoses of nitrous oxide sedation systems.
 Vario TD Intensive	Cleaning and disinfection programme, compliant with EN ISO 15883, for reprocessing load items with <b>heavy</b> soiling.

### Minimally invasive surgery (MIS)

Programme	Application
 Vario TD MIS	Cleaning and disinfection programme, compliant with EN ISO 15883, for reprocessing instruments from minimally invasive surgery (MIS).



### Ear, nose and throat instruments (ENT)



Programme	Application
 Vario TD ENT	Cleaning and disinfection programme, compliant with EN ISO 15883, for reprocessing ear, nose and throat instruments (ENT).
 Vario TD ENT Optic	Programme for thermal disinfection, compliant with EN ISO 15883, exclusively for reprocessing ear, nose and throat (ENT) optical instruments. <b>Manual pre-cleaning of the instruments is required.</b> Not suitable for any other ENT instruments or other medical devices.

### Gynaecology (GYN)

Programme	Application
 Vario TD GYN	Cleaning and disinfection programme, compliant with EN ISO 15883, for reprocessing gynaecological instruments (GYN).

## Additional programmes

Programme	Application
 Drain	For draining wash water, e.g. after a programme cancellation.
 Cold water rinsing	Programme for rinsing the wash cabinet, for rinsing overflowing brine after refilling reactivation salt or for rinsing heavily soiled load items, e.g. for pre-rinsing soiling, residual disinfectant or to prevent items drying out and to prevent incrustation before running a full programme. Cold water is used for rinsing, holding time: 2 min

Service programmes for Customer Service	
 Service cycle	<b>Do not use for reprocessing load items!</b> Service programme to be performed by Customer Service or a suitably qualified specialist. Special process chemicals are required for the programme.
 Refresh	<b>No cleaning programme!</b> Programme to maintain the value of stainless steel load items in use. Used to maintain and freshen up the chromium oxide passive layer and to protect against corrosion, e.g. flash rust. The programme requires a combination of special process chemicals.

## Technical data

Height With machine lid Without machine lid	835 mm (adjustable + 60 mm) 820 mm (adjustable + 60 mm)
Width	598 mm
Depth + control panel Depth with door open	598 mm + 41 mm 950 mm
Wash cabinet dimensions: Height Width Depth of lower basket	286 mm 530 mm 520 mm
Weight (net)	81 kg
Max. load capacity of open door	37 kg
Maximum load weight Lower basket	24 kg
Voltage, rated load, fuse rating	See data plate
Mains connection cable	Approx. 1,8 m
Water connection temperature: Cold water Hot water DI water	max. 20 °C max. 65 °C (UK: 60 °C) max. 65 °C (UK: 60 °C)
Static water pressure	1.000 kPa overpressure
Minimum water connection flow pressure: Cold water Hot water DI water	100 kPa 40 kPa (UK: 200 kPa) 30 kPa (UK: 200 kPa)
Recommended water connection flow pressure: Cold water Hot water DI water	≥ 200 kPa ≥ 200 kPa ≥ 200 kPa
DI water connection without pressure (optional)	8,5–60 kPa
Water inlet hose	Approx. 1,7 m
Drain hose	Approx. 1,4 m
Delivery head	Max. 1,0 m
Drainage length	Max. 4,0 m

## Technical data

Operation (according to IEC/EN 61010-1): Ambient temperature Max. relative humidity linear decrease to Min. relative humidity	5 °C to 40 °C 80 % for temperatures up to 31 °C 50 % for temperatures up to 40 °C 10 %
Storage and transportation conditions: Ambient temperature Relative humidity Air pressure	-20 °C to 60 °C 10 % to 85 % 500 hPa to 1060 hPa
Altitude above sea level (according to IEC/EN 61010-1)	Up to 2.000 m *)
Protection category (according to IEC 60529)	IP21
Degree of soiling (according to IEC/EN 61010-1)	2
Overvoltage category (according to IEC 60664)	II
Noise level in dB (A), sound pressure LpA during cleaning phases	< 70
WiFi standard	802.11 b/g/n
WiFi frequency band	2400-2483,5 MHz
Maximum WiFi transmission power	< 100 mW
VDE radio suppression, EMC equipment class (according to EN 61236-1)	B
VDE electrical safety	IEC/EN 61010-1, IEC 61010-2-040
CE marking	MDR (EU) 2017/745, Class IIb
UKCA mark (UK only)	The Supply of Machinery (Safety) Regulations 2008
Basic UDI	4002515GG05MM
SRN	DE-MF-000005768
Manufacturer address	Miele & Cie. KG, Carl-Miele-Straße 29, 33332 Gütersloh, Germany

\* If installation site is above 1.500 m, the boiling point of the wash water will be lower. In this case, the disinfection temperature and the holding time will need to be reset by Miele Customer Service.

### Disposal of the packing material

The packaging is designed to protect the machine against transportation damage. The packaging materials used are selected from materials which are environmentally friendly for disposal and should be recycled.

Recycling the packaging reduces the use of raw materials in the manufacturing process and also reduces the amount of waste in landfill sites.

### Disposing of your old appliance

Electrical and electronic appliances contain many valuable materials. They also contain certain materials, compounds and components which were essential for their correct functioning and safety. These could be hazardous to human health and to the environment if disposed of with household waste or if handled incorrectly. Please do not, therefore, dispose of your old appliance with household waste.

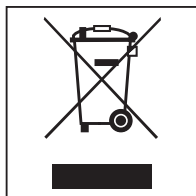

Instead, please make use of officially designated collection and disposal points to dispose of and recycle electrical and electronic appliances in your local community, with your dealer, with Miele or with the manufacturer, free of charge. By law, you are solely responsible for deleting any personal data from the old appliance prior to disposal. You are legally obliged to remove any old batteries which are not securely enclosed by the appliance and to remove any lamps without destroying them, where this is possible. These must be taken to a suitable collection point where they can be handed in free of charge. Please ensure that your old appliance poses no risk to children while being stored for disposal.

Australia and New Zealand:

Please dispose of it at your local community waste collection / recycling centre for electrical and electronic appliances. You are also responsible for deleting any personal data that may be stored on the appliance prior to disposal. Please ensure that your old appliance poses no risk to children while being stored prior to disposal.







## United Kingdom

Miele Co. Ltd., Fairacres, Marcham Road  
Abingdon, Oxon, OX14 1TW  
Professional Sales, Tel: 0845 365 6608  
E-mail: professional@miele.co.uk  
Internet: www.miele.co.uk/professional

## Australia

Miele Australia Pty. Ltd.  
ACN 005 635 398, ABN 96 005 635 398  
Level 4, 141 Camberwell Road, Hawthorn East, VIC 3123  
Tel: 1300 731 411  
Internet: www.miele.com.au/professional  
E-mail: professional.sales@miele.com.au

## China Mainland

Miele Electrical Appliances Co. Ltd.  
No. 82, Shimenyi Road, JingAn District,  
Shanghai, China, P.R.C, Post Code: 200040  
Phone: +86 21 6157 3500, Fax: +86 21 6157 3511  
E-mail: info@miele.cn, Internet: www.miele.cn

## Hong Kong, China

Miele (Hong Kong) Ltd.  
41/F - 4101, Manhattan Place  
23 Wang Tai Road, Kowloon Bay, Hong Kong  
Tel: (852) 2610 1025, Fax: (852) 3579 1404  
Email: customerservices@miele.com.hk  
Website: www.miele.hk

## India

Miele India Pvt. Ltd.  
1st Floor, Copia Corporate Suites,  
Commercial Plot 9, Mathura Road, Jasola,  
New Delhi - 110025  
E-mail: customercare@miele.in, Website: www.miele.in

## Ireland

Miele Ireland Ltd.  
2024 Bianconi Ave., Citywest Business Campus,  
Dublin 24  
Tel: (01) 461 07 10, Fax: (01) 461 07 97  
E-Mail: info@miele.ie, Internet: www.miele.ie

## Malaysia

Miele Sdn Bhd  
Suite 12-2, Level 12  
Menara Sapura Kencana Petroleum  
Solaris Dutamas No. 1, Jalan Dutamas 1  
50480 Kuala Lumpur, Malaysia  
Phone: +603-6209-0288  
Fax: +603-6205-3768

## New Zealand

Miele New Zealand Limited  
IRD 98 463 631  
8 College Hill  
Freemans Bay, Auckland 1011, NZ  
Tel: 0800 464 353  
Internet: www.miele.com.au/professional  
E-mail: professional.sales@miele.com.au

## Singapore

Miele Pte. Ltd.  
29 Media Circle, #11-04 ALICE@Mediapolis  
Singapore 138565  
Tel: +65 6735 1191, Fax: +65 6735 1161  
E-Mail: info@miele.com.sg  
Internet: www.miele.sg

## South Africa

Miele (Pty) Ltd  
63 Peter Place, Bryanston 2194  
P.O. Box 69434, Bryanston 2021  
Tel: (011) 875 9000, Fax: (011) 875 9035  
E-mail: info@miele.co.za  
Internet: www.miele.co.za

## United Arab Emirates

Miele Appliances Ltd.  
Showroom 1, Eiffel 1 Building  
Sheikh Zayed Road, Umm Al Sheif  
P.O. Box 114782 - Dubai  
Tel. +971 4 3044 999, Fax. +971 4 3418 852  
800-MIELE (64353)  
E-Mail: info@miele.ae  
Website: www.miele.ae



Manufacturer: Miele & Cie. KG, Carl-Miele-Straße 29, 33332 Gütersloh, Germany