

Operating and Installation Instructions Induction Cooktops



To prevent accidents and damage to the range, you **must** read all instructions supplied before installing or using the appliance.

Contents

IMPORTANT SAFETY INSTRUCTIONS	5
Sustainability and environmental protection	12
Installation	13
Safety distances	13
Installation dimensions	17
KM 7720 FR	17
KM 7730 FR	18
KM 7740 FR	19
Installing the cooktop	20
Preparing the countertop for installation	20
Installing the cooktop.....	20
Electrical connection	20
Overview	23
Your cooktop	23
KM 7720 FR	23
KM 7730 FR	24
KM 7740 FR	25
Controls and indicators	26
Cooking zone data.....	27
Power management system	33
Operation.....	33
Networking.....	33
Connecting to a network	33
Connection only with the ventilation hood	33
Special functions	34
Con@ctivity 3.0.....	34
Permanent pan recognition	34
Pan size recognition	34
Cooktop Booster.....	34
Auto heat-up.....	34
Timer.....	34
System lock	34
Safety lock	34
Recall	34
Keeping warm.....	34
Settings	35
Demo mode.....	35
Residual heat indicator	35
Safety shut-off.....	35
Overheating protection	36
Cooktop data.....	36
Optional accessories	36

Commissioning	37
Unpacking the cooktop.....	37
Cleaning the cooktop for the first time	37
Switching on the cooktop for the first time.....	37
Networking.....	37
Connecting to a network via WPS	37
Connecting only with a ventilation hood.....	38
Operation	39
Safety notes for operation.....	39
Switching on the cooktop	39
Switching off a cooking zone/the cooktop	39
Cooktop power levels	40
Setting the power level	40
Setting the power level – intermediate levels	40
Changing the power level	40
Booster	40
Activating the Booster function.....	40
Deactivating the Booster function	40
Activating/deactivating Stop & Go	41
Auto heat-up	41
Activating Auto heat-up	41
Deactivating Auto heat-up	42
Timer	42
Setting timer durations	42
Setting the kitchen timer	42
Changing the kitchen timer	42
Deleting the kitchen timer	42
Setting the switch-off time	42
Changing the switch-off time	42
Deleting the reduce time	43
Setting multiple reduce times.....	43
Displaying reduce times	43
Using both timer functions at the same time.....	43
System lock.....	43
Activating the system lock	43
Deactivating the system lock.....	44
Safety lock.....	44
Activating the safety lock.....	44
Deactivating the safety lock.....	44
Activating the Recall function.....	44

Contents

Cooktop data.....	44
Displaying the model number/serial number	44
Displaying the software version	44
Activating/deactivating demo mode	44
Setting ranges.....	46
Good to know.....	47
How induction cooktops work.....	47
Noises	47
Cookware.....	47
Customizing settings.....	49
Cleaning and care	52
Safety notes on cleaning and care	52
When to clean.....	52
Cleaning the glass-ceramic surfaces.....	52
Unsuitable cleaning agents.....	52
Frequently asked questions.....	54
Messages in the display	54
Unexpected behavior.....	55
Unsatisfactory results.....	56
General problems or technical faults	57
Miele Service	58
Contact in the event of a fault	58
Data plate	58
Appliance warranty and product registration	58
Ordering a printed copy of the operating instructions	58
Technical data	59
Declaration of conformity.....	59

IMPORTANT SAFETY INSTRUCTIONS

This cooktop complies with all relevant local and national safety requirements. Inappropriate use can, however, lead to personal injury and material damage.

Read the operating and installation instructions carefully before using the cooktop. They contain important information on safety, installation, use, and maintenance. This prevents both personal injury and damage to the cooktop.

In accordance with standard IEC 60335-1, Miele expressly and strongly advises that you read and follow the instructions in the chapter on installing the cooktop as well as in the “IMPORTANT SAFETY INSTRUCTIONS”.

Miele cannot be held liable for injury or damage caused by non-compliance with these instructions.

Keep these instructions in a safe place and pass them on to any future owner.

Appropriate use

- ▶ This cooktop is intended for domestic use and use in other similar environments.
- ▶ This cooktop is not intended for outdoor use.
- ▶ The cooktop is intended for domestic use only to prepare food and keep it warm. Any other use may be dangerous.
- ▶ Persons (including children) who lack physical, sensory or mental abilities, or experience with the appliance should not use it without supervision or instruction by a responsible person.

Safety with children

- ▶ Do not leave children unattended: Children should not be alone or unsupervised in the area where the appliance is installed. Do not allow them to sit or stand on the appliance.
- ▶ Children should be supervised in the vicinity of the cooktop. Never allow children to play with the cooktop.
- ▶ The cooktop gets hot when in use and remains hot for some time after being turned off. Keep children away from the appliance until it has cooled down and is no longer a burn hazard.

IMPORTANT SAFETY INSTRUCTIONS

- ▶ Danger of burning. Do not store anything which might arouse a child's interest in storage areas above or behind the cooktop. Otherwise they could be tempted to climb onto the cooktop.
- ▶ Risk of burning or scalding. Turn pot and pan handles inward, so children cannot pull them down and be burned.
- ▶ Danger of suffocation. While playing, children may become entangled in packaging material (such as plastic wrapping) or pull it over their head, presenting the risk of suffocation. Keep packaging material away from children.
- ▶ Activate the system lock to ensure that children cannot turn on the appliance inadvertently. Use the safety lock when the cooktop is in use to prevent children from altering the settings selected.

Technical safety

- ▶ Proper installation: Make sure that your appliance has been installed correctly and that it has been grounded by a qualified technician.
 - ▶ Maintenance by the user: Never repair or replace any part of the appliance unless the instructions specifically recommend doing so. Service work should only be performed by a qualified technician.
 - ▶ Unauthorized installation, maintenance, and repairs could result in unforeseen dangers for the user, for which the manufacturer cannot accept liability. Installation, maintenance, and repairs should only be carried out by a qualified specialist or Miele Service.
 - ▶ Damage to the cooktop can compromise your safety. Check the cooktop for visible signs of damage. Do not use the cooktop if it is damaged.
 - ▶ Temporary or permanent operation on an autonomous power supply system or a power supply system that is not synchronized with the grid power supply (e.g., island networks, back-up systems) is possible. A prerequisite for operation is that the power supply system complies with national and local codes.
- The function and operation of the protective measures provided in the domestic electrical installation and in this Miele product must also be maintained in isolated operation or in operation that is not synchronized with the grid power supply, or these measures must be replaced by equivalent measures in the installation.

IMPORTANT SAFETY INSTRUCTIONS

- ▶ The electrical safety of this cooktop can only be guaranteed when correctly grounded. It is essential that this basic safety requirement is fulfilled. If in doubt, the electrical installation should be checked by a qualified electrician.
- ▶ The connection data (voltage and frequency) on the data plate of the cooktop must match the power supply in order to avoid the risk of damage to the cooktop.
Compare this data before connecting the appliance. If in any doubt, consult a qualified electrician.
- ▶ Do not connect the appliance to the electrical supply with a power bar or extension cord. These are a fire hazard and do not guarantee the required safety of the appliance.
- ▶ For safety reasons, the cooktop may only be used when it has been fully installed.
- ▶ This cooktop must not be used at non-stationary installation sites (e.g., on a ship).
- ▶ Any contact with live connections or tampering with the electrical or mechanical components of the cooktop will endanger your safety and may lead to the cooktop malfunctioning.
Do not open the cooktop housing under any circumstances.
- ▶ The manufacturer's warranty may be invalidated if the cooktop is not repaired by a qualified specialist or by Miele Service.
- ▶ It is recommended to replace faulty components with original Miele parts. If original Miele parts are installed correctly, Miele ensures full compliance with safety requirements and the warranty remains valid.
- ▶ The appliance is not intended for use with an external timer switch or a remote control system.
- ▶ The cooktop must be connected to the electricity supply by a qualified electrician (see "Installation – Electrical connection").
- ▶ If the power supply cord is damaged, it must be replaced with a special power supply cord by a qualified electrician (see "Installation – Electrical connection").

IMPORTANT SAFETY INSTRUCTIONS

▶ The appliance must be completely disconnected from the electricity supply during installation, maintenance and repair work. Ensure that power is not supplied to the appliance until after it has been installed or until any maintenance or repair work has been carried out.

Disconnect by

- removing the fuse,
- “tripping” the circuit breaker, or
- unplugging the unit (if equipped with plug). Pull the plug not the cord.

▶ Danger of electric shock. Do not use the cooktop if it is faulty, or if the ceramic surface is cracked, chipped, or damaged in any way. Switch it off immediately. Disconnect the cooktop from the electrical power supply. Contact a qualified specialist or Miele Service.

▶ If the cooktop is installed behind a cabinet door, do not close the door while the cooktop is in operation. Heat and moisture can build up behind the closed door and cause damage to the cooktop, cabinetry, and flooring. Do not close the door until the residual heat indicators go out.

Correct use

▶ The cooktop gets hot when in use and remains hot for a while after being turned off. There is a potential hazard until the residual heat indicator goes out.

▶ Never leave the appliance unattended at high heat settings – Boilover causes smoking and greasy spillovers that may ignite.

▶ Oil and fat can catch fire if overheated. Never leave the appliance unattended when cooking with oil and fat. If the oil or fat catches fire, do not attempt to put the flames out with water.

Turn off the cooktop and smother the flames using a lid or a suitable fire blanket.

▶ Do Not Use Water on Grease Fires – Smother fire or flame or use dry chemical or foam-type extinguisher.

▶ Storage in or on the appliance: Flammable materials should not be stored in an oven or in the vicinity of the appliance.

▶ The flames could set the grease filters of a ventilation hood on fire. Do not flambé under a ventilation hood.

IMPORTANT SAFETY INSTRUCTIONS

- ▶ Spray canisters, aerosols and other inflammable substances can ignite when heated. Therefore do not store such items or substances in a drawer under the appliance. Cutlery inserts must be heat-resistant.
- ▶ Never heat empty cookware.
- ▶ Do not heat or can food in closed containers, such as tins or sealed jars, on the cooktop, as pressure will build up in the container and cause it to explode.
- ▶ If the cooktop is covered, there is a risk that the material of the cover will ignite, explode or melt if the cooktop is still hot or if turned on inadvertently. Never cover the cooktop with a board, cloth or protective sheet.
- ▶ If the cooktop is turned on or accidentally turned on or if it is still hot, metal objects on the cooktop can heat up. Other items may melt or catch fire. Damp lids can become attached to the cooktop by suction. Do not store items on the cooktop! Always turn the cooking zones off after use!
- ▶ You could burn yourself on the hot cooktop. Protect your hands with heat-resistant pot holders or gloves when handling hot pots and pans. Do not let them get wet or damp, as this causes heat to transfer through the material more quickly with the risk of scalding or burning yourself.
- ▶ When using an electrical appliance (e.g., a hand mixer) near the cooktop, make sure that the power cord does not come into contact with the hot cooktop. The cord's insulation could become damaged.
- ▶ Grains of salt, sugar and sand (e.g. from cleaning vegetables) can cause scratches if they get under pan bases. Make sure that the ceramic surface is clean before placing pans on it.
- ▶ Even a light object can cause damage to the ceramic cooktop in certain circumstances. Do not drop anything on the ceramic surface.
- ▶ Do not place hot pans on the sensor buttons and display as this could cause damage to the electronics underneath. Do not place hot pans on the area around the display.

IMPORTANT SAFETY INSTRUCTIONS

- ▶ Do not allow solid or liquid sugar, or pieces of plastic or aluminum foil to get onto the cooktop when it is hot, as they can damage the ceramic surface when it cools down. If this should occur, turn off the appliance immediately and scrape off all the sugar, plastic or aluminum residues while still hot, using a shielded scraper blade. Use pot holders. Allow the ceramic surface to cool down before cleaning with a suitable ceramic cleaning agent.
- ▶ Do not heat empty pots on the cooktop as this can damage the ceramic surface and/or the cookware. Never leave the cooktop unattended when it is turned on.
- ▶ Pots and pans with bases with pronounced edges or ridges can scratch the ceramic surface. Only use pots and pans with smooth bases.
- ▶ Lift pans into position on the cooktop. Sliding them into place can cause scuffs and scratches.
- ▶ Wear Proper Apparel – Loose-fitting or hanging garments should never be worn while using the appliance.
- ▶ Because induction heating works so quickly, the temperature can quickly reach the ignition point of oils and fats. Never leave the cooktop unattended when it is turned on.
- ▶ Do not heat oils and fats for longer than 1 minute, and never use the booster.
- ▶ For people who have a heart pacemaker: Please note that an electromagnetic field is created in the area immediately surrounding the cooktop when it is switched on. It is very unlikely to affect a pacemaker. However, if in any doubt, consult the manufacturer of the pacemaker or your doctor.
- ▶ When switched on, the electromagnetic field of the cooktop can impair the function of magnetizable objects. Do not leave credit cards, digital storage devices, pocket calculators, etc. in the immediate vicinity of the cooktop.
- ▶ Metal utensils stored in a drawer under the cooktop can become hot if the appliance is used intensively for a long time.
- ▶ The cooktop is equipped with a cooling fan. If a drawer is located directly underneath the cooktop, ensure that there is sufficient space between the drawer and its contents and the underside of the cooktop in order to ensure sufficient ventilation for the cooktop.

IMPORTANT SAFETY INSTRUCTIONS

- ▶ If a drawer is located directly underneath the cooktop, do not store any pointed or small items, paper, napkins, etc. in the drawer. They could get in through the ventilation slots or be sucked into the casing by the fan and damage the fan or impair cooling.
- ▶ Do not use 2 items of cookware on a cooking zone or extended zone at the same time.
- ▶ If the cookware only partially covers a cooking zone, the handle could become very hot.
Always place cookware in the middle of the cooking zone.
- ▶ Wet sponges or cloths can cause burns due to hot steam if they are used to wipe spilled food off a hot cooktop. Some cleansers can emit hazardous vapors if they are applied to a hot surface. Be careful when cleaning the cooktop.
- ▶ If the cooktop is damaged, cleansers or spilled food can penetrate the glass surface and cause a short-circuit. Never cook on a damaged cooktop. Contact an electrician immediately.
- ▶ If an induction adapter plate is used for cookware, the induction generators may be damaged or even destroyed. Do not use induction adapter plates.

Cleaning and maintenance

- ▶ The steam from a steam cleaner could reach live electrical components and cause a short circuit.
Do not use a steam cleaner to clean the cooktop.

Sustainability and environmental protection

Energy-saving tips when cooking

- Cook in covered pots and pans if possible. This prevents heat escaping unnecessarily.
- Cook with as little water as possible.
- Once food has come to a boil or the pan is hot for frying, reduce the heat to a lower power level.
- Use a pressure cooker to reduce cooking durations.

deleting any personal data left on the appliance being disposed. Please ensure that your old appliance is kept away from children until removal. Observe safety requirements for appliances that may tip over or pose an entrapment hazard.

Disposal of the packing material

The cardboard box and packing materials protect the appliance during shipping.

Ensure that any plastic wrappings, bags, etc. are disposed of safely and kept out of the reach of children. Danger of suffocation!

Disposal of your old appliance

Electrical and electronic appliances contain valuable materials. They also contain certain substances, compounds and components which were essential for the proper functioning and safe use of the equipment. Handling these materials improperly by disposing of them in your household waste can be harmful to your health and the environment. Therefore, please do not dispose of your old appliance with regular household waste and follow local regulations on proper disposal.



Consult with local authorities, dealers or Miele in order to dispose of and recycle electrical and electronic appliances. Miele assumes no responsibility for

Safety distances

Safety distance above the cooktop

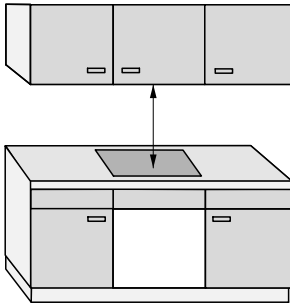

The following must be ensured between the cooktop and the ventilation hood above it:

- The safety distance specified by the manufacturer of the hood must be maintained.
- When two or more appliances which have different safety distances are installed together below a ventilation hood, the greatest specified safety distance must be maintained.

If combustible objects are installed above the cooktop (e.g., a suspended rack), a minimum safety distance of 19 3/4" (500 mm) must be maintained.

Installation

Safety distance behind and to the side of the cooktop

The minimum safety distances shown below must be maintained between the appliance and a tall cabinet or wall:

- between the **back** ① of the countertop cut-out and the rear edge of the countertop:
2" (50 mm)

and

- on the **right side** ② between the countertop cut-out and the closest adjacent piece of furniture (e.g., tall cabinet) or a room wall:
2" (50 mm) and on the opposite side a minimum safety distance of 7 7/8" (200 mm)

or

- on the **left side** ③ between the countertop cut-out and the closest adjacent piece of furniture (e.g., tall cabinet) or a room wall:
2" (50 mm) and on the opposite side a minimum safety distance of 7 7/8" (200 mm)

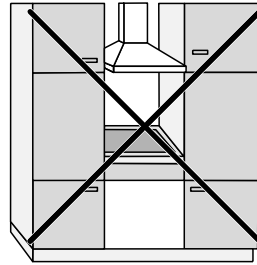

Not allowed

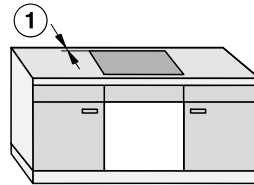
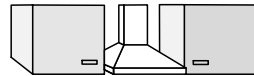

Highly recommended

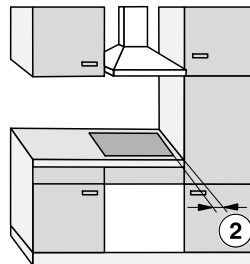

Not recommended

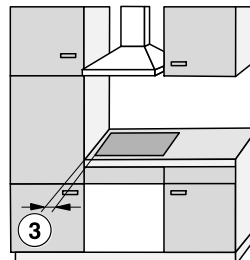

Not recommended

Minimum safety distance underneath the cooktop

To ensure sufficient ventilation to the cooktop, a minimum safety distance must be left between the underside of the cooktop and any oven, protective base, or drawer.

Minimum safety distance between underside of cooktop and	KM 7720 FR, KM 7740 FR	KM 7730 FR
Upper edge of drawer	$\geq 3/16''$ (5 mm)	
Base of drawer	$\geq 3''$ (75 mm)	
Upper edge of oven	$\geq 9/16''$ (15 mm)	
Upper edge of protective base	$\geq 9/16''$ (15 mm)	$\geq 3\ 3/4''$ (95 mm)

Protective base

Installation of a protective base under the cooktop is allowed but not required.



Side view

- ① Front
- ② Rear air gap

Leave a air gap ② of 3'' (75 mm) at the back between the cabinet and the protective base to **accommodate the power supply cord**.

Safety distance from the wall covering

If a wall covering is installed, a minimum safety distance must be maintained between the countertop cut-out and the covering. High temperatures can alter or damage these materials.

Installation

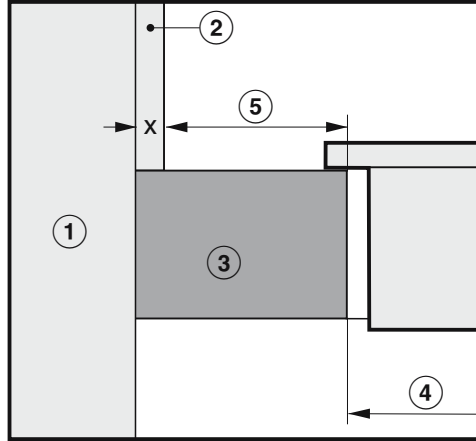

- ① Wall frame
- ② Dimension x = thickness of the wall covering material
- ③ Countertop
- ④ Countertop cut-out
- ⑤ Minimum safety distance to
 - combustible** materials (e.g., wood)
 - non-combustible** materials (e.g., metal, natural stone, ceramic tiles)

Material	Side		Opposite side	
	Com- bustible	Non-combustible	Com- bustible	Non-combustible
Back	2" (50 mm)	2" (50 mm) – dimension x	–	–
Right	2" (50 mm)	2" (50 mm) – dimension x	7 7/8" (200 mm)	7 7/8" (200 mm) – dimension x
Left	2" (50 mm)	2" (50 mm) – dimension x	7 7/8" (200 mm)	7 7/8" (200 mm) – dimension x

See “Installation – Safety distances”

Example: 1/2" (15 mm) thick non-combustible wall covering
 2" (50 mm) – 1/2" (15 mm) = minimum safety distance of 1 3/8" (35 mm)

Installation dimensions

KM 7720 FR

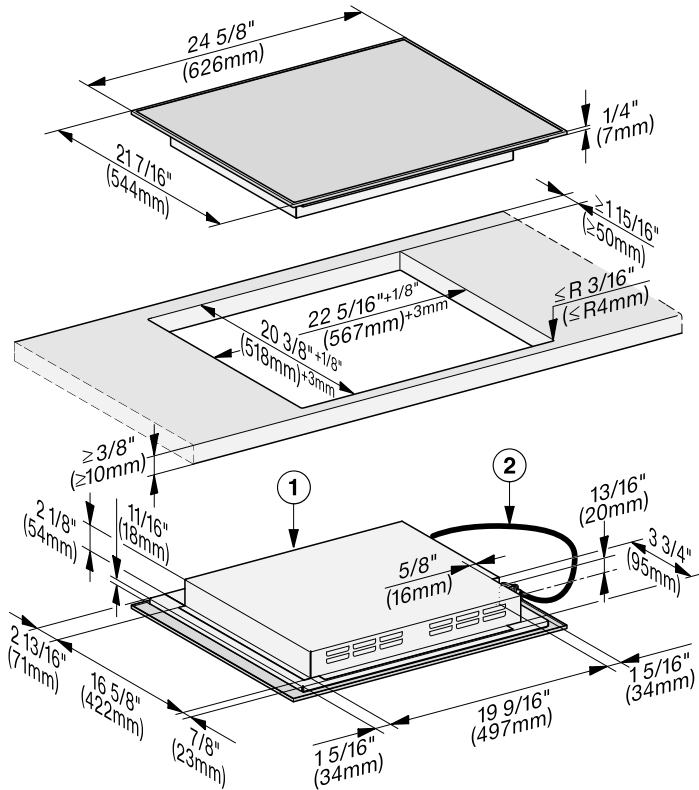

All dimensions are given in mm and inches. The superscript numbers after the cut-out dimensions are the tolerances for the cut-out.

- ① Front
- ② Flexible metal hose with power cords,
L = 4' (1,200 mm)

Installation

KM 7730 FR

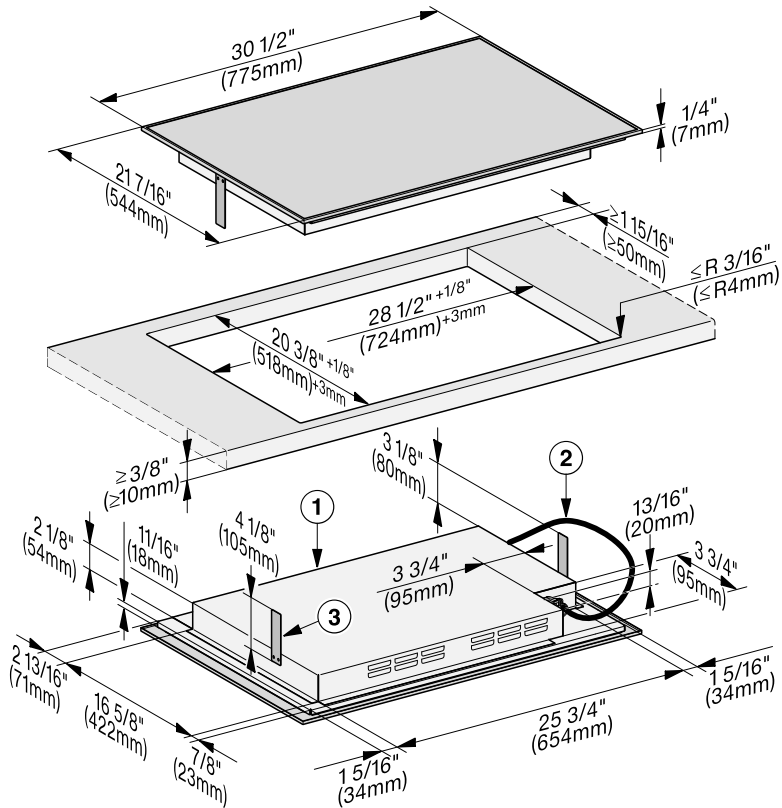

All dimensions are given in mm and inches. The superscript numbers after the cut-out dimensions are the tolerances for the cut-out.

- ① Front
- ② Flexible metal hose with power cords,
L = 4' (1,200 mm)
- ③ Spacer plate (only required if a protective base is installed)

KM 7740 FR

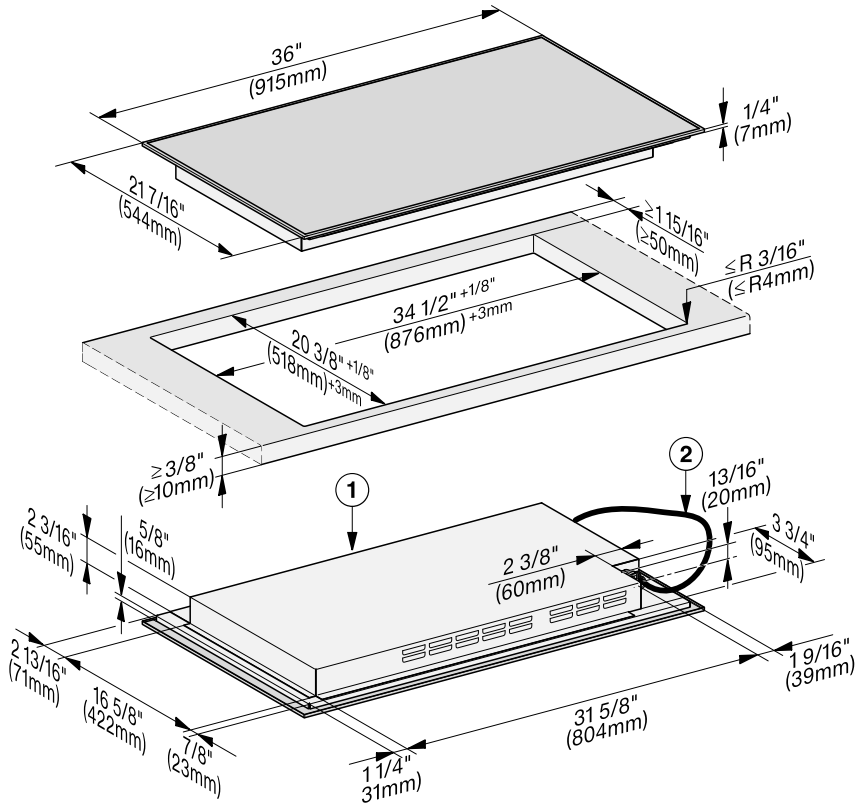

All dimensions are given in mm and inches. The superscript numbers after the cut-out dimensions are the tolerances for the cut-out.

- ① Front
- ② Flexible metal hose with power cords, L = 4' (1,200 mm)

Installation

Installing the cooktop

Preparing the countertop for installation

- Remember to maintain the minimum safety distances (see “Installation – Safety distances”).
- Create the countertop cut-out.
- Wooden countertops:
Seal any cut surfaces with a special varnish, silicone sealant, or resin to prevent the wood from swelling as a result of moisture ingress. The sealant must be temperature-resistant.

Ensure that the sealant does not get on the top surface of the countertop.

Installing the cooktop

The sealing strip ensures that the cooktop will sit securely in the cut-out without slipping. Any gap between the frame and countertop will become smaller over time.

- Attach the sealing strip included in the scope of delivery underneath the edge of the cooktop. The joint edge (start and end) of the sealing strip must not be in a corner. Apply some silicone joint sealant to the joint edge of the sealing strip. Do not apply the sealing strip under tension.

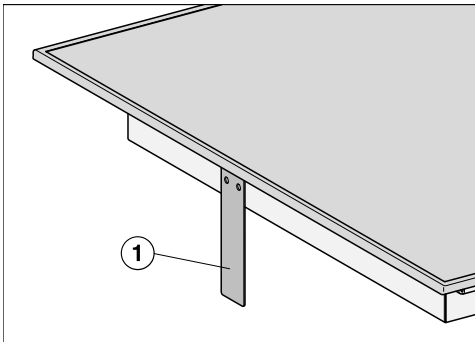

- KM 7730 FR If a protective base is to be installed, fasten one spacer plate ① on both the left and right side of the cooktop.
- Feed the cooktop power cord down through the cut-out in the countertop.
- Place the cooktop in the center of the cut-out. When doing this, make sure that the seal of the appliance sits flush with the countertop on all sides. This is important to ensure an effective seal all round.
- If the seal does not sit flush with the countertop in the corners, the corner radius ($\leq R4$) can be carefully cut to fit using a jigsaw.
- Connect the cooktop to the power supply (see “Installation – Electrical connection”).
- Check that the cooktop works.

Electrical connection

 Damage through improper work. Installation, repair, and maintenance work performed by unqualified persons can cause considerable danger to users. Miele cannot be held liable for any damage arising as a result of such work.

Installation, repair and maintenance work should only be performed by a Miele-authorized qualified electrician in compliance with local regulations and the ANSI National Electrical Code/NFPA 70 in the United States or the Canadian Electric Code, CSA C22.1-02. in Canada.

Danger of electric shock.

There is a risk of electric shock when performing installation, repair, and service work .

Before performing installation, repair, and service work, disconnect the power supply by either removing the fuse, shutting off the main power or manually “tripping” the circuit breaker.

Danger of electric shock by missing or interrupted grounding.

The appliance may be energized.

To guarantee the electrical safety of this appliance, continuity must exist between the appliance and an effective grounding system. It is imperative that this basic safety requirement be met. If there is any doubt, have the electrical system of the house checked by a qualified electrician.

Damage by incorrect connection.

If the household electrical supply is not suitable for the appliance, it can be damaged.

The voltage and frequency listed on the data plate must correspond with the household electrical supply to prevent damage to the appliance. Ensure that the connection data on the data plate match those of your electrical supply. Consult an electrician if in doubt.

For safety reasons, the cooktop may only be used when it has been fully installed into the countertop.

- Important – Save these instructions for the local electrical inspector’s use.

Connection

- Ensure that the connection data on the data plate (voltage, frequency, and fuse rating) match those of your electrical supply.

The data plate is located underneath the appliance.

The appliance is approved and ready for connection to a grounded connector with three connecting wires, sheathed by a flexible metal hose.

It must be connected to an assigned line in an approved connecting socket.

The appliance must be able to be disconnected from the power supply on all poles by disconnecting devices. When turned off, a contact distance of at least 1/8" (3 mm) must be present. The disconnecting devices are overcurrent protection elements and protective circuit breakers.

Black: Connect to L1 (hot)

Red: Connect to L2 (hot)

Green: Connect to GND (ground)

KM 7720, KM 7730

208/240 V, 60 Hz, minimum 32 A
(select a higher protection level if necessary)

KM 7740

208/240 V, 60 Hz, minimum 48 A
(select a higher protection level if necessary)

Make sure that the power outlet is accessible after the installation of the appliance.

Further information can be found on the included data plate.

Installation



**WARNING:
THIS APPLIANCE MUST BE
GROUNDED**

Your cooktop

KM 7720 FR

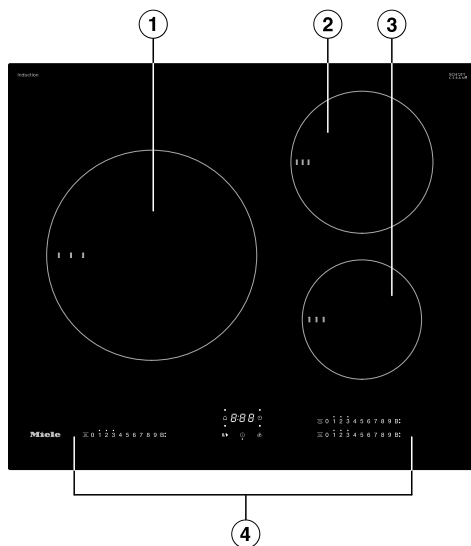

- ① Cooking zone with TwinBooster
- ② Cooking zone with TwinBooster
- ③ Cooking zone with TwinBooster
- ④ Controls and indicators

Overview

KM 7730 FR

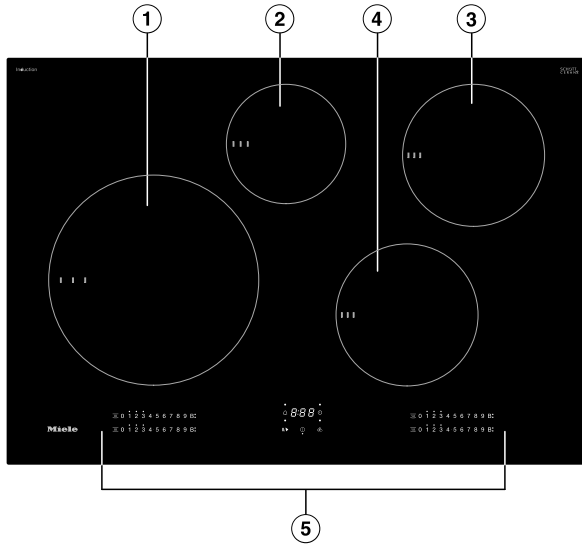

- ① Cooking zone with TwinBooster
- ② Cooking zone with TwinBooster
- ③ Cooking zone with TwinBooster
- ④ Cooking zone with TwinBooster
- ⑤ Controls and indicators

KM 7740 FR

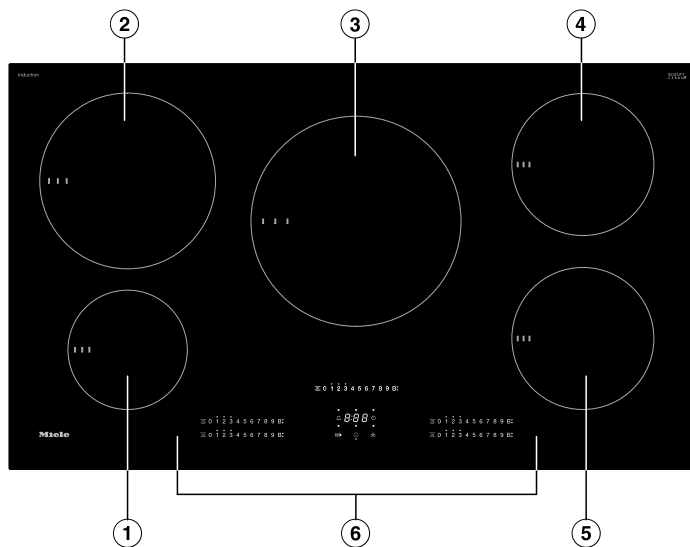

- ① Cooking zone with TwinBooster
- ② Cooking zone with TwinBooster
- ③ Cooking zone with TwinBooster
- ④ Cooking zone with TwinBooster
- ⑤ Cooking zone with TwinBooster
- ⑥ Controls and indicators

Overview

Controls and indicators

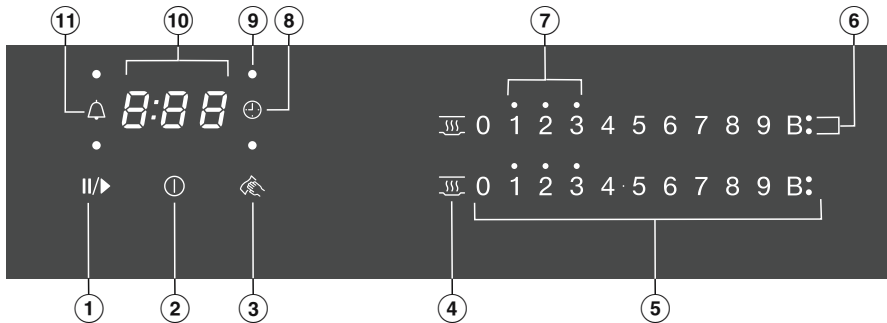

- ① Stop & Go sensor control
For stopping/starting a cooking process in progress
- ② Cooktop On/Off sensor control
- ③ Wipe protection sensor control
For locking the sensor controls
- ④ Keeping warm sensor control
For activating/deactivating the Keeping warm function
- ⑤ Numerical display
 - For setting the power level
 - For setting the times
- ⑥ Booster display
Booster function is activated
- ⑦ Residual heat indicators
- ⑧ Automatic reduce sensor button
Automatically reduces the cooking zones to power level 1
- ⑨ Cooking zone assignment indicator light
Automatic reduce for the cooking zone is activated
- ⑩ Timer display
 - 00* to *99* Time in minutes
 - LC* System lock/safety lock is activated
 - dE* Demo mode is activated
- ⑪ Kitchen timer sensor control

Cooking zone data

KM 7720 FR				
Cooking zone	Ø in inches (cm) ¹	Max. rating in watts for 208 V ²		Linked cooking zone ³
①	7"–11" (18–28 cm)	Normal	2,400	-
		TwinBooster, level 1	2,750	
		TwinBooster, level 2	3,350	
②	5 1/2"–7 1/2" (14–19 cm)	Normal	1,700	③
		TwinBooster, level 1	2,300	
		TwinBooster, level 2	2,750	
③	4"–6 1/2" (10–16 cm)	Normal	1,300	②
		TwinBooster, level 1	1,550	
		TwinBooster, level 2	2,000	
		Total	6,600	

¹ Cookware with a base diameter within the given range may be used.

² The power indicated may vary depending on the size and material of the cookware used.

³ The cooking zone is linked to this cooking zone electrically so that the rating can be increased; see "Overview – Power management system".

Overview

KM 7720 FR				
Cooking zone	Ø in inches (cm) ¹	Max. rating in watts for 240 V ²		Linked cooking zone ³
①	7"–11" (18–28 cm)	Normal	2,600	-
		TwinBooster, level 1	3,000	
		TwinBooster, level 2	3,700	
②	5 1/2"–7 1/2" (14–19 cm)	Normal	1,850	③
		TwinBooster, level 1	2,500	
		TwinBooster, level 2	3,000	
③	4"–6 1/2" (10–16 cm)	Normal	1,400	②
		TwinBooster, level 1	1,700	
		TwinBooster, level 2	2,200	
		Total	7,600	

¹ Cookware with a base diameter within the given range may be used.

² The power indicated may vary depending on the size and material of the cookware used.

³ The cooking zone is linked to this cooking zone electrically so that the rating can be increased; see "Overview – Power management system".

KM 7730 FR				
Cooking zone	Ø in inches (cm) ¹	Max. rating in watts for 208 V ²		Linked cooking zone ³
①	7"–11" (18–28 cm)	Normal	2,400	②
		TwinBooster, level 1	2,750	
		TwinBooster, level 2	3,350	
②	4"–6 1/2" (10–16 cm)	Normal	1,300	①
		TwinBooster, level 1	1,550	
		TwinBooster, level 2	2,000	
③	5 1/2"–7 1/2" (14–19 cm)	Normal	1,700	④
		TwinBooster, level 1	2,300	
		TwinBooster, level 2	2,750	
④	5 1/2"–7 1/2" (14–19 cm)	Normal	1,700	③
		TwinBooster, level 1	2,300	
		TwinBooster, level 2	2,750	
		Total	6,600	

¹ Cookware with a base diameter within the given range may be used.

² The power indicated may vary depending on the size and material of the cookware used.

³ The cooking zone is linked to this cooking zone electrically so that the rating can be increased; see "Overview – Power management system".

Overview

KM 7730 FR				
Cooking zone	Ø in inches (cm) ¹	Max. rating in watts for 240 V ²		Linked cooking zone ³
①	7 1/16–11" (18–28 cm)	Normal	2.600	②
		TwinBooster, level 1	3.000	
		TwinBooster, level 2	3.700	
②	3 15/16–6 5/16" (10–16 cm)	Normal	1.400	①
		TwinBooster, level 1	1.700	
		TwinBooster, level 2	2.200	
③	5 1/2"–7 1/2" (14–19 cm)	Normal	1.850	④
		TwinBooster, level 1	2.500	
		TwinBooster, level 2	3.000	
④	5 1/2"–7 1/2" (14–19 cm)	Normal	1.850	③
		TwinBooster, level 1	2.500	
		TwinBooster, level 2	3.000	
		Total	7.600	

¹ Cookware with a base diameter within the given range may be used.

² The power indicated may vary depending on the size and material of the cookware used.

³ The cooking zone is linked to this cooking zone electrically so that the rating can be increased; see "Overview – Power management system".

KM 7740 FR				
Cooking zone	Ø in inches (cm) ¹	Rating in watts for 208 V ²		Linked cooking zone ³
①	4"–6 1/2" (10–16 cm)	Normal TwinBooster, level 1 TwinBooster, level 2	1,300 1,550 2,000	②
②	6 1/2"–9" (16–23 cm)	Normal TwinBooster, level 1 TwinBooster, level 2	2,100 2,750 3,350	①
③	7"–11" (18–28 cm)	Normal TwinBooster, level 1 TwinBooster, level 2	2,400 2,750 3,350	-
④	5 1/2"–7 1/2" (14–19 cm)	Normal TwinBooster, level 1 TwinBooster, level 2	1,700 2,300 2,750	⑤
⑤	5 1/2"–7 1/2" (14–19 cm)	Normal TwinBooster, level 1 TwinBooster, level 2	1,700 2,300 2,750	④
		Total	9,900	

¹ Cookware with a base diameter within the given range may be used.

² The power indicated may vary depending on the size and material of the cookware used.

³ The cooking zone is linked to this cooking zone electrically so that the rating can be increased; see "Overview – Power management system".

Overview

KM 7740 FR				
Cooking zone	Ø in inches (cm) ¹	Rating in watts for 240 V ²		Linked cooking zone ³
①	4"–6 1/2" (10–16 cm)	Normal TwinBooster, level 1 TwinBooster, level 2	1,400 1,700 2,200	②
②	6 1/2"–9" (16–23 cm)	Normal TwinBooster, level 1 TwinBooster, level 2	2,300 3,000 3,700	①
③	7"–11" (18–28 cm)	Normal TwinBooster, level 1 TwinBooster, level 2	2,600 3,000 3,700	-
④	5 1/2"–7 1/2" (14–19 cm)	Normal TwinBooster, level 1 TwinBooster, level 2	1,850 2,500 3,000	⑤
⑤	5 1/2"–7 1/2" (14–19 cm)	Normal TwinBooster, level 1 TwinBooster, level 2	1,850 2,500 3,000	④
		Total	11,500	

¹ Cookware with a base diameter within the given range may be used.

² The power indicated may vary depending on the size and material of the cookware used.

³ The cooking zone is linked to this cooking zone electrically so that the rating can be increased; see "Overview – Power management system".

Power management system

Distribution of power

Cooking zones can be linked together in pairs on the cooktop. This allows power to be transferred from one cooking zone (A) to another (B). As a result, the power of cooking zone (A) is reduced.

Example: The Booster function for cooking zone (B) is activated.

The cooking zone (B) which requires power is determined by the most recently selected setting on the cooktop.

The values for the maximum total permitted power consumption and which cooking zones are linked together can be found in "Overview – Cooking zone data".

Effects of power distribution

If a cooking zone gives power to another zone, this can have the following effects on the zone giving the power:

- The power level is reduced.
- Auto heat-up will be deactivated. Cooking continues at the set level. If the power is not sufficient, the power level will be reduced again.
- The Booster function is deactivated.
- The cooking zone is switched off.

When the cooking zone stops transferring power to another zone, the power level can be increased again.

Tip: If you wish to cook a large quantity of food on one cooking zone, switch the other cooking zones to lower power levels.

Operation

Cooktop when switched off

When the cooktop is switched off, you can only see the printed symbols for the sensor controls and the numerical display. More sensor controls light up when the cooktop is switched on.

Networking

Your cooktop is equipped with an integrated Wi-Fi module. The cooktop can be connected to your home Wi-Fi network or simply to your Miele ventilation hood.

Connecting to a network

After installing the Miele app on a mobile device, you can do the following:

- call up information on the operating status of your cooktop
- call up information on the program sequence of your cooktop
- set up a network with other Wi-Fi-enabled Miele domestic appliances
- call up recipes with the Miele app
- control a connected Miele ventilation hood automatically via the cooktop settings (Con@ctivity 3.0)

Connection only with the ventilation hood

Once you have established a connection with a Miele ventilation hood, you can do the following:

- control a connected Miele ventilation hood automatically via the cooktop settings (Con@ctivity 3.0)

Overview

Special functions

Con@ctivity 3.0

Con@ctivity 3.0 is the direct communication system between your cooktop and a Miele ventilation hood. Communication is achieved by means of networking. Con@ctivity 3.0 enables the ventilation hood to operate automatically depending on the operating status of your cooktop.

The Con@ctivity versions of the cooktop and the ventilation hood must match.

Additional information can be found in the operating and installation instructions for your ventilation hood.

Permanent pan recognition

When you place cookware on a cooking zone, the numerical display for the cooking zone is activated automatically.

Pan size recognition

The size of the cookware is detected within a cooking zone. The release of energy is adapted to the size of the pan.

Cooktop Booster

When the Booster function is activated, the power is boosted so that large quantities can be heated up quickly, e.g., when boiling water for cooking pasta.

Auto heat-up

When Auto heat-up has been activated, the cooking zone switches on automatically at the highest setting and then switches to the power level (continued cooking level) which you have previously selected.

Timer

The timer can be used for the following 2 functions:

- setting the kitchen timer
- reduce automatically to power level 1

You can use the functions simultaneously.

Kitchen timer

You can set a timer for activities that are independent of the cooktop.

Safety shut-off

You can set a time after which the cooking zone will switch off automatically. This function can be used on all cooking zones at the same time.

System lock

If the system lock is activated, then the cooktop cannot be switched on.

Safety lock

The safety lock is activated while the cooktop is switched on. When the safety lock is activated, the cooktop can only be operated to a limited extent.

Recall

If the cooktop is switched off by mistake during use, this function can be used to restore all settings. The cooktop must be switched on again within 10 seconds of being switched off.

Keeping warm

This special function enables food to be kept warm after it has finished cooking. The maximum duration for keeping food warm is 2 hours.

Settings

You can adapt the settings of the cooktop to your personal needs.

You can adjust the safety shut-off by changing the safety setting (see “Customizing settings”).

Demo mode

This function enables the cooktop to be demonstrated in dealer showrooms without heating up.

Residual heat indicator

If a cooking zone is still hot, the residual heat indicator will light up after it has been switched off. Depending on the temperature, a dot will appear above power levels 1, 2, and 3.

The dots in the residual heat indicator go out one by one as the cooking zones cool down. The last dot only goes out when the cooking zone is safe to touch.

Safety shut-off

Sensor controls are covered

Your cooktop will turn off automatically if one or several of the sensor controls remain covered for longer than 10 seconds; for example, by finger contact, food boiling over, or an object.

① flashes briefly above the \mathcal{L} sensor control and a tone will sound.

\mathcal{L} will go out once you have removed the object and/or cleaned the soiling and the cooktop will be ready to use again.

Excessive operating time

The safety shut-off mechanism is triggered automatically if a cooking zone is heated for an unusually long period of time. This time depends on the power level selected. If the time has been exceeded, the cooking zone switches to power level 1. If you turn the cooking zone off and on again, it will be ready for operation again.

Overview

Power level ¹	Maximum operating time [h:min]		
	Safety setting		
	0 ²	1	2
1	10:00	8:00	5:00
1.	10:00	7:00	4:00
2/2.	5:00	4:00	3:00
3/3.	5:00	3:30	2:00
4/4.	4:00	2:00	1:30
5/5.	4:00	1:30	1:00
6/6.	4:00	1:00	0:30
7/7.	4:00	0:42	0:24
8	4:00	0:30	0:20
8.	4:00	0:30	0:18
9	1:00	0:24	0:10

¹ The power levels with a dot are intermediate levels (see “Setting ranges”).

² Factory default setting

Overheating protection

In order to prevent the cooktop from being damaged by excessive temperatures, the overheating protection mechanism intervenes in one of the following ways:

Overheating protection measures

- If the Booster function is switched on, it will stop.
- The set power level will be reduced.
- A cooking zone will switch off.
Err flashes alternately with *044* in the timer display.
- All cooking zones will switch off.

Triggering the overheating protection mechanism

The overheating protection may be activated under the following circumstances:

- The cookware being heated is empty.
- Fat or oil is being heated on a high power level.
- Insufficient ventilation to the underside of the cooktop.
- A hot cooking zone is turned back on after a power failure.

Cooktop data

The model number, serial number, and software version of the cooktop can be displayed.

Optional accessories

Cookware

Miele offers a wide range of cookware. These have all been optimized for Miele appliances in terms of functionality and dimensions. Detailed information can be found on the Miele website.

Cleaning and care products

Ceramic and stainless steel cleaner 250 mL

Removes heavy soiling, lime scale, and aluminum residue.

Microfiber cloth

Removes finger marks and light soiling.

Unpacking the cooktop

- Please stick the extra data plate for the appliance supplied with this documentation in the space provided in the “Customer Service” section of this manual.
- Remove any protective foil and stickers.

Cleaning the cooktop for the first time

- Before using it for the first time, clean the cooktop with a damp cloth.
- Wipe the cooktop dry.

Switching on the cooktop for the first time

The metal components have a protective coating. When the cooktop is used for the first time, this causes a smell and possibly also vapor. The heating of the induction coils also causes odors in the first few hours of operation. With each subsequent use, the odors are reduced until they disappear completely. The smell and any vapors do not indicate a faulty connection or a defective appliance and are not harmful to your health.

Networking

The Wi-Fi connection shares a frequency range with other appliances (including microwave ovens and remote control toys). This can give rise to sporadic or even complete connection failures. Therefore, the availability of featured functions cannot be guaranteed.

Connecting to a network via WPS

- A home Wi-Fi network is available.
- The signal of your Wi-Fi network is sufficiently strong in the place where your cooktop is installed.
- There is no direct Wi-Fi connection between the cooktop and a Miele ventilation hood (Con@ctivity 3.0).
- You must have a WPS (Wi-Fi protected setup) compatible router.

- Switch the cooktop on.
- Touch the 0 sensor control on any of the numerical displays.
- Touch the 0 and 6 sensor controls at the same time for 6 seconds.

The seconds can be seen counting down in the timer display. After the time has elapsed, a progress light appears in the timer display during the connection attempt (for max. 120 seconds).

The WPS login is active during these 120 seconds.

- Activate the WPS function on your Wi-Fi router.

If the connection was successful, the code `Ⓛ:D2` appears in the timer display. If the connection could not be established, the timer display will show the code `Ⓛ:D1`. You have probably not activated WPS on your router quickly enough. Repeat the steps above.

- Install the Miele app.
- Follow the user navigation in the app.

You can use all Miele@home functions.

Tip: If your Wi-Fi router does not support WPS, please connect via the Miele app.

Commissioning

Connecting only with a ventilation hood

You can find the necessary information on connecting the ventilation hood in the associated operating and installation instructions.

- Miele ventilation hood with Con@ctivity 3.0
- The cooktop is not connected to your home network (Miele@home)

- Switch the cooktop on.
- Press the 0 sensor control on any numerical display.
- Touch the 0 and 7 sensor controls at the same time for 6 seconds.

The seconds can be seen counting down in the timer display. After the time has elapsed, a progress light appears in the timer display during the connection attempt. If the connection was successful, the code `C:02` appears in the timer display. If the connection could not be established, the timer display will show the code `C:01`. Repeat the steps above.

When successfully connected, 2 and 3 will light up constantly on the ventilation hood.

- Quit connection mode on the ventilation hood by pressing the run-on  button.

Con@ctivity 3.0 is now activated.

Canceling the process

- Touch any sensor control.

Resetting settings

Reset the settings if you are disposing of your cooktop, selling it, or putting a used cooktop into operation. This is the only way to ensure that all personal data

has been removed and the previous owner will no longer be able to access the cooktop.

Resetting is not required when replacing the router.

- Switch the cooktop on.
- Press the 0 sensor control on any numerical display.
- Touch the 0 and 9 sensor controls at the same time for 6 seconds.

The seconds can be seen counting down in the timer display.

After this time has elapsed, the code `C:00` is displayed in the timer display for 10 seconds.

Safety notes for operation

 Risk of fire due to overheated food.

Unattended food can overheat and ignite.

Do not leave the cooktop unattended while it is being used.

 Risk of burning or scalding due to hot cooking zones.

The cooking zones will be hot after use.

Do not touch the cooking zones while the residual heat indicators are on.

 Risk of burning due to hot items.

When the cooktop is switched on either deliberately or by mistake, or when there is residual heat present, there is the risk of metal items placed on the cooktop heating up.

Do not store items on the cooktop.

After use, switch the cooktop off with the  sensor control.

The cooking result can be negatively affected if food is kept warm at excessively high temperatures. Food can change color and even spoil.

 Placing hot cookware on the sensor controls and indicators can damage the electronic underneath.

The sensor controls do not respond.

They may be switched on or off unintentionally.

The cooktop will switch itself off (see “Overview – Safety shut-off”).

Do not place hot cookware over the sensor controls or indicators.

Switching on the cooktop

- Touch the  sensor control.

Additional sensor controls will light up.

If no further entry is made, the cooktop will turn itself off after a few seconds for safety reasons.

Switching off a cooking zone/ the cooktop

Switching off the cooktop

- To switch off the cooktop and all the cooking zones, touch the  sensor control.

Switching off a cooking zone

- To switch off a cooking zone, touch the 0 sensor control on the numerical display for that cooking zone.

Operation

Cooktop power levels

Setting the power level

Permanent pan recognition is activated as standard (see “Customizing settings”). When the cooktop is switched on and you place an item of cookware on one of the cooking zones, all the sensor controls for the numerical display will light up.

- Place the cookware on the cooking zone you want to use.
- Touch the  sensor button on the relevant numerical display.
- Touch the appropriate sensor control for the power level you want on the relevant numerical display.

Setting the power level – intermediate levels

The intermediate levels are activated (see “Customizing settings”).

- Press the numerical display between the sensor controls.

The numbers to the left and right of the intermediate level light up brighter than the other sensor controls.

Example:

If you have set power level 7, the numbers 7 and 8 will be brighter than the other numbers.

Changing the power level

- Touch the appropriate sensor control for the power level you want on the numerical display.

Booster

Activating the Booster function

When the Booster function is activated, the settings for the linked cooking zone may be changed (see “Overview – Power management system”).

The Booster function can be used on a maximum of 2 cooking zones at the same time.

The Booster function is active for a maximum of 15 minutes.

TwinBooster level 1

- Place the cookware on the cooking zone you want to use.
- Select a power level, if necessary.
- Touch the **B** sensor control.

The indicator light  for TwinBooster level 1 lights up.

TwinBooster level 2

- Place the cookware on the cooking zone you want to use.
- Select a power level, if necessary.
- Touch the **B** sensor control twice.

The indicator light  for TwinBooster level 2 lights up.

Deactivating the Booster function

- Touch the **B** sensor control repeatedly until the indicator lights go out.

or

- Select a different power level.

If you deactivate the Booster function or the Booster time comes to an end and

- no power level was selected before activating the Booster function, the cooking zone will revert automatically to level 9.

- a power level was selected before activating the Booster function, the cooking zone will revert automatically to the previously selected level.

Activating/deactivating Stop & Go

The power levels and the timer settings cannot be altered; the cooktop can only be switched off. The kitchen timer, switch-off, Booster, and heat-up times continue to run.

If the function is not deactivated within 1 hour, the cooktop will switch off.

- Touch the **II/▶** sensor control.

Auto heat-up

The heat-up time depends on which continued cooking level has been chosen:

Continued cooking level ¹	Heat-up time [min:sec]
1	approx. 00:15
1.	approx. 00:15
2	approx. 00:15
2.	approx. 00:15
3	approx. 00:25
3.	approx. 00:25
4	approx. 00:50
4.	approx. 00:50
5	approx. 2:00
5.	approx. 5:50
6	approx. 5:50
6.	approx. 2:50
7	approx. 2:50
7.	approx. 2:50
8	approx. 2:50
8.	approx. 2:50
9	—

¹ The power levels with a dot are intermediate levels.

Activating Auto heat-up

- Touch the sensor control for the continued cooking level you want until a tone sounds and the sensor control starts to pulsate.

During the heat-up time (see table) for a selected:

- continued cooking level, the set continued cooking level will pulsate
- interim power level, the sensor controls in front of and after the interim power level will pulsate

Operation

Deactivating Auto heat-up

- Tap the sensor control of the set continued cooking level.

or

- Select a different power level.

Timer

Setting timer durations

A duration of between 1 minute (0:01) and 9 hours 59 minutes (9:59) can be set.

Durations of up to 59 minutes are shown in minutes (00:59) and durations of more than 60 minutes are shown in hours and minutes.

Durations are entered:

- using the left or front left numerical display (depending on the model) in the case of a kitchen timer
- using the numerical display of the cooking zone to reduce automatically instead of an automatic reduce time

- Enter durations in the order of hours, followed by minutes in tens and then units.

Example:

59 minutes = 0:59 hours,

Enter: 5–9

80 minutes = 1:20 hours,

Enter: 1–2–0

After the first number has been entered, the timer display will light up constantly. After the second number has been entered, the first number will move to the left. After the third number has been entered, the first and second numbers will move to the left.

Setting the kitchen timer

- Touch the  sensor control.

The timer display flashes.

- Set the required duration (see “Timer – Setting timer durations”).

Touch the  sensor control or wait 10 seconds to start the kitchen timer.

Changing the kitchen timer



- Touch the  sensor control.

The timer display flashes.

- Set the required duration (see “Timer – Setting timer durations”).

Touch the  sensor control or wait 10 seconds to start the kitchen timer.

Deleting the kitchen timer

- Touch the  sensor control.
- Touch  on the numerical display.

Setting the switch-off time

A cooking zone will switch off when the maximum operating time has elapsed, independently of a set switch-off time (see “Overview – Safety shut-off”).

A power level is set for the desired cooking zone.

- Touch the  sensor control.

The timer display flashes.

- Set the required duration (see “Timer – Setting timer durations”).

Touch the  sensor control or wait 10 seconds to start the switch-off time.

The switch-off time for the cooking zone elapses and the cooking zone allocation safety shut-off indicator light pulsates.

Changing the switch-off time

- Touch the  sensor control repeatedly until the indicator light for the cooking zone you require pulsates.

The timer display flashes.

- Set the required duration (see “Timer – Setting timer durations”).

Touch the  sensor control or wait 10 seconds to start the reduce time.

The reduce time for the cooking zone elapses and the cooking zone reduce heating indicator light pulsates.

Deleting the reduce time

- Touch the  sensor control repeatedly until the indicator light for the cooking zone you require pulsates.

The timer display flashes.

- Touch the  sensor control on the numerical display.

Setting multiple reduce times

- To set a reduce time for another cooking zone, follow the steps described in “Operation – Setting the switch-off time”.

If more than one reduce time is programmed, the shortest time remaining will be displayed and the corresponding indicator light will pulsate. The other indicator lights light up constantly.



Displaying reduce times

- If you want to show the time left for another cooking zone which is counting down in the background, touch the  sensor control repeatedly until the indicator light for the desired cooking zone pulsates.

The **rounded** time left is displayed for the required cooking zone.

Using both timer functions at the same time

If you use both functions simultaneously, the shortest time is always displayed. The  sensor control (kitchen timer) or the indicator light of the cooking zone with the shortest reduce time pulsates.

- If you want to show the times left counting down in the background, touch the  or  sensor control.
- If a switch-off time has been programmed for several cooking zones, touch the  sensor control repeatedly until the indicator light for the required cooking zone pulsates.

System lock

Activating the system lock

All sensor controls are locked. A set kitchen timer will continue to count down.

- Touch the  sensor control for 6 seconds.

The seconds can be seen counting down in the timer display. When this time has elapsed, **LDC** will appear in the timer display. The system lock is activated.

If a disallowed sensor control is touched while the system lock is activated, **LDC** will appear in the timer display for a few seconds and a buzzer will sound.

The settings can be adjusted so that the system lock is activated automatically 5 minutes after the cooktop has been switched off (see “Customizing settings”).

Operation

Deactivating the system lock

- Touch the ① sensor control for 6 seconds.

LDC will appear briefly in the timer display and then the seconds will count down. The system lock is deactivated once the time has elapsed.

Safety lock

Activating the safety lock

When the safety lock is activated:

- the cooking zones and the cooktop can only be switched off
- a set kitchen timer can be modified
- Touch and hold the ⌚ and II/▶ sensor controls at the same time for 6 seconds.

The seconds can be seen counting down in the timer display. When this time has elapsed, *LDC* will appear in the timer display. The safety lock is activated.

If a disallowed sensor control is touched while the safety lock is activated, *LDC* will appear in the timer display for few seconds and a buzzer will sound.

Deactivating the safety lock

- Touch and hold the ⌚ and II/▶ sensor controls at the same time for 6 seconds.

LDC will appear briefly in the timer display and then the seconds will count down. Once the time has elapsed, the safety lock function is deactivated.

Activating the Recall function

- Switch the cooktop on again.
The previously set power levels flash.

- Press one of the flashing power level indicators immediately.
All settings are restored.

Cooktop data

Displaying the model number/serial number

There must not be any cookware on the cooktop.

- Switch the cooktop on.
- Press the 0 sensor control on any numerical display.
- Press the 0 and 4 sensor controls on the numerical display at the same time for 6 seconds.

Numbers will appear in the timer display one after another, separated by a dash.

Example: *12 34* (model number KM 1234) – *1 23 45 67 89* (serial number)

Displaying the software version

There must not be any cookware on the cooktop.

- Switch the cooktop on.
- Press the 0 sensor control on any numerical display.
- Press the 0 and 3 sensor controls on the numerical display at the same time for 6 seconds.

3 numbers appear in the timer display:

Example: *123* = software version 1.23.

Activating/deactivating demo mode

- Switch the cooktop on.

- Press the 0 sensor control on any numerical display.
- Press the 0 and 2 sensor controls on the numerical display at the same time for 6 seconds.

The following will flash in the timer display for a few seconds:

- dE alternating with On (demo mode activated)
or
- dE alternating with OFF (demo mode deactivated)

Setting ranges

The cooktop is programmed with 9 power levels without intermediate levels at the factory. If you wish to fine-tune the power levels, you can activate intermediate levels via the settings (see “Customizing settings”).

	Setting range	
	Factory setting 9 levels without intermediate lev- els	Finer setting 9 levels with intermediate lev- els
Melting butter, chocolate, etc. Dissolving gelatin Keeping soups and sauces warm	1–2	1–2.
Making vanilla puddings and other puddings	2	2–2.
Defrosting frozen vegetables (in a block) Keeping soups and sauces warm and preparing rice Preparing rolled oats, grits, polenta, risotto, rice pudding, couscous, dulce de leche	2–4	2.–4.
Cooking noodles, matzah balls, ravioli, gnocchi, and tortellini Poaching eggs Heating liquid and semi-solid dishes Preparing omelettes or fried eggs Steaming fruit, making compote Defrosting and heating frozen food	4–5	3.–5.
Steaming vegetables, fish, shellfish, mussels Gently frying eggs (without overheating the fat) Frying pancakes Preparing paella	5–6	4.–6.
Cooking large quantities of food, such as casseroles Thickening puddings and sauces, such as hollandaise Simmering for a stew Toasting nori, tortillas, pita, flat bread, etc. Toasting nuts Frying bacon	6–7	5.–7.
Searing meat, poultry, fish, or sausage Cooking meat (such as hamburgers, kebabs, and steaks), fish, and poultry Frying crêpes, etc.	6–8	6.–8.
Making jam and jelly	8	8–8.
Cooking meat, poultry, fish, and vegetables Cooking at hot temperatures in a wok, stir-frying	7–9	7.–9
Frying, e.g., French fries	9	8.-9
Boiling water or other liquid	Booster	Booster

These settings should only be taken as a guide. The power of the induction coils will vary depending on the voltage, size, and material of the cookware base. For this reason, it is possible that the power levels will need to be adjusted slightly to suit your cookware. As you use the cooktop, you will get to know which settings suit your cookware best. When using new cookware that you are not familiar with, set the power to one level below the one specified.

How induction cooktops work

An induction coil is located under each cooking zone. The coil creates a magnetic field that reacts directly with the base of the pan and heats it up. The cooking zone itself is heated up indirectly by the heat given off by the pan.

An induction cooking zone only works when a piece of cookware with a magnetic base is placed on it (see “Good to know – Cookware”). The cooktop automatically recognizes the size of the cookware.

Noises

When you use induction cooking zones, the following noises may occur, depending on the type and shape of the cookware base:

On the higher power levels, it might buzz. This will decrease or cease altogether when the power level is reduced.

Cookware with bases made of different materials (e.g., sandwich bases) may produce a crackling noise.

Whistling might occur if linked cooking zones (see “Operation – Booster”) are being used at the same time, and the cookware items also have bases made of layers of different materials (e.g., sandwich bases).

The electronics may produce a clicking sound, especially at lower power levels caused by switching operations.

You may hear a whirring sound when the cooling fan turns on. It turns on to protect the electronics when the cooktop is being used intensively. The fan may continue to run after the cooktop has been switched off.

Cookware

Suitable cookware

- stainless steel with a magnetic base
- enameled steel
- cast iron

The composition of the pan base can affect the evenness of the cooking results (e.g., when making pancakes). The base of the pan must be able to distribute the heat evenly. Cookware with a base made from multilayer material (tri-ply or encapsulated base) is ideal in this case.

Unsuitable cookware

- Stainless steel without a magnetic base
- Aluminum or copper
- Glass, ceramics, earthenware, stoneware

Testing cookware

To test whether a pot or pan is suitable for use on an induction cooktop, hold a magnet sticks to the base of the pan. If the magnet sticks, the cookware is generally suitable.

Cookware tips

- Position the cookware as centrally as possible on the relevant cooking zone/cooking area.
- To make optimum use of the cooking zones, choose cookware with a suitable base diameter (see “Overview – Cooking zone data”). If the cookware is too small it will not be recognized.
- Use only pots and pans with smooth bases. Rough bases can scratch the glass-ceramic surface.

Good to know

- When cooking zones are joined together, it is recommended to use cookware which more or less covers the entire cooking area (e.g., a roasting pan).
- Always lift the cookware to move it. This will help prevent scratching. If any scratches do appear as a result of cookware being pushed around, this will not affect the function of the cooktop. These scratches are normal signs of use.
- Please note that the pot or pan diameter quoted by manufacturers often refers to the maximum diameter or diameter of the top rim. The diameter of the base (generally smaller) is more important.

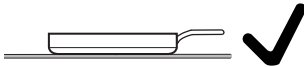

- Where possible, use cookware with vertically straight sides. If pans with sloped sides are used, the induction also takes effect around the edges of the pan. This can cause the edge of the pan to become discolored or the coating to peel off.

Calling up settings

The **II/▶** sensor control is located approx. 1/2" (1 cm) (index finger width) to the left of the **⓪** sensor control.

The cooktop is switched off.

- Touch and hold the **⓪** and **II/▶** sensor controls until the **⌚** sensor control lights up and **PC** appears in the timer display.

After a few seconds **P:01** (Program 01) will flash alternately with **C:01** (Code) in the timer display.

Setting parameters

For a two-digit parameter number you need to first set the tens position.

- While the parameter is visible in the display (e.g., **P:01**), press the **⌚** sensor control repeatedly until the number for the parameter you want appears in the display or touch the appropriate number on the numerical display.

Setting the code

- While the code is visible in the display (e.g., **C:01**), touch the **⌚** sensor control repeatedly until the number for the code you want appears in the display or touch the appropriate number on the numerical display.

Saving the settings

- While the program is visible in the display (e.g., **P:01**), touch the **⓪** sensor control until the indicators go out.

To avoid saving the settings

- While the code is showing in the display (e.g., **C:01**), touch the **⓪** sensor control until the indicators go out.

Customizing settings

Parameter ¹		Code	Settings ²
P:01	Demo mode	C:00	Demo mode off
		C:01	Demo mode on ³
P:03	Factory default	C:00	Do not restore factory default settings
		C:01	Restore factory default settings
P:04	Cooktop power level setting range	C:00	9 power levels without intermediate levels + Booster
		C:01	9 power levels with intermediate levels + Booster ⁴
P:06	Keypad tone when a sensor control is touched	C:00	Off ⁵
		C:01	Quiet
		C:02	Medium
		C:03	Loud
P:07	Audible signal for timer	C:00	Off
		C:01	Quiet
		C:02	Medium
		C:03	Loud
P:08	System lock	C:00	System lock can only be activated manually
		C:01	System lock activated automatically
P:09	Maximum operating time	C:00	Safety setting 0
		C:01	Safety setting 1
		C:02	Safety setting 2

Customizing settings

Parameter ¹		Code	Settings ²
P:10	WiFi registration	C:00	Not active/deactivated
		C:01	Active but not configured
		C:02	Active and configured (cannot be selected; displays whether connection was successful)
		C:03	Connection possible via WPS push button
		C:04	WiFi reset to default (C:00)
		C:05	Direct WiFi connection of cooktop and ventilation hood without Miele app (Con@ctivity 3.0)
P:12	Sensor control reaction speed	C:00	Slow
		C:01	Normal
		C:02	Fast
P:15	Permanent pan recognition	C:00	Permanent pan recognition off
		C:01	Permanent pan recognition on

Parameter ¹		Code	Settings ²
P:25	Keeping warm temperature	C:00	120°F (50°C)
		C:01	130°F (55°C)
		C:02	140°F (60°C)
		C:03	150°F (65°C)
		C:04	160°F (70°C)
		C:05	170°F (75°C)
		C:06	175°F (80°C)
		C:07	185°F (85°C)
		C:08	195°F (90°C)

¹ Programs not shown here have no allocation.

² The factory default setting is shown in bold.

³ After the cooktop has been switched on, *dE* appears in the timer display for several seconds.

⁴ In the text and charts, the intermediate levels are shown with a dot after the number for better understanding.

⁵ The confirmation tone of the On/Off sensor control cannot be switched off.

Cleaning and care

Safety notes on cleaning and care

 Danger of burning due to hot surfaces.

All parts of the cooktop may be hot after use.

Turn off the cooktop.

Allow the cooktop to cool down before cleaning it.

All surfaces could be discolored or damaged if unsuitable cleaning agents are used or if residues from suitable cleaning agents are heated on the cooktop. All surfaces are susceptible to scratching.

Allow the surfaces to cool down before cleaning the cooktop.

Remove any residual cleaning agent immediately.

Do not clean with any abrasive cleaning agents or sharp pointed objects.

▶ Do not use a steam cleaner to clean the cooktop.

▶ Do not use pointed objects for cleaning.

When to clean

- Before every use:
Clean the entire cooktop and the base of the cookware.
- After every use:
Clean the entire cooktop.

- Once a week:
To prevent cleaning agent residue being burned on, clean the glass-ceramic surface with the Miele ceramic and stainless steel cleaner (see “Optional accessories – Cleaning and care products”) or with a proprietary glass-ceramic cleaner. Please follow the cleaning agent manufacturer’s instructions.

Cleaning the glass-ceramic surfaces

Removing light soiling

- Clean the entire glass-ceramic surface of the cooktop with a damp, soft all-purpose cloth, and a solution of water and a little liquid dish soap. Please follow the cleaning agent manufacturer’s instructions.

Removing stubborn soiling

- First wipe down the surface with a damp cloth to loosen soiling, then remove stubborn crusting with a glass scraper.
- Clean the glass-ceramic surface with the Miele ceramic and stainless steel cleaner (see “Optional accessories – Cleaning and care products”) or with a proprietary glass-ceramic cleaner. Please follow the cleaning agent manufacturer’s instructions.

Finishing the cleaning process

- Remove all cleaning agent residues with a damp cleaning cloth.
- Dry the glass-ceramic surface of the cooktop after cleaning.

Unsuitable cleaning agents

To avoid damaging the surfaces of the appliance, do not use:

- cleaning agents containing soda, alkalis, ammonia, acids, or chlorides
- stain or rust removers
- abrasive cleaning agents, such as scouring powder, scouring liquid, or pumice stones
- cleaning agents containing solvents
- dishwasher cleaning agents
- grill and oven sprays
- hard, abrasive brushes
- eraser sponges
- sponges

Frequently asked questions

Many malfunctions and faults can be easily remedied. You can save time and money in many cases, as you do not need to contact Miele Service.

More information to help you rectify faults yourself can be found at <https://www.mieleusa.com/support/customer-assistance>.



Messages in the display

Problem	Possible cause and solution
<i>Err</i> flashes alternately with 30 in the timer display and a signal sounds.	The cooktop is incorrectly connected. <ul style="list-style-type: none"> ■ Disconnect the cooktop from the electrical power supply. ■ Contact Miele Service. The cooktop must be connected to the power supply according to the wiring diagram.
After turning on the cooktop or touching a sensor, the timer display shows LOC for a few seconds.	The system lock is activated. <ul style="list-style-type: none"> ■ Deactivate the system lock.
	The safety lock is activated. <ul style="list-style-type: none"> ■ Deactivate the safety lock.
After the cooktop has been switched on, dE appears briefly in the timer display. The cooking zones do not heat up.	The cooktop is in demo mode. <ul style="list-style-type: none"> ■ Press the 0 sensor control on any numerical display. ■ Then touch the 0 and 2 sensor controls at the same time until dE flashes alternately with OFF in the timer display.
The cooktop has switched off automatically. When the cooktop is turned back on, L appears above ① On/Off.	One or more of the sensor controls are covered, e.g., by finger contact, food boiling over, or an object. <ul style="list-style-type: none"> ■ Remove the soiling and/or the object.
<i>Err</i> will flash alternately with 044 in the timer display.	Overheating protection has been triggered. <ul style="list-style-type: none"> ■ Allow the cooktop to cool down. ■ Rectify the causes of the overheating (see “Overview – Overheating protection”). ■ Check that the cooktop works. ■ If this fault message continues to appear in the display, contact Miele Customer Service.

Frequently asked questions

Problem	Possible cause and solution
Err will flash alternately with <i>047, 048, or 049</i> in the timer display.	The fan is blocked or defective. <ul style="list-style-type: none"> ■ Make sure it has not been blocked by an object. ■ Remove the obstruction. ■ If this fault message continues to appear in the display, contact Miele Customer Service.
In the timer display, an E-number such as E-0 flashes alternately with <i>120, 121, 122, 123, 124, 125, 126, or 127</i> .	The fan is blocked or defective. <ul style="list-style-type: none"> ■ Make sure it has not been blocked by an object. ■ Remove the obstruction. ■ If this fault message continues to appear in the display, contact Miele Service.
A message not listed in this table is appearing in the timer display.	There is an electronic fault. <ul style="list-style-type: none"> ■ Disconnect the power supply to the cooktop for approx. 1 minute. ■ If the problem persists after the power supply has been restored, please contact Miele Service.

Unexpected behavior

Problem	Possible cause and solution
The U symbol lights up or flashes alternately with the set power level or P in one of the cooking zone indicators.	No cookware is present on the cooking zone. Unsuitable cookware is present on the cooking zone. The base diameter of the cookware used is too small. Suitable cookware has been removed from the cooking zone. If no cookware or unsuitable cookware is used, the cooking zone will automatically turn off after 15 seconds. <ul style="list-style-type: none"> ■ Place a suitable item of cookware on the cooking zone within 15 seconds. U will go out. The cooking process starts/continues with the previously selected settings. <ul style="list-style-type: none"> ■ If you are using a different item of cookware and/or food, modify the settings.
Power level 9 is automatically reduced if you also set power level 9 for the connected cooking zone.	Operating both zones at power level 9 exceeds the permitted maximum power for the two zones. <ul style="list-style-type: none"> ■ Use a different cooking zone.

Frequently asked questions

Problem	Possible cause and solution
A cooking zone or the whole cooktop switches off automatically.	It might have been operated for too long. ■ Switch the cooktop or the cooking zone back on (see “Overview – Safety shut-off”).
	Overheating protection has been triggered. ■ Allow the cooktop to cool down. ■ Rectify the causes of the overheating (see “Overview – Overheating protection”). ■ Check that the cooktop works. ■ If the problem occurs again, contact Customer Service.
The cooking zone is not working in the usual way with the set power level.	Overheating protection has been triggered. ■ Allow the cooktop to cool down. ■ Rectify the causes of the overheating (see “Overview – Overheating protection”). ■ Check that the cooktop works. ■ If the problem occurs again, contact Customer Service.
The Booster level has automatically turned off early.	Overheating protection has been triggered. ■ Allow the cooktop to cool down. ■ Rectify the causes of the overheating (see “Overview – Overheating protection”). ■ Check that the cooktop works. ■ If the problem occurs again, contact Customer Service.

Unsatisfactory results

Problem	Possible cause and solution
Auto Heat-up is turned on, but the food does not start cooking.	Large amounts of food are being heated. ■ Start cooking at the highest power level, then reduce the power level manually.
	The pan is not conducting heat properly. ■ Use a different pan that is able to better conduct heat on an induction cooktop.

Frequently asked questions

General problems or technical faults

Problem	Possible cause and solution
Cooktop or cooking zones cannot be switched on.	<p>There is no power to the cooktop.</p> <ul style="list-style-type: none">■ Check if the breaker has tripped. Contact a qualified electrician or Miele Customer Service (for the minimum fuse rating, see the data plate). <p>There may be a technical fault.</p> <ul style="list-style-type: none">■ Disconnect the cooktop from the electricity supply for approx. 1 minute by<ul style="list-style-type: none">– tripping the relevant breaker or unscrewing the fuse completely, or– switching off the residual current device.■ If the cooktop will still not switch on after the fuse or the residual current device has been reset/replaced, contact a qualified electrician or Customer Service.
Odors and vapors are given off when the new cooktop is used.	<p>The metal components have a protective coating. When the cooktop is used for the first time, this causes a smell and possibly also vapor. The material from which the induction coils are made also gives off a smell in the first few hours of operation. With each subsequent use, the odors are reduced until they disappear completely. The smell and any vapors do not indicate a faulty connection or a faulty appliance and are not harmful to your health.</p>
An operating noise can be heard after the cooktop has been switched off.	<p>The fan will continue running until the cooktop has cooled down. It will then turn itself off automatically.</p>

Miele Service

Information to help you rectify faults yourself and about Miele spare parts can be found at www.miele.com/service.

Contact in the event of a fault

In the event of a fault which you cannot remedy yourself, please contact your Miele dealer or Miele Customer Service.

You can book a Miele Service call online at www.miele.com/service.

Contact information for Miele Customer Service can be found at the end of this document.

Please quote the model identifier and serial number of your appliance (SN) when contacting Miele Customer Service. These can be found on the data plate or see “Operation – Cooktop data”.

Data plate

Adhere the extra data plate supplied with the appliance in the space below. Make sure that the model number matches the one specified on the back cover of this document.

Appliance warranty and product registration

You can register your product and/or view the manufacturer’s warranty terms and conditions for Miele appliances and vacuum cleaners at www.mieleusa.com.

Ordering a printed copy of the operating instructions

You can order a printed copy of the comprehensive operating instructions from Miele free of charge.

All the contact information you need for Miele can be found at the end of this document. Quote the model number and the serial number from the data plate when placing your order.

Declaration of conformity

Supplier's Declaration of Conformity 47 CFR § 2.1077 Compliance Information

Induction Cooktop

Unique Identifier: Miele Model: KM7720; KM7730; KM7740

Responsible Party

Miele, Inc.

National Headquarters

9 Independence Way

Princeton, NJ 08540

Phone: 800-843-7232

Fax: 609-419-4298

www.mieleusa.com

FCC Compliance Statement: This device complies with Part 18 of the FCC Rules.

IC Compliance Statement: This device complies with

CAN ICES-001 (B) / NMB-001 (B)

Radio Modules

This device contains the following WiFi module:

FCC ID	2ACUWEK037
IC ID	5669C-EK37
Frequency band	2.412 GHz – 2.462 GHz
Maximum transmitting power	< 0.1 W

Compliance Statement

This device complies with Part 15 of the FCC Rules and contains licence-exempt transmitter(s)/receiver(s) that comply with Innovation, Science and Economic Development Canada's licence-exempt RSS Standard(s).

Operation is subject to the following two conditions:

- (1) this device may not cause harmful interference, and
- (2) this device must accept any interference received, including interference that may cause undesired operation.

The construction of the device assures that the FCC/IC exposure limits are verifiably met using the integrated radio module.

Warning!

Any changes or modifications to this unit not expressly approved by the party responsible for compliance could void the user's authority to operate the equipment.

Please have the model and serial number
of your appliance available when
contacting Customer Service.

U.S.A.

Miele, Inc.

National Headquarters

9 Independence Way
Princeton, NJ 08540
www.mieleusa.com

Customer Support

Phone: 888-99-MIELE (64353)
info@mieleusa.com

International Headquarters

Miele & Cie. KG
Carl-Miele-Straße 29
33332 Gütersloh
Germany

Canada

Importer
Miele Limited

Headquarters and Miele Centre

161 Four Valley Drive
Vaughan, ON L4K 4V8
www.miele.ca

Customer Care Centre

Phone: 1-800-565-6435
905-532-2272
contact@miele-support.ca

KM 7720 FR, KM 7730 FR, KM 7740 FR

en-US

M.-Nr. 12 155 090 / 05