









Operating and installation Instructions Commercial Washing Machine PWM 511

It is **essential** to read these operating instructions before installing and using the appliance. This prevents both personal injury and damage to the appliance.

en-AU, NZ

Contents

Caring for the environment	6
Disposing of your old appliance	6
Warning and Safety instructions	7
Explanation of the safety notes and warnings on the machine	7
Correct application.....	8
Preventing problems	9
Technical safety	10
Correct use.....	12
Chlorine and component damage.....	14
Accessories	15
Disposing of your old appliance	15
Guide to the machine	16
Guide to the machine	16
Control panel.....	17
Operation	18
Sensors and touch display	18
Main menu	18
Examples of how to operate the machine	19
Operating the laundrette version	22
Washing	23
Preparing for use	23
Loading and switching on the washing machine	24
Loading the washing machine	24
Washing with dispenser drawer.....	26
Adding detergent using the dispenser drawer.....	26
Adding fabric softener or liquid starch separately	26
Adding starch separately	26
Selecting a programme	28
Selecting programme settings	29
Selecting Extras	32
Pre-wash 	32
Soak 	32
Rinse plus 	32
Rinse hold 	32
Filling stop 	32
Intensive 	32
Water plus 	32
Programme start – programme end	33
Timer	33
Special features in the programme sequence	35
Spin.....	35
Anti-crease	35
Changing the programme sequence	36
Changing a programme	36
Altering the wash programme.....	36
Interrupting a programme	36
Switching on the washing machine after a power failure	36
Adding or removing laundry	38

Problem solving guide	39
Problem solving guide.....	39
Customer Service.....	40
Problem solving guide.....	40
The programme does not start.....	40
Programme cancellation and fault message	41
There is a message in the display	41
Insufficient wash results	42
General problems with the washing machine.....	42
The door will not open or close	43
Opening the door in the event of a blocked drain outlet and/or power cut.....	44
Cleaning and care	47
Build-up of rust.....	47
Cleaning the detergent drawers, detergent compartments and siphons	48
Cleaning the water inlet filters.....	49
Installation	51
Installing the washing machine	51
Securing the machine	51
General operating conditions	51
For easy maintenance.....	52
PWM 511	52
Installing the washing machine	53
Installation on a raised plinth.....	53
Transit bars	54
Levelling the machine	56
Plumbing.....	57
Use of backflow prevention devices	57
Hot water connection	58
Cold water connection.....	58
Electrical connection	60
Reference to external appliances	60
Optional accessories	60
Connector Box	60
Wi-Fi/LAN interface.....	62
Plinth (APWM037/038/039)	62
Supervisor level	63
Opening the Supervisor level.....	63
Opening the supervisor level (self-service)	63
Code-based access	63
Changing the code	63
Closing the Settings menu.....	63

Contents

Controls / Display.....	64
Language.....	64
Language entry.....	64
Set languages.....	64
Time.....	65
Date.....	65
Logo.....	65
Start screen.....	65
Mode.....	65
Display brightness.....	65
“Display off” status.....	65
“Machine off” status.....	65
Volume.....	66
Visibility parameters.....	66
Delay start.....	66
Memory.....	66
Measuring system.....	66
Supervisor code.....	66
Wi-Fi.....	66
Programme selection.....	67
Controls.....	67
Programme packages.....	67
Favourite programmes.....	67
Moving programmes.....	67
Prog. colour allocation.....	68
Expert code.....	68
Process technology.....	69
Anti-crease.....	69
Automatic drainage.....	70
Service.....	70
Service interval.....	70
External applications.....	70
Payment system lock.....	70
Connector box.....	70
Automatic dispensing.....	70
Dispensing.....	70
Peak load prevention.....	71
Machine parameters.....	71
Maximum spin speed.....	71
Max. possible temperature.....	71
Legal information.....	71
Networking.....	72
Pairing instructions.....	72
Network connection.....	72
Opening the Supervisor level.....	72
Initial network setup.....	72
Setting up a network connection manually.....	73
Establishing the network connection via WPS.....	74
Establishing the network connection via soft AP.....	75
Establishing the network connection using a LAN cable.....	75
Wi-Fi/LAN interface configured.....	76

Technical data	76
Technical data	78
PWM 511 machine data	78
Electrical connection.....	78
PWM 511 installation dimensions.....	78
Weight and floor load.....	78
Emissions data.....	78
Wi-Fi	78
Product safety.....	79
Wi-Fi data protection	80
Data protection and data security	80
Factory default settings for network configuration	80
Copyright and licences	80

Caring for the environment

Disposal of the packing material

The packaging is designed to protect the washing machine from damage during transportation. The packaging materials used are selected from materials which are environmentally friendly for disposal and should be recycled.

Recycling the packaging reduces the use of raw materials in the manufacturing process and also reduces the amount of waste in landfill sites. Ensure that any plastic wrappings, bags etc. are disposed of safely and kept out of the reach of babies and young children. Danger of suffocation!

Disposing of your old appliance

Electrical and electronic appliances often contain valuable materials. However, they also contain harmful substances which were essential for their correct functioning and safety. These could be hazardous to human health and to the environment if disposed of with general waste or if handled incorrectly. Please do not, therefore, dispose of your old appliance with general waste.

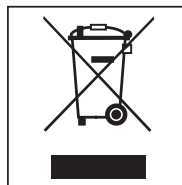

Please dispose of it at your local waste collection / recycling centre for electrical and electronic appliances. Please ensure that your old appliance presents no danger to children while being stored awaiting disposal.

Energy saving tips

Energy and water consumption

- To get the most out of your machine, load the **maximum** dry load size for the wash programme you are using. The most efficient use of energy and water is achieved when a full load is washed.
- If suitable, use programmes from the ECO programme package. The programmes are characterised by particularly low energy consumption.

Detergent

- Do not exceed the amounts of detergent recommended by the manufacturer on the packaging.
- Reduce the amount of detergent for smaller load sizes.





When drying the laundry in a tumble dryer

Select the highest possible spin speed for the wash programme to save energy in the subsequent tumble dryer cycle.

Warning and Safety instructions

Original operating instructions

Explanation of the safety notes and warnings on the machine

	Read the operating instructions
	Warning: hot surfaces
	Warning: voltage up to 1000 volts
	Protective earth
	Equipotential bonding

This washing machine complies with all current local and national safety requirements. However, inappropriate use can lead to personal injury and damage to property.

Read the operating instructions carefully before using the washing machine. They contain important information on safety, installation, use and maintenance. This prevents both personal injury and damage to the washing machine.

Miele expressly and strongly advises that you read and follow the instructions in the chapter on installing the washing machine as well as the warning and safety instructions.

Miele cannot be held liable for injury or damage caused by non-compliance with these instructions.

Keep these operating instructions in a safe place and pass them on to any future owner.

When instructing other people how to use the washing machine, they must be made aware of these warning and safety instructions.

Warning and Safety instructions

Correct application

- ▶ The washing machine is only suitable for washing fabrics with a care label stating that they are suitable for machine washing. Any other applications may be dangerous. The manufacturer cannot be held liable for damage resulting from incorrect or improper use or operation of the machine.
- ▶ This washing machine must be used as described in the operating instructions and must be checked on a regular basis to make sure it is functioning correctly. Maintenance must be carried out when necessary.
- ▶ The washing machine is not suitable for outdoor use.
- ▶ Do not install the washing machine in a room where there is a risk of frost. Frozen hoses can tear or burst. The reliability of the electronic control unit may be impaired at temperatures below freezing point.
- ▶ The washing machine is designed for commercial use only.
- ▶ If the machine is used in a commercial environment, it may only be operated by instructed/trained personnel. If the machine is to be operated in an area accessible to the public, the supervisor must ensure that it can be operated safely without risk of danger to others.
- ▶ The machine must not be installed and operated in mobile locations (e.g. on a ship).
- ▶ This washing machine is not intended for use by persons (including children) with reduced physical, sensory or mental capabilities, or lack of experience and knowledge, unless they have been given supervision or instruction concerning its use by a person responsible for their safety.
- ▶ Young children must not be allowed to use this appliance.
- ▶ Older children may only use the appliance when its operation has been clearly explained to them and they are able to use it safely. They must be able to understand and recognise the possible dangers of misuse.
- ▶ Cleaning or maintenance on the washing machine may only be carried out by older children under the supervision of an adult.
- ▶ Always supervise any children in the vicinity of the washing machine. Never allow children to play with the washing machine.
- ▶ Disinfection programmes must not be interrupted, as this can have a limiting effect on the disinfection result. It is the operator's responsibility to ensure that the standard of disinfection in thermal as well as chemo-thermal procedures is maintained by carrying out suitable validation tests.

Preventing problems

▶ Never use solvent-based detergents, e.g. those containing benzene, in this washing machine. This may result in damage to component parts and create toxic fumes. **Risk of fire and explosion!**

▶ When washing with high temperatures, remember that the porthole glass becomes hot. Therefore, prevent children from touching the porthole glass during the wash process.

Danger of burning!

▶ Close the drum door after each wash programme. This is to avoid the risk of children trying to climb into the washing machine or hiding things in it, and animals getting into the machine.

▶ Do not damage, remove or bypass the safety components or control elements of the washing machine.

▶ Machines with damaged control elements or cable insulation may only be replaced by the manufacturer/Miele Professional Service or a qualified electrician.

▶ If the supply cord is damaged, it must be replaced by the manufacturer, its service agent or similar qualified person in order to avoid a hazard.

▶ The water generated during washing is suds solution and not drinking water. Drain the suds solution into a proper drainage system.

▶ Always make sure that the drum is stationary before reaching in to remove laundry. Reaching into a moving drum is extremely dangerous and may result in injury.

▶ Be careful not to put your hands in the gap between door and frame when closing the drum door.

Please note: the drum door is locked automatically as soon as the washing machine starts.

▶ It is particularly important to observe the manufacturer's instructions when using a combination of cleaning agents and special application products. Products must only be used for applications approved by the manufacturer to avoid any material damage or the occurrence of strong chemical reactions.

Warning and Safety instructions

Technical safety

- ▶ Before installing and operating the washing machine, check it for any visible exterior damage. Do not install or operate a damaged washing machine.
- ▶ The electrical safety of this washing machine can only be guaranteed when continuity is complete between it and an effective earthing system which complies with current local and national safety regulations. It is most important that this basic safety requirement is present and regularly tested and, where there is any doubt, the on-site wiring system should be inspected by a qualified electrician. Miele cannot be held liable for the consequences of an inadequate earthing system (e.g. electric shock).
- ▶ Unauthorised repairs could result in unforeseen dangers for the user, for which the manufacturer cannot accept liability. Repairs must only be carried out by a Miele authorised service technician, otherwise any subsequent damage will not be covered by the warranty.
- ▶ Do not make any alterations to the machine, unless authorised to do so by Miele.
- ▶ The washing machine must be disconnected from the mains electricity supply before any maintenance, cleaning or repair work is carried out. The washing machine is only isolated from the electricity supply when
 - it is switched off at the wall socket and the plug is withdrawn, or
 - the mains fuse is disconnected, or
 - it is switched off at the mains circuit breaker.

For more information, see "Installation – Electrical connection".

- ▶ The washing machine may only be connected to the water supply using the new hose set supplied with the machine. Old hoses must not be re-used. Check the hoses regularly for signs of wear. Change the hoses in good time to avoid the risk of leaks and water damage. The water flow pressure must be at least 100 kPa and must not exceed 1000 kPa.
- ▶ If leakages occur, remedy their cause before operating the washing machine again. Immediately disconnect the washing machine from the electricity supply when leaking occurs.
- ▶ Faulty components must only be replaced by genuine Miele original spare parts. Miele can only guarantee the safety standards of the machine when Miele replacement parts are used.
- ▶ Please observe the instructions in "Installation and connection" and "Technical data".
- ▶ If the washing machine is connected using a mains plug, the mains plug must always be kept accessible so that the washing machine can be easily disconnected from the power supply.
- ▶ For hard-wired machines, an all-pole means of deactivation must be provided on site. The means for disconnection must be incorporated in the fixed wiring in accordance with the wiring rules, AS/NZS 3000.

Warning and Safety instructions

- ▶ If the washing machine is hard wired, provision must be made on site to switch off all poles from the electricity supply. The means for disconnection must be incorporated in the fixed wiring in accordance with the wiring rules, AS/NZS 3000. The disconnection switch must be located in the immediate area around the washing machine, and must always be visible, accessible and easily reachable.
- ▶ For washing machine versions without a separate emergency stop switch, there must be a central emergency stop mechanism at the place of installation.

Warning and Safety instructions

Correct use

▶ The maximum dry laundry weight for the PW 511 is 11.0 kg. See the "Programme chart" for the maximum recommended loads for individual programmes.

▶ Before using the washing machine for the first time, ensure that the transport safety devices have been removed (see "Installation – Removing the transport safety devices"). If the transport safety devices are not removed, they may cause damage to adjacent furniture or machines during the spin cycle.

▶ Never try to open the drum door of the washing machine using force. The drum door can only be opened if appropriate information is shown in the display.

▶ Do not push the suspended drum unit while the machine is running.

▶ When closing the drum door there is a risk of injury between the door frame and drum opening, as well as at the hinges.

Caution: the drum door is locked automatically when the machine is started.

▶ Turn off the water inlet if the washing machine is to be left for any length of time (e.g. while on holiday), especially if there is no floor drain in the immediate vicinity.

▶ Make sure that no foreign objects (e.g. nails, pins, coins, paper clips) find their way into the machine with the laundry. Foreign objects can damage components of the machine (e.g. suds container, drum). Damaged components can, in turn, result in damage to the laundry.

▶ If the correct amount of detergent is dispensed, the machine should not need to be descaled. If, however, you do wish to descale your washing machine, only use proprietary non-corrosive descaling agents and strictly observe the instructions on the packaging. Special descaling agent is available from Miele. Strictly observe the instructions for the packaging.

▶ Fabrics that have been pre-treated in solvent-based cleaning agents must be thoroughly rinsed in clean water before being placed in the machine. Note that solvent residues may only be discharged into waste water in compliance with local legislation.

▶ Never use solvent-based detergents, e.g. those containing benzene, in this washing machine. This may result in damage to component parts and create toxic fumes. **Risk of fire and explosion!**

▶ Do not store or use petrol, paraffin or any easily flammable substances near the washing machine. Do not use the machine lid as storage space.

Risk of fire and explosion!

▶ Do not store chemicals (liquid detergents, additives) on the machine lid. They may cause discolouration or lacquer damage. Accidentally spilled chemicals should be removed from the surface immediately with a wet cloth.

▶ Only use dyes, dye removers, and descaling agents suitable for use in a washing machine. The manufacturer's instructions on the packaging must be observed.

▶ Dye removers contain sulphur compounds which can cause damage such as corrosion. Dye removers must not be used in the washing machine.

Warning and Safety instructions

- ▶ Avoid contact between stainless steel surfaces and liquid detergents or disinfecting agents containing chlorine or sodium hypochlorite. These agents can cause corrosion on stainless steel. Aggressive chlorine bleach vapour can also cause corrosion. Do not store open containers of these agents near the appliance.
- ▶ Do not use a high-pressure cleaner or water jet to clean the washing machine.

Warning and Safety instructions

Chlorine and component damage

► Frequent use of chlorine products increases the risk of damage to components.

► The use of substances containing chlorine, such as sodium hypochlorite and chlorine bleach in powder form, can however result in damage to the protective layer of stainless steel and corrosion on components. Therefore, refrain from using agents containing chlorine. Use oxygen-based bleaching agents instead.

If, however, chlorine bleaching agents are used, an anti-chlorine treatment must always be carried out. Otherwise, the washing machine components and the load may suffer lasting and irreparable damage.

► Anti-chlorine treatment must be carried out immediately after chlorine bleach has been used. Hydrogen peroxide and oxygen-based detergents and bleaching agents are suitable for anti-chlorine treatment. The suds must not be drained in between.

Treatments with thiosulphates can result in gypsum-like deposits, particularly in combination with hard water. This gypsum can build up in the washing machine or cause incrustations on the laundry.

Treatment with hydrogen peroxide is recommended over treatment with thiosulphates because hydrogen peroxide neutralises chlorine.

The exact dispensing quantities and the treatment temperatures required must be set and tested on site in accordance with the dispensing recommendations of the detergent and additive manufacturers. The laundry must also be tested to check whether it contains any active chlorine residues.

Accessories

▶ Only use genuine Miele spare parts and accessories with this machine. Using spare parts or accessories from other manufacturers will invalidate the warranty, and Miele cannot accept liability.

Disposing of your old appliance

▶ Ensure that the door locks are unusable when disposing or scrapping old washing machines. This way you will prevent the risk of playing children accidentally locking themselves in and endangering their lives.

Miele cannot be held liable for damage caused by non-compliance with these Warning and Safety instructions.

Guide to the machine

Guide to the machine

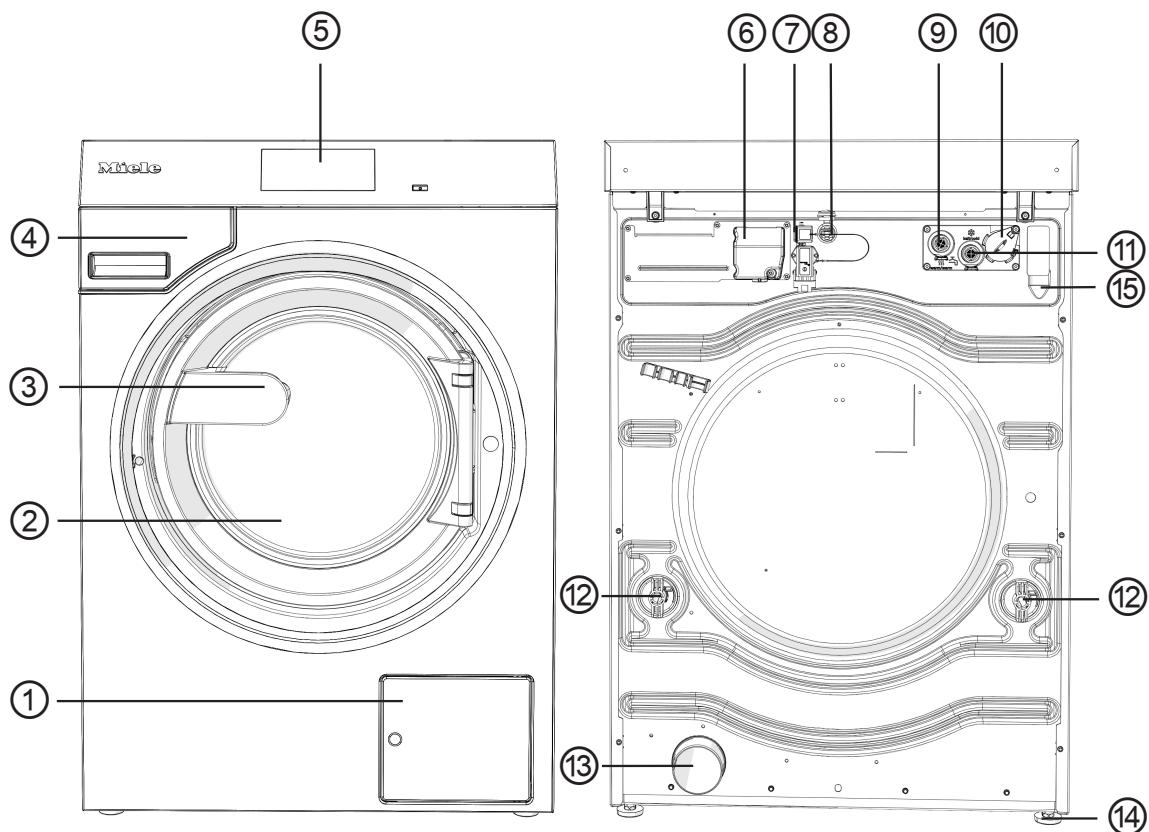

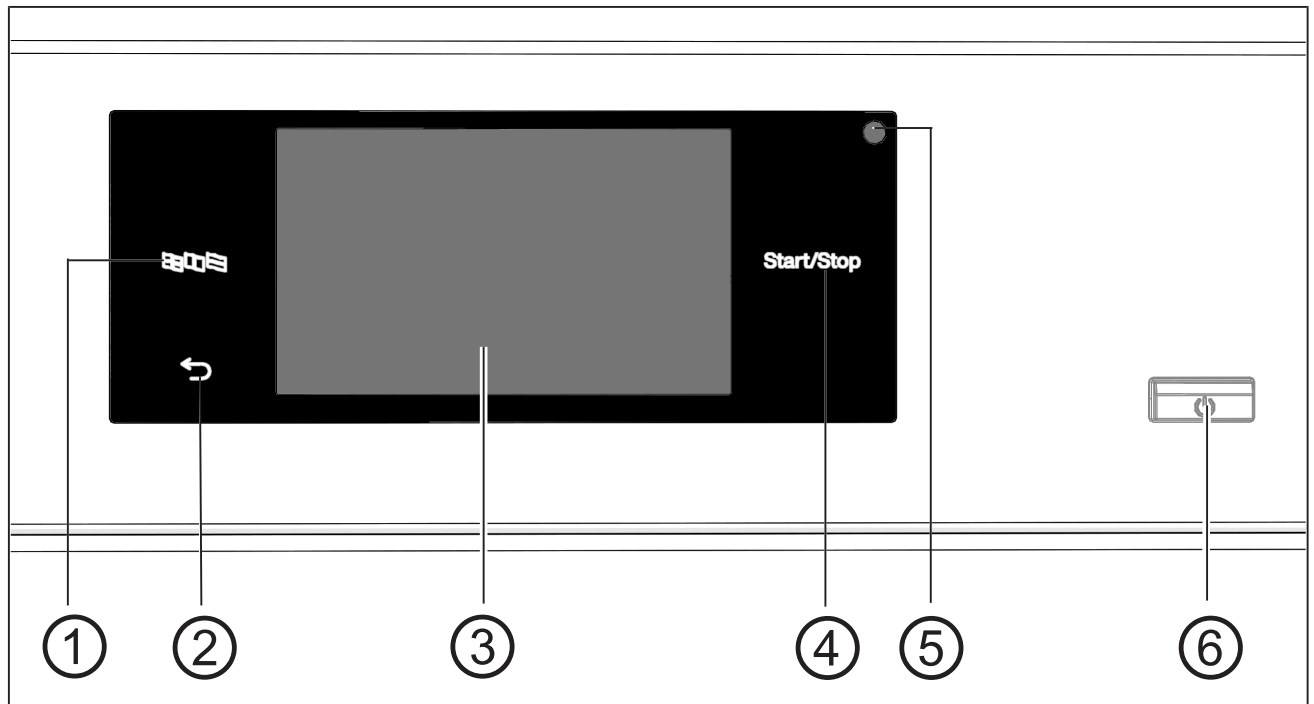

- ① Access to drain filter and drain pump or drain valve
- ② Drum door
- ③ Door handle
- ④ Detergent dispenser drawer
- ⑤ Display (further information can be found in "Operation")
- ⑥ Electrical connection
- ⑦ Interface for Connector Box (optional second interface)
- ⑧ LAN interface
- ⑨ Hot water connection
- ⑩ Interface for external dispensing
- ⑪ Cold water connection
- ⑫ Transit bars
- ⑬ Drain (DV version)
- ⑭ Four adjustable feet
- ⑮ Connection of waste water hose (LP version)

Control panel



- ① **language sensor**
For selecting the current user language. The operating language is displayed again at the end of the programme.
- ② **back sensor**
Takes you back one level in the menu.
- ③ **Touch display** with system-specific symbols
- ④ **Start/Stop sensor**
For starting the selected programme and cancelling a running programme. The programme selected can be started as soon as the sensor starts flashing.
- ⑤ **Optical interface**
For service technicians.
- ⑥ **button**
For switching the washing machine on and off.

Sensors and touch display

The sensors ,  and *Start/Stop* and the elements in the display respond to fingertip contact. Every touch of the sensors is confirmed by a keypad tone. You can adjust the volume of the keypad tone or switch it off (see “Supervisor level”).

The control panel with the sensors and the touch display can be scratched by pointed or sharp objects, e.g. pens.
Only touch the control panel with your fingers.

Main menu

After switching on the washing machine, the main menu will appear in the display.

You can access all important sub-menus from the main menu.

Touch the  symbol at any time to return to the main menu. Values that have not yet been confirmed are not saved when you return to the main menu.

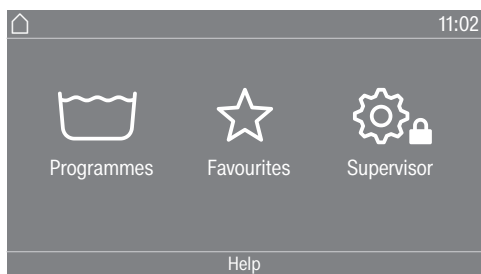

 Programmes” menu In this menu, you can select the wash programmes.

 Favourites” menu In this menu, you can select 1 favourite programme from a total of 24 favourite programmes. The wash programmes can be set up and saved by the supervisor in the *Favourites* menu (see “Supervisor level - Favourite programmes”).

 Supervisor” menu You can alter the washing machine’s user interface to suit changing requirements in the supervisor level (see “Supervisor level”).

Examples of how to operate the machine

Selection lists

"Programmes" menu (single selection)

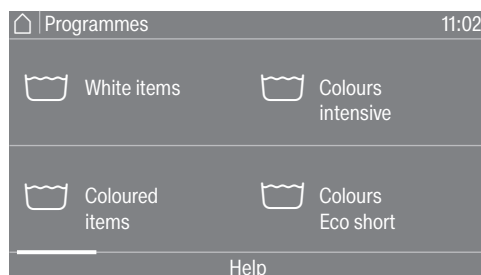

You can scroll to the right or the left by swiping your finger across the screen. To do this, place your finger on the touch display and swipe it in the direction you want.

The orange bar under the pictures shows that there are further options to choose from.

Touch a programme name to select a wash programme.

The display will change to the standard menu for that programme.

"Extras" menu (multiple selection)

In order to access Extras, you must first select a programme, e.g. White items.

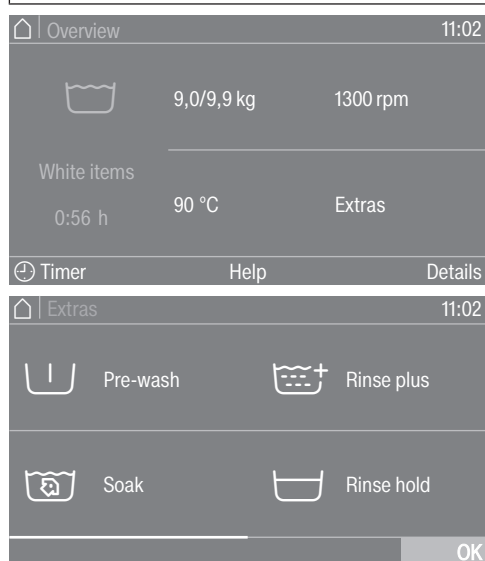

Touch one or several *Extras* to select it/them.

Currently selected *Extras* are marked orange.

To deselect an *Extra*, simply touch the *Extra* again.

Use the *OK* symbol to activate the selected *Extras*.

Operation

Setting numerical values

You can set numerical values in some menus.

The following example shows how to set the time of day. The “Supervisor level” section describes how to get to this level.

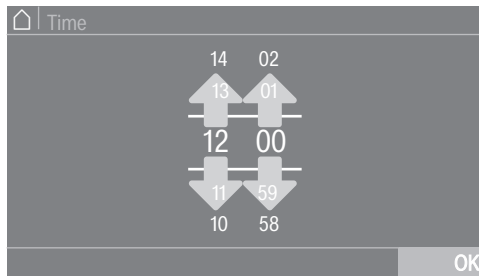

Enter the numbers by swiping upwards or downwards.

Place your finger on the number that you want to change and move your finger in the desired direction. Use the *OK* symbol to accept the set numerical value.

Useful tip: With some settings, a value can also be entered using a numerical keypad.

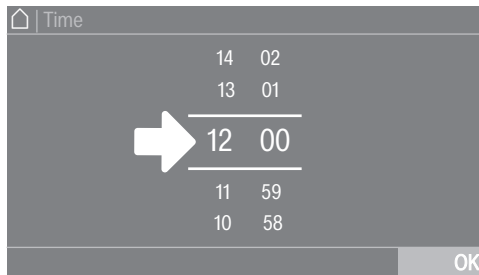

Briefly touching the number between the two lines will bring up the numerical keypad.

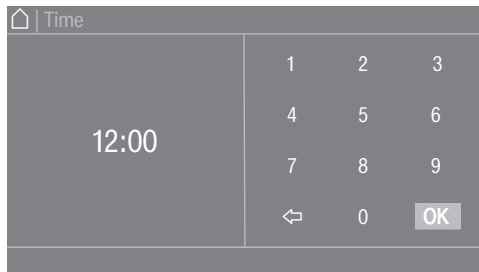

Once a valid number has been entered, the *OK* symbol will be highlighted green.

Pull-down menu

The following example describes the display for an ongoing wash programme. The “Programme start – Programme end” section describes how to get to this level.

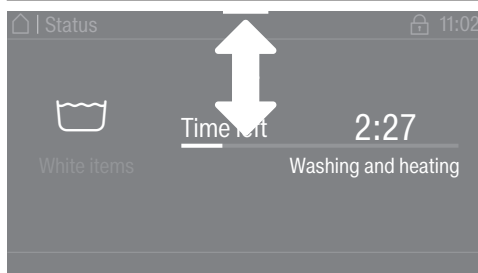

If an orange bar appears at the top of the screen in the middle of the display, you can open the pull-down menu. Touch the bar and drag it down with your finger on the display.

Exiting a menu

- Touch the ↶ symbol to return to the previous screen.

Entries you have made before this which have not yet been confirmed with *OK* will not be saved.

Help display

With some menus Help appears in the bottom line of the display.

- Touch the Help selection area to display these tips.
- Touch the Close selection area to return to the previous screen.

Operating the launderette version

The main menu will vary depending on the programming status (see “Supervisor level”).

Shortcuts are the easiest way to operate the machine. Operators cannot change the preset programmes.

Launderette, basic

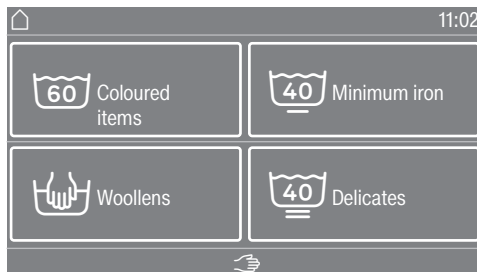

Between 4 and 24 preset programmes are available. These programmes cannot be changed by the operator.

Launderette logo

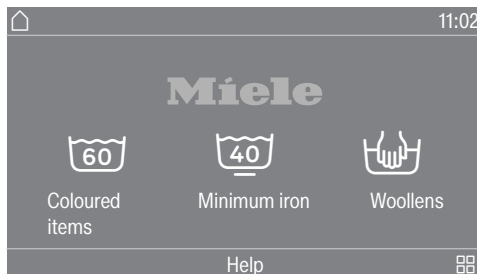

Up to 24 preset programmes are available. The first 3 programmes can be selected directly. The remaining programmes are selected from a list . These programmes cannot be changed by the operator.

Preparing for use

Emptying pockets

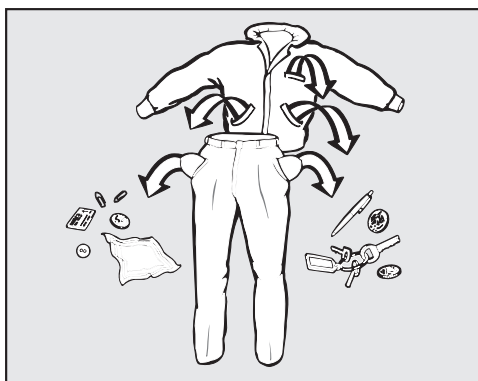

- Empty all pockets.



Damage due to foreign objects.

Foreign objects (e.g. nails, coins, paper clips etc.) can cause damage to garments and to components in the machine.

Check the laundry before washing and remove any foreign objects.

Sorting the laundry

Preparing mops, cleaning cloths, etc.

Pre-treating stains

General tips

- Sort the laundry by colour and by care label.
 - Shake mops, cleaning cloths, and pads out well to get rid of coarse soiling before placing them in the washing machine drum.
 - Clean badly soiled areas and stains on the textiles before washing. Stains should be carefully dabbed off using a soft, colourfast cloth.
- Do not wash any items in this machine which are specified by the manufacturer as not washable on the care label (☒ symbol).
 - Curtains: remove rollers and lead weights or place in a laundry bag.
 - Sew in or remove any loose underwiring in bras.
 - Turn garments inside out, if recommended by the manufacturer.
 - Close any zips and velcro fasteners before washing.
 - Fasten duvet covers and pillow cases to prevent small items from being rolled up inside them.
 - Please refer to the “Programme overview” for more tips.

Washing

Loading and switching on the washing machine

Loading the washing machine

- Prepare the washing machine.
- Switch on the washing machine with the  button. The welcome screen will light up.
- Pull the door handle to open the drum door.

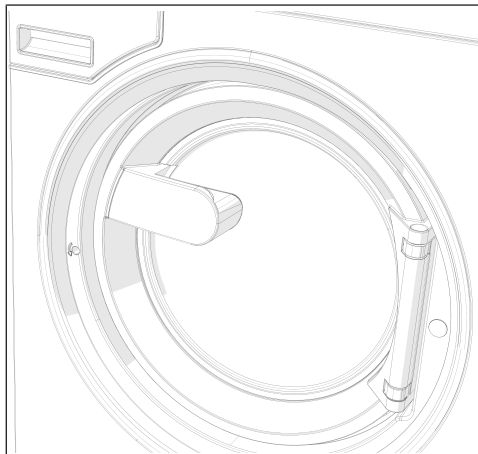

- Unfold the laundry and load loosely in the drum.

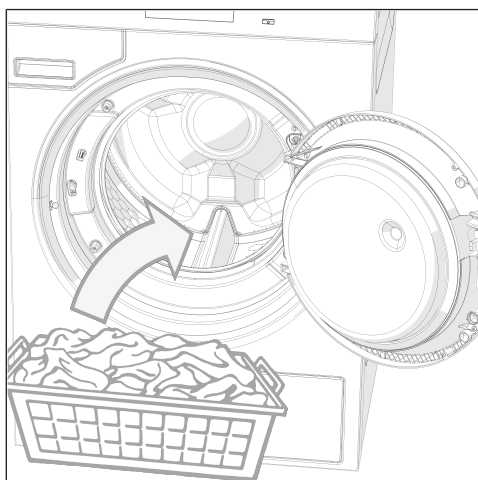

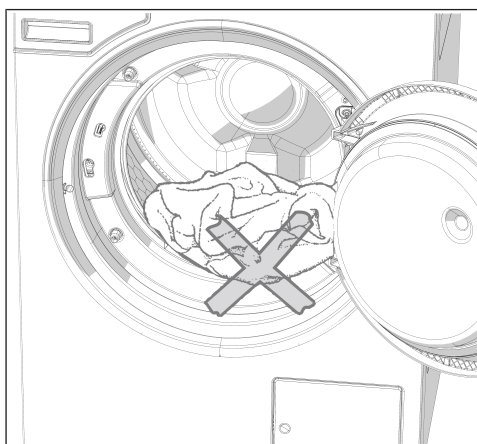

⚠ Make sure that no items are caught between the drum door and the opening.

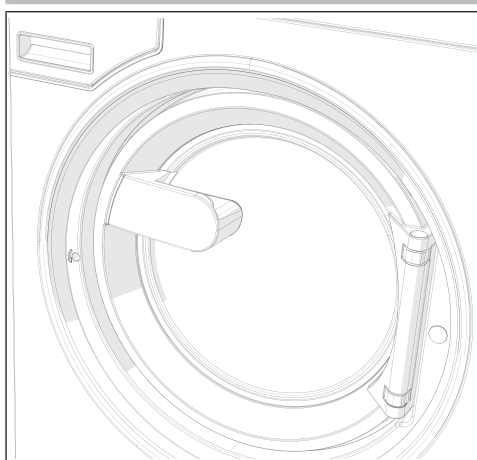

■ Close the door by pressing it until the pre-latch engages.

The drum door engages, but does not lock yet. The drum door locks automatically as soon as the machine starts.

Washing with dispenser drawer

Adding detergent using the dispenser drawer.

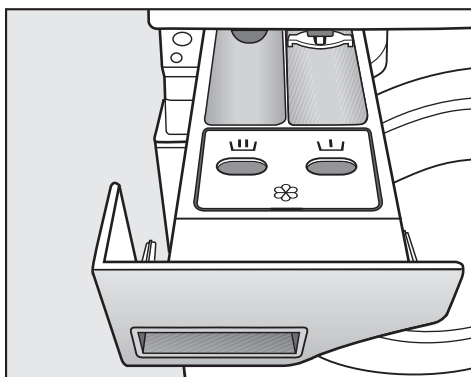

- For standard programmes, add powder detergent for the main wash to the **U** dispenser compartment. If required, add detergent for the pre-wash to the **U** dispenser compartment and add fabric softener to the **⊗** dispenser compartment.

Adding fabric softener or liquid starch separately

- Select the *Separate rinse* programme.
- Change the spin speed if necessary.

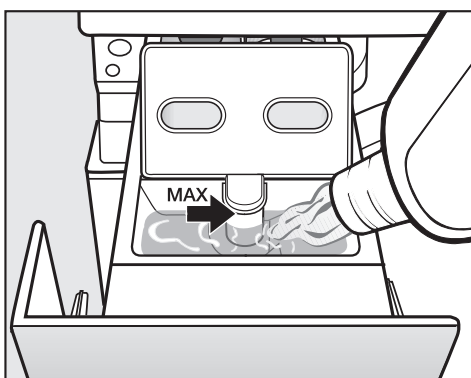

- Add fabric softener or liquid starch to the **⊗** compartment. **Do not exceed the maximum level mark.**
- Touch the *Start/Stop* sensor.

Adding starch separately

- Prepare the starch solution in accordance with the manufacturer's instructions on the packaging.
- Select the *Starch* programme.
- Add the prepared starch to the **U** compartment.
- Touch the *Start/Stop* sensor.

Useful tip: If starching separately or automatically, thoroughly clean the detergent drawer, especially the siphon, regularly.

Dyes, dye removers and descaling agents

Proprietary dyes, dye removers and descaling agents may only be used in this machine if the manufacturer expressly states that they are suitable for use in a washing machine. The manufacturer's instructions on the packaging must be observed.

Detergent dispensing

Avoid dispensing more than the required amount as this can cause excessive foaming.

- Only use low foaming detergents.
- Dispense according to the detergent manufacturer's recommendations.

The amount to dispense will depend on:

- the amount of laundry
- the water hardness
- the degree of soiling of the laundry

Amount of detergent

Please dispense according to water hardness levels and follow the detergent manufacturer's instructions.

Water hardness levels

Water hardness range	Hardness in mmol/l	German scale - °dH
soft (I)	0 - 1.5	0 - 8.4
medium (II)	1.5 - 2.5	8.4 - 14
hard (III)	above 2.5	above 14

Check with your local water supplier if you do not know the water hardness level in your area.

Selecting a programme

Programmes

There are different ways to select a programme.

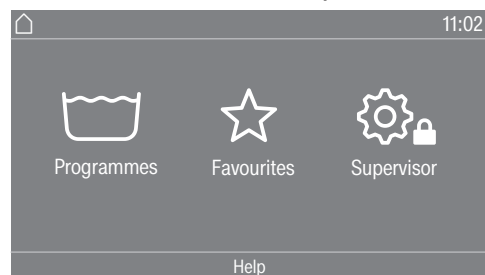

You can select a programme from the Programmes menu.

- Touch the Programmes selection area.

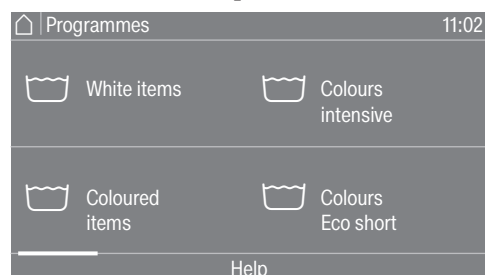

- Scroll to the right in the display until the programme you want appears.
- Touch the system-specific symbols in the touch display.

The display will change to the standard menu for that wash programme.

Favourites

Alternatively, you can select a programme from the Favourites menu.

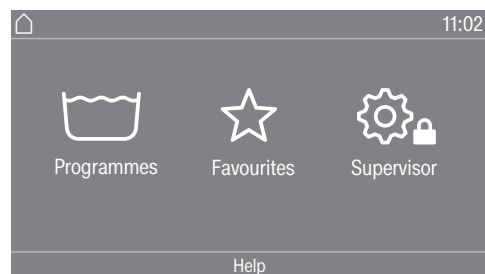

- Touch the Favourites selection area.

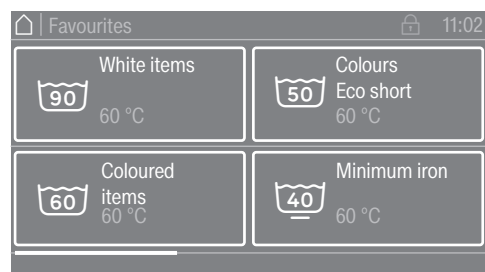

- Scroll to the right in the display until the programme you want appears.
- Touch the required wash programme symbol in the touch display.

The display will change to the standard menu for that wash programme.

With favourite programmes, the majority of the programme settings are preset and cannot be changed.

Selecting programme settings

Selecting a load size

To enable load specific dispensing and an adjusted programme sequence, you can specify the load size for some programmes.

- Touch the Weight (kg) selection area.

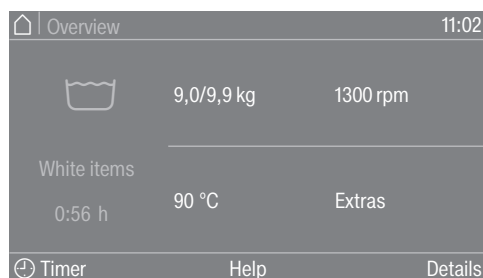

- Enter a valid value for the load size.

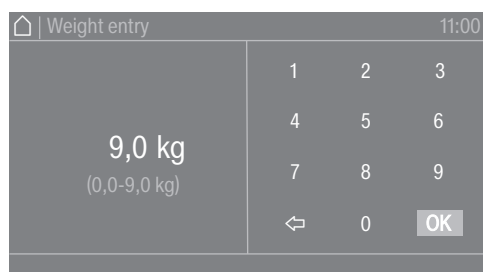

- Touch the OK symbol.

The display will change to show the Overview menu.

Washing

Selecting the temperature

You can alter the preset temperature of the wash programme.

- Touch the Temperature (°C) selection area.

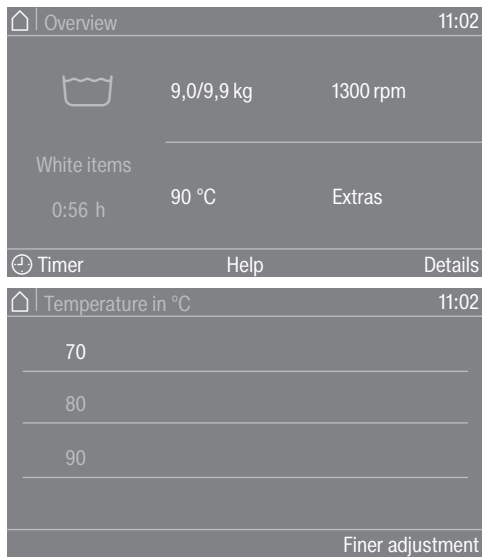

- Select the desired temperature from the pre-settings.

The display will change back to the Overview menu.

If you access the Finer adjustment selection area, you can set further temperatures using direct entry within the available temperature range.

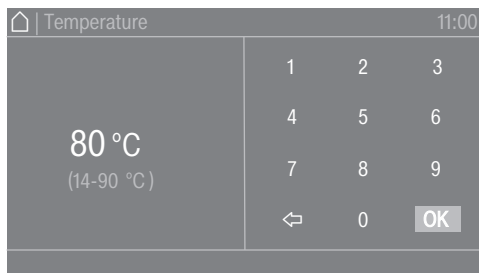

- Select the required value using the keypad.
- Touch the OK symbol.

The display will change back to the Overview menu.

The temperature can only be selected within the given range of the current setting, e.g. (14-90 °C).

Selecting a spin speed

You can alter the preset spin speed of the wash programme.

- Touch the Spin speed in rpm selection area.



- Select the desired spin speed from the pre-settings.

The display will change back to the Overview menu.

When you access the Finer adjustment selection area, you can set further spin speeds within the spin speed range.

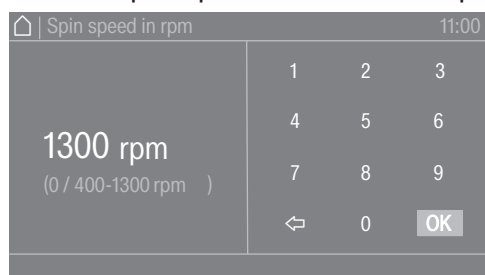

- Select the required value using the keypad.
- Touch the OK symbol.

The display will change back to the Overview menu.

The spin speed can only be selected within the given range of the current setting, e.g. (0 / 400-1300 rpm).

Selecting Extras

Selecting Extras

You can select Extras for some wash programmes.

- Touch the Extras selection area.

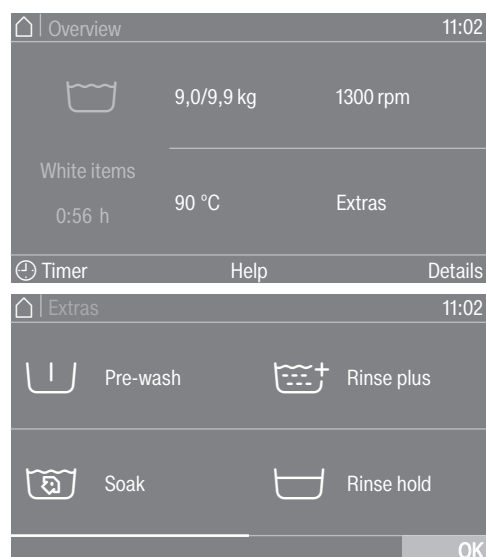

- Select one or more Extras.
- Touch the OK symbol.

The display will change to show the Overview menu.

Pre-wash

A pre-wash can be added for heavily soiled laundry. Coarse soiling is loosened and removed before the main wash.

Soak

For heavily soiled fabrics with protein stains. The soaking time is 10 minutes.

Rinse plus

An extra rinse can be activated to achieve a better wash result.

Rinse hold

The laundry is not spun after the final rinse and remains in the rinse water. This helps prevent creasing if the laundry is not going to be removed from the drum immediately after the end of the programme.

Filling stop

Water is drained out of the machine before the last rinse and the programme stops. The required starch, dye, proofing agent, etc. is added directly to the washing machine drum. The programme is continued by touching the *Start/Stop* sensor.

Intensive

For hard-wearing laundry that is very heavily soiled. The cleaning effect is increased by prolonging the main wash.

Water plus

The water level during washing is increased.

Programme start – programme end

Starting a programme

The programme can be started as soon as the *Start/Stop* sensor is flashing on and off.

- Touch the *Start/Stop* sensor.

The door will lock (🔒 symbol) and the wash programme will start.

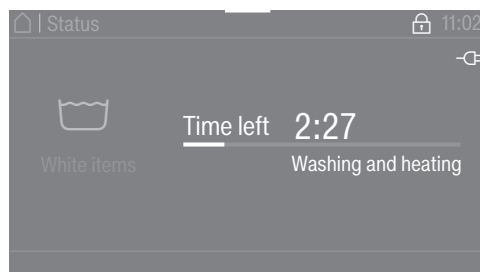

Useful tip: You can use the pull-down menu to display the selected temperature, spin speed and any selected Extras.

If a Delay start period has been selected, this will appear in the bottom-left of the display.

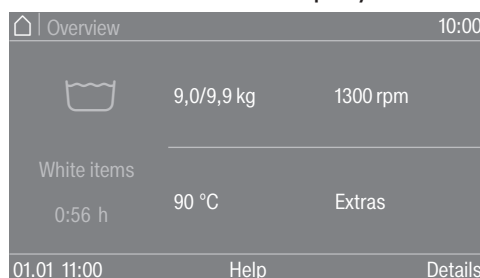

At the end of the Delay start time or immediately after the programme has started, the programme duration will appear in the display. The programme sequence is also shown in the display.

End of the programme

Depending on the selected setting in the supervisor level or programme, the machine changes to the Anti-crease phase at the end of the programme. The door remains locked. However, the door can be unlocked at any time by touching the *Start/Stop* sensor.

Removing the laundry

- Pull open the door.
- Remove the laundry.

Items left in the drum could discolour other items in the next wash or become discoloured themselves.
Remove all items from the drum.

- Check the door sealing ring for any foreign objects.
- Switch the washing machine off with the ⏻ button.

Useful tip: Leave the detergent dispenser drawer slightly open to allow it to dry.

Timer

The programme start date, programme start time and programme end time can be selected using the timer. This mode is also referred to as Delay start.

Setting the timer

- Touch the 🕒 Timer selection area.

Washing

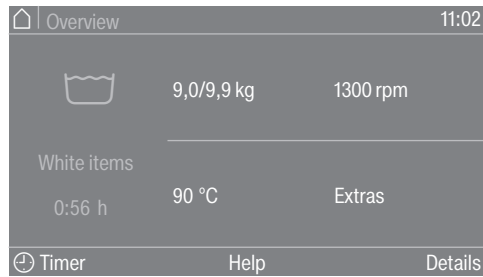

- Select the Finish at, Start date or Start at options.

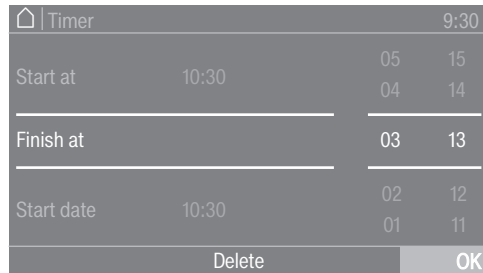

- Set the hours and the minutes or the date and confirm with the OK sensor.

Deleting the timer The selected Delay start time can be cancelled before the programme starts.

- Touch the selection area with the selected settings in the timer field, e.g. 01.01. 11:00.

The selected Delay start time will appear in the display.

- Touch the Delete selection area.
- Confirm with the OK symbol.

The selected Delay start time is deleted.

Starting the timer ■ Touch the *Start/Stop* sensor.

The door will lock and the time remaining until the programme starts will appear in the display.

After the programme has started, the selected time can only be changed or cancelled by interrupting the programme.

The programme can be started immediately at any time.

- Touch the Start immediately selection area.

Special features in the programme sequence

Spin

Final spin speed

After a programme is selected, the maximum spin speed for this wash programme is shown in the pre-start menu.

A reduction of the final spin speed is possible.

Depending on the programme, it may also be possible to increase the speed. The setting options are displayed when you tap the spin speed.

Rinse-spin

There is a spin cycle after the main wash and between the rinses. A reduction in the final spin speed will also reduce the rinse-spin speed accordingly.

Anti-crease

At the end of the programme, the drum continues to turn at intervals for up to 30 minutes to help prevent creasing.

The drum door cannot be opened until the programme has ended.

Anti-crease is programme-dependent. The option can be switched on or off in the supervisor level.

Changing the programme sequence

Changing a programme

Altering the wash programme

Before selecting a new programme, cancel the current programme and select a new one.

Interrupting a programme

You can cancel a wash programme at any time after it has started.

If the programme is locked, the payment programmes or the disinfection programmes can only be cancelled by entering a code.

- Touch the *Start/Stop* sensor.

The following will appear in the display:

- Programme stopped. Continue by pressing "Start/Stop".

The following will appear in the display:

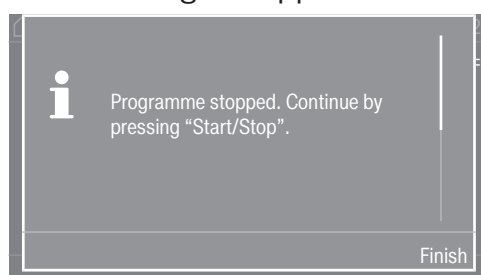

- Select Finish.

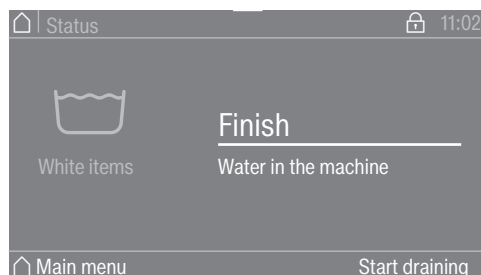

The suds are not drained so that they can be further used in a subsequent programme. After the programme has finished, the display for the programme end mask/programme end screen will appear. It is possible to change to the main menu with the suds in the machine or drain the suds by pressing the Start draining selection field. If permanent automatic water drainage is required, Automatic drainage can be activated at supervisor level.

The drum door remains closed while water is in the machine.

The door can be opened under the condition Programme end without water. If the temperature is too high, wait until it has cooled down so that the door can be opened.

- Wait until the door unlocks.
- Pull open the door.
- Remove the laundry.

Switching on the washing machine after a power failure

If the washing machine is switched off with the  button during a wash programme, the programme will be interrupted.

Changing the programme sequence

- Switch the washing machine back on with the  button.
- Note the message in the display.
- Touch the *Start/Stop* sensor.

The programme will continue.

Changing the programme sequence

Adding or removing laundry

You can add or remove laundry items for a short period immediately after the programme has started.

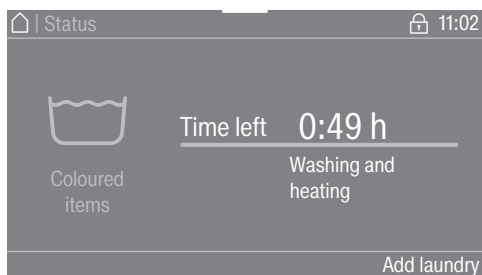

- Touch the Add laundry selection area.

If the message Add laundry is not visible in the display, then it is no longer possible to add items of laundry.

The wash programme will stop and the door will unlock.

⚠ Risk of chemical burns from detergent.
When adding or removing laundry during the main wash, your skin may come into contact with detergent, particularly if the detergent is dispensed externally.
Take care when placing your hands inside the drum.
If suds have come into contact with the skin, rinse off immediately with lukewarm water.

- Pull open the door.
- Add laundry or remove individual items.
- Close the door.
- Touch the *Start/Stop* sensor.

The wash programme will continue.

Problem solving guide

Opening the door in an emergency in case of a power cut

The drum door cannot be opened.

⚠ Warning! Danger from rotating drum and danger of scalding.
Before inserting the Torx wrench, make sure that the machine is disconnected from the electricity supply, the drum has stopped and there is no water in the machine.

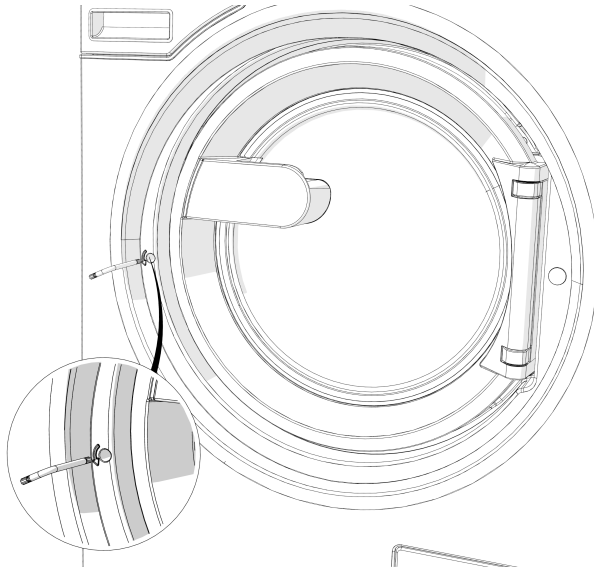

- Using a T 40 Torx wrench, turn the release element with the inner hexagon 2 whole revolutions **in the direction of the arrow**.

Useful tip: Pushing on the door at the same time makes it easier to turn the emergency release mechanism.

The release element is located opposite the door catch at the same height as the handle (see illustration).

The release element must not be turned against the direction of the arrow.
Danger of damage to the door lock.

The turn resistance will noticeably reduce. When the emergency release element moves freely, the door is unlocked.

Useful tip: It is not necessary to screw the emergency release element back in.

The door can now be opened.

Problem solving guide

Customer Service

Contact Miele Customer Service in the case of any faults.

When contacting the Miele Customer Service Department, please quote the model, serial number (SN) and material number (mat. no.) of your machine. This information can be found on the data plate. The data plate is visible above the door ring when the drum door is open, or on the back of the machine at the top:

Please also pass on the fault message appearing in the machine display to the Miele Customer Service Department.

Use only genuine Miele original spare parts. The Miele Customer Service Department will also require model, serial number (SN) and material number (mat. no.) when ordering.

Problem solving guide

With the help of the following guide, minor faults in the performance of the appliance, some of which may result from incorrect operation, can be remedied without contacting Miele. This will save you time and money because you will not need a service call.





Please note, however, that a call-out charge will be applied to unnecessary service visits where the problem could have been rectified as described in these operating instructions. You should, however, note the following:

 Repair work to electrical appliances must only be carried out by a suitably qualified technician in strict accordance with current local and national safety regulations. Unauthorised or incorrect repairs could cause personal injury or damage to the appliance.





The programme does not start

Problem	Possible cause and remedy
The display remains dark, and the <i>Start/Stop</i> sensor does not light up or flash.	There is no power to the washing machine. <ul style="list-style-type: none"> ■ Check whether the washing machine is switched on. ■ Check whether the washing machine is connected to the electricity supply. ■ Check whether the circuit breaker has tripped.
	The washing machine has switched off automatically to save energy. <ul style="list-style-type: none"> ■ Switch the washing machine back on with the  button.
The following appears in the display: F - Door lock fault. You can continue by pressing the "Start/Stop" button.	The door has failed to lock. <ul style="list-style-type: none"> ■ Close the door again. ■ Start the programme again. If the fault message appears again, contact Miele Professional Service.
The display is dark and the <i>Start/Stop</i> sensor is flashing slowly.	If the standby function has been activated at supervisor level, the display switches off automatically to save energy. <ul style="list-style-type: none"> ■ Touch any sensor. The display will switch on again.
The programme is in the pre-start screen and the <i>Start/Stop</i> sensor flashes.	The drum door is only ajar, but not correctly closed. <ul style="list-style-type: none"> ■ Check whether the drum door is closed correctly.

Programme cancellation and fault message

Problem	Possible cause and remedy
 F - Drainage fault. If machine restart is unsuccessful, call Miele.	<p>The drain is blocked or restricted. The drain hose has been fixed too high.</p> <ul style="list-style-type: none"> ■ Clean the drain filter and the drain pump. ■ The maximum delivery head is 1 m.
 F - Water intake fault. If machine restart is unsuccessful, call Miele.	<p>The water inlet is blocked or restricted.</p> <ul style="list-style-type: none"> ■ Check whether the water inlet is turned on properly. ■ Check the water inlet hoses for leaks. ■ Check whether the water connection pressure is sufficient. ■ Check whether the water inlet hoses are kinked.
	<p>The water inlet filters are blocked.</p> <ul style="list-style-type: none"> ■ Clean the filters.
 Disinfection temperature not reached	<p>The required temperature was not reached during the disinfection programme.</p> <ul style="list-style-type: none"> ■ The washing machine has not carried out the disinfection cycle correctly. ■ Restart the programme.
 Fault F. If restart fails, call Miele.	<p>There may be a fault.</p> <ul style="list-style-type: none"> ■ Disconnect the washing machine from the electricity supply. ■ Wait at least 2 minutes before reconnecting the washing machine to the electricity supply. ■ Then switch the washing machine on again. ■ Restart the programme. If the fault message appears again, contact Miele Professional Service.

There is a message in the display

Problem	Possible cause and remedy
 Container empty	<p>One of the liquid dispensing detergent containers is empty.</p> <ul style="list-style-type: none"> ■ Refill the detergent containers.
 Hygiene info: run a programme of at least 60°C	<p>During the last wash, a wash programme with a temperature below 60 °C was selected.</p> <ul style="list-style-type: none"> ■ Start a programme with a minimum temperature of 60 °C or the Clean machine Extras Intensive programme.
 F - Water intake fault. If machine restart is unsuccessful, call Miele.	<p>The hot water supply is blocked or restricted.</p> <ul style="list-style-type: none"> ■ Check whether the hot water supply has been turned on properly. ■ Check whether the inlet hose is kinked.
 Laundry not properly spun.	<p>The selected spin speed was not reached during the final spin due to excessive imbalance.</p> <ul style="list-style-type: none"> ■ Check that the washing machine is standing level. ■ Start the spin cycle again.

Problem solving guide



Problem	Possible cause and remedy
i Machine is leaking	The washing machine or the drain valve is leaking. <ul style="list-style-type: none"> ■ Turn off the tap. ■ Call Miele.

Insufficient wash results

Problem	Possible cause and remedy
Liquid detergent does not give the required result.	Liquid detergents usually contain no bleaching agents. They do not remove fruit, coffee and tea stains. <ul style="list-style-type: none"> ■ Use a general purpose powder detergent containing a bleaching agent. ■ Pour stain remover powder into compartment III of the dispensing drawer and liquid detergent into a dispenser ball. ■ Never put stain remover powder and liquid detergent together in the dispenser drawer.
White residues which look like powder detergent are seen on dark textiles after washing.	The detergent contains compounds (zeolites) to aid water softening which are not soluble in water. These have ended up on the laundry. <ul style="list-style-type: none"> ■ Try to brush off the residues with a soft brush once the laundry is dry. ■ Wash dark textiles using a detergent which contains no zeolites. Liquid detergents do not usually contain zeolites.
Textiles that were very greasy are not properly clean.	<ul style="list-style-type: none"> ■ Select a programme with pre-wash. Use liquid detergent for the pre-wash. ■ Continue to use universal powder detergent for the main wash.
	The use of heavy-duty detergent is recommended in the main wash for very heavily soiled work clothing. Please seek advice from the detergent manufacturer.
Grey, greasy particles cling to washed laundry.	Insufficient amounts of detergent were used. The laundry was heavily soiled with grease (oils, ointments). <ul style="list-style-type: none"> ■ Use more detergent or liquid detergent with this type of soiled laundry. ■ Before washing the next load, run a 60 °C programme with liquid detergent but without a load.

General problems with the washing machine

Problem	Possible cause and remedy
The washing machine vibrates during the spin cycle.	The machine is not standing evenly. <ul style="list-style-type: none"> ■ The washing machine must be secured to the floor on site according to the instructions on the installation plan.
The pump makes strange noises.	Not a fault Slurping noises occur at the start and end of the pump sequence as a normal part of operation.

Problem	Possible cause and remedy
Large amounts of detergent residues remain in the dispenser drawer.	The water flow pressure is too low. ■ Clean the water inlet filters.
	Powder detergent used in conjunction with water softeners tends to become sticky. ■ Clean the detergent dispenser drawer and, in the future, add washing powder to the dispenser drawer first, and then add the water softener.
Fabric softener is not completely dispensed or too much water remains in the  compartment.	The siphon tube is not correctly positioned or is clogged. ■ Clean the siphon (see “Cleaning and care – Cleaning the detergent drawers, detergent compartments and siphons”).
The display is in a different language.	A different language has been selected. ■ Switch the washing machine off and then on again. The selected supervisor language appears in the display.
	The supervisor language has been changed. ■ Select the language you require (see “Supervisor level – Language”).
The washing machine did not spin the laundry as usual. The laundry is still wet.	The machine detected an imbalance during the final spin and reduced the spin speed automatically. ■ Include both large and small items in the load as this will give better distribution.
The drum remains stationary but the programme keeps running.	Fault in the programme sequence. ■ Switch the washing machine off and then back on with the  button. ■ Note the message in the display. ■ Touch the <i>Start/Stop</i> sensor. The programme will continue and the drum will spin.

The door will not open or close

Problem	Possible cause and remedy
Door opening not possible.	The door is locked during the wash process. ■ Touch the <i>Start/Stop</i> sensor control. ■ Select Programme cancellation or Add laundry. The door will unlock and you will be able to pull it open.
	There is still water in the drum and the washing machine is unable to drain. ■ Empty the drainage system as described in “Problem solving guide”.
Cooling down appears in the display at the end of the programme or after a programme has been cancelled.	To protect the user against scalding, the door cannot be opened if the suds temperature is higher than 50 °C. ■ Wait until the temperature in the drum has decreased and the message has gone out in the display.

Problem solving guide

Problem	Possible cause and remedy
The following appears in the display: F - Door lock fault. Call Miele.	The door lock has jammed. ■ Call Miele.

Opening the door in the event of a blocked drain outlet and/or power cut

⚠ Disconnect the machine from the electrical power supply.

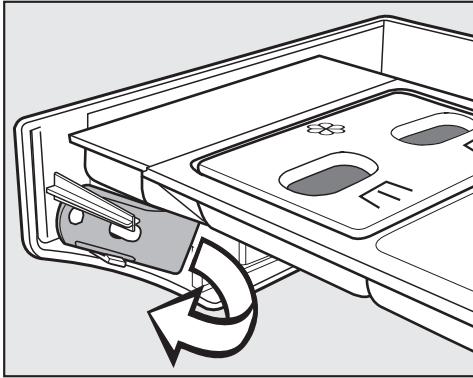

- There is a lever behind the detergent drawer panel which opens the access panel to the drainage system.
For variants with a locked detergent dispenser, the opener is included in the accessory pack.
Remove the lever.

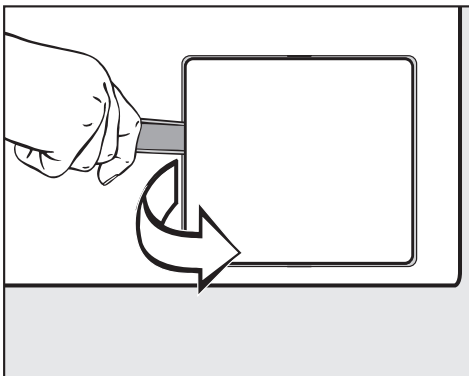

- Open the access panel to the drainage system.

If the drain outlet is clogged, a large amount of water may be retained in the washing machine.

⚠ If laundry has been washed at a high temperature, water draining out of the machine will still be hot.

- Place a suitable container under the access panel.

Do not unscrew the drain filter completely.

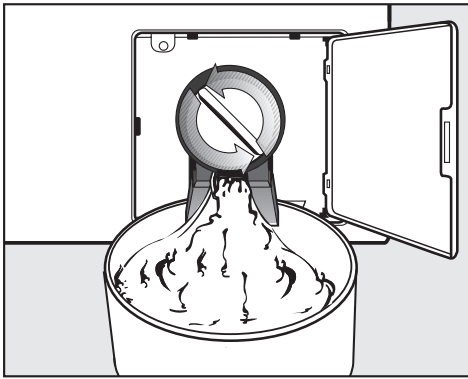

- Unscrew the drain filter to let the water out.
- Tighten the drain filter back up again if you need to interrupt the flow of water.

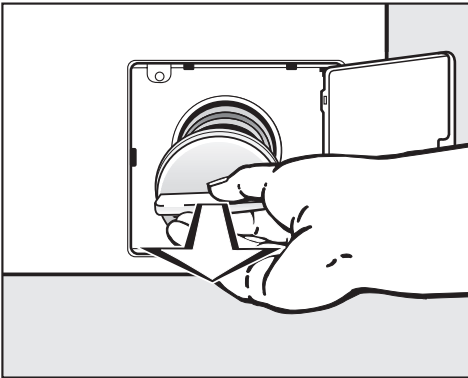

- If no water runs out, unscrew the drain filter completely.
- Clean the drain filter thoroughly.

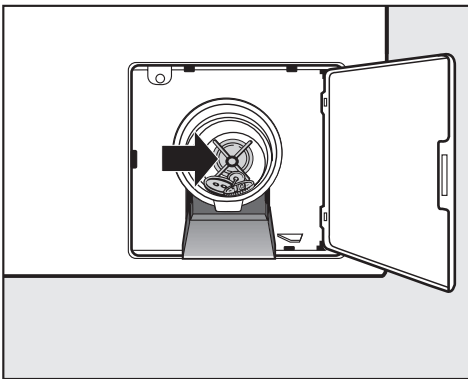

- Remove any foreign objects (e.g. buttons, coins, etc.) and clean the interior. Turn the impeller by hand to check that it rotates freely.
- Put the drain filter back in place and screw it tight.

⚠ Make sure the drain filter is reinserted and securely tightened. Otherwise there is a risk of water leakage during use.

Problem solving guide

Machines with drain valve

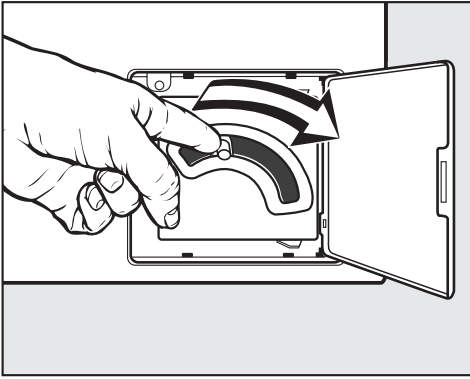

- If the machine has a drain valve, push the emergency drain lever downwards and hold until no more water runs out.

- Carry out cleaning and maintenance of the machine after use if possible.

Do not use a pressure washer or hose to clean the machine.

- Clean the **machine casing, control panel and plastic parts** with a mild, non-abrasive detergent or with a soft damp cloth only. Wipe dry with a soft cloth.

Scouring agents will scratch the surface.

- Clean stainless steel casing with a proprietary stainless steel cleaner.
- Remove any deposits from the door seal with a damp cloth.

Do not allow cleaning agents to penetrate the electrical components.

- When disinfecting the surfaces, use a damp cloth only to clean the front and around the door lock. Do not spray any liquids.

Build-up of rust

The drum is manufactured from rust-free stainless steel. Water or foreign objects containing ferrous substances (e.g. paper clips, metal buttons or metal splinters) which are placed in the machine with the laundry can cause a build-up of rust in the drum. Clean the drum regularly in this case and if rust occurs, remove it immediately with a proprietary stainless steel conditioner. Check the door seals for ferrous residues and clean thoroughly as described above. This must be carried out regularly.

Cleaning the detergent drawers, detergent compartments and siphons

- Clean the detergent drawer and the detergent compartments thoroughly with hot water as required to remove detergent residues and incrustations.
- If the machine is not going to be used for a longer time, leave the flap of the detergent drawer open.

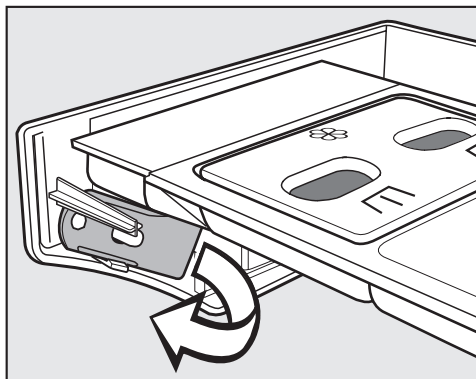

- There is a yellow lever behind the detergent dispenser drawer panel.
- Remove the lever.

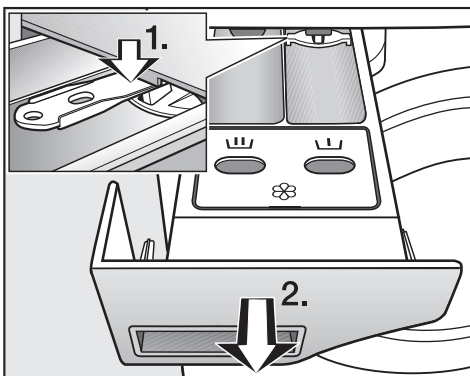

- Pull out the detergent dispenser drawer until a resistance is felt.
 1. Use the lever to push down and release the lock.
 2. Remove the detergent dispenser drawer.

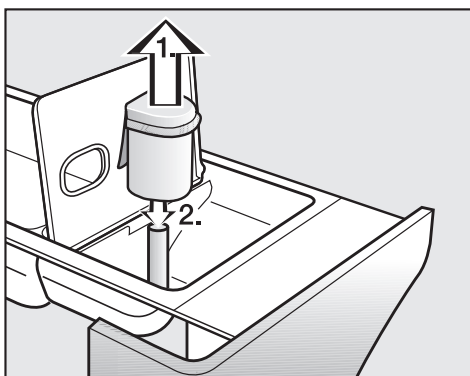

- Clean the siphon.
 1. Remove the siphon from the  compartment and rinse under warm running water. Clean the siphon tube in the same way.
 2. Refit the siphon.

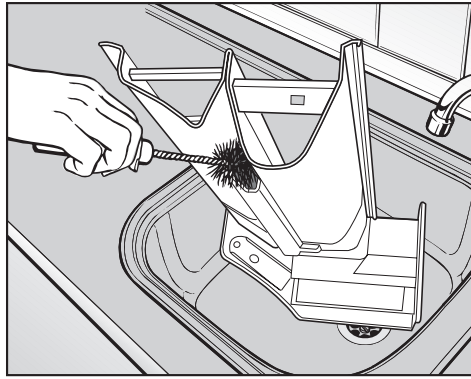

- Clean the fabric softener channel using a brush and warm water.

Clean the siphon and fabric softener channel particularly thoroughly after using liquid starch a few times. Liquid starch results in clogging.

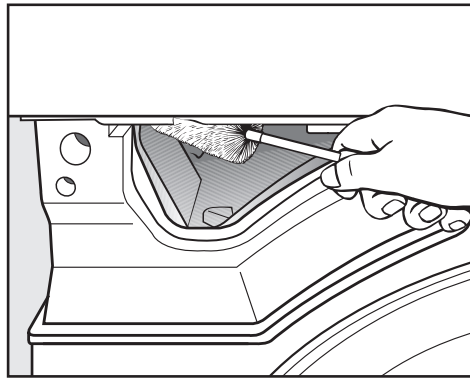

- Use a bottle brush to remove detergent residues and limescale from the jets inside the detergent dispenser drawer.

Cleaning the water inlet filters

The washing machine has filters to protect the water intake valves. You should inspect the filters approximately every 6 months. Perform this check more often if there are frequent interruptions to the external water supply.

Cleaning the filters in the inlet hoses

- Turn off the tap.
- Unscrew the water inlet hose from the tap.

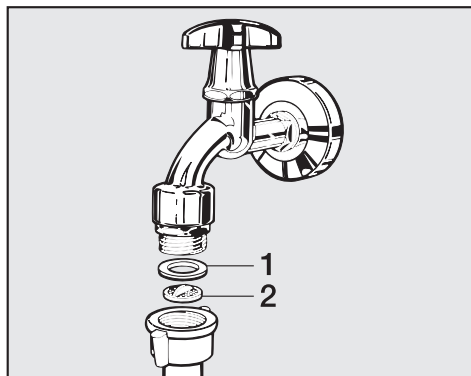

- Remove the rubber seal (1) from the recess.
- Using pointed pliers, take hold of the plastic filter bar (2) and remove it.

Cleaning and care

- Clean the plastic filter.
- Reassemble in reverse order.

Turn on the tap and check the connection is watertight. If water drips out, tighten the connection.

Cleaning the filters in the water intake valves

- Using pliers, carefully loosen the ribbed plastic nut on the intake valve and unscrew.

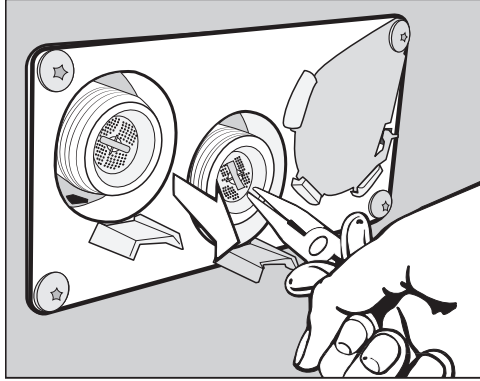

- Use pointed pliers to withdraw the filter by the bar and clean it. Reassemble in reverse order.

The filters must be refitted after cleaning.

Installing the washing machine

The washing machine must be installed by a Miele authorised installer. Please observe the instructions in the installation plan.

This washing machine is only intended for items of laundry that have not been proofed with dangerous or inflammable substances.

- To avoid the risk of frost damage, the washing machine must not be located in rooms which may be subject to very low temperatures.
- Transport the machine on a pallet truck inside the room.

Machines with machine feet must not be slid along the floor. This could damage the machine feet.

- Remove the packaging carefully with a suitable tool.
- Lift the machine off the truck using a lifting device.

Securing the machine

- The feet of the washing machine must be secured to the concrete plinth using the fixtures and fastenings supplied.

The fastening material provided is intended for use in bolting the machine to a concrete floor. For other types of flooring, please purchase suitable fitting materials separately.

General operating conditions

This washing machine is intended only for use in a commercial environment and must only be operated indoors.

Ambient temperature in installation room: 0 °C to 40 °C.

Relative humidity: non-condensing

Depending on the nature of the installation site, sound emissions and vibration may occur.

Useful tip: Have the installation site inspected and seek the advice of a professional in instances where increased noise may cause a nuisance.

For easy maintenance

For ease of future maintenance and servicing, the minimum dimensions and distance to the wall must be observed to enable access.

- The minimum dimensions and distance to the wall must be observed.

Minimum distance to the wall approx. 400 mm to allow for maintenance.

Minimum safety distance to the side 50 mm (wall or other machines).

- Adjust the washing machine screw feet until the machine is level.

The machine must be completely level to ensure smooth operation.

PWM 511

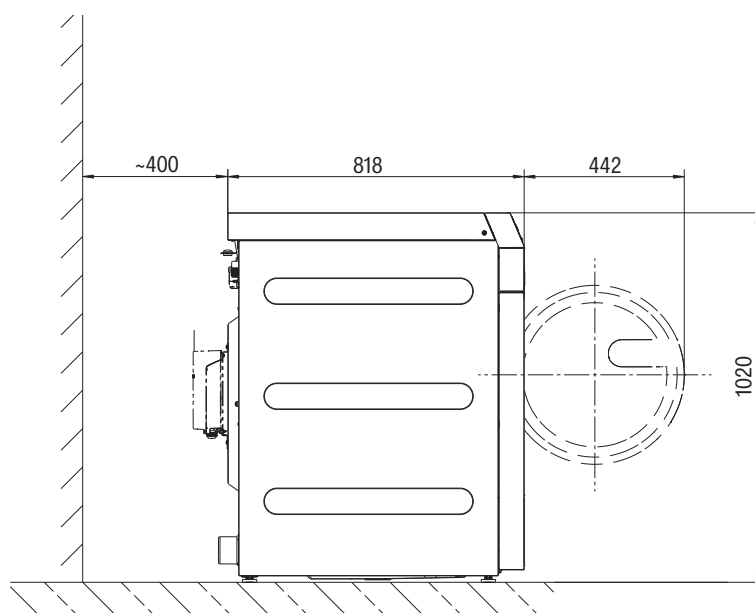

Installing the washing machine

- Transport the washing machine to the installation site.

⚠ Ensure that the washing machine is stable during transportation.

⚠ Do not touch the drum door when lifting.

⚠ The washing machine must not be built under.

Installation on a raised plinth

The machine may be installed on a steel plinth with an open or closed base or on a concrete plinth.



There is the danger of the machine moving and falling off the plinth during spinning.

If the machine is installed on a plinth already present on site, it must be secured using tensioning strips.

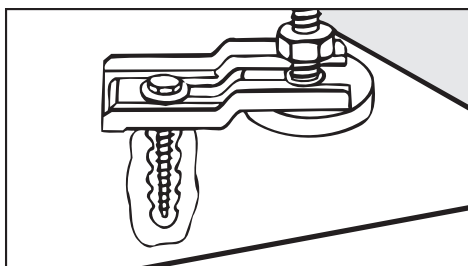

- Secure the front feet of the washing machine with the tensioning strips supplied.
- Follow the installation instructions supplied.

Transit bars

Removing the transit bars

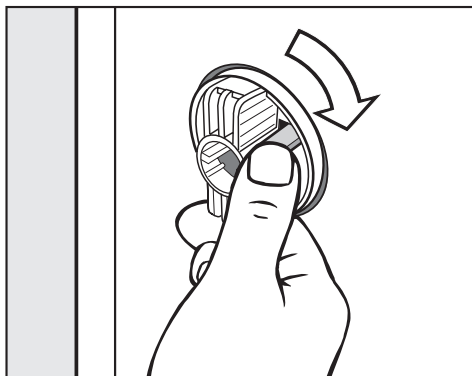

- Release the catch and turn the left-hand transit bar 90° clockwise.

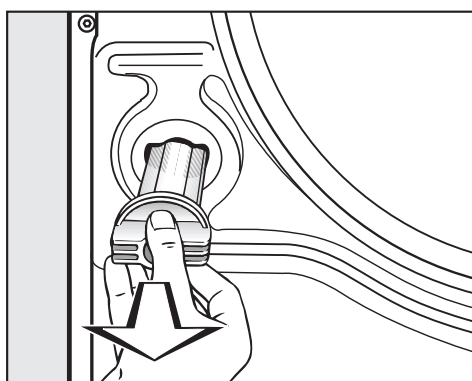

- Then pull the transit bar out.

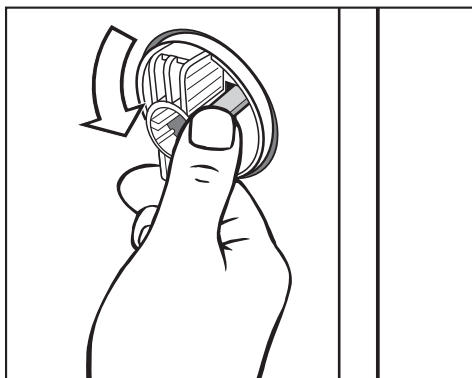

- Release the catch and turn the right-hand transit bar 90° anti-clockwise.

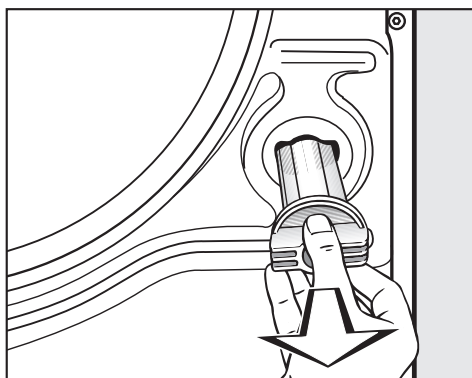

- Then pull the transit bar out.

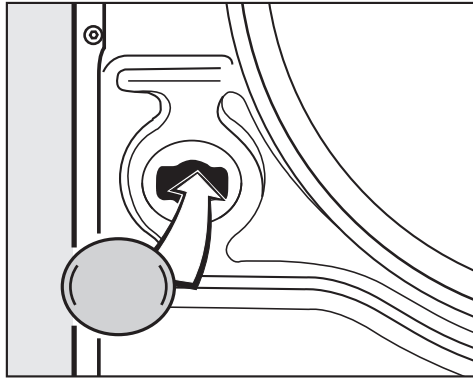

- Fit the supplied stoppers onto the two holes.

Retain the transit bars. They need to be refitted should the machine ever need to be moved again.

Refitting the transit bars

- Refitting is carried out by reversing the procedure.

Levelling the machine

Ensure that the machine feet and the installation surface are dry to prevent the machine from slipping during the spin cycle.

Incorrect installation may increase electricity and water consumption and may cause the machine to move about.

The four adjustable feet are used to level the washing machine. All four feet are screwed in when the appliance is delivered.

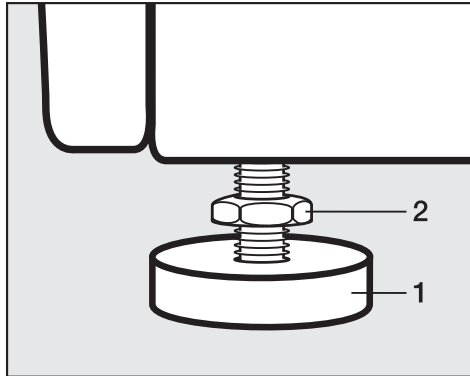

- Using the open spanner supplied, turn the counter nut (2) in a clockwise direction. Then turn the counter nut (2) together with the foot (1) to unscrew.

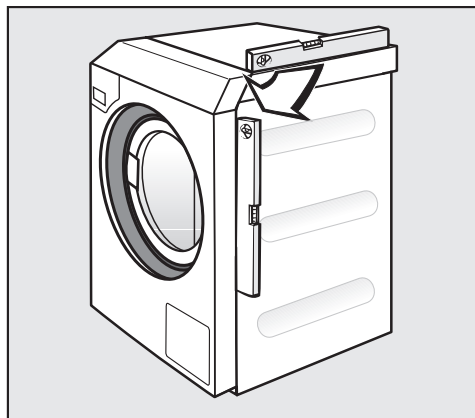

- Use a spirit level to check the machine is standing level.
- Hold the foot (1) securely with a pipe wrench. Turn the counter nut (2) again using the open spanner supplied until it sits firmly up against the casing.

The counter nuts must sit firmly up against the casing. Please also check this for the feet which did not need adjustment. Otherwise there is the danger of the washing machine moving about.

Plumbing

This appliance must be connected to the water supply in strict accordance with local and national requirements (e.g. Plumbing Code of Australia (PCA)). This appliance must be installed according to AS/NZS 3500.1 and AS/NZS 3500.2.

The flow pressure must amount to a minimum of 100 kPa and must not exceed 1000 kPa. If the flow pressure is higher than 1000 kPa, a pressure reducing valve must be used. The machine must be connected to the water supply using the inlet hoses provided.

Use of backflow prevention devices

This appliance must be connected to the water supply in accordance with local and national requirements (e.g. Plumbing code of Australia (PCA)). This appliance must be installed according to AS/NZS 3500.1 and AS/NZS 3500.2. This washing machine has been supplied with a separate backflow prevention device (dual check valve). The dual check valve supplied separately with this product must be installed between the tap and the water inlet hose.

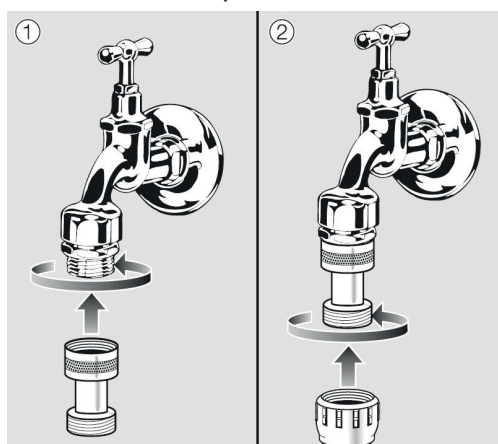

- Screw the dual check valve onto the tap.
- Screw the water inlet hose onto the thread of the dual check valve.

⚠ Health risk and risk of damage due to contaminated incoming water.

The quality of the water used must correspond to the drinking water specification of the country in which the washing machine is being operated.

Always connect the washing machine to drinking water.

Installation

Hot water connection

The same connection requirements as for cold water also apply to hot water up to 70 °C.

A suitable connection hose with a threaded union is supplied with the machine.

The machine with hot water connection also requires a cold water connection.

Cold water connection

For the cold water connection, one tap each with a $\frac{3}{4}$ " screw thread is required.

If a water connection is not available, only a qualified installer may connect the washing machine to the mains water supply.

The inlet hose for cold water is not suitable for connection to a hot water supply.

In the event that hot water is not available on site, a cold water supply must be used for the hot water connection.

The required amount of hot water should be added to the cold water volume.

Alternatively, the hot water connection should be blocked using the blind stopper supplied with the machine and the machine controls should be set to cold water intake by the service technician.

Drain valve (depending on model)

In the case of washing machines with a drain valve, a motorised valve is used to drain the machine. An HT DN 70 angle connector can be used for draining the machine directly into the waste water system (without a siphon) or into an on-site gully (with odour trap).

Thanks to an improved closing mechanism and a larger cross-section, even the coarsest of soiling does not leave any deposits or debris behind which could result in blockages. The drain valve can also be operated manually to allow the suds container to be emptied in the event of a power cut.

A vented drainage system is vital for unimpeded drainage. If several machines are connected to a single drain pipe, this should be sufficiently large to allow all machines to drain simultaneously. The appropriate Miele installation set mat. no.: 05 238 090 is available from Miele for venting an HT DN 70 pipe (not available from Miele).
If the slope for drainage is extremely steep, the piping must be vented to prevent formation of a vacuum in the machine's drainage system.

Slow or obstructed drainage or a backup of water in the drum as a result of undersized pipework can result in faults occurring during programmes, which will result in fault messages appearing in the display.

 Outflowing suds can be as hot as 95 °C. Danger of burning!
Avoid direct contact.

Drain pump (depending on model)

In machines with drain pump, the suds are drained through a drain pump with a delivery head of max. 1 m.

The drain hose must be installed free of kinks for the suds to drain freely.

There are the following options for draining the machine:

- drain hose connected to a plastic drain pipe with a rubber sleeve (there is no need to use a siphon)
- Connected over the rim of the laundry trough or into the sud-saver pipe of the laundry trough
- connected securely to a floor drain (gully)

If required, the hose can be extended to a length of up to 5 m. The corresponding accessories are available from Miele.

For a drain height of more than 1 m, a replacement drain pump for a delivery head of max. 1.8 m is available from Miele.

Electrical connection

The electrical connection must only be carried out by a suitably qualified electrician in accordance with local and national regulations.

A **residual current device (RCD) type B** (sensitive to universal current) must be used if one is being installed.

The electrical components of the machine comply with EN 60335-1, EN 50571.

See data plate for voltage data.

If the machine is hard wired, an all-pole isolator must be installed. Switches with a minimum contact gap greater than 3 mm are suitable isolators. These include circuit breakers, fuses, and contactors.

The plug connector or isolator switch should be easily accessible at all times.

If the appliance is disconnected from the electricity supply, the isolator must be lockable or the point of disconnection must be monitored at all times.

Preventing hazards

If the mains connection cable for this machine is damaged, it must be replaced by the manufacturer, Miele Professional Service or a similarly qualified person.

Observe the enclosed wiring diagram.

Reference to external appliances

A reference to external hardware appears.

- Confirm with the *OK* symbol.

If using a Connector Box, connect it before initial commissioning. The washing machine must be disconnected from the mains for this purpose. Then start the commissioning process.

Optional accessories

Only use genuine Miele spare parts and accessories with this machine.

Using spare parts or accessories from other manufacturers will invalidate the warranty, and Miele cannot accept liability.

Connector Box

The Connector Box allows external hardware from Miele and other suppliers to be connected to the Miele Professional washing machine. The Connector Box is supplied with mains voltage by the Miele Professional machine.

The separately available set consists of the Connector Box and fasteners for installation on the machine or on the wall.

Peak load/Energy management

A peak load or energy management system can be connected via the Connector Box.

The energy management system monitors the energy consumption of a system and deactivates individual pieces of equipment temporarily by means of the peak load cut-out in order to ensure that certain total load limits are not exceeded.

When the peak load function is activated, the heating is deactivated and the programme stopped. A message appears in the display to inform you of this.

The programme is resumed automatically when the peak load function finishes.

Liquid dispensing connection

External liquid dispensing pumps can be controlled by the Connector Box to dispense liquid detergents. An input for empty sensing is assigned to each dispensing pump output. These inputs can be used if required. In addition, flow meters can be connected to each dispensing outlet to monitor the dispensing quantity.

It is particularly important to observe the manufacturer's instructions when using a combination of cleaning agents and special application products.

Payment system

The washing machine can be equipped with a single-machine payment system as an optional accessory via the Connector Box.

The programming required for connecting a payment system can be carried out during the initial commissioning process. After initial commissioning, changes may only be carried out by Miele Professional Service.

Please note that the status of the Connector Box must be set to “on” in the Supervisor level as required. The payment system settings can be configured at the supervisor level.

The payment system is not activated via the supervisor level.

Installation

Wi-Fi/LAN interface

The washing machine is fitted with a Wi-Fi/LAN interface for the purpose of data exchange.

The data interface provided at the LAN connection complies with SELV (Safety Extra Low Voltage). The LAN connection uses an RJ45 connector in accordance with EIA/TIA 568-B.

Connected appliances must also comply with SELV.

Plinth (APWM037/038/039)

The machine can be installed on a plinth (open or box plinth, available as an optional Miele accessory).

Elevating the washing machine gives a better ergonomic working position when loading or unloading. It also simplifies the installation of a waste water connection.

 The washing machine must be secured to the plinth immediately after installation. The plinth must be secured to the floor. There is a risk of the washing machine falling off a raised plinth during a spin cycle if it is not secured.

Opening the Supervisor level

- Switch on the washing machine.

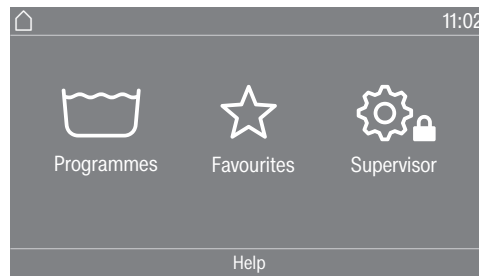

- Touch the Supervisor  selection area.

The display will change to show the Supervisor level menu.

Opening the supervisor level (self-service)

- Switch on the washing machine and open the door.
- ① Touch the *Start/Stop* sensor and hold it down whilst carrying out steps ②–③.
- ② Close the washing machine door.
- ③ Wait until the *Start/Stop* sensor, which is now flashing rapidly, lights up constantly.
- ④ Release the *Start/Stop* sensor when the *Start/Stop* sensor lights up constantly.

Code-based access

The Supervisor level is accessed using a code.

The code is **8000** (factory default setting).

After entering the code, you will be in the Supervisor level. The individual setting options are described in the following sections.

Changing the code

You can change the Supervisor level access code to protect the washing machine from unauthorised access.

Please inform Miele Professional Service if you have forgotten your new code. Miele Professional Service will have to reset the code. Make a note of your new code and store it in a safe place.

Closing the Settings menu

- Touch the  symbol.

The display will then go back to the previous menu level.

- Touch the  symbol.

The display will change to the main menu.

Supervisor level

Controls / Display

Language

The display contents can be displayed in a variety of languages. You can select the permanent supervisor language via the Language sub-menu.

When a programme is running, you can change the user language using the  sensor.

Language entry

The display can be set to one of several different user languages. This setting allows you to determine how languages can be selected.

International

6 languages are available. The  sensor is not active. Note the setting *Set languages*.

Language selection

The  sensor can be used to select a language. All languages are available (factory default setting).

You can change the order of the first 4 languages. These slots are allocated to the most commonly used languages.

Default language

The user language cannot be changed. The user language is the same as the supervisor language. The  sensor is not active.

Set languages

The languages for the setting *Language entry International* can be changed.

6 languages can be selected. All languages are available.

If you wish to add a new language to the language menu:

- First select the language you want to replace.

All available languages are displayed.

- Select and confirm the language that is to replace the previous language.

The new language will appear in place of the old one.

Time	<p>After selecting the clock format, you can set the time of day.</p> <p><u>Clock format</u></p> <ul style="list-style-type: none">- 24 h clock- 12 h clock- No clock <p><u>Set</u></p> <ul style="list-style-type: none">- The time can be set.
Date	<p>The date can be set after selecting the date format.</p> <p><u>Date format</u></p> <ul style="list-style-type: none">- DD.MM.YYYY- YYYY.MM.DD- MM.DD.YYYY <p><u>Date</u></p> <ul style="list-style-type: none">- The date can be set.
Logo	Different logos can be selected for the user interface.
Start screen	Different views can be selected for the start screen. The start screen is displayed after exiting a sub-menu.
Mode	Different supervisor modes can be selected.
Display brightness	<p>The brightness of the display can be altered. The setting depends on the various lighting conditions in the place of installation.</p> <p>It can be set to one of 10 different levels.</p>
“Display off” status	<p>In order to save energy, the display can be set to switch to standby mode automatically after the end of the programme or if no further selection is made. In the default setting, the machine will not switch to standby mode automatically.</p> <p>Changing this factory default setting may lead to increased energy consumption.</p> <ul style="list-style-type: none">- Off- On (10 min.) Not curr.prog.- Logo (10 min.) Not curr.prog.- On after 10 min.- On (30 min.) Not curr.prog.- Logo (30 min.) Not curr.prog.- On after 30 min.
“Machine off” status	<p>In order to save energy, the washing machine can be set to switch to standby mode automatically after the end of the programme or if no further selection is made. In the default setting, the machine will not switch to standby mode automatically.</p> <p>Changing this setting may lead to increased energy consumption.</p> <ul style="list-style-type: none">- No switch-off (factory default setting)

Supervisor level

- Switch-off after 15 minutes
- Switch-off after 20 minutes
- Switch-off after 30 minutes

Volume

The volume for various sounds can be changed.

It can be set to one of 7 different levels or switched off altogether.

- Finish tone
- Keypad tone
- Welcome tone
- Fault tone

The fault tone can be activated or deactivated.

Visibility parameters

Various parameters, such as the temperature, spin speed, Extras etc., are displayed when a programme is selected. You can decide which parameters should not be displayed. The parameters cannot be changed/are no longer displayed.

Factory default: all parameters are visible (marked in orange)

Sorting Extras

In the setting Visibility parameters, Sort Extras appears in the bottom line. Touch the sensor to change the sequence of Extras (see "Supervisor level – Moving programmes").

Delay start

The Delay start (Timer) display can be switched on or off.

Factory default setting: On

Memory

The washing machine will save the latest settings (temperature, spin speed and some of the options) which have been selected for a programme after the programme has started.

When the programme is selected again, the saved settings will appear in the display.

Factory setting: Off

Measuring system

You can choose whether the temperature and weight are displayed in metric or imperial units.

Supervisor code

You can alter the access code to the supervisor level. The supervisor code is independent of the expert code.

- Enter the current code.
- Then enter your new code.

When creating a new code, number sequences such as 1234 and 4-digit numbers such as 2222 are not permitted.

Wi-Fi

In this menu, you control the networking of your washing machine (see "Networking").

Programme selection

Controls

Useful tip: Start by configuring all necessary settings and changes to the washing machine before adjusting any of the options below.

If “Launderette, basic” or “Launderette Logo” is selected, the Supervisor level can no longer be opened from the display after the *Supervisor level* is closed. Please follow the instructions below for special access to the Supervisor level if you wish to change any other settings.

Standard (factory default setting).

All functions and programmes can be displayed.

Launderette, basic

Up to 24 programmes are available. Go to Favourite programmes to select which programmes are to be listed.

Launderette logo

Up to 24 programmes are available. Go to Favourite programmes to select which programmes are to be listed.

External programme selection

Programmes are selected using a communication module with Ethernet, e.g. via an external terminal.

Programme packages

The selection of programmes can be expanded by activating single programmes from the target group programme packages.

The programmes selected from the programme packages (marked in orange) are displayed during programme selection.

Favourite programmes

After switching on, you can also select a programme via:

☆ Favourites.

24 programmes can be stored as favourite programmes based on your own priorities and requirements.

These favourite programmes will also be made available in the control options

- *Launderette logo*

- *Launderette, basic* control options.

You can specify the control options under Controls.

Useful tip: You can assign a separate coloured frame to each programme. In this case, the “Colour assign. programme” setting must be set to *On*.

Changing Favourite programmes

■ Select the programme you wish to change or replace.

■ Confirm the programme or the setting to be changed.

Another menu opens, enabling you to select a new programme or change the parameters.

■ Confirm by touching the *Save* selection area.

Your selection is now active.

Supervisor level

Moving programmes

Programmes can be moved within the programme list and in the Favourites list.

Factory setting: Off

- Touch the selection area for the programme you want to move.
- Press and hold the selection area until the frame changes.
- Drag the programme to the required position.

Prog. colour allocation

You can assign a frame to a Favourite programme. In the list of favourites, each Favourite programme is given a coloured frame, which can be adjusted.

Factory default setting: on

Expert code

A code needs to be entered to cancel a disinfection programme. The code can be changed.

The expert code is independent of the supervisor level code.

The code is: 8 0 0 0

Make a note of your new code if you ever change it.

Process technology

Anti-crease

The Anti-crease function helps prevent creasing if laundry is not going to be removed immediately after the end of the programme. The drum continues to turn at intervals for up to 30 minutes at the end of the programme.

The door can be opened at any time during the Anti-crease phase.
Factory default setting: On

Supervisor level

Automatic drainage

Automatic water drainage can be switched on or off. Automatic water drainage means that the suds are always drained away after the end of a programme. This is also the case for programmes that reach the programme end with water still in the drum.

Factory default setting: off

Service

Service interval

Service information can appear in the display. You can configure whether a date or the number of operating hours is displayed.

You can select up to 2 messages with your own text.

Your message is displayed at the end of the programme and can be acknowledged with *OK*. The same message appears at the end of the next programme.

Settings

This setting allows you to determine the interval (by hours or date) at which the message appears.

- Factory default setting: off
- By time
You can then select a time interval between 1–9999 hours.
- By date
You can then select a date.

Message text

Enter your individual message text for your planned maintenance work.

Reset display

The message will appear until the display is permanently reset. The message then only appears again when the next interval is reached.

External applications

Payment system lock

The payment device lock can be switched on or off. When the lock is switched on, the duration until locking can be selected from various time intervals.

Connector box

External hardware is connected via the Connector Box. This can be switched on or off.

The Connector Box must be selected in order for settings to be made in the Dispensing menu.

Automatic dispensing

Automatic dispensing can be switched on or off.

Automatic dispensing can be activated via the Connector Box or the COM module.

Dispensing

The Connector Box must be switched on in order for settings to be adopted in the Dispensing menu.

1–6 dispenser pumps can be switched on.

Further settings can be made after activating the dispenser pump.

- Deactivate disp. pump

- Calibration
- Flow rate (new): ml/min
- Correction factor
- Container size
- Adv. warning level reminder
- Reset adv. warning
- Level reminder
- Flow meter

Peak load prevention

The peak load prevention function can be switched on or off. With this function, the execution of a wash programme is not affected when a peak load signal is in place. The heater stays switched on.

Machine parameters

Maximum spin speed

The maximum spin speed can be set via a keypad.

Max. possible temperature

The maximum temperature can be set via a keypad.

Legal information

[Open source licences](#)

You can view information here (see "Wi-Fi data protection").
--

Networking

Pairing instructions

Follow the steps below to connect the washing machine to your network.

Network connection

Miele Professional washing machines can be integrated into local networks to utilise Miele's digital solutions or communicate with external systems. The washing machines are equipped with an integrated Wi-Fi module for this purpose. In addition, the washing machines each have an Ethernet connection at the rear for setting up wired interfaces.

⚠ Unauthorised access poses a health risk.

Settings in the washing machine, e.g. parameters for disinfection or the dispensing of process chemicals, may be changed as a result of unauthorised access via the network. Under no circumstances should it be possible to access the washing machine via the Internet or other public or unsecured networks, either directly or indirectly (e.g. using port forwarding).

1. The washing machine should be operated only in a separate network segment which meets one of the following requirements:
 - It is physically separated from other network segments.
 - Access to the segment is restricted by a firewall or a router which has been configured accordingly.
2. Limit access to this separate network segment to persons requiring access in the course of their work.
3. Use strong passwords to protect access to systems that are connected to the washing machine.
4. Configure the Ethernet interface.

Opening the Supervisor level

- Select the Supervisor menu option in the machine display.
- Select the Access via code menu option.
- Enter the 4-digit supervisor code.

Initial network setup

- Select the Supervisor level menu option from the External applications menu.
- Select Wi-Fi / LAN.

The options in the Wi-Fi / LAN menu vary depending on whether the Wi-Fi interface is already set up or needs to be set up.

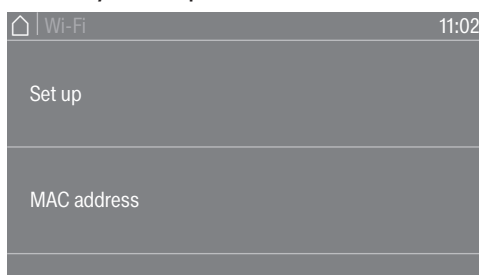

- Select Set up to connect the machine to a network.

The message Set up only appears if the washing machine has not yet been connected to a Wi-Fi network. Various options are available for setting up the Wi-Fi interface.

- Select MAC address to read out the MAC addresses of the network adapters.

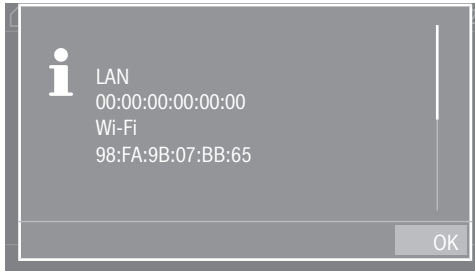

The MAC address of the network adapters is displayed. No settings can be made.

Setting up a network connection manually

- Select the Supervisor level menu option from the External applications menu.
- Then select the Wi-Fi / LAN menu option.
- Select Set up.
- Select the Manual connection method.

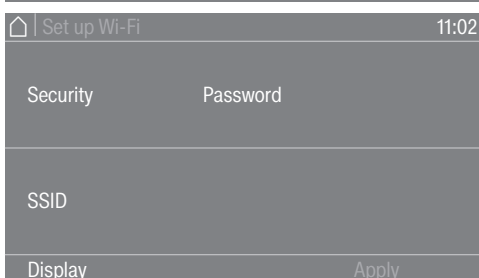
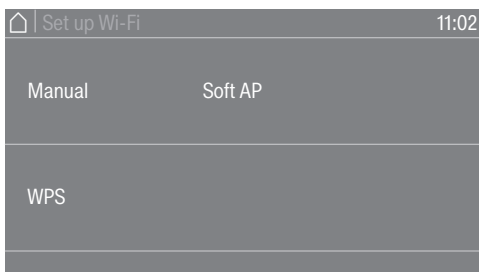

- Select Security to set the security standard for the wireless connection.
- Select Password to enter the Wi-Fi password.
- Select SSID to enter the network name (SSID).

You can view all settings for Security, Password and SSID under Display.

- Save all settings with Apply.

Networking

Establishing the network connection via WPS

- Select the Supervisor level menu option from the External applications menu.
- Then select the Wi-Fi / LAN menu option.
- Select Set up.
- Select the Via WPS connection method.
- Now press the WPS button on your router and confirm with OK in the machine display.

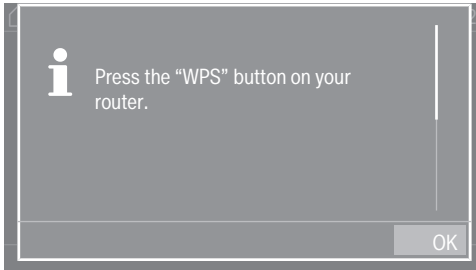

A timer starts. The network connection via WPS is being established.

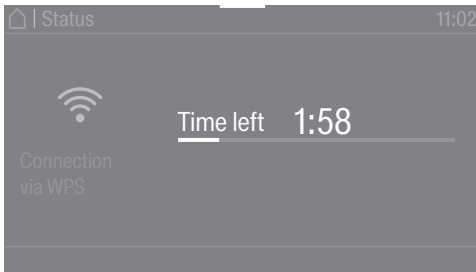

The machine is now successfully connected.

- Touch OK to confirm.

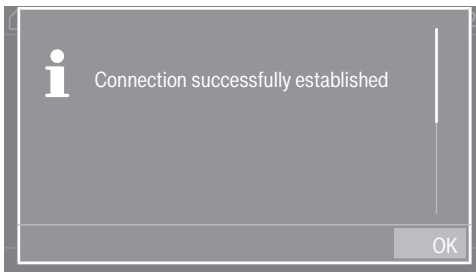

Establishing the network connection via soft AP

- Select the Supervisor level menu option from the External applications menu.
- Then select the Wi-Fi / LAN menu option.
- Select Set up.
- Select the Via Soft AP connection method.
- Confirm by pressing OK and follow the instructions in the external application.

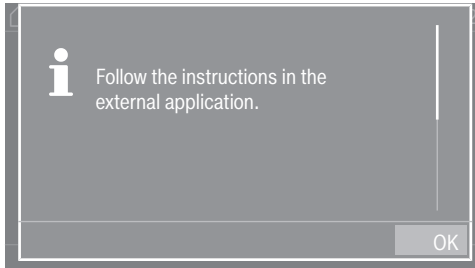

The display shows the message *Waiting for connection* for approx. 10 minutes. If the connection is successful, a message is then displayed. If the connection has failed, the message *Connection failed* is displayed.

- If the connection fails, confirm with OK and start a new connection attempt.

Establishing the network connection using a LAN cable

- Connect the machine to your router/switch using the network cable.

The machine is now successfully connected.

Networking

Wi-Fi/LAN interface configured

Once the network connection has been successfully set up, you can select further options in the menu.

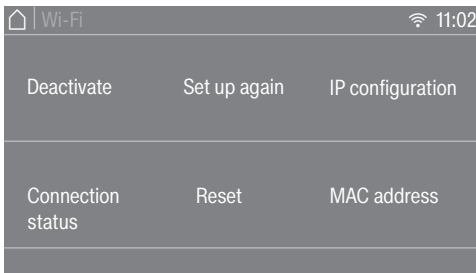

- The Wi-Fi function is switched off with **Deactivate** (visible when the network is activated). The network remains set up.
- The Wi-Fi function is reactivated with **Activate** (visible when the network is deactivated).
- All network parameters are displayed under **Connection status**.
- You can set up the Wi-Fi interface again under **Set up again**.
- Use **Reset** to disconnect the network setup. The Wi-Fi function is deactivated and the Wi-Fi connection will be reset to the factory default settings. A new connection has to be established in order to use the network again.
- You can configure the IP settings manually under **IP configuration**. The interface can be set up via a Dynamic Host Configuration Protocol (DHCP). If you deactivate the DHCP setting, you can configure the interface using the following parameters:
 - IP address
 - Subnet mask
 - Gateway
 - DNS Auto
 - DNS server 1
 - DNS server 2
- The address of the network adapters is displayed under **MAC address**.

Technical data

System requirements for Wi-Fi

- Wi-Fi 802.11b/g/n
- 2.4 GHz band
- WPA/WPA2 encryption
- DHCP activated
- Multicast DNS / Bonjour / IGMP snooping activated
- Ports 443, 80, 53, and 5353 open
- IP DNS server = IP standard gateway/router
- Mesh/Repeater use: same SSID and password as standard gateway/router
- SSID must be permanently visible



System requirements for LAN

- DHCP activated
- Multicast DNS / Bonjour / IGMP snooping activated
- Ports 443, 80, 53, and 5353 open
- IP DNS server = IP standard gateway/router

Wi-Fi signal strength – Guide values

The Wi-Fi signal strength is only a rough guide. These details do not provide absolute certainty.

The Wi-Fi signal strength can be read directly on the machine.

Wi-Fi signal strength		Meaning
	 *	
76–100%	3/3**	Generally, reliable operation possible
51–75%	2/3	
26–50%	1/3	Generally, operation possible
1–25%	0/3	Generally, reliable operation not possible
0 %		Operation not possible

* Displayed on the machine

** Number of bars  3/3–0/3

The signal strength can be adversely affected by many factors:

- People in the room
- Open or closed doors
- Moved objects
- Varying radio signal sources or interference
- Other machines with Bluetooth or Wi-Fi wireless technology

Technical data

PWM 511 machine data

Electrical connection

Supply voltage	see data plate
Frequency	see data plate
Total rated load	see data plate
Current draw	see data plate
Fuse rating	see data plate
Heater rating	see data plate

PWM 511 installation dimensions

Casing width (without add-on components)	692 mm mm
Casing height (without add-on components)	1012 mm mm
Casing depth (without add-on components)	818 mm mm
Overall machine width	700 mm mm
Overall machine height	1020 mm mm
Overall machine depth	845 mm mm
Minimum width of transport opening	800 mm mm
Minimum distance between wall and rear of appliance	400 mm mm
Diameter of door opening	370 mm mm
Door opening angle	180°

Weight and floor load

Net weight	see installation plan
Maximum floor load during operation	see installation plan

Emissions data

Sound pressure level emission in workplace in accordance with EN ISO 11204/11203	<70 dB(A) re 20 µPa
Sound power level EN ISO 9614-2	<80 dB (A)

Wi-Fi

Frequency band of the Wi-Fi module	2.400–2.4835 GHz
Maximum transmission power of the Wi-Fi module	< 100 mW

Product safety

Product safety standard

EN 60335-1, EN 50571, AS/NZS 60335-1, AS/NZS 60335-2-7

Data protection and data security

When you activate the networking function and connect your machine to the Internet, your machine sends the following data to the Miele Cloud:

- Machine serial number
- Machine model and technical features
- Machine status
- Information about the software status of your machine

Initially, this data cannot be assigned to a specific user and is not saved permanently. Data cannot be saved permanently or assigned to a specific user until after you have linked your machine to a user. Data transmission and processing are governed by Miele's strict security standards.

Factory default settings for network configuration

You can reset all of the settings on the communication module or your integrated Wi-Fi module to the factory default settings. The network configuration should be reset whenever a machine is being disposed of or sold, or if a used machine is being put into operation. This is the only way to ensure that all personal data has been removed and, in the case of the latter, the previous owner will no longer be able to access the machine.

Copyright and licences

For the purpose of operating and controlling the communication module, Miele uses proprietary or third-party software that is not covered by open source licensing terms. These items of software/software components are protected by copyright. The copyright powers of Miele and third parties must be respected.

Furthermore, this communication module contains software components which are distributed under open source licence conditions. The open source components contained in the machine along with the corresponding copyright notices, copies of the licensing terms valid at the time and any further information can be accessed locally by IP using a web browser (*https://<IP address>/Licenses*). The liability and warranty arrangements for the open source licences displayed in this location only apply in relation to the respective rights holders.

Miele Australia Pty. Ltd.

ACN 005 635 398

ABN 96 005 635 398

Melbourne:

Level 4, 141 Camberwell Road

Hawthorn East, VIC 3123

Telephone: 1300 731 411

professional.service@miele.com.au

www.miele-professional.com.au

professional.sales@miele.com.au

Miele New Zealand Limited

IRD 98 463 631

8 College Hill

Freemans Bay

Auckland 1011

New Zealand

Telephone: 0800 4 MIELE

(0800 464 353)

www.miele-professional.com.au

professional.sales@miele.com.au



Miele Global Headquarters: Miele & Cie. KG
Carl-Miele-Straße 29, 33332 Gütersloh, Germany