



## Operating instructions Commercial washing machine PWM 927 PWM 935













---

It is **essential** to read these operating instructions before installing and using the appliance. This prevents both personal injury and damage to the appliance.

AU, NZ

# Contents

---

<b>Warning and Safety instructions</b> .....	<b>6</b>
Explanation of the safety notes and warnings on the machine .....	6
Correct application.....	6
Preventing problems .....	7
Technical safety .....	7
Correct use.....	9
Chlorine and component damage.....	10
Accessories .....	10
Caring for the environment .....	11
<b>Guide to the machine</b> .....	<b>12</b>
Guide to the machine .....	12
Control panel.....	13
<b>Operation</b> .....	<b>14</b>
Sensors and touch display .....	14
Main menu .....	14
Examples of how to operate the machine .....	14
Operating the launderette version .....	17
<b>Washing</b> .....	<b>18</b>
Preparing for use .....	18
Loading and switching on the washing machine .....	19
Washing with dispenser drawer.....	19
Selecting a programme .....	21
Selecting programme settings .....	22
Selecting Extras.....	27
Pre-wash  .....	27
Soak  .....	27
Rinse plus  .....	27
Rinse hold  .....	27
Filling stop  .....	27
Intensive  .....	27
Water plus  .....	27
Programme start – programme end .....	28
Timer .....	30
<b>Special features in the programme sequence</b> .....	<b>31</b>
Spin.....	31
Anti-crease .....	31
Skip.....	31
Manual control.....	31
Switching to manual control .....	31
Water intake  .....	33
Dispensing  .....	33
Washing and heating  .....	33
Drain with agitation  .....	33
Spin  .....	33
Function combinations .....	33
Weighing system .....	35
Resetting the load display to zero .....	35

<b>Changing the programme sequence</b> .....	<b>36</b>
Changing a programme .....	36
Altering the wash programme.....	36
Interrupting a programme .....	36
Switching on the washing machine after a power failure .....	36
Adding or removing laundry .....	37
<b>Problem solving guide</b> .....	<b>38</b>
Problem solving guide.....	38
Contact in case of fault.....	40
Problem solving guide.....	40
The programme does not start.....	40
Programme cancellation and fault message .....	41
There is a message in the display .....	41
Insufficient wash results .....	42
General problems with the washing machine.....	42
The door will not open or close .....	44
Continuing a programme after an interruption to the power supply .....	44
<b>Cleaning and care</b> .....	<b>45</b>
Build-up of rust.....	45
Cleaning the detergent drawers, detergent compartments and siphons.....	46
<b>Installation</b> .....	<b>48</b>
Installing the washing machine .....	48
Securing the machine .....	48
General operating conditions .....	48
For easy maintenance.....	49
Water connection.....	50
Steam connection (depending on country).....	50
Dispenser pump connections .....	52
Drainage.....	53
Electrical connection .....	53
<b>Supervisor level</b> .....	<b>54</b>
Opening the Supervisor level.....	54
Opening the supervisor level (self-service) .....	54
Code-based access .....	54
Changing the code .....	54
Closing the Settings menu.....	54

# Contents





---

Controls / Display.....	55
Language.....	55
Language entry.....	55
Set languages.....	56
Time.....	56
Date.....	56
Logo.....	56
Start screen.....	56
Mode.....	56
Display brightness.....	56
“Display off” status.....	56
“Machine off” status.....	57
Volume.....	57
Visibility parameters.....	57
Delay start.....	57
Memory.....	57
Manual control.....	57
Change order.....	57
Measuring system.....	57
Supervisor code.....	57
Wi-Fi.....	58
Programme selection.....	58
Controls.....	58
Programme packages.....	58
Favourite programmes.....	58
Moving programmes.....	59
Prog. colour allocation.....	59
Expert code.....	59
Process technology.....	59
Anti-crease.....	59
Automatic drainage.....	59
Service.....	60
Service interval.....	60
External applications.....	60
Payment system lock.....	60
Connector box.....	60
FOC programmes.....	60
WRG.....	60
Automatic dispensing.....	60
Dispensing.....	60
Peak load prevention.....	61
Wi-Fi.....	61
Machine parameters.....	61
Maximum spin speed.....	61
Max. possible temperature.....	61
Legal information.....	61
Payment system.....	61
Settings for the payment system.....	61

<b>Networking</b> .....	<b>62</b>
Pairing instructions .....	62
Network connection.....	62
Opening the Supervisor level.....	62
Initial network setup.....	62
Setting up a network connection manually .....	63
Establishing the network connection via WPS .....	64
Establishing the network connection via soft AP .....	65
Establishing the network connection using a LAN cable.....	65
Wi-Fi/LAN interface configured .....	66
Technical data .....	66
<b>Technical data</b> .....	<b>68</b>
PWM 927 machine data .....	68
Installation dimensions.....	68
Electrical connection.....	68
Weight and floor load.....	68
Emission values.....	68
Product safety .....	68
Wi-Fi .....	68
PWM 935 machine data.....	69
Installation dimensions.....	69
Electrical connection.....	69
Weight and floor load.....	69
Emission values.....	69
Product safety .....	69
Wi-Fi .....	69
<b>Wi-Fi data protection</b> .....	<b>70</b>
Data protection and data security .....	70
Factory default settings for network configuration .....	70
Copyright and licences .....	70

## Warning and Safety instructions

### Explanation of the safety notes and warnings on the machine

	Read the operating instructions
	Warning: hot surfaces
	Warning: voltage up to 1000 volts
	Protective earth
	Equipotential bonding

This washing machine complies with all current local and national safety requirements. However, inappropriate use can lead to personal injury and damage to property.

Read the operating instructions carefully before using the washing machine. They contain important information on safety, installation, use and maintenance. This prevents both personal injury and damage to the washing machine.

Miele expressly and strongly advises that you read and follow the instructions in the chapter on installing the washing machine as well as the warning and safety instructions.

Miele cannot be held liable for injury or damage caused by non-compliance with these instructions.

Keep these operating instructions in a safe place and pass them on to any future owner.

When instructing other people how to use the washing machine, they must be made aware of these warning and safety instructions.

### Correct application

- ▶ The washing machine is only suitable for washing fabrics with a care label stating that they are suitable for machine washing. Any other applications may be dangerous. The manufacturer cannot be held liable for damage resulting from incorrect or improper use or operation of the machine.
- ▶ This washing machine must be used as described in the operating instructions and must be checked on a regular basis to make sure it is functioning correctly. Maintenance must be carried out when necessary.
- ▶ The washing machine is not suitable for outdoor use.
- ▶ Do not install the washing machine in a room where there is a risk of frost. Frozen hoses can tear or burst. The reliability of the electronic control unit may be impaired at temperatures below freezing point.
- ▶ The washing machine is designed for commercial use only.
- ▶ If the machine is used in a commercial environment, it may only be operated by instructed/trained personnel. If the machine is to be operated in an area accessible to the public, the supervisor must ensure that it can be operated safely without risk of danger to others.

## Warning and Safety instructions

---

- ▶ The machine must not be installed and operated in mobile locations (e.g. on a ship).
- ▶ This washing machine is not intended for use by persons (including children) with reduced physical, sensory or mental capabilities, or lack of experience and knowledge, unless they have been given supervision or instruction concerning its use by a person responsible for their safety.
- ▶ Young children must not be allowed to use this appliance.
- ▶ Older children may only use the appliance when its operation has been clearly explained to them and they are able to use it safely. They must be able to understand and recognise the possible dangers of misuse.
- ▶ Cleaning or maintenance on the washing machine may only be carried out by older children under the supervision of an adult.
- ▶ Always supervise any children in the vicinity of the washing machine. Never allow children to play with the washing machine.
- ▶ Disinfection programmes must not be interrupted, as this can have a limiting effect on the disinfection result. It is the operator's responsibility to ensure that the standard of disinfection in thermal as well as chemo-thermal procedures is maintained by carrying out suitable validation tests.

### Preventing problems

- ▶ Never use solvent-based detergents, e.g. those containing benzene, in this washing machine. This may result in damage to component parts and create toxic fumes. **Risk of fire and explosion!**
  - ▶ Do not damage, remove or bypass the safety components or control elements of the washing machine.
  - ▶ If the supply cord is damaged, it must be replaced by the manufacturer, its service agent or similar qualified person in order to avoid a hazard.
  - ▶ The water generated during washing is suds solution and not drinking water. Drain the suds solution into a proper drainage system.
  - ▶ Always make sure that the drum is stationary before reaching in to remove laundry. Reaching into a moving drum is extremely dangerous and may result in injury.
  - ▶ Be careful not to put your hands in the gap between door and frame when closing the drum door.
- Please note:** the drum door is locked automatically as soon as the washing machine starts.
- ▶ It is particularly important to observe the manufacturer's instructions when using a combination of cleaning agents and special application products. Products must only be used for applications approved by the manufacturer to avoid any material damage or the occurrence of strong chemical reactions.

### Technical safety

- ▶ Before installing and operating the washing machine, check it for any visible exterior damage. Do not install or operate a damaged washing machine.

## Warning and Safety instructions

---

▶ The electrical safety of this washing machine can only be guaranteed when continuity is complete between it and an effective earthing system which complies with current local and national safety regulations. It is most important that this basic safety requirement is present and regularly tested and, where there is any doubt, the on-site wiring system should be inspected by a qualified electrician. Miele cannot be held liable for the consequences of an inadequate earthing system (e.g. electric shock).

▶ Unauthorised repairs could result in unforeseen dangers for the user, for which the manufacturer cannot accept liability. Repairs must only be carried out by a Miele authorised service technician, otherwise any subsequent damage will not be covered by the warranty.

▶ Do not make any alterations to the machine, unless authorised to do so by Miele.

▶ Disconnect the washing machine from the power supply in the event of a fault, for maintenance work and for cleaning and care. The washing machine is only isolated from the electricity supply when

- the mains plug of the washing machine is unplugged, or
- the mains fuse is disconnected, or
- it is switched off at the mains circuit breaker.

For further information see "Installation – Electrical connection".

▶ The washing machine may only be connected to the water supply using the new hose set supplied with the machine. Old hoses must not be re-used. Check the hoses regularly for signs of wear. Change the hoses in good time to avoid the risk of leaks and water damage. The water flow pressure must be at least 100 kPa and must not exceed 1000 kPa.

▶ If leakages occur, remedy their cause before operating the washing machine again. Immediately disconnect the washing machine from the electricity supply when leaking occurs.

▶ In case of malfunctions of the steam heater, temperatures in the area of the drum door, the front of the detergent dispensing drawer and the inside of the drum (especially the drum edge) may be elevated. There is a risk of minor burns.

This only applies to appliances with steam heating.

▶ Faulty components must only be replaced by genuine Miele original spare parts. Miele can only guarantee the safety standards of the machine when Miele replacement parts are used.

▶ Please observe the instructions in "Installation".

▶ If the washing machine is connected using a mains plug, the mains plug must always be kept accessible so that the washing machine can be easily disconnected from the power supply.

▶ If the washing machine is hard wired, provision must be made on site to switch off all poles from the electricity supply. The means for disconnection must be incorporated in the fixed wiring in accordance with the wiring rules, AS/NZS 3000. The disconnection switch must be located in the immediate area around the washing machine, and must always be visible, accessible and easily reachable.

▶ Machines with damaged control elements or cable insulation may only be replaced by the manufacturer/Miele Professional Service or a qualified electrician.

▶ A damaged power supply cord must be replaced by a technician authorised by Miele.

### Correct use

- ▶ The maximum load size for PWM 927 is 27 kg and for PWM 935 is 35 kg. See the “Programme overview” for the maximum recommended load sizes for individual programmes.
- ▶ Before using the washing machine for the first time, ensure that the transport safety devices have been removed (see “Installation – Removing the transport safety devices”). If the transport safety devices are not removed, they may cause damage to adjacent furniture or machines during the spin cycle.
- ▶ Never try to open the drum door of the washing machine using force. The drum door can only be opened if appropriate information is shown in the display.
- ▶ Do not push the suspended drum unit while the machine is running.
- ▶ When closing the drum door there is a risk of injury between the door frame and drum opening, as well as at the hinges.  
Caution: the drum door is locked automatically when the machine is started.
- ▶ Turn off the water inlet if the washing machine is to be left for any length of time (e.g. while on holiday), especially if there is no floor drain in the immediate vicinity.
- ▶ Make sure that no foreign objects (e.g. nails, pins, coins, paper clips) find their way into the machine with the laundry. Foreign objects can damage components of the machine (e.g. suds container, drum). Damaged components can, in turn, result in damage to the laundry.
- ▶ If the correct amount of detergent is dispensed, the machine should not need to be descaled. If, however, you do wish to descale your washing machine, only use proprietary non-corrosive descaling agents and strictly observe the instructions on the packaging. Special descaling agent is available from Miele. Strictly observe the instructions for the packaging.
- ▶ Solvent-based cleaning agents must not be used.
- ▶ Do not store or use petrol, paraffin or any easily flammable substances near the washing machine. Do not use the machine lid as storage space.

### Risk of fire and explosion!

- ▶ Do not store chemicals (liquid detergents, additives) on the machine lid. They may cause discolouration or lacquer damage. Accidentally spilled chemicals should be removed from the surface immediately with a wet cloth.
- ▶ There are ventilation slots on the back of the machine. The ventilation slots must not be closed or covered under any circumstances. Observe the minimum distance in the installation plan.
- ▶ Only use dyes, dye removers, and descaling agents suitable for use in a washing machine. The manufacturer's instructions on the packaging must be observed.
- ▶ Dye removers contain sulphur compounds which can cause damage such as corrosion. Dye removers must not be used in the washing machine.
- ▶ Avoid contact between stainless steel surfaces and liquid detergents or disinfecting agents containing chlorine or sodium hypochlorite. These agents can cause corrosion on stainless steel. Aggressive chlorine bleach vapour can also cause corrosion. Do not store open containers of these agents near the appliance.

## Warning and Safety instructions

---

- ▶ Do not use a high-pressure cleaner or water jet to clean the washing machine.

### **Chlorine and component damage**

- ▶ Frequent use of chlorine products increases the risk of damage to components.
- ▶ The use of substances containing chlorine, such as sodium hypochlorite and chlorine bleach in powder form, can however result in damage to the protective layer of stainless steel and corrosion on components. Therefore, refrain from using agents containing chlorine. Use oxygen-based bleaching agents instead.

If, however, chlorine bleaching agents are used, an anti-chlorine treatment must always be carried out. Otherwise, the washing machine components and the load may suffer lasting and irreparable damage.

- ▶ Anti-chlorine treatment must be carried out immediately after chlorine bleach has been used. Hydrogen peroxide and oxygen-based detergents and bleaching agents are suitable for anti-chlorine treatment. The suds must not be drained in between.

Treatments with thiosulphates can result in gypsum-like deposits, particularly in combination with hard water. This gypsum can build up in the washing machine or cause incrustations on the laundry.

Treatment with hydrogen peroxide is recommended over treatment with thiosulphates because hydrogen peroxide neutralises chlorine.

The exact dispensing quantities and the treatment temperatures required must be set and tested on site in accordance with the dispensing recommendations of the detergent and additive manufacturers. The laundry must also be tested to check whether it contains any active chlorine residues.

### **Accessories**

- ▶ Only use genuine Miele spare parts and accessories with this machine. Using spare parts or accessories from other manufacturers will invalidate the warranty, and Miele cannot accept liability.

## Caring for the environment

### Disposal of the packing material

The packaging is designed to protect the washing machine from damage during transportation. The packaging materials used are selected from materials which are environmentally friendly for disposal and should be recycled.

Recycling the packaging reduces the use of raw materials in the manufacturing process and also reduces the amount of waste in landfill sites. Ensure that any plastic wrappings, bags etc. are disposed of safely and kept out of the reach of babies and young children. Danger of suffocation!

### Disposing of your old machine

Old electrical and electronic machines often contain valuable materials. However, they also contain harmful substances which were essential for their correct functioning and safety. These could be hazardous to human health and to the environment if disposed of with general waste or if handled incorrectly. Therefore, please do not dispose of your old machine with household waste.

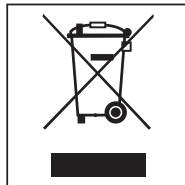

Instead, please make use of officially designated collection and disposal points to dispose of and recycle electrical and electronic machines in your local community. Ask your dealer for more information.

Please ensure that your old machine poses no risk to children while being stored for disposal.

► Ensure that the door locks are unusable when disposing or scrapping old washing machines. This way you will prevent the risk of playing children accidentally locking themselves in and endangering their lives.

Miele cannot be held liable for damage caused by non-compliance with these Warning and Safety instructions.

## Energy saving tips

### Energy and water consumption

- To get the most out of your machine, load the **maximum** dry load size for the wash programme you are using. The most efficient use of energy and water is achieved when a full load is washed.
- If suitable, use programmes from the ECO programme package. The programmes are characterised by particularly low energy consumption.

### Detergent

- Do not exceed the amounts of detergent recommended by the manufacturer on the packaging.
- Reduce the amount of detergent for smaller load sizes.

### When drying the laundry in a tumble dryer

Select the highest possible spin speed for the wash programme to save energy in the subsequent tumble dryer cycle.

# Guide to the machine

## Guide to the machine

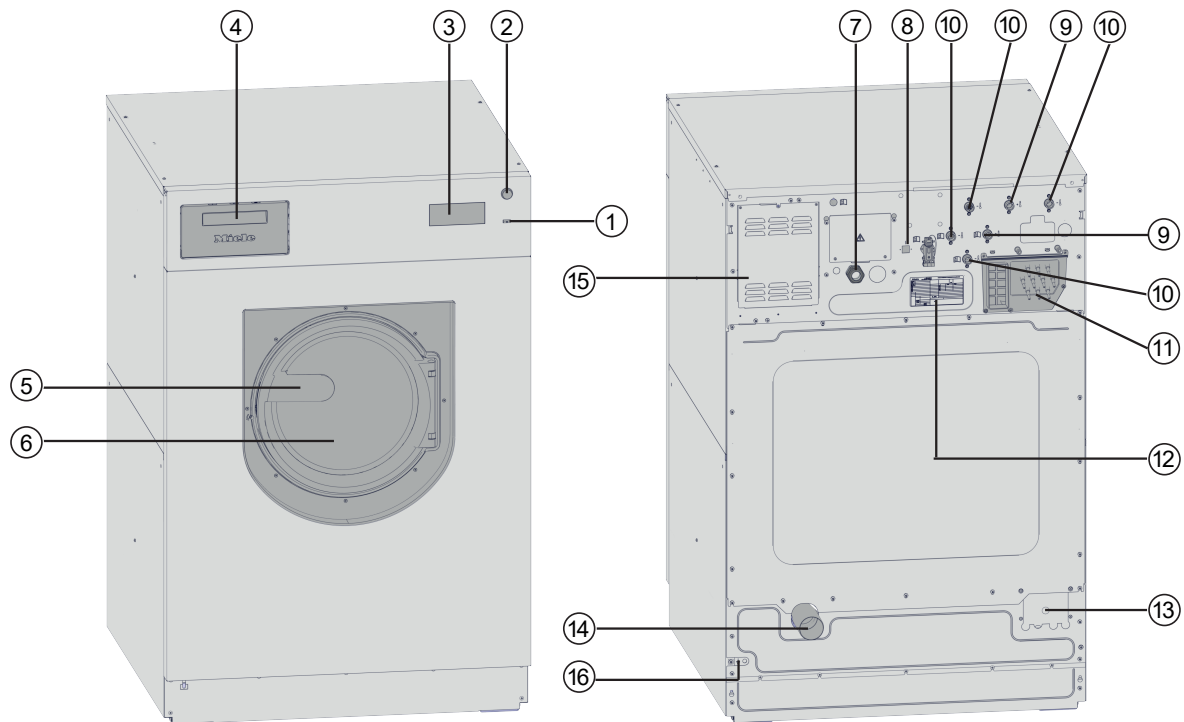

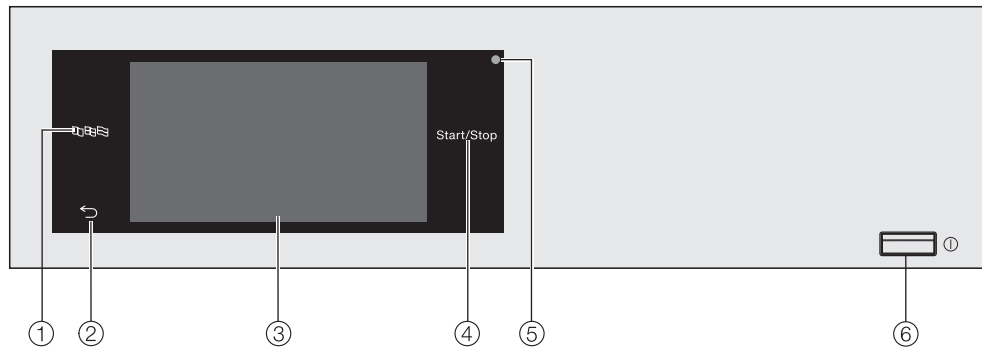

- ① button
- ② Emergency stop
- ③ Display (further information can be found in "Operation")
- ④ Detergent dispenser drawer
- ⑤ Door handle
- ⑥ Drum door
- ⑦ Electrical connection
- ⑧ Interface for Connector Box (optional second interface)
- ⑨ Hot water connection
- ⑩ Cold water connection
- ⑪ Connections for external dispensing agent supply
- ⑫ Data plate
- ⑬ Connection option for direct/indirect steam (depending on model)
- ⑭ Drain connection DN 70
- ⑮ Ventilation slots
- ⑯ Equipotential bonding

## Control panel



- ① **language sensor**  
For selecting the current user language.  
The operating language is displayed again at the end of the programme.
- ② **Back sensor**  
Takes you back one level in the menu.
- ③ **Touch display**
- ④ **Start/Stop sensor**  
For starting the selected wash programme and cancelling a programme that has already started. The programme selected can be started as soon as the sensor starts flashing.
- ⑤ **Optical interface**  
For Miele Professional Service.
- ⑥ **button**  
For switching the washing machine on and off.

## Sensors and touch display

The sensors ,  and *Start/Stop* and the elements in the display respond to fingertip contact. Every touch of the sensors is confirmed by a keypad tone. You can adjust the volume of the keypad tone or switch it off (see “Supervisor level”).

The control panel with the sensors and the touch display can be scratched by pointed or sharp objects, e.g. pens.  
Only touch the control panel with your fingers.

## Main menu

After switching on the washing machine, the main menu will appear in the display.

You can access all important sub-menus from the main menu.

Touch the  symbol at any time to return to the main menu. Values that have not yet been confirmed are not saved when you return to the main menu.

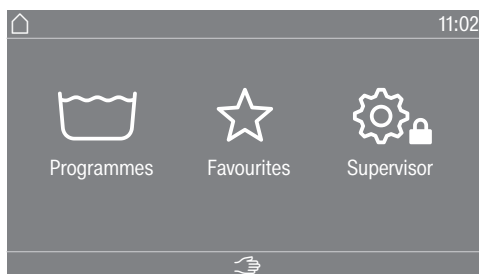

**“ Programmes” menu** In this menu, you can select the wash programmes.

**“ Favourites” menu** In this menu, you can select 1 favourite programme from a total of 24 favourite programmes. The wash programmes can be set up and saved by the supervisor in the Favourites menu (see “Supervisor level - Favourite programmes”).

**“ Supervisor” menu** You can alter the washing machine’s user interface to suit changing requirements in the supervisor level (see “Supervisor level”).

## Examples of how to operate the machine

### Selection lists

#### “Programmes” menu (single selection)

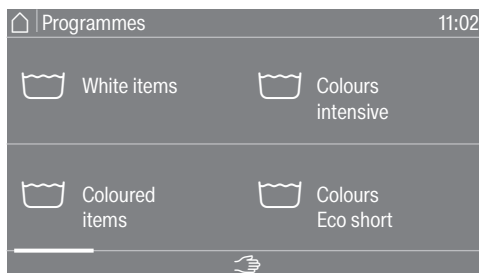

You can scroll to the right or the left by swiping your finger across the screen. To do this, place your finger on the touch display and swipe it in the direction you want.

The orange scroll bar indicates that there are further options to choose from.

Touch a programme name to select a wash programme.

The display will change to the standard menu for that programme.

## “Extras” menu (multiple selection)

In order to access Extras, you must first select a programme, e.g. White items.

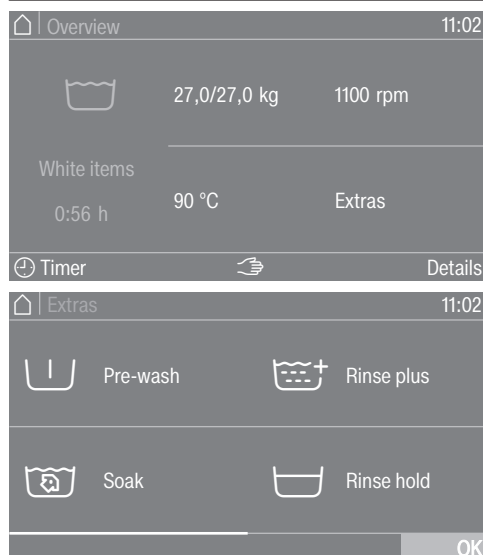

Touch one or several *Extras* to select it/them.

Currently selected *Extras* are marked orange.

To deselect an *Extra*, simply touch the *Extra* again.

Use the *OK* symbol to activate the selected *Extras*.

## Setting numerical values

You can set numerical values in some menus.

The following example shows how to set the time of day. The “Supervisor level” section describes how to get to this level.

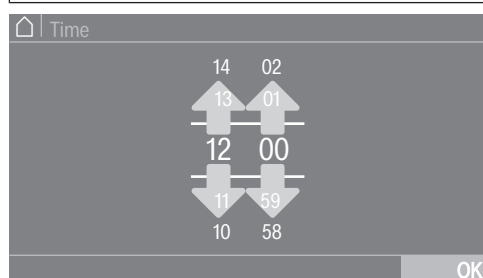

Enter the numbers by swiping upwards or downwards.

Place your finger on the number that you want to change and move your finger in the desired direction. Use the *OK* symbol to accept the set numerical value.

**Useful tip:** With some settings, a value can also be entered using a numerical keypad.

## Operation

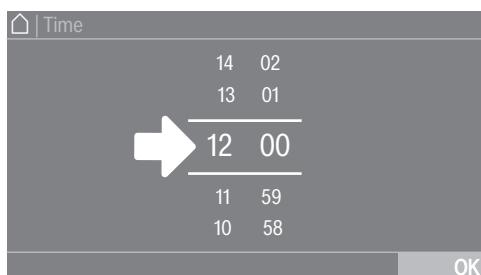

Briefly touching the number between the two lines will bring up the numerical keypad.

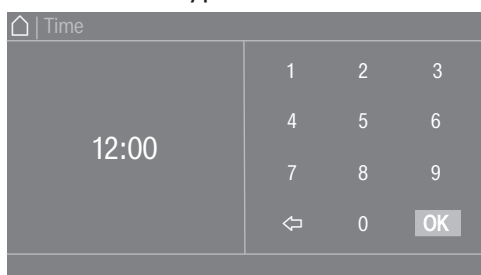

Once a valid number has been entered, the *OK* symbol will be highlighted green.

### Pull-down info

The following example describes the display for an ongoing wash programme. The “Programme start – programme end” section describes how to get to this level.

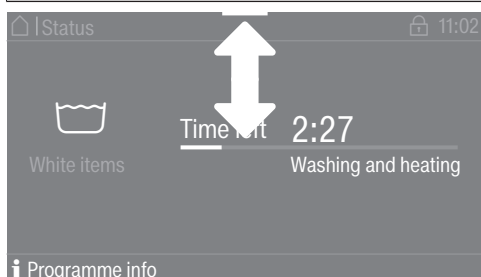

If an orange bar appears at the top of the screen in the middle of the display, you can open the pull-down menu. Drag the bar downwards to display it. To hide it, slide the bar upwards again.

### Exiting a menu

- Touch the ↶ symbol to return to the previous screen.

Entries you have made before this which have not yet been confirmed with *OK* will not be saved.

## Operating the launderette version

The main menu will vary depending on the programming status (see “Supervisor level”).

Shortcuts are the easiest way to operate the machine. Operators cannot change the preset programmes.

### Launderette, basic

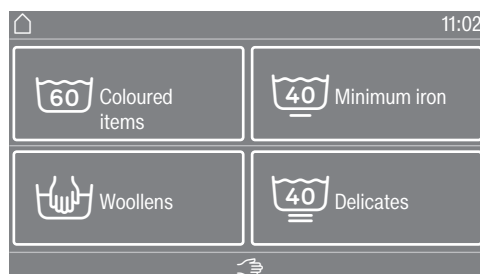

Between 4 and 24 preset programmes are available. These programmes cannot be changed by the operator.

### Launderette logo

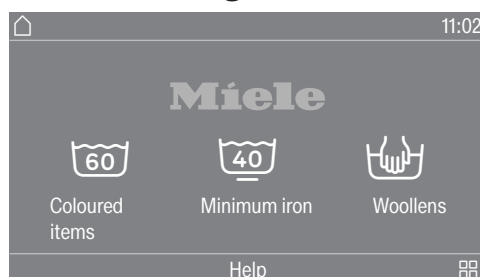

Up to 24 preset programmes are available. The first 3 programmes can be selected directly. The remaining programmes are selected from a list . These programmes cannot be changed by the operator.

# Washing

## Preparing for use

### Emptying pockets

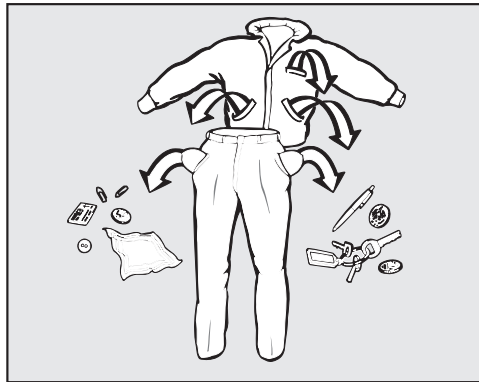

- Empty all pockets.

⚠ Damage due to foreign objects.  
Foreign objects (e.g. nails, coins, paper clips etc.) can cause damage to garments and to components in the machine.  
Check the laundry before washing and remove any foreign objects.

### Sorting the laundry

#### Preparing mops, cleaning cloths, etc.

#### Pre-treating stains

### General tips

- Sort the laundry by colour and by care label.
  - Shake mops, cleaning cloths, and pads out well to get rid of coarse soiling before placing them in the washing machine drum.
  - Clean badly soiled areas and stains on the textiles before washing. Stains should be carefully dabbed off using a soft, colourfast cloth.
- Do not wash any items in this machine which are specified by the manufacturer as not washable on the care label (☒ symbol).
  - Curtains: remove rollers and lead weights or place in a laundry bag.
  - Sew in or remove any loose underwiring in bras.
  - Turn garments inside out, if recommended by the manufacturer.
  - Close any zips and velcro fasteners before washing.
  - Fasten duvet covers and pillow cases to prevent small items from being rolled up inside them.
  - Please refer to the “Programme overview” for more tips.

## Loading and switching on the washing machine

### Loading the washing machine

- Switch on the washing machine with the  button.
- Pull the door handle to open the drum door.
- Unfold the laundry and load loosely in the drum. Mixing both large and small items gives better wash results and helps distribute the load evenly during spinning.

The most efficient energy and water consumption is achieved when a full load is washed. However, do not overload as this reduces cleaning efficiency and causes creasing.

### Closing the drum door

- Close the drum door by pressing it until the pre-latch engages.



 Make sure that no items are caught between the drum door and the sealing ring.

The drum door engages, but is not securely locked yet. The drum door locks automatically as soon as the machine starts.

## Washing with dispenser drawer

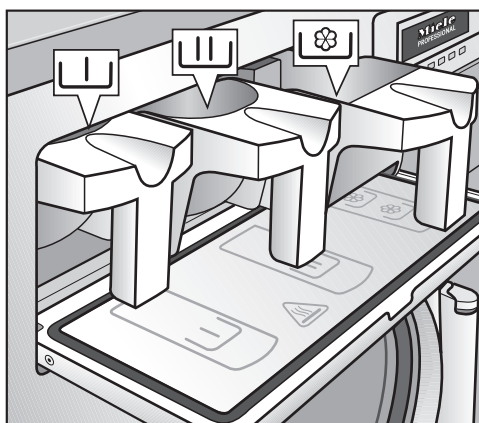
### Adding detergent using the dispenser drawer



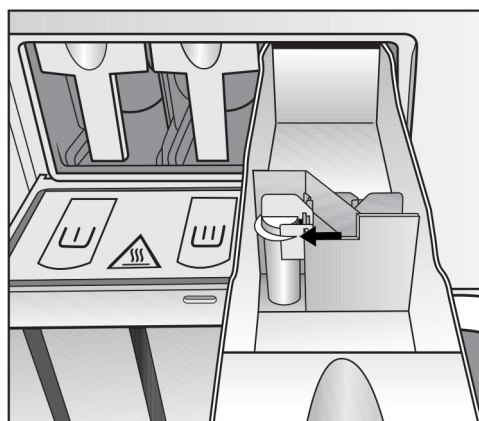

- For standard programmes, add the powder detergent for the main wash to the  compartment and, if desired, add detergent for a pre-wash to the  compartment. Add fabric softener to the front of the  compartment.

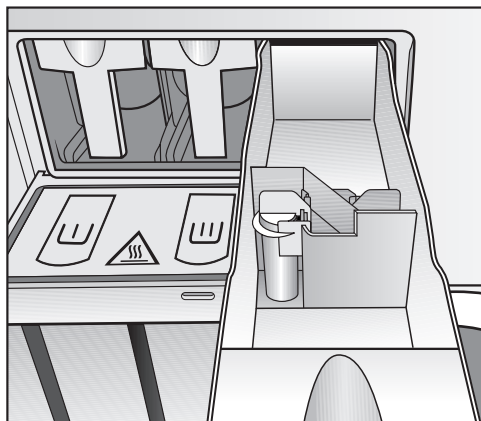

- Add any other liquid agents to the back of the  compartment (if this has been programmed).

## Washing



Do not fill the  compartments above the level marker with liquid agents. Otherwise they will run straight through the siphon into the suds container.

### Bleaching agent

Only use bleach on fabrics with the  $\Delta$  symbol on the wash care label.

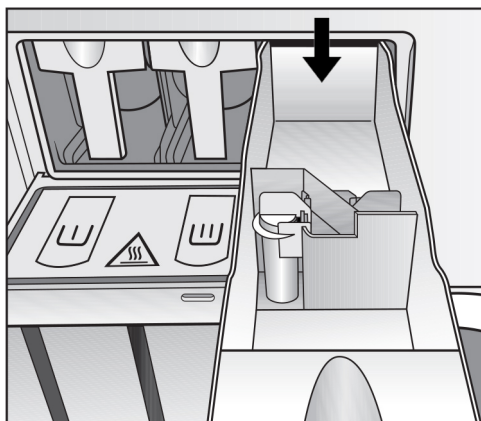

Liquid bleaching agents must only be dispensed through the designated dispensing compartment. Only then can it be guaranteed that the agent will be dispensed automatically during the 2nd rinse. Liquid bleaching agents should only be used on coloured items which have a wash care label stating that they are colour-fast and suitable for bleaching.

 Frequent use of chlorine products increases the risk of damage to components.

### Dyes, dye removers and descaling agents

Proprietary dyes, dye removers and descaling agents may only be used in this machine if the manufacturer expressly states that they are suitable for use in a washing machine. The manufacturer's instructions on the packaging must be observed.

## Detergent dispensing

Avoid dispensing more than the required amount as this can cause excessive foaming.

- Only use low foaming detergents.
- Dispense according to the detergent manufacturer's recommendations.

The amount to dispense will depend on:

- the amount of laundry
- the water hardness
- the degree of soiling of the laundry

## Amount of detergent

Please dispense according to water hardness levels and follow the detergent manufacturer's instructions.

## Water hardness levels

Water hardness range	Hardness in mmol/l	German scale - °dH
soft (I)	0 - 1.5	0 - 8.4
medium (II)	1.5 - 2.5	8.4 - 14
hard (III)	above 2.5	above 14

Check with your local water supplier if you do not know the water hardness level in your area.

## Selecting a programme

### Programmes

There are different ways to select a programme.

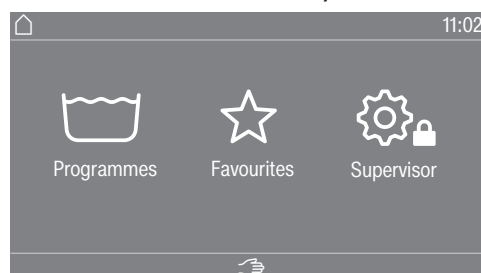

You can select a programme from the Programmes menu.

- Touch the Programmes selection area.

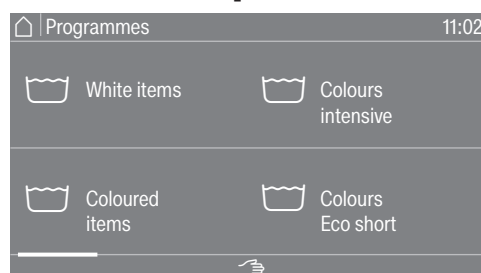

- Scroll to the right in the display until the programme you want appears.
- Touch the required programme in the touch display.

The display will change to the standard menu for that wash programme.

# Washing

## Favourites

Alternatively, you can select a programme from the Favourites menu.

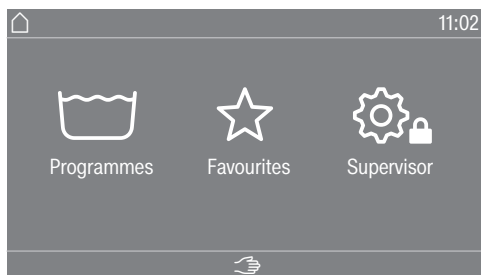

- Touch the Favourites selection area.

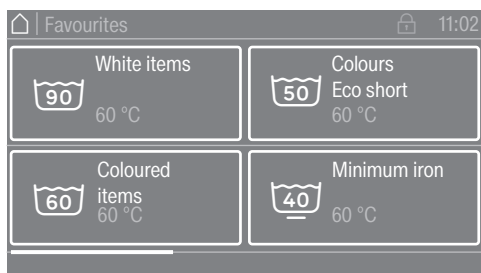

- Scroll to the right in the display until the programme you want appears.
- Touch the required programme in the touch display.

The display will change to the standard menu for that wash programme.

With Favourite programmes, the majority of the programme settings are preset and cannot be changed.

## Selecting programme settings

### Selecting a load size

To enable load-specific external dispensing and an adapted programme sequence, you can specify the load size for some programmes.

- Touch the Weight (kg) selection area.

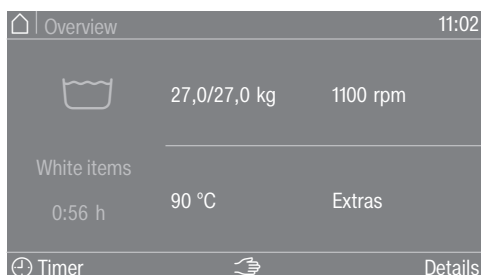

- Enter a valid value for the load size.

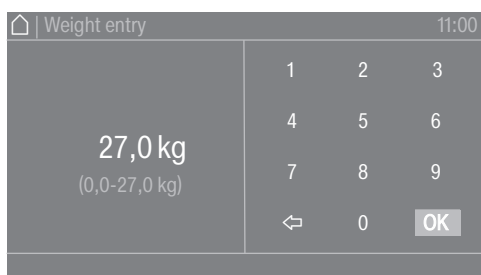

- Touch the OK symbol.

## Selecting the temperature

The display will change to show the Overview menu.

You can alter the preset temperature of the wash programme.

- Touch the Temperature (°C) selection area.

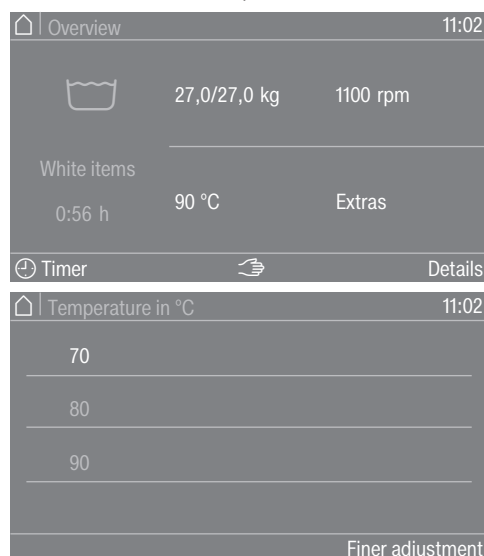

- Select the desired temperature from the presets.

The display will change back to the Overview menu.

If you access the Finer adjustment selection area, you can set further temperatures using direct entry within the available temperature range.

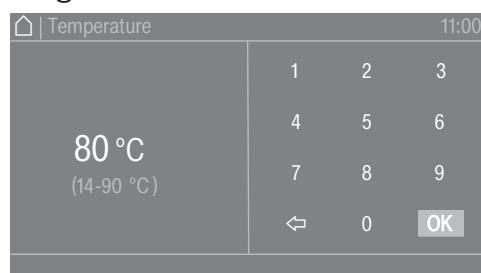

- Select the required value using the keypad.
- Touch the OK symbol.

The display will change back to the Overview menu.

The temperature can only be selected within the range specified below the current setting, e.g. (14–90 °C).

## Selecting a spin speed

You can alter the preset spin speed of the wash programme.

- Touch the Spin speed (rpm) selection area.

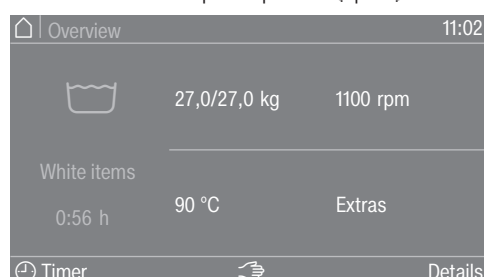

# Washing

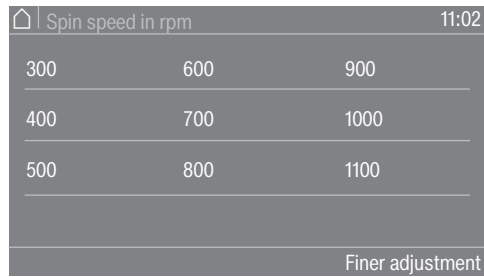

- Select the desired spin speed from the presets.

The display will change back to the Overview menu.

When you access the Finer adjustment selection area, you can set further spin speeds within the spin speed range.

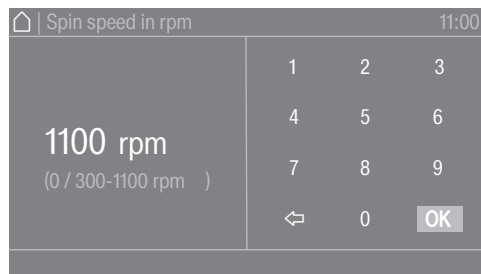

- Select the required value using the keypad.
- Touch the OK symbol.

The display will change back to the Overview menu.

The spin speed can only be selected within the range specified below the current setting, e.g. (0/300–1100 rpm) for PWM 927 and (0/300–1060 rpm) for PWM 935.

## BoostSpin

With certain machine types, the Boost Spin function is activated at the end of a wash programme. This is done so that the laundry has the lowest possible residual moisture due to the maximum spin speed.

BoostSpin is activated ex works but is displayed as **not** visible.

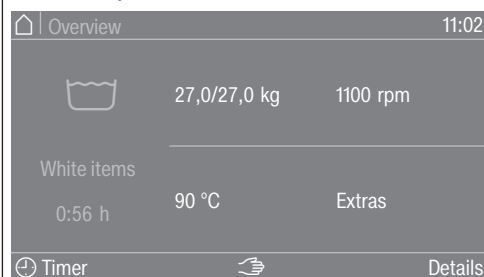

If the Boost Spin function is active and visible, the Extras are displayed under the  symbol.

- Touch the  symbol to select further Extras.

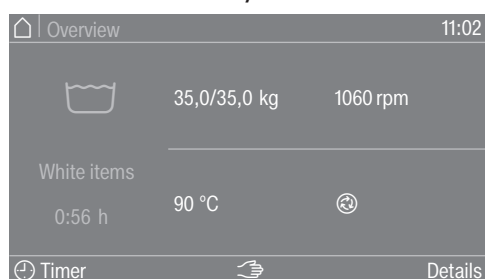

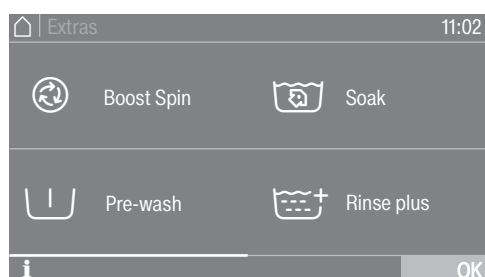

The Boost Spin function cannot be selected or deselected in the Extras sub-menu. The symbol is displayed as active but cannot be changed.

- You can select further Extras.



Information on BoostSpin can be found at **i**.

If the  symbol is to be displayed, this setting can be adjusted at supervisor level. The Extras are then displayed under the  symbol.

- Open the Supervisor level (see “Supervisor level”).
- Open the Controls / Display menu.
- Select Visibility parameters and activate the BoostSpin parameter.

# Washing

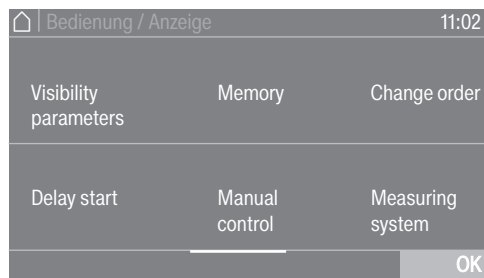

The BoostSpin visibility can be deactivated again in the order specified above.

If the BoostSpin visibility is deactivated, the text under the Extras is no longer displayed. The Extras are displayed again in the overview.

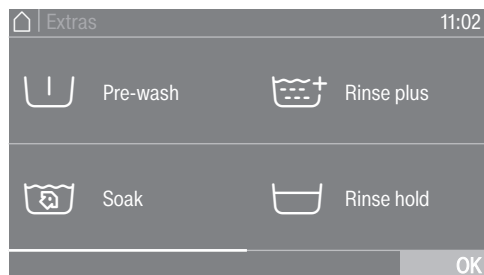



## Selecting Extras

### Selecting Extras

You can select Extras for some wash programmes.

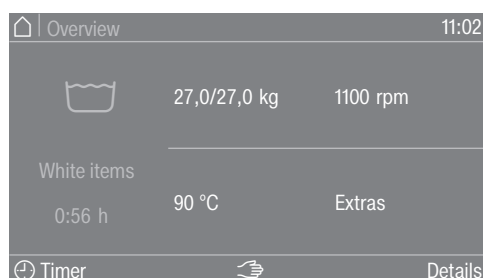
- Touch the Extras selection area.



If the Boost Spin function is active and visible, you can access the Extras by selecting the  symbol.

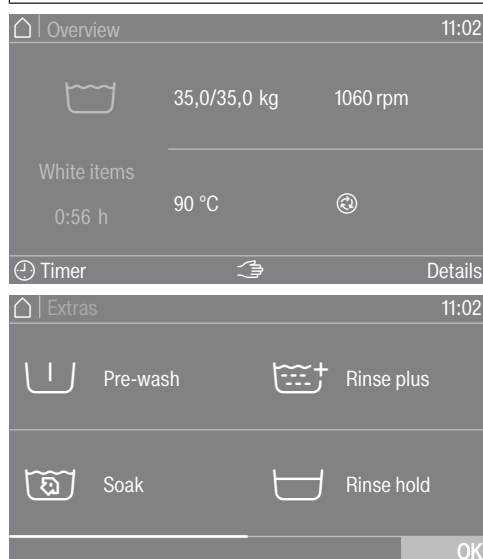

- Select one or more Extras.
- Touch the OK symbol.

The display will change to show the Overview menu.

### Pre-wash

A pre-wash can be added for heavily soiled laundry. Coarse soiling is loosened and removed before the main wash.

### Soak

For heavily soiled fabrics with protein stains. The soaking time is 10 minutes.

### Rinse plus

An extra rinse can be activated to achieve a better wash result.

### Rinse hold

The laundry is not spun after the final rinse and remains in the rinse water. This helps prevent creasing if the laundry is not going to be removed from the drum immediately after the end of the programme.

### Filling stop

Water is drained out of the machine before the last rinse and the programme stops. The required starch, dye, proofing agent, etc. is added directly to the washing machine drum. The programme is continued by touching the *Start/Stop* sensor.

### Intensive

For hard-wearing laundry that is very heavily soiled. The cleaning effect is increased by prolonging the main wash.

# Washing

## Water plus

The water level during washing is increased.

## Programme start – programme end

### Starting a programme

The programme can be started as soon as the *Start/Stop* sensor is flashing on and off.

- Touch the *Start/Stop* sensor control.

The door will lock () and the wash programme will start.

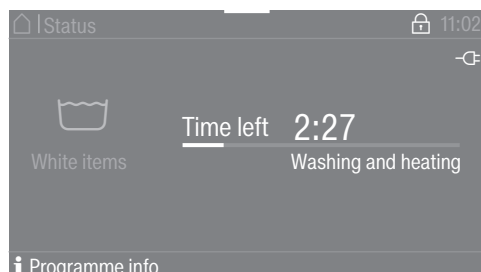

**Useful tip:** You can use the pull-down menu to display the selected temperature, spin speed and any selected Extras.

If a Delay start period () Timer) has been selected, this will appear in the bottom left of the display.

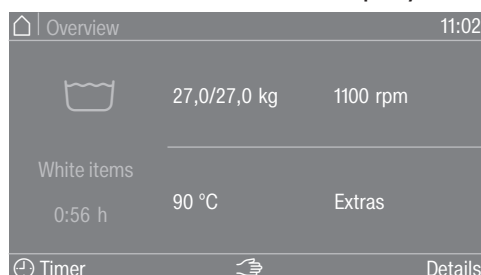

If you select the **i** Programme info selection area, all programme-related information will be displayed.

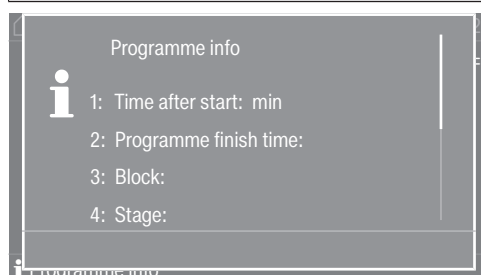

At the end of the Delay start time or immediately after the programme has started, the programme running time will appear in the display. The programme sequence is also shown in the display.

### End of the programme

Depending on the selected setting in the supervisor level or programme, the machine changes to the Anti-crease phase at the end of the programme. The door remains locked. However, the door can be unlocked at any time by touching the *Start/Stop* sensor.

### Removing the laundry

- Pull open the door.
- Remove the laundry.

Items left in the drum could discolour other items in the next wash or become discoloured themselves.

Remove all items from the drum.

- Check the door sealing ring for any foreign objects.

**Useful tip:** For safety reasons, close the door when the washing machine is not in use. Otherwise there is a danger of objects being placed inadvertently in the drum. If these remain unnoticed and were washed in the next load, they could damage the laundry. An open door is also a danger to pets and children.

- Switch the washing machine to standby with the  button.

**Useful tip:** Leave the dispenser drawer slightly open to allow it to dry.

## Timer

The programme start date, programme start time and programme end time can be selected using the timer. This mode is also referred to as Delay start.

### Setting the timer

- Touch the  Timer selection area.

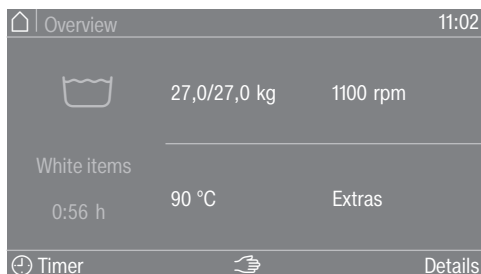

- Select the Finish at, Start date or Start at options.

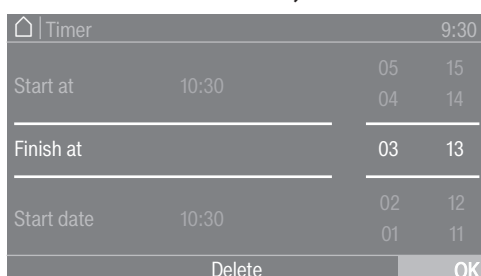

- Set the hours and the minutes or the date and confirm with the OK symbol.

### Deleting the timer

The selected Delay start time can be cancelled before the programme starts.

- Touch the selection area with the selected settings in the timer field, e.g. 01.01. 11:00.

The selected Delay start time will appear in the display.

- Touch the Delete selection area.
- Confirm with the OK symbol.

The selected Delay start time is deleted.

### Starting the timer

- Touch the *Start/Stop* sensor.

The door will lock and the time remaining until the programme starts will appear in the display.

After the programme has started, the selected time can only be changed or cancelled by interrupting the programme.

The programme can be started immediately at any time.

- Touch the Start immediately selection area.

### Spin

#### Final spin speed

After a programme is selected, the maximum spin speed for this wash programme is shown in the pre-start menu.

A reduction of the final spin speed is possible.

Depending on the programme, it may also be possible to increase the speed. The setting options are displayed when you tap the spin speed.

#### Rinse-spin

There is a spin cycle after the main wash and between the rinses. A reduction in the final spin speed will also reduce the rinse-spin speed accordingly.

### Anti-crease

At the end of the programme, the drum continues to turn at intervals for up to 30 minutes to help prevent creasing.

The drum door cannot be opened until the programme has ended.

Anti-crease is programme-dependent. The option can be switched on or off in the supervisor level.

### Skip

The Skip function enables users to skip forwards or backwards in the programme sequence. The programme sequence is continued from the selected step.

If a programme is interrupted using the *Start/Stop* sensor, the Skip  function is available in the programme stop screen.



If the Skip  function is selected, the required programme step can be selected via the display.

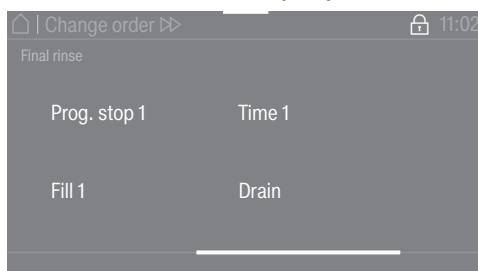

The programme can then be continued with the *Start/Stop* sensor.

### Manual control

Manual control is possible either before a programme is started or when a programme has been stopped.

#### Switching to manual control

- Press the  “Manual control” button to access the password entry screen.

## Special features in the programme sequence

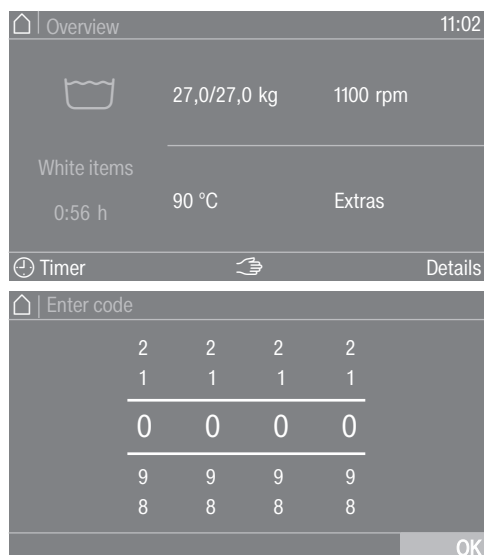

- Enter the password.
- Confirm the password entry with the OK symbol.

The Manual control menu is displayed:

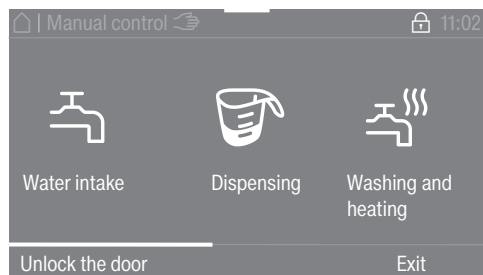

The individual functions of the machine can be selected individually and the parameters can be set.

The current level, spin speed and temperature statuses of the machine appear orange.

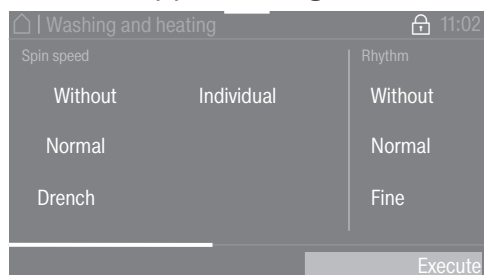





When a function has been selected, the sub-menu for adjusting the parameters appears.

- Select the desired setting.
- Confirm the entry with Execute.

The sub-menus appear in various operating modes. See “Examples of how to operate the machine” for an in-depth description.

## Special features in the programme sequence

The function buttons are assigned with specific manual control functions:

- Water inlet 
- Dispensing 
- Washing and heating 
- Drain with drum rotation 
- Spin 

- Press the button again to end a selected function.

### Water intake

Water intake valves and the water level can be set.

- Press the  Water intake function button.
- Select the desired value.
- Confirm your selection with the Execute sensor control.

If a higher numerical value is set, the values below this will no longer be displayed.

The wash programme will start or continue.

### Dispensing

The dispensing quantity for the various dispenser pumps can be set.

This function is only possible if the Connector Box, the dispenser pumps and automatic dispensing have been selected in the supervisor level (see “Supervisor level” section).

- Press the  Dispensing function button.
- Select the desired dispenser pump and dispensing quantity, e.g. D1 50 ml.
- Confirm your selection with the Execute sensor control.

The wash programme will start or continue.

### Washing and heating

Spin speed, rhythm and temperature can be set.

- Press the  Washing and heating function button.
- Select the desired settings.

The selected setting will appear in orange in the multiple selection.

- Confirm your selection with the Execute sensor control.

The wash programme will start or continue.

### Drain with agitation

Drain path, spin speed, and rhythm can be set.

- Press the Drain with agitation  function sensor.
- Select the desired settings.

The selected setting will appear in orange in the multiple selection.

- Confirm your selection with the Execute sensor.

### Spin

The spin speed can be set.





- Press the  Spin function button.
- Select the desired value.
- Confirm your selection with the Execute sensor control.

The wash programme will start or continue.

## Special features in the programme sequence

### Function combinations

Water inlet, dispensing, washing and heating can be selected simultaneously in any combination\*.

 Water intake	 Dispensing	 Washing and heating	 Drain with agitation	 Spin
<input checked="" type="checkbox"/>	<input checked="" type="checkbox"/>	<input type="checkbox"/>	<input type="checkbox"/>	<input type="checkbox"/>
<input type="checkbox"/>	<input checked="" type="checkbox"/>	<input checked="" type="checkbox"/>	<input type="checkbox"/>	<input type="checkbox"/>
<input checked="" type="checkbox"/>	<input type="checkbox"/>	<input checked="" type="checkbox"/>	<input type="checkbox"/>	<input type="checkbox"/>
<input checked="" type="checkbox"/>	<input checked="" type="checkbox"/>	<input checked="" type="checkbox"/>	<input type="checkbox"/>	<input type="checkbox"/>

\* possible function combinations

### Weighing system

If the machine is equipped with a weighing plinth, the laundry load size is displayed in 0.2 kg increments during loading. The maximum load size for the selected programme is displayed beside it.

### Resetting the load display to zero

Do not place items on the machine. Do not lean against the machine.

This can influence the result of the measurement.

If the load display does not show “0.0” with an empty drum, set the tare to 0 using the Tare button.

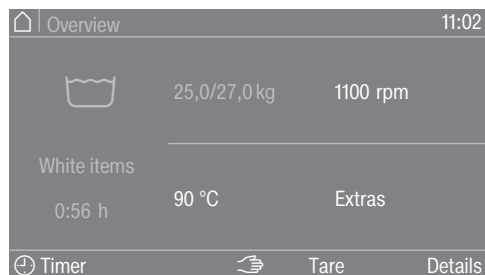

- If after resetting to 0 (taring), you remove an overlooked item from the drum, the following will appear in the display:

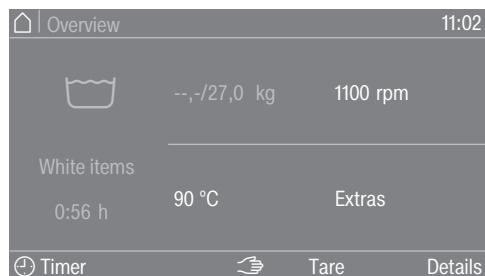

- Reset the display to 0 using the Tare button.

**Useful tip:** If the machine is overloaded, for example when laundry is wet, it will operate in accordance with the nominal load after the programme starts. This value is also saved in the operating data module.

If the weighing system is not working correctly, a message is displayed. The nominal load of the machine is assumed. The weight input can be entered manually.

# Changing the programme sequence

## Changing a programme

### Altering the wash programme

Before selecting a new programme, cancel the current programme and select a new one.

### Interrupting a programme

You can cancel a wash programme at any time after it has started.

If the programme is locked, the disinfection programmes or payment programmes can only be cancelled by entering a code.

- Touch the *Start/Stop* sensor control.

The following will appear in the display:

**i** Programme stopped. Continue by pressing "Start/Stop".

The following will appear in the display:



- Select Finish.

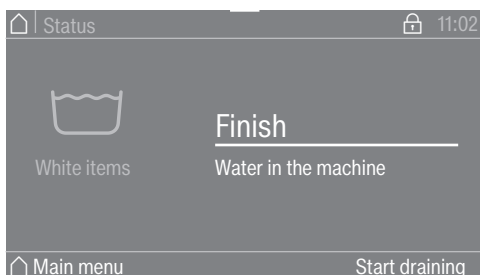

The suds are not drained so they can be used again in a subsequent programme. After the programme has finished, the display for the programme end mask/programme end screen will appear. It is possible to change to the main menu with the suds in the machine or drain the suds by pressing the Start draining selection field. If permanent automatic water drainage is required, Automatic drainage can be activated at supervisor level.

The drum door remains closed while water is in the machine.

The door can be opened under the condition Programme end without water. If the temperature is too high, wait until it has cooled down so that the door can be opened.

- Wait until the door unlocks.
- Pull open the door.
- Remove the laundry.

### Switching on the washing machine after a power failure

If the washing machine is switched off with the  button during a wash programme, the programme will be interrupted.

- Switch the washing machine back on with the  button.
- Note the message in the display.
- Touch the *Start/Stop* sensor.

## Changing the programme sequence

### Adding or removing laundry

The programme will continue.

You can add or remove laundry items for a short period immediately after the programme has started.

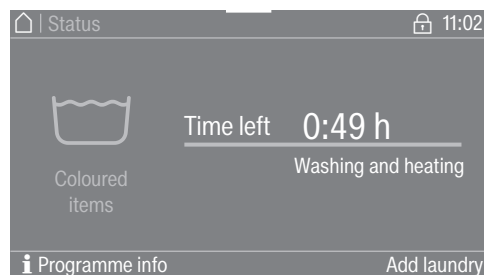

- Touch the Add laundry selection area.

If the message Add laundry is not visible in the display, then it is no longer possible to add items of laundry.

The wash programme will stop and the door will unlock.

**⚠ Risk of chemical burns from detergent.**  
When adding or removing laundry during the main wash, your skin may come into contact with detergent, particularly if the detergent is dispensed externally.  
Take care when placing your hands inside the drum.  
If suds have come into contact with the skin, rinse off immediately with lukewarm water.

- Pull open the door.
- Add laundry or remove individual items.
- Close the door.
- Touch the *Start/Stop* sensor.

The wash programme will continue.

## Problem solving guide

### Problem solving guide

#### Power cut during the wash process

- Disconnect the machine from the mains electricity supply (see “Safety notes”).
- Close the on-site supply valves for water or steam, depending on heating type.

If there is water in the machine, first the drain valve must be opened manually and then the drum door manually unlocked to remove the laundry.

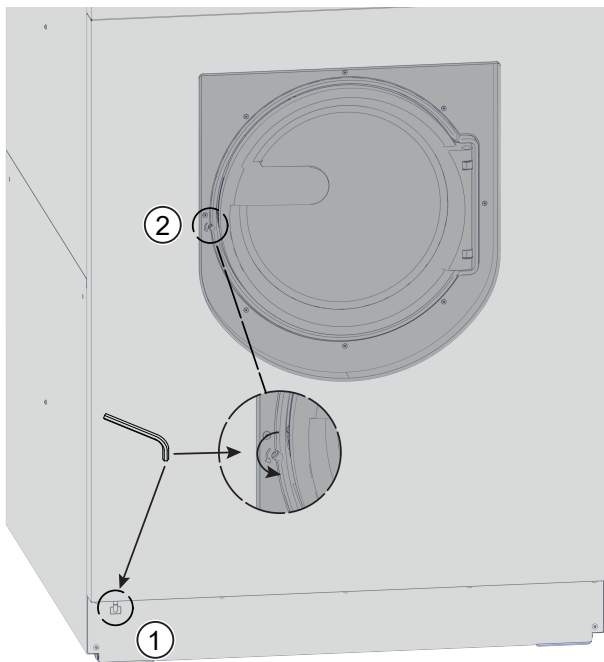

- Guide the T 40 Torx wrench for the emergency door release through the eye ① on the front of the machine.
- Open the drain valve by pulling the eye ② using the Torx wrench.
- Keep pulling the eye until the suds have drained away completely.

The suds will drain away.

The emergency drain closes automatically when the Torx wrench is removed from the eye.

- Push the eye ② back in as far as it will go.

#### Unlocking the door

The drum door cannot be opened in the event of a power cut.

**⚠ Danger from rotating drum and danger of scalding.**

Before inserting the Torx wrench, make sure that the machine is disconnected from the electricity supply, the drum has stopped and there is no water in the machine.

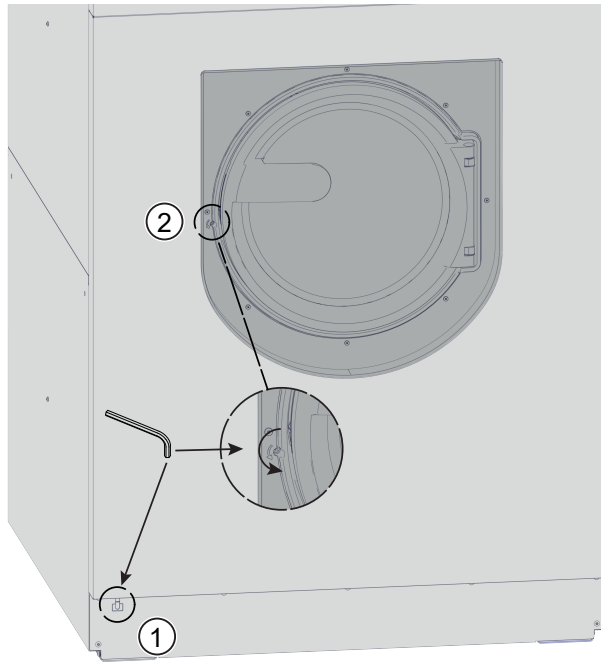

- Using a T 40 Torx wrench, turn the release element with the inner hexagon ② two whole revolutions **anti-clockwise in the direction of the arrow**.

**Useful tip:** Pushing on the door at the same time makes it easier to turn the emergency release mechanism.

The release element is located opposite the door catch at the same height as the handle (see illustration).

The release element must not be turned against the direction of the arrow.  
The door lock will be damaged.

The turn resistance will noticeably reduce. When the emergency release element moves freely, the door is unlocked.

**Useful tip:** It is not necessary to screw the emergency release element back in.

The door can now be opened.

Suitable protective clothing  
Suitable protective clothing must be worn when unloading the drum.

# Problem solving guide

## Contact in case of fault

In the event of any faults which you cannot remedy yourself, please contact Miele Professional Service.

Contact information for Miele can be found at the end of this booklet.

Please quote the model and serial number of your appliance when contacting Miele. This information can be found on the data plate.

The data plate is on the back of the machine at the top and on the inside of the drum door.

## Problem solving guide

With the help of the following guide, minor faults in the performance of the appliance, some of which may result from incorrect operation, can be remedied without contacting Miele. This will save you time and money because you will not need a service call.





Please note, however, that a call-out charge will be applied to unnecessary service visits where the problem could have been rectified as described in these operating instructions. You should, however, note the following:

 Repair work to electrical appliances must only be carried out by a suitably qualified technician in strict accordance with current local and national safety regulations. Unauthorised or incorrect repairs could cause personal injury or damage to the appliance.



## The programme does not start

Problem	Possible cause and remedy
<b>The display remains dark, and the <i>Start/Stop</i> sensor does not light up or flash.</b>	There is no power to the washing machine. <ul style="list-style-type: none"> <li>■ Check whether the washing machine is switched on.</li> <li>■ Check whether the washing machine is connected to the electricity supply.</li> <li>■ Check whether the circuit breaker has tripped.</li> </ul>
	The washing machine has switched off automatically to save energy. <ul style="list-style-type: none"> <li>■ Switch the washing machine back on with the  button.</li> </ul>
<b>The following appears in the display: F - Door lock fault.</b> You can continue by pressing the "Start/Stop" button.	The door has failed to lock. <ul style="list-style-type: none"> <li>■ Close the door again.</li> <li>■ Start the programme again.</li> </ul> If the fault message appears again, contact Miele Professional Service.
<b>The display is dark and the <i>Start/Stop</i> sensor is flashing slowly.</b>	If the standby function has been activated at supervisor level, the display switches off automatically to save energy. <ul style="list-style-type: none"> <li>■ Touch any sensor. The display will switch on again.</li> </ul>
<b>The programme is in the pre-start screen and the <i>Start/Stop</i> sensor flashes.</b>	The drum door is only ajar, but not correctly closed. <ul style="list-style-type: none"> <li>■ Check whether the drum door is closed correctly.</li> </ul>

## Programme cancellation and fault message

Problem	Possible cause and remedy
 F - Drainage fault. If machine restart is unsuccessful, call Miele.	The drain is blocked or restricted. <ul style="list-style-type: none"> <li>■ Check the drain paths and clean them if necessary.</li> </ul>
 F - Water intake fault. If machine restart is unsuccessful, call Miele.	The water inlet is blocked or restricted. <ul style="list-style-type: none"> <li>■ Check whether the water inlet is turned on properly.</li> <li>■ Check the water inlet hoses for leaks.</li> <li>■ Check whether the water connection pressure is sufficient.</li> <li>■ Check whether the water inlet hoses are kinked.</li> </ul>
	The water inlet filters are blocked. <ul style="list-style-type: none"> <li>■ Clean the filters.</li> </ul>
 Disinfection temperature not reached	The required temperature was not reached during the disinfection programme. <ul style="list-style-type: none"> <li>■ The washing machine has not carried out the disinfection cycle correctly.</li> <li>■ Restart the programme.</li> </ul>
 Fault F. If restart fails, call Miele.	There may be a fault. <ul style="list-style-type: none"> <li>■ Disconnect the washing machine from the electricity supply.</li> <li>■ Wait at least 2 minutes before reconnecting the washing machine to the electricity supply.</li> <li>■ Then switch the washing machine on again.</li> <li>■ Restart the programme. If the fault message appears again, contact Miele Professional Service.</li> </ul>
Emergency release. Programme stopped. Please close the door and switch the machine off and then back on again.	The door emergency release has been activated. <ul style="list-style-type: none"> <li>■ Close the door and switch the machine off and on.</li> </ul> <p>The interrupted programme can be continued once the machine has been restarted.</p>

## There is a message in the display

Problem	Possible cause and remedy
 Container empty	One of the liquid dispensing detergent containers is empty. <ul style="list-style-type: none"> <li>■ Refill the detergent containers.</li> </ul>
 Dispensing container. Continuing without automatic dispensing via "Start/Stop" is possible.	One of the liquid dispensing detergent containers is empty; the programme is stopped. <ul style="list-style-type: none"> <li>■ Refill the detergent container and press the Start/Stop button to continue the wash programme.</li> <li>■ If it is not possible to refill the detergent container, press the Start/Stop button to continue the wash programme without detergent.</li> </ul> <div style="border: 1px solid gray; padding: 5px; margin-top: 10px;"> <p>Insufficient disinfection  Disinfection programmes must be cancelled as no disinfectant can be added.</p> </div>

## Problem solving guide



Problem	Possible cause and remedy
<b>i</b> Hygiene info: run a programme of at least 60°C	During the last wash, a wash programme with a temperature below 60 °C was selected. <ul style="list-style-type: none"> <li>■ Start a programme with a minimum temperature of 60 °C or the Clean machine Extras Intensive programme.</li> </ul>
Weighing system defective. Please enter the weight manually.	The weighing system is defective. <ul style="list-style-type: none"> <li>■ Enter the weight manually.</li> </ul>

### Insufficient wash results

Problem	Possible cause and remedy
<b>Liquid detergent does not give the required result.</b>	Liquid detergents usually contain no bleaching agents. They do not remove fruit, coffee and tea stains. <ul style="list-style-type: none"> <li>■ Use a general purpose powder detergent containing a bleaching agent.</li> <li>■ Pour stain remover powder into compartment  of the dispensing drawer and liquid detergent into a dispenser ball.</li> <li>■ Never put stain remover powder and liquid detergent together in the dispenser drawer.</li> </ul>
<b>White residues which look like powder detergent are seen on dark textiles after washing.</b>	The detergent contains compounds (zeolites) to aid water softening which are not soluble in water. These have ended up on the laundry. <ul style="list-style-type: none"> <li>■ Try to brush off the residues with a soft brush once the laundry is dry.</li> <li>■ Wash dark textiles using a detergent which contains no zeolites. Liquid detergents do not usually contain zeolites.</li> </ul>
<b>Textiles that were very greasy are not properly clean.</b>	<ul style="list-style-type: none"> <li>■ Select a programme with pre-wash. Use liquid detergent for the pre-wash.</li> <li>■ Continue to use universal powder detergent for the main wash.</li> </ul>
	The use of heavy-duty detergent is recommended in the main wash for very heavily soiled work clothing. Please seek advice from the detergent manufacturer.
<b>Grey, greasy particles cling to washed laundry.</b>	Insufficient amounts of detergent were used. The laundry was heavily soiled with grease (oils, ointments). <ul style="list-style-type: none"> <li>■ Use more detergent or liquid detergent with this type of soiled laundry.</li> <li>■ Before washing the next load, run a 60 °C programme with liquid detergent but without a load.</li> </ul>

### General problems with the washing machine

Problem	Possible cause and remedy
<b>The washing machine vibrates during the spin cycle.</b>	The machine is not standing evenly. <ul style="list-style-type: none"> <li>■ The washing machine must be secured to the floor on site according to the instructions on the installation plan.</li> </ul>

Problem	Possible cause and remedy
<b>Large amounts of detergent residues remain in the dispenser drawer.</b>	The water flow pressure is too low. ■ Clean the water inlet filters.
	Powder detergent used in conjunction with water softeners tends to become sticky. ■ Clean the detergent dispenser drawer and, in the future, add washing powder to the dispenser drawer first, and then add the water softener.
<b>Fabric softener is not completely dispensed or too much water remains in the  compartment.</b>	The siphon tube is not correctly positioned or is clogged. ■ Clean the siphon (see “Cleaning and care – Cleaning the detergent drawers, detergent compartments and siphons”).
<b>The display is in a different language.</b>	A different language has been selected. ■ Switch the washing machine off and then on again. The selected supervisor language appears in the display.
	The supervisor language has been changed. ■ Select the language you require (see “Supervisor level – Language”).
<b>The washing machine did not spin the laundry as usual. The laundry is still wet.</b>	The machine detected an imbalance during the final spin and reduced the spin speed automatically. ■ Include both large and small items in the load as this will give better distribution.
<b>The drum remains stationary but the programme keeps running.</b>	Fault in the programme sequence. ■ Switch the washing machine off and then back on with the  button. ■ Note the message in the display. ■ Touch the <i>Start/Stop</i> sensor. The programme will continue and the drum will spin.

## Problem solving guide

### The door will not open or close

Problem	Possible cause and remedy
<b>The door will not open.</b>	There is no power to the washing machine. <ul style="list-style-type: none"> <li>■ Check whether the washing machine is switched on.</li> <li>■ Check whether the washing machine is connected to the electricity supply.</li> <li>■ Check whether the circuit breaker has tripped.</li> </ul>
	Power cut <ul style="list-style-type: none"> <li>■ Open the drum door as described in “Troubleshooting”.</li> </ul>
	The water in the washing machine cannot be drained. <ul style="list-style-type: none"> <li>■ Check whether the drainage system is blocked. Clean the drainage system.</li> </ul>
	The door is locked during the wash process. <ul style="list-style-type: none"> <li>■ Touch the <i>Start/Stop</i> sensor control.</li> <li>■ Select Programme cancellation or Add laundry.</li> </ul> <p>The door will unlock and you will be able to pull it open.</p>
	To protect the user against scalding, the drum door cannot be opened if the suds temperature is higher than 50 °C.
Cooling down <b>appears in the display at the end of the programme or after a programme has been cancelled.</b>	To protect the user against scalding, the door cannot be opened if the suds temperature is higher than 50 °C. <ul style="list-style-type: none"> <li>■ Wait until the temperature in the drum has decreased and the message has gone out in the display.</li> </ul>
<b>The following appears in the display:</b> F -Door lock fault. Call Miele.	The door lock has jammed. <ul style="list-style-type: none"> <li>■ Call Miele.</li> </ul>

### Continuing a programme after an interruption to the power supply

If a running programme is interrupted, e.g. by a power cut, the programme can be continued when power is restored.

- Switch on the washing machine with the  button.
- Then press the "Start/Stop" sensor and follow the instructions in the display.

The programme will then continue with the next stage of the last active programme sequence.

- Carry out cleaning and maintenance of the machine after use if possible.

Do not use a pressure washer or hose to clean the machine.

- Clean the **machine casing, control panel and plastic parts** with a mild, non-abrasive detergent or with a soft damp cloth only. Wipe dry with a soft cloth.

Scouring agents will scratch the surface.

- Clean stainless steel casing with a proprietary stainless steel cleaner.
- Remove any deposits from the door seal with a damp cloth.

Do not allow cleaning agents to penetrate the electrical components.

- When disinfecting the surfaces, use a damp cloth only to clean the front and around the door lock. Do not spray any liquids.

### **Build-up of rust**

The drum is manufactured from rust-free stainless steel. Water or foreign objects containing ferrous substances (e.g. paper clips, metal buttons or metal splinters) which are placed in the machine with the laundry can cause a build-up of rust in the drum. Clean the drum regularly in this case and if rust occurs, remove it immediately with a proprietary stainless steel conditioner. Check the door seals for ferrous residues and clean thoroughly as described above. This must be carried out regularly.

### **Cleaning the detergent drawers, detergent compartments and siphons**

- Clean the detergent drawer and the detergent compartments thoroughly with hot water as required to remove detergent residues and incrustations.
- If the machine is not going to be used for a longer time, leave the flap of the detergent drawer open.
- Also clean the siphons in the detergent compartments.

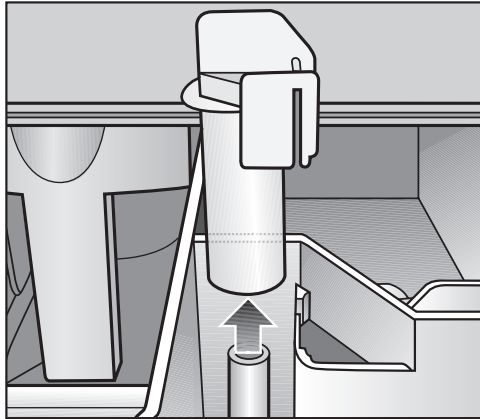

- Remove the siphon. Clean the siphon with hot water and reinsert it.

### Cleaning the drip channel and siphon

- Open the flap on the detergent drawer to an angle of 45° and lift out the flap of the detergent drawer upwards on the right side.

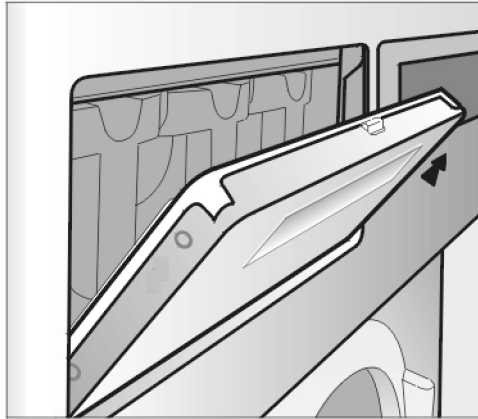

If the drip channel and its drain connector are blocked, then these should be cleaned.

- Check the grille of the suds container ventilation on the back of the machine for soiling from time to time and clean if necessary.

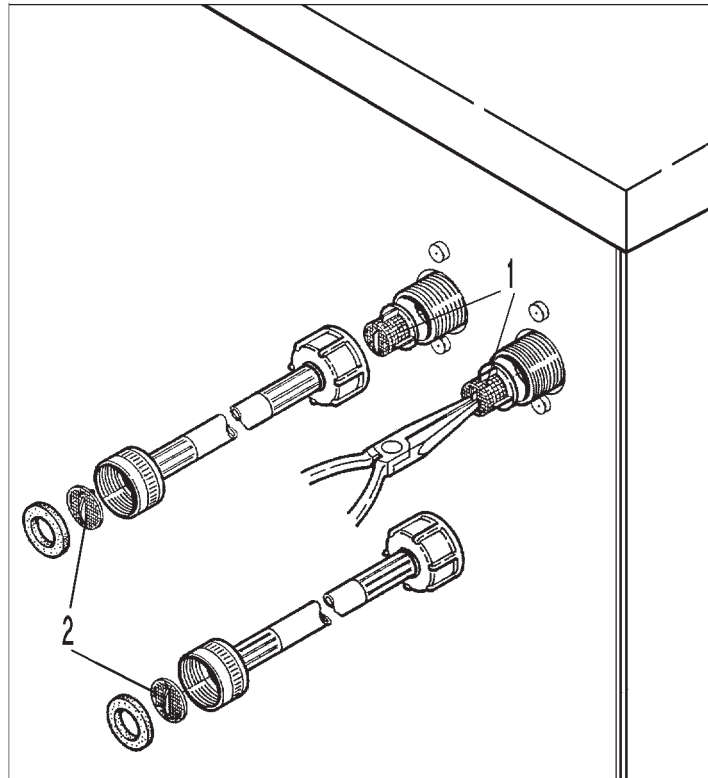

- The filters in the water inlet valves (1) and the inlet hoses (2) must be checked for soiling from time to time and cleaned if necessary.

## Installing the washing machine

The washing machine must be installed by a Miele authorised installer. Please observe the instructions in the installation plan.

This washing machine is only intended for items of laundry that have not been proofed with dangerous or inflammable substances.

- To avoid the risk of frost damage, the washing machine must not be located in rooms which may be subject to very low temperatures.
- Transport the machine on a pallet truck inside the room.
- Remove the packaging carefully with a suitable tool.
- Lift the machine off the truck using a lifting device.

## Securing the machine

- The washing machine must be secured to the floor using the fixtures and fastenings supplied.

The fastening material provided is intended for use in bolting the machine to a concrete floor. If other floor types are present at the installation site, the fastening material must be ordered separately.

## General operating conditions

This washing machine is intended only for use in a commercial environment and must only be operated indoors.

- Ambient temperature: 0-40 °C
- Relative humidity: non-condensing
- Maximum height above sea level of installation site: 2000 m

Depending on the nature of the installation site, sound emissions and vibration may occur.

**Useful tip:** Have the installation site inspected and seek the advice of a professional in instances where increased noise may cause a nuisance.

## For easy maintenance

For ease of future maintenance and servicing by Miele Professional Service, the minimum dimensions and distance to the wall must be observed to enable access.

- Observe the specified minimum dimensions and distance to the wall and ceiling.

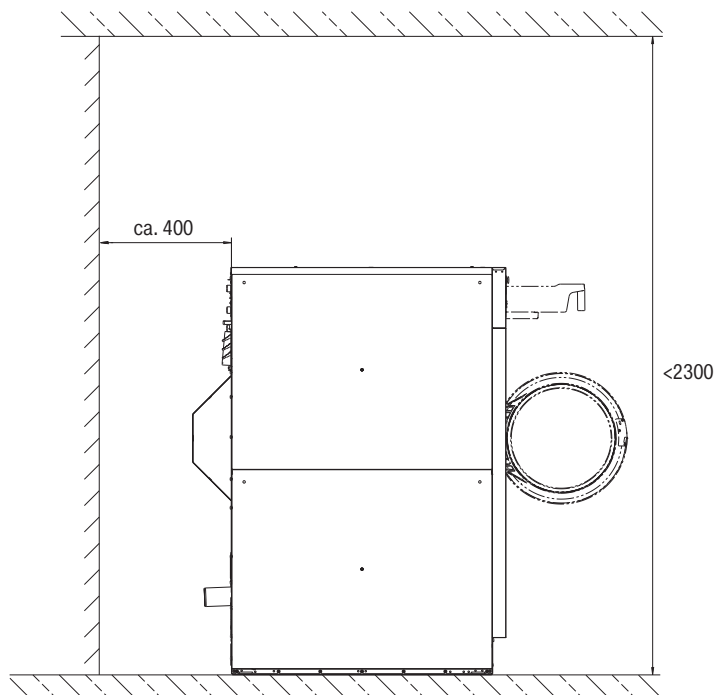

Dimensions in millimetres

Minimum distance to the wall approx. 400 mm to allow for maintenance. The ceiling height must be at least 2300 mm.

- Adjust the washing machine until it is level.

The washing machine must be completely level to ensure smooth operation.

## Water connection

Water pressure (water connection pressure) of a minimum of 100 kPa (1 bar)/maximum of 1000 kPa (10 bar) is required to guarantee a problem-free programme sequence.

The machine must be connected to the water supply using the water inlet hoses provided.

This appliance must be connected to the water supply in strict accordance with local and national requirements (e.g. Plumbing Code of Australia (PCA)). This appliance must be installed according to AS/NZS 3500.1 and AS/NZS 3500.2. This washing machine has been supplied with a separate backflow prevention device (dual check valve). The dual check valve supplied separately with this product must be installed between the tap and the water inlet hose. Screw the dual check valve onto the tap. Then screw the water inlet hose onto the thread of the dual check valve, or screw the Y-piece, followed by the water inlet hoses to the dual check valve if connecting two hoses to the same tap. Turn on the tap gradually to test for leaks. If there is a leak, the connection might not be on securely, or it may have been screwed on at an angle. Unscrew and reconnect the water correctly before tightening it.

Hoses must be replaced with hoses tested for a burst pressure of at least 7000 kPa (70 bar) overpressure and for water temperatures of a minimum of 90 °C.

This also applies for associated connection fittings. Original spare parts meet these requirements.

**Useful tip:** The warm water supply must not exceed a maximum temperature of 70 °C. For machines with reduced heater rating and external heating (depending on country), the incoming warm water must not exceed a temperature of 90 °C. Special hot water connection hoses must be used for this purpose.

This appliance must be connected to the water supply in strict accordance with local and national requirements (e.g. Plumbing Code of Australia (PCA)). This appliance must be installed according to AS/NZS 3500.1 and AS/NZS 3500.2.

The flow pressure must amount to a minimum of 100 kPa and must not exceed 1000 kPa. If the flow pressure is higher than 1000 kPa, a pressure reducing valve must be used. The machine must be connected to the water supply using the inlet hoses provided.

## Steam connection (depending on country)

For steam-heated machine variants, the steam connection must only be carried out by an authorised installation technician. The steam valve and condensate trap are available from Miele.

This appliance must be connected to the water supply in strict accordance with local and national requirements (e.g. Plumbing Code of Australia (PCA)). This appliance must be installed according to AS/NZS 3500.1 and AS/NZS 3500.2. This washing machine has been supplied separately with backflow prevention devices (dual check valves). For water connection, the backflow prevention devices (dual

check valve) must be used. The backflow prevention device prevents back siphoning and must be installed between the tap and water inlet hose.

- Attach the back flow prevention device - Then screw the water intake hose onto the thread of the backflow prevention device - Turn on the tap gradually to test for leaks. If there is a leak, the connection might not be securely on. It may have been screwed on at an angle. Unscrew and reconnect the water correctly before tightening it.

## Dispenser pump connections

Up to 12 dispenser pumps can be connected to the washing machine.

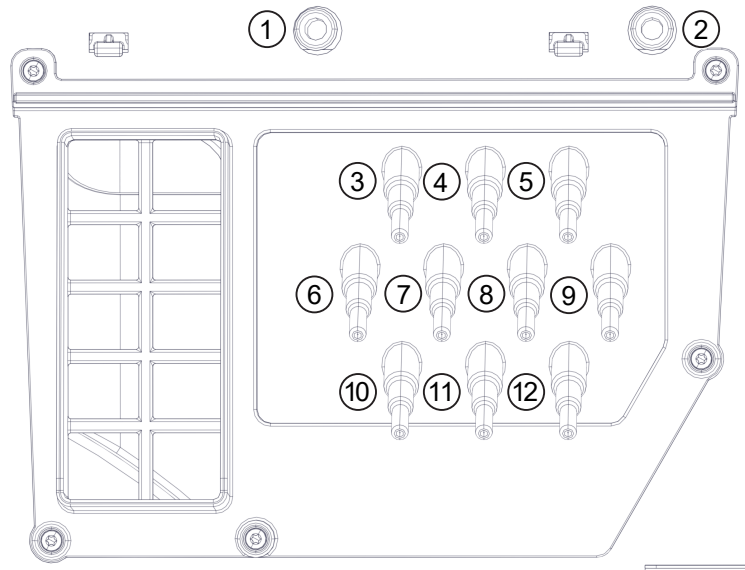

Dispenser pump connections on the back of the machine

Connections **1** and **2** are provided for viscous agents and can also be used for high-pressure dispensing systems with water injection. The dispensing systems must comply with all relevant local and national regulations. The maximum flow rate is 1500 ml/min with a maximum water connection pressure of 300 kPa.

These connectors are sealed and need to be drilled open using an 8 mm drill bit before connecting.

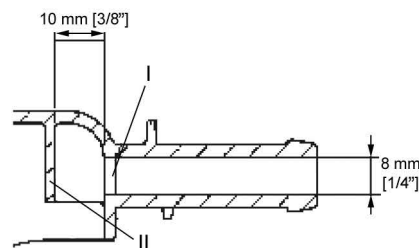

Make sure that you only drill through the first panel (I) as there is a deflecting panel (II) 10 mm behind it.

Connections **3** to **12** are provided for liquid detergent. High-pressure dispensing systems with water injection must not be connected to these connections. The connectors are sealed and must be cut to the diameter of the hose with a small saw before they are connected.

If opened connectors are no longer required, they must be resealed using a suitable sealant (e.g. silicone).

External dispenser pumps are connected and calibrated via the Connector Box, which is available as an option.

Flow meters or flow sensors can also be connected for precise monitoring of the dispensing quantity.

Connections for level monitoring are available for every agent dispensed.

### Drainage

Drain valve DV on machine side DN 70, on-site socket DN 70. Flow rate temporarily 200 l/min.

If the slope for drainage is extremely steep, the piping must be vented to prevent formation of a vacuum in the washing machine's drainage system.

### Electrical connection

The electrical connection must only be carried out by a suitably qualified electrician in accordance with local and national regulations, and the regulations of the responsible power supply company.

**Useful tip:** The connection terminal is located behind the flap on the top rear panel (connecting strip).

If it is necessary to install a residual current device (RCD) in accordance with local regulations, a **residual current device type B** (sensitive to universal current) must be used.

The electrical components of this machine comply with DIN EN 60335-1, DIN EN 50571. The machine must not be connected to devices such as clocks/timers which would switch it off automatically.

See data plate for voltage data.

If the machine has a hard-wired connection, an all-pole means of deactivation must be installed. Switches with a minimum contact gap greater than 3 mm are suitable isolators. These include circuit breakers, fuses and contactors.

Automatic switch-off devices (e.g. clocks/timers) must not be installed.

The plug connector or isolator switch should be easily accessible at all times.

If the machine is disconnected from the mains power supply, the isolator must be lockable or the point of disconnection must be monitored at all times.

## Supervisor level

---

### Opening the Supervisor level

- Switch on the washing machine.

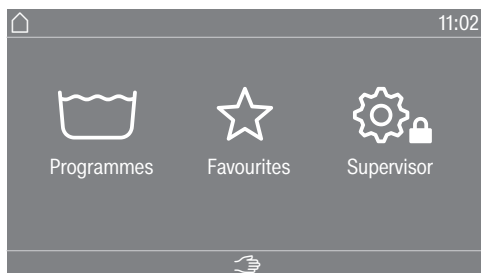

- Touch the Supervisor  sensor.

The display will change to show the Supervisor level menu.

### Opening the supervisor level (self-service)

- Switch on the washing machine and open the door.
- ① Touch the *Start/Stop* sensor and hold it down whilst carrying out steps ②–③.
- ② Close the washing machine door.
- ③ Wait until the *Start/Stop* sensor, which is now flashing rapidly, lights up constantly.
- ④ Release the *Start/Stop* sensor when the *Start/Stop* sensor lights up constantly.

### Code-based access

The Supervisor level is accessed using a code.

The code is **8000** (factory default setting).

After entering the code, you will be in the Supervisor level. The individual setting options are described in the following sections.

### Changing the code

You can change the Supervisor level access code to protect the washing machine from unauthorised access.

Please inform Miele Professional Service if you have forgotten your new code. Miele Professional Service will have to reset the code. Make a note of your new code and store it in a safe place.

### Closing the Settings menu

- Touch the  symbol.

The display will then go back to the previous menu level.

- Touch the  symbol.

The display will change to the main menu.

### Controls / Display

#### Language

The display contents can be displayed in a variety of languages. You can select the permanent supervisor language via the Language sub-menu.

When a programme is running, you can change the user language using the  sensor.

#### Language entry

The display can be set to one of several different user languages. This setting allows you to determine how languages can be selected.

##### International

6 languages are available. The  sensor is not active. Note the setting *Set languages*.

##### Language selection

The  sensor can be used to select a language. All languages are available (factory default setting).

You can change the order of the first 4 languages. These slots are allocated to the most commonly used languages.

##### Default language

The user language cannot be changed. The user language is the same as the supervisor language. The  sensor is not active.

## Supervisor level

---

### Set languages

The languages for the setting Language entry International can be changed.

6 languages can be selected. All languages are available.

If you wish to add a new language to the language menu:

- First select the language you want to replace.

All available languages are displayed.

- Select and confirm the language that is to replace the previous language.

The new language will appear in place of the old one.

### Time

After selecting the clock format, you can set the time of day.

#### Clock format

- 24 h clock
- 12 h clock
- No clock

#### Set

- The time can be set.

### Date

The date can be set after selecting the date format.

#### Date format

- DD.MM.YYYY
- YYYY.MM.DD
- MM.DD.YYYY

#### Date

- The date can be set.

### Logo

Different logos can be selected for the user interface.

### Start screen

Different views can be selected for the start screen. The start screen is displayed after exiting a sub-menu.

### Mode

Different supervisor modes can be selected.

### Display brightness

The brightness of the display can be altered. The setting depends on the various lighting conditions in the place of installation.

It can be set to one of 10 different levels.

### “Display off” status

In order to save energy, the display can be set to switch to standby mode automatically after the end of the programme or if no further selection is made. In the default setting, the machine will not switch to standby mode automatically.

Changing this factory default setting may lead to increased energy consumption.

- Off
- On (10 min.) Not curr.prog.
- Logo (10 min.) Not curr.prog.
- On after 10 min.

	<ul style="list-style-type: none"><li>- On (30 min.) Not curr.prog.</li><li>- Logo (30 min.) Not curr.prog.</li><li>- On after 30 min.</li></ul>
<b>“Machine off” status</b>	<p>In order to save energy, the washing machine can be set to switch to standby mode automatically after the end of the programme or if no further selection is made. In the default setting, the machine will not switch to standby mode automatically.</p> <p>Changing this setting may lead to increased energy consumption.</p> <ul style="list-style-type: none"><li>- No switch-off (factory default setting)</li><li>- Switch-off after 15 minutes</li><li>- Switch-off after 20 minutes</li><li>- Switch-off after 30 minutes</li></ul>
<b>Volume</b>	<p>The volume for various sounds can be changed.</p> <p>It can be set to one of 7 different levels or switched off altogether.</p> <ul style="list-style-type: none"><li>- Finish tone</li><li>- Keypad tone</li><li>- Welcome tone</li><li>- Fault tone</li></ul> <p>The fault tone can be activated or deactivated.</p>
<b>Visibility parameters</b>	<p>Various parameters, such as the temperature, spin speed, Extras etc., are displayed when a programme is selected. You can decide which parameters should not be displayed. The parameters cannot be changed/are no longer displayed.</p> <p>Factory default: all parameters are visible (marked in orange)</p>
Sorting Extras	<p>In the setting Visibility parameters, Sort Extras appears in the bottom line. Touch the sensor to change the sequence of Extras (see “Supervisor level – Moving programmes”).</p>
<b>Delay start</b>	<p>The Delay start (Timer) display can be switched on or off.</p> <p>Factory default setting: On</p>
<b>Memory</b>	<p>The washing machine will save the latest settings (temperature, spin speed and some of the options) which have been selected for a programme after the programme has started.</p> <p>When the programme is selected again, the saved settings will appear in the display.</p> <p>Factory setting: Off</p>
<b>Manual control</b>	<p>The manual control function can be switched on or off. Switch-on can be carried out with or without identification.</p>
<b>Change order</b>	<p>The skip function can be switched on or off.</p>
<b>Measuring system</b>	<p>You can choose whether the temperature and weight are displayed in metric or imperial units.</p>

## Supervisor level

---

### Supervisor code

You can alter the access code to the supervisor level. The supervisor code is independent of the expert code.

- Enter the current code.
- Then enter your new code.

When creating a new code, number sequences such as 1234 and 4-digit numbers such as 2222 are not permitted.

### Wi-Fi

In this menu, you control the networking of your washing machine (see “Networking”).

## Programme selection

### Controls

**Useful tip:** Start by configuring all necessary settings and changes to the washing machine before adjusting any of the options below.

If “Launderette, basic” or “Launderette Logo” is selected, the Supervisor level can no longer be opened from the display after the *Supervisor level* is closed. Please follow the instructions below for special access to the Supervisor level if you wish to change any other settings.

Standard (factory default setting).

All functions and programmes can be displayed.

Launderette, basic

Up to 24 programmes are available. Go to *Favourite programmes* to select which programmes are to be listed.

Launderette logo

Up to 24 programmes are available. Go to *Favourite programmes* to select which programmes are to be listed.

External programme selection

Programmes are selected using a communication module with Ethernet, e.g. via an external terminal.

### Programme packages

The selection of programmes can be expanded by activating single programmes from the target group programme packages.

The programmes selected from the programme packages (marked in orange) are displayed during programme selection.

### Favourite programmes

After switching on, you can also select a programme via:  
☆ Favourites.

24 programmes can be stored as favourite programmes based on your own priorities and requirements.

These favourite programmes will also be made available in the control options

- *Launderette logo*
- *Launderette, basic* control options.

You can specify the control options under *Controls*.

**Useful tip:** You can assign a separate coloured frame to each programme. In this case, the “Colour assign. programme” setting must be set to *On*.

### Changing Favourite programmes

- Select the programme you wish to change or replace.
- Confirm the programme or the setting to be changed.

Another menu opens, enabling you to select a new programme or change the parameters.

- Confirm by touching the *Save* selection area.

Your selection is now active.

### Moving programmes

Programmes can be moved within the programme list and in the Favourites list.

Factory setting: Off

- Touch the selection area for the programme you want to move.
- Press and hold the selection area until the frame changes.
- Drag the programme to the required position.

### Prog. colour allocation

You can assign a frame to a Favourite programme. In the list of favourites, each Favourite programme is given a coloured frame, which can be adjusted.

Factory default setting: on

### Expert code

A code needs to be entered to cancel a disinfection programme. The code can be changed.

The expert code is independent of the supervisor level code.

The code is: 8 0 0 0

Make a note of your new code if you ever change it.

### Process technology

#### Anti-crease

The Anti-crease function helps prevent creasing if laundry is not going to be removed immediately after the end of the programme. The drum continues to turn at intervals for up to 30 minutes at the end of the programme.

The door can be opened at any time during the Anti-crease phase.

Factory default setting: On

#### Automatic drainage

Automatic water drainage can be switched on or off. Automatic water drainage means that the suds are always drained away after the end of a programme. This is also the case for programmes that reach the programme end with water still in the drum.

Factory default setting: off

## Supervisor level

---

### Service

#### Service interval

Service information can appear in the display. You can configure whether a date or the number of operating hours is displayed.

You can select up to 2 messages with your own text.

Your message is displayed at the end of the programme and can be acknowledged with *OK*. The same message appears at the end of the next programme.

#### Settings

This setting allows you to determine the interval (by hours or date) at which the message appears.

- Factory default setting: off
- By time  
You can then select a time interval between 1–9999 hours.
- By date  
You can then select a date.

#### Message text

Enter your individual message text for your planned maintenance work.

#### Reset display

The message will appear until the display is permanently reset. The message then only appears again when the next interval is reached.

### External applications

#### Payment system lock

The payment device lock can be switched on or off. When the lock is switched on, the duration until locking can be selected from various time intervals.

#### Connector box

External hardware is connected via the Connector Box. This can be switched on or off.

The Connector Box must be selected in order for settings to be made in the Dispensing menu.

#### FOC programmes

The free programmes option can be switched on or off.

Off: It is not possible to run programmes free of charge.

On: The programmes configured as free can be run.

#### WRG

The water from the machine is fed into the water recovery system. This option can be switched on or off.

#### Automatic dispensing

Automatic dispensing can be switched on or off.

Automatic dispensing can be activated via the Connector Box or the COM module.

#### Dispensing

The Connector Box must be switched on in order for settings to be adopted in the Dispensing menu.

1–6 dispenser pumps can be switched on.

Further settings can be made after activating the dispenser pump.

- Deactivate disp. pump

- Calibration
- Flow rate (new): ml/min
- Correction factor
- Container size
- Adv. warning level reminder
- Reset adv. warning
- Level reminder
- Flow meter

### Peak load prevention

The peak load prevention function can be switched on or off. With this function, the execution of a wash programme is not affected when a peak load signal is in place. The heater stays switched on.

### Wi-Fi

In this menu, you control the networking of your washing machine (see "Networking").

### Machine parameters

#### Maximum spin speed

The maximum spin speed can be set via a keypad.

#### Max. possible temperature

The maximum temperature can be set via a keypad.

#### Legal information

##### Open source licences

You can view information here (see "Wi-Fi data protection").

### Payment system

The Miele Connector Box accessory unit or the COM module is required to connect a payment device.

- No payment system  
The next settings are skipped.
- Timed operation CB  
The washing machine operates in time mode via the Connector Box.
- COM reserve operation  
The washing machine operates in booking mode based on IP via the COM module.
- Programme control CB  
The washing machine operates in programme mode via the Connector Box.
- COM prog. control  
The washing machine operates in programme mode based on IP via the COM module.

### Settings for the payment system

If you wish to change the settings later, please contact Miele.

# Networking

## Pairing instructions

Follow the steps below to connect the washing machine to your network.

### Network connection

Miele Professional washing machines can be integrated into local networks to utilise Miele's digital solutions or communicate with external systems. The washing machines are equipped with an integrated Wi-Fi module for this purpose. In addition, the washing machines each have an Ethernet connection at the rear for setting up wired interfaces.

⚠ Unauthorised access poses a health risk.

Settings in the washing machine, e.g. parameters for disinfection or the dispensing of process chemicals, may be changed as a result of unauthorised access via the network. Under no circumstances should it be possible to access the washing machine via the Internet or other public or unsecured networks, either directly or indirectly (e.g. using port forwarding).

1. The washing machine should be operated only in a separate network segment which meets one of the following requirements:
  - It is physically separated from other network segments.
  - Access to the segment is restricted by a firewall or a router which has been configured accordingly.
2. Limit access to this separate network segment to persons requiring access in the course of their work.
3. Use strong passwords to protect access to systems that are connected to the washing machine.
4. Configure the Ethernet interface.

### Opening the Supervisor level

- Select the Supervisor menu option in the machine display.
- Select the Access via code menu option.
- Enter the 4-digit supervisor code.

### Initial network setup

- Select the Supervisor level menu option from the External applications menu.
- Select Wi-Fi / LAN.

The options in the Wi-Fi / LAN menu vary depending on whether the Wi-Fi interface is already set up or needs to be set up.

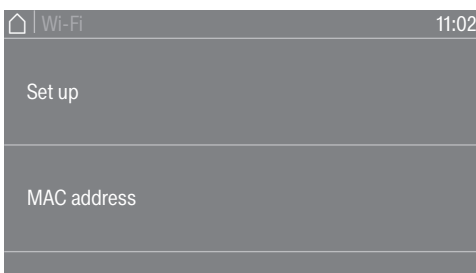

- Select Set up to connect the machine to a network.

The message Set up only appears if the washing machine has not yet been connected to a Wi-Fi network. Various options are available for setting up the Wi-Fi interface.

- Select MAC address to read out the MAC addresses of the network adapters.

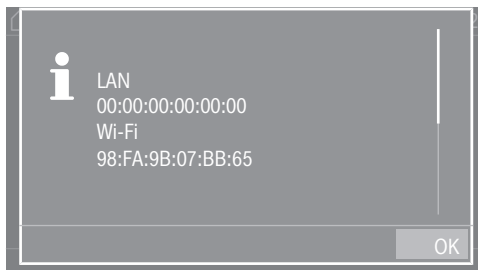

The MAC address of the network adapters is displayed. No settings can be made.

## Setting up a network connection manually

- Select the Supervisor level menu option from the External applications menu.
- Then select the Wi-Fi / LAN menu option.
- Select Set up.
- Select the Manual connection method.

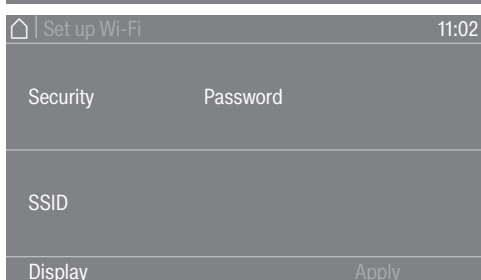
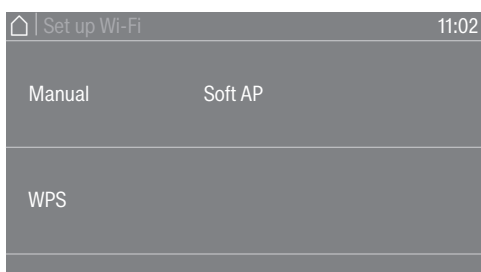

- Select Security to set the security standard for the wireless connection.
- Select Password to enter the Wi-Fi password.
- Select SSID to enter the network name (SSID).

You can view all settings for Security, Password and SSID under Display.

- Save all settings with Apply.

# Networking

---

## Establishing the network connection via WPS

- Select the Supervisor level menu option from the External applications menu.
- Then select the Wi-Fi / LAN menu option.
- Select Set up.
- Select the Via WPS connection method.
- Now press the WPS button on your router and confirm with OK in the machine display.

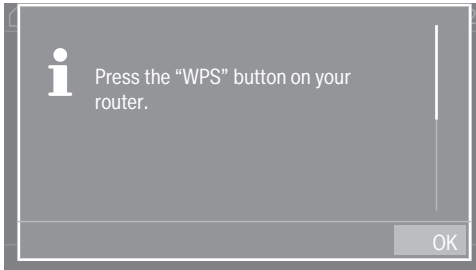

A timer starts. The network connection via WPS is being established.

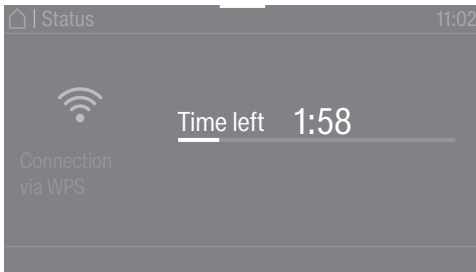

The machine is now successfully connected.

- Touch OK to confirm.

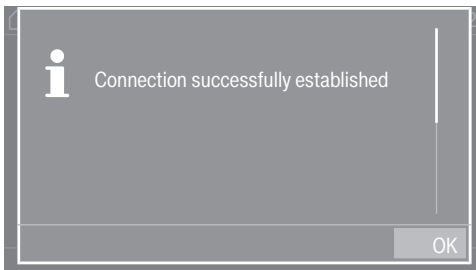

### Establishing the network connection via soft AP

- Select the Supervisor level menu option from the External applications menu.
- Then select the Wi-Fi / LAN menu option.
- Select Set up.
- Select the Via Soft AP connection method.
- Confirm by pressing OK and follow the instructions in the external application.

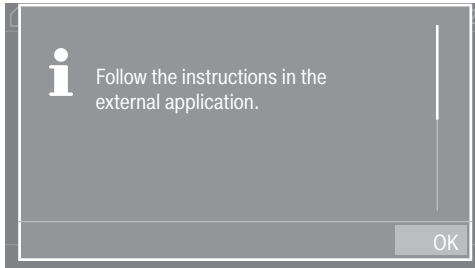

The display shows the message *Waiting for connection* for approx. 10 minutes. If the connection is successful, a message is then displayed. If the connection has failed, the message *Connection failed* is displayed.

- If the connection fails, confirm with OK and start a new connection attempt.

### Establishing the network connection using a LAN cable

- Connect the machine to your router/switch using the network cable.

The machine is now successfully connected.

# Networking

---

## Wi-Fi/LAN interface configured

Once the network connection has been successfully set up, you can select further options in the menu.

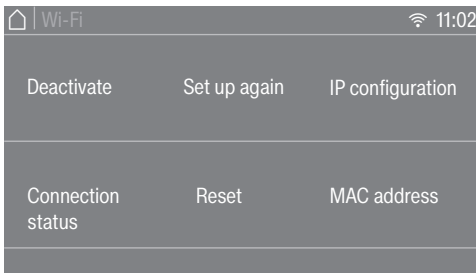

- The Wi-Fi function is switched off with **Deactivate** (visible when the network is activated). The network remains set up.
- The Wi-Fi function is reactivated with **Activate** (visible when the network is deactivated).
- All network parameters are displayed under **Connection status**.
- You can set up the Wi-Fi interface again under **Set up again**.
- Use **Reset** to disconnect the network setup. The Wi-Fi function is deactivated and the Wi-Fi connection will be reset to the factory default settings. A new connection has to be established in order to use the network again.
- You can configure the IP settings manually under **IP configuration**. The interface can be set up via a Dynamic Host Configuration Protocol (DHCP). If you deactivate the DHCP setting, you can configure the interface using the following parameters:
  - IP address
  - Subnet mask
  - Gateway
  - DNS Auto
  - DNS server 1
  - DNS server 2
- The address of the network adapters is displayed under **MAC address**.

## Technical data

### System requirements for Wi-Fi

- Wi-Fi 802.11b/g/n
- 2.4 GHz band
- WPA/WPA2 encryption
- DHCP activated
- Multicast DNS / Bonjour / IGMP snooping activated
- Ports 443, 80, 53, and 5353 open
- IP DNS server = IP standard gateway/router
- Mesh/Repeater use: same SSID and password as standard gateway/router
- SSID must be permanently visible



### System requirements for LAN

- DHCP activated
- Multicast DNS / Bonjour / IGMP snooping activated
- Ports 443, 80, 53, and 5353 open
- IP DNS server = IP standard gateway/router

## Wi-Fi signal strength – Guide values

The Wi-Fi signal strength is only a rough guide. These details do not provide absolute certainty.

The Wi-Fi signal strength can be read directly on the machine.

Wi-Fi signal strength		Meaning
	 *	
76–100%	3/3**	Generally, reliable operation possible
51–75%	2/3	
26–50%	1/3	Generally, operation possible
1–25%	0/3	Generally, reliable operation not possible
0 %		Operation not possible

\* Displayed on the machine

\*\* Number of bars  3/3–0/3

The signal strength can be adversely affected by many factors:

- People in the room
- Open or closed doors
- Moved objects
- Varying radio signal sources or interference
- Other machines with Bluetooth or Wi-Fi wireless technology

# Technical data

---

## PWM 927 machine data

### Installation dimensions

Casing width (without add-on components)	1090 mm
Casing height (without add-on components)	1643 mm
Casing depth (without add-on components)	1106mm
Overall machine width	1090 mm
Overall machine height	1646 mm
Overall machine depth	1228 mm
Minimum width of transport opening	1190mm
Minimum distance between wall and machine front	1800 mm
Diameter of door opening	415mm
Door opening angle	180°

### Electrical connection

Supply voltage	see data plate
Frequency	see data plate
Total rated load	see data plate
Current draw	see data plate
Fuse rating	see data plate
Heater rating	see data plate

### Weight and floor load

Net weight	see installation plan
Maximum floor load during operation	see installation plan

### Emission values

Emission sound pressure level in workplace in accordance with EN ISO 11204/11203	< 70 dB(A) re 20 µPa
Sound power level, EN ISO 9614-2	< 83.6 dB(A)

### Product safety

Product safety standard	EN 60335-1, EN 50571, AS/NZS 60335-1, AS/NZS 60335-2-7
-------------------------	--

### Wi-Fi

Frequency band of the Wi-Fi module	2.400–2.4835 GHz
Maximum transmission power of the Wi-Fi module	< 100 mW

## PWM 935 machine data

### Installation dimensions

Casing width (without add-on components)	1090 mm
Casing height (without add-on components)	1643 mm
Casing depth (without add-on components)	1106 mm
Overall machine width	1090 mm
Overall machine height	1646 mm
Overall machine depth	1275 mm
Minimum width of transport opening	1190 mm
Minimum distance between wall and machine front	1800 mm
Diameter of door opening	415 mm
Door opening angle	180°

### Electrical connection

Supply voltage	see data plate
Frequency	see data plate
Total rated load	see data plate
Current draw	see data plate
Fuse rating	see data plate
Heater rating	see data plate

### Weight and floor load

Net weight	see installation plan
Maximum floor load during operation	see installation plan

### Emission values

Emission sound pressure level in workplace in accordance with EN ISO 11204/11203	< 70 dB(A) re 20 µPa
Sound power level, EN ISO 9614-2	< 83.6 dB(A)

### Product safety

Product safety standard	EN 60335-1, EN 50571, AS/NZS 60335-1, AS/NZS 60335-2-7
-------------------------	--

### Wi-Fi

Frequency band of the Wi-Fi module	2.400–2.4835 GHz
Maximum transmission power of the Wi-Fi module	< 100 mW

### **Data protection and data security**

When you activate the networking function and connect your machine to the Internet, your machine sends the following data to the Miele Cloud:

- Machine serial number
- Machine model and technical features
- Machine status
- Information about the software status of your machine

Initially, this data cannot be assigned to a specific user and is not saved permanently. Data cannot be saved permanently or assigned to a specific user until after you have linked your machine to a user. Data transmission and processing are governed by Miele's strict security standards.

### **Factory default settings for network configuration**

You can reset all of the settings on the communication module or your integrated Wi-Fi module to the factory default settings. The network configuration should be reset whenever a machine is being disposed of or sold, or if a used machine is being put into operation. This is the only way to ensure that all personal data has been removed and, in the case of the latter, the previous owner will no longer be able to access the machine.

### **Copyright and licences**

For the purpose of operating and controlling the communication module, Miele uses proprietary or third-party software that is not covered by open source licensing terms. These items of software/software components are protected by copyright. The copyright powers of Miele and third parties must be respected.

Furthermore, this communication module contains software components which are distributed under open source licence conditions. The open source components contained in the machine along with the corresponding copyright notices, copies of the licensing terms valid at the time and any further information can be accessed locally by IP using a web browser (*https://<IP address>/Licenses*). The liability and warranty arrangements for the open source licences displayed in this location only apply in relation to the respective rights holders.



**Miele Australia Pty. Ltd.**

ACN 005 635 398

ABN 96 005 635 398

Melbourne:

Level 4, 141 Camberwell Road

Hawthorn East, VIC 3123

Telephone: 1300 731 411

[professional.service@miele.com.au](mailto:professional.service@miele.com.au)

[www.miele-professional.com.au](http://www.miele-professional.com.au)

[professional.sales@miele.com.au](mailto:professional.sales@miele.com.au)

**Miele New Zealand Limited**

IRD 98 463 631

8 College Hill

Freemans Bay

Auckland 1011

New Zealand

Telephone: 0800 4 MIELE

(0800 464 353)

[www.miele-professional.com.au](http://www.miele-professional.com.au)

[professional.sales@miele.com.au](mailto:professional.sales@miele.com.au)



Miele Global Headquarters: Miele & Cie. KG  
Carl-Miele-Straße 29, 33332 Gütersloh, Germany