



Operating instructions for washing machines



To avoid the risk of accidents or damage to the machine, it is **essential** to read these instructions before it is installed and used for the first time.





Contents

Caring for the environment	6
Warning and Safety instructions	7
Operating the washing machine	14
Control panel	14
Display	16
Examples on how to operate the machine	16
Before using for the first time	17
Miele@home	18
1. Set the language	19
2. Setting up Miele@home	19
3. Remove the transit bars	20
4. Commissioning TwinDos	20
5. Starting the calibration programme	23
Washing environmentally and economically	24
Hygiene in the washing machine	24
 Feedback	25
1. Prepare the laundry	26
2. Select a programme	27
3. Load the washing machine	29
4. Select programme settings	30
Selecting a temperature/spin speed	30
Selecting an extra option	30
 Level of soiling	30
 Delay start/SmartStart	31
5. Add detergent	33
Detergent dispenser drawer	35
CapDosing	37
6. Starting the programme	39
Adding laundry during a programme sequence (AddLoad)	39
7. End of programme	40
Spinning	41

Programme chart	43
Garment care label symbols	50
Extra options	51
SingleWash.....	51
Water +	51
Extra options can be selected using the Extras sensor control	52
Quick	52
Stains.....	52
Pre-wash	52
Soak	52
Intensive	52
Extra quiet	53
Extra gentle	53
AllergoWash	53
Wash programme chart - Extras	54
Programme sequence	56
Changing the programme sequence	59
Changing a programme (safety lock)	59
Interrupting a programme.....	59
Cancelling a programme	59
Detergent	60
The correct detergent.....	60
Water softeners	60
Dispensing aids	60
Fabric conditioner and liquid starch.....	60
Recommended Miele detergents	62
Recommended detergents in accordance with Directive (EU) Nr. 1015/2010....	63
Replacing the TwinDos cartridge	64
Cleaning and care	65
Cleaning the external casing and the control panel	65
Cleaning the detergent dispenser drawer	65
TwinDos maintenance	67
Hygiene info(Cleaning the drum)	68
Cleaning the water inlet filter	68

Contents

Problem solving guide	69
The programme does not start.....	69
Fault message after a programme has been interrupted.	70
Fault message at the end of a programme	71
Messages or faults with the TwinDos system	73
General problems with the washing machine	75
An unsatisfactory wash result	77
The door will not open.....	78
Opening the door in the event of a blocked drain outlet and/or power cut	79
Service	81
Contact in the event of a fault	81
Optional accessories.....	81
Guarantee.....	81
Installation	82
Front view	82
Rear view.....	83
Installation surface	84
Transporting the washing machine to its installation site.....	84
Removing the transit bars	85
Fitting the transit bars	87
Levelling the machine.....	88
Screwing out and adjusting the feet.....	88
Installing under a continuous worktop	89
Washer-dryer stack	89
The water protection system.....	90
Connection to the water supply	90
Connecting the water inlet	90
Water drainage	92
Fitting the elbow.....	92
Direct connection to a sink drain outlet.....	93
Electrical connection	94
Consumption data	95
Note for test institutes	95
Technical data	96

Settings	97
Accessing the Settings menu.....	97
Selecting settings.....	97
Changing a setting	97
Closing the settings menu.....	97
Language 	98
TwinDos.....	98
Degree of soiling.....	99
Buzzer volume.....	99
Keypad tone.....	99
Welcome tone	99
Consumption.....	99
Code.....	100
Units	100
Brightness	100
Disp. switch-off stat.	101
Programme info.....	101
Memory	101
Long p-wash Cotton	101
Soak duration	102
Gentle action	102
Temp. reduction.....	102
Water plus	102
Water plus level.....	102
Maximum rinse level.....	103
Suds cooling.....	103
Low water pressure	103
Anti-crease	103
Miele@home	104
Remote control.....	105
SmartGrid.....	105
RemoteUpdate	106
Copyrights and licences for the communication module.....	107
 Detergents and care products	 108
Detergent.....	108
Specialist detergents 	109
Fabric care 	110
Additives 	110
Machine care.....	110

Caring for the environment

Disposing of the packaging material

The packaging material is used for handling and protects the appliance from transport damage. The packaging material used is selected from materials which are environmentally friendly for disposal and can generally be recycled.

Recycling the packaging material reduces the use of raw materials. Use material-specific collection points for valuable materials and take advantage of return options. Your Miele dealer will take the packaging material away.

Disposing of your old appliance

Electrical and electronic appliances often contain valuable materials. They also contain specific materials, compounds and components, which were essential for their correct function and safety. These could be hazardous to human health and to the environment if disposed of with your domestic waste or if handled incorrectly. Please do not, therefore, dispose of your old appliance with your household waste.



Please dispose of it at your local community waste collection / recycling centre for electrical and electronic appliances, or contact your dealer or Miele for advice. You are also responsible (by law, depending on territory) for deleting any personal data that may be stored on the appliance being disposed of. Please ensure that your old appliance poses no risk to children while being stored prior to disposal.

Warning and Safety instructions

This washing machine complies with all current local and national safety requirements. However, inappropriate use can lead to personal injury and damage to property.

Read the operating instructions carefully before using the washing machine. They contain important information on safety, installation, use and maintenance. This prevents both personal injury and damage to the washing machine.

In accordance with standard IEC 60335-1, Miele expressly and strongly advises that you read and follow the instructions in the chapter on installing the washing machine as well as the safety instructions and warnings.

Miele cannot be held liable for damage caused by non-compliance with these instructions.

Keep these operating instructions in a safe place and pass them on to any future owner.

Correct application

- ▶ This washing machine is intended for use in domestic households and similar working and residential environments.
- ▶ The washing machine is not intended for outdoor use.
- ▶ It must be used only as a domestic appliance to wash items which are specified by the manufacturer as being washable on the wash care label. Miele cannot be held liable for damage resulting from incorrect or improper use or operation.
- ▶ The washing machine can only be used by people with reduced physical, sensory or mental capabilities, or lack of experience or knowledge, if they are supervised whilst using it or have been shown how to use it safely and recognise and understand the consequences of incorrect operation.

Warning and Safety instructions

Safety with children

- ▶ Children under 8 years of age must be kept away from the washing machine unless they are constantly supervised.
- ▶ Children 8 years and older may only use the washing machine unsupervised if they have been shown how to use it safely and recognise and understand the consequences of incorrect operation.
- ▶ Children must not be allowed to clean or maintain the washing machine unsupervised.
- ▶ Please supervise children in the vicinity of the washing machine and do not let them play with it.

Technical safety

- ▶ Please observe the instructions in “Installation” and “Technical data”.
- ▶ Before setting up the washing machine, check it for any externally visible damage. Do not install or use a damaged machine.
- ▶ Before connecting the washing machine, ensure that the connection data on the data plate (fuse rating, voltage and frequency) match the mains electricity supply. If in any doubt, consult a qualified electrician.

Warning and Safety instructions

► Temporary or permanent operation on an autonomous power supply system or a power supply system that is not synchronised with the mains power supply (e.g. island networks, back-up systems) is possible. A prerequisite for operation is that the power supply system complies with the specifications of EN 50160 or an equivalent standard.

The function and operation of the protective measures provided in the domestic electrical installation and in this Miele product must also be maintained in isolated operation or in operation that is not synchronised with the mains power supply, or these measures must be replaced by equivalent measures in the installation. As described, for example, in the current version of BS OHSAS 18001–2 ISO 45001.

► The electrical safety of this washing machine can only be guaranteed when correctly earthed.

It is essential that this standard safety requirement is met. If in any doubt, please have the wiring system of the building tested by a qualified electrician.

Miele cannot be held liable for the consequences of an inadequate earthing system (e.g. electric shock).

► Do not connect the washing machine to the mains electricity supply by a multi-socket adapter, extension lead or similar. These do not guarantee the required safety of the machine (fire hazard due to the risk of overheating).

► Faulty components must only be replaced by genuine Miele original spare parts. Only when these parts are fitted can Miele guarantee the safety standards of the machine.

► The electrical socket must be easily accessible after installation so that the machine can be disconnected from the electricity supply if necessary.

Warning and Safety instructions

- ▶ Unauthorised repairs could result in unforeseen dangers for the user, for which the manufacturer cannot accept liability. Repairs should only be undertaken by a Miele authorised service technician, otherwise any subsequent damage will not be covered by the warranty.
- ▶ While the washing machine is under warranty, repairs should only be undertaken by a Miele authorised service technician. Otherwise the warranty will be invalidated.
- ▶ If the electrical connection cable is faulty it must only be replaced by a Miele authorised service technician to protect the user from danger.
- ▶ The machine must be isolated from the electricity supply when cleaning and maintaining the machine and in the event of a fault.
- ▶ The machine must only be connected to the on-site water supply using a new hose kit. Old hose kits must not be re-used. Check the condition of the hoses regularly so that you can replace them in good time and avoid the risk of any water damage.
- ▶ The water flow pressure must be at least 100 kPa and should not exceed 1000 kPa.
- ▶ In areas which may be subject to infestation by cockroaches or other vermin, pay particular attention to keeping the machine and its surroundings in a clean condition at all times. Any damage which may be caused by cockroaches or other vermin will not be covered by the warranty.
- ▶ The machine must not be used in a non-stationary location (e.g. on a ship).
- ▶ Do not make any alterations to the machine, unless authorised to do so by Miele.

Correct use

▶ Do not install the washing machine in a room where there is a risk of frost. Frozen hoses may burst or split. The reliability of the electronic control unit may be impaired at temperatures below freezing point.

▶ Before using the machine for the first time, check that the transit bars at the rear of the machine have been removed (see “Installation - Removing the transit bars”). During spinning, a transit bar which is still in place may result in damage to both the machine and adjacent furniture or appliances.

▶ Turn off the stopcock if the machine is to be left for any length of time (e.g. holiday), especially if there is no floor drain (gully) in the immediate vicinity.

▶ Flooding danger.

If hooking the drain hose into a wash basin, check that the water can drain off quickly enough to prevent the sink from overflowing. Make sure the drain hose is secure, so that the force of the water flowing out of the hose does not dislodge it.

▶ Take care to ensure that foreign objects (e.g. nails, pins, coins, paper clips) do not find their way into the machine with the laundry. These may damage components of the machine (e.g. suds container, drum), which in turn can result in damage to the laundry.

▶ Take care when opening the drum door after using the steam function. Danger of burning due to escaping steam and the high temperature of the surface of the drum as well as the porthole glass. Stand back away from the machine and wait until the steam has dissipated.

▶ The maximum load for this washing machine is 9.0 kg (dry weight). See the “Programme chart” for the maximum recommended loads for individual programmes.

Warning and Safety instructions

- ▶ If the correct amount of detergent is dispensed, the machine should not need to be descaled. If, however, you do wish to descale it, only use a proprietary natural citric acid based descaling agent. Miele recommends using Miele descaling agent which is available to order from your Miele dealer. Strictly observe the instructions on the packaging.
- ▶ Textiles which have been pre-treated in solvent based cleaning agents must be thoroughly rinsed in clean water before being washed in the machine.
- ▶ Do not use solvent based cleaning agents, e.g. those containing benzene, in this machine, as this may result in damage to component parts and create toxic fumes. Such agents also pose a fire and explosion hazard.
- ▶ Do not use solvent based cleaning agents, e.g. those containing benzene, to clean the surfaces of the machine. They can cause damage to plastic surfaces.
- ▶ Only use dyes specified by the manufacturer as being suitable for use in a domestic washing machine. Always observe the manufacturer's instructions carefully.
- ▶ Colour run and dye removers contain sulphur compounds which can cause damage such as corrosion. Do not use these products in this machine.
- ▶ If detergent comes into contact with the eyes, rinse them thoroughly with lukewarm water immediately. If swallowed, seek medical assistance immediately and retain the packaging or label for reference. Those with skin problems or sensitive skin should avoid their skin coming into contact with detergent.

Accessories and spare parts

- ▶ Only use original Miele accessories and spare parts. If other parts are used, warranty, performance and product liability claims will be invalidated.
- ▶ A Miele tumble dryer can be stacked on top of a Miele washing machine using the appropriate stacking kit (available as an optional accessory). Please make sure you order the correct one for the Miele washing machine and Miele tumble dryer.
- ▶ If installing the machine on a Miele plinth, (available as an optional accessory, depending on country), please make sure you order the correct one for this washing machine.
- ▶ Miele will guarantee to supply functional spare parts for a minimum of 10 years and up to 15 years following the discontinuation of your washing machine.

Miele cannot be held liable for damage caused by non-compliance with these Warning and Safety instructions.

Operating the washing machine

Control panel

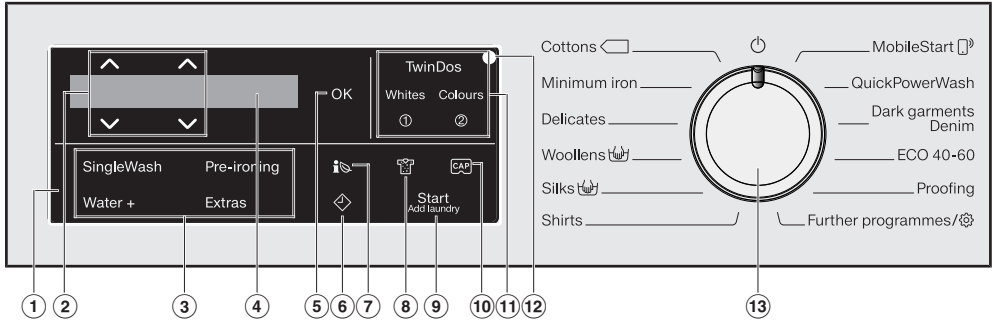

① Control field

The control field consists of a display and various sensor controls. The individual sensors are explained in the following sections.

② ^ v sensors

Values shown in the display can be changed with the ^ v sensors. The ^ sensor increases the value or moves up the list; the v sensor decreases the value or moves down the list.

③ Sensors for extra options

You can supplement wash programmes with extra options. If a wash programme has been selected, the sensor controls for the possible Extras light up dimly.

④ Display

The following values are shown on the display and/or selected from it:

1. The temperature, spin speed, and time left for the selected wash programme.
2. The individual values for selected extras and settings.

⑤ OK sensor control

The OK sensor control is used for confirming selected values.

⑥ ◆ sensor

The ◆ sensor starts the delay start function. With Delay start you can delay the start of the programme. The start of the programme can be delayed from 15 minutes up to a maximum of 24 hours. This allows you to make use of night-time economy electricity rates, for example. Please see “Delay start” for more information.

⑦ **sensor control**

You can view information about the energy and water consumption of your washing machine with the  sensor.

See “Washing environmentally and economically, Feedback” for more information.

The following information will appear in the display:

- An estimate of the energy and water consumption before the programme begins.
- The actual energy and water consumption and the cost during the programme or at the end of the programme.

⑧ **sensor**

You can specify the level of soiling of the load in three settings. This sensor is only active with the *TwinDos* option activated.

⑨ **Start/Add laundry sensor control**

- ① The programme can be started as soon as the sensor control is flashing on and off. Touching the *Start/Add laundry* sensor control starts the selected programme. The sensor control lights up constantly.
- ② Once the programme has been started, the *Start/Add laundry* sensor control allows you to add laundry.

⑩ **sensor**

This sensor is used for activating Cap dispensing.

⑪ **TwinDos sensor control with the additional Whites and Colours sensor controls**

The *TwinDos* sensor control is used for deactivating and activating automatic detergent dispensing. Depending on the colour mix of your load, you can control the detergent combination by selecting the *Whites* or *Colours* sensor control. Further information can be found in “*TwinDos*”.

⑫ **Optical interface**

This is used by the Service department as a transmission point.

⑬ **Programme selector**

for selecting programmes and for switching off the appliance. The washing machine is switched on when you select a programme, and switched off by turning the programme selector to the  position.

Operating the washing machine

Display

The standard display shows the following from left to right:



- The selected wash temperature
- The selected spin speed
- Programme duration

Examples on how to operate the machine

Scrolling through a list

The  scroll bar in the display indicates that a list of choices is available.



Scroll down the list with the ∇ sensor control. Scroll up the list with the \blacktriangle sensor control. The *OK* sensor control is used to activate the option shown in the display.

Identifying the selected option



An activated option in a list will have a tick \checkmark next to it.

Setting numerical values



The numerical value is highlighted in white. Touching the ∇ sensor control decreases the value. Touching the \blacktriangle sensor control increases the value. The *OK* sensor control is used to activate the value shown in the display.

Exiting a sub-menu

Select Back  to exit a sub-menu.

Before using for the first time

 Damage resulting from incorrect installation and connection.

Installing and connecting the washing machine incorrectly will cause serious property damage. See “Installation”.

Removing the protective foil and stickers

■ Remove:

- Any protective film from the door
- Any stickers from the front and the lid

Please do not remove any labels (e.g. the data plate) which are visible when you open the door.

This washing machine has undergone a complete functional test at the factory and there will be some residual water in the drum from this process.

Remove the detergent cartridges and the drain hose elbow from the drum

Two detergent cartridges for automatic detergent dispensing and an elbow piece for the drain hose are stored in the drum.

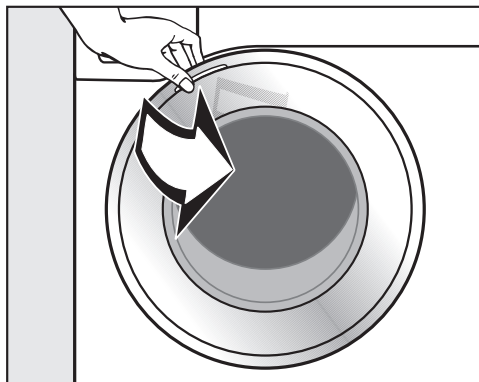

- Pull open the door.
- Take the two cartridges and the elbow piece out of the drum.

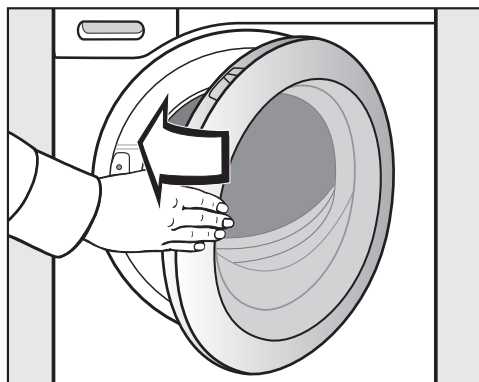

- Shut the door with a gentle swing.

Before using for the first time

Miele@home

Your washing machine is equipped with an integrated WiFi module.

In order to use it you need:

- a WiFi network
- the Miele@mobile App
- a Miele user account. The user account can be created via the Miele@mobile App.

The Miele@mobile App will guide you as you connect your washing machine to your home WiFi network.

Once your washing machine is connected to your WiFi network you can use the App, for example, to carry the following activities:

- Operate your washing machine remotely
- Access information about the operating status of your washing machine
- Access information about a programme sequence on your washing machine

Connecting your washing machine to your WiFi network will increase energy consumption, even when the washing machine is switched off.

Before installing the washing machine in its final location, ensure the signal strength is sufficient for your WiFi network.

Availability of the WiFi connection

The WiFi connection shares a frequency range with other appliances (including microwave ovens and remote control toys). This can give rise to sporadic or even complete connection failures. Therefore, the availability of featured functions cannot be guaranteed.

Miele@home availability

The ability to use the Miele app depends on the availability of the Miele@home service in your country.

The Miele@home service is not available in every country.

For information about availability, please visit www.miele.com.

Miele App

The Miele App is available to download free of charge from the Apple App Store[®] or from the Google Play Store[™].



Switching on the washing machine

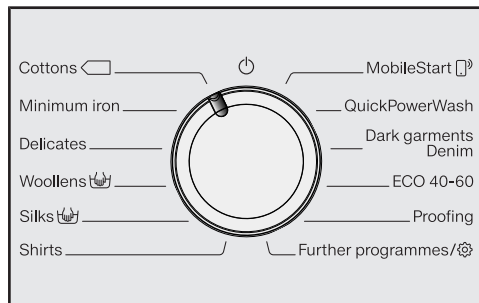

- Turn the programme selector to the *Cottons* programme.

The welcome tone will sound and the welcome screen will light up.

The display will guide you through the **5 steps** of the initial commissioning process.

1. Set the language

You will be prompted to set the display language. It is possible to change the language at any time by setting the programme selector to *Further programmes* in the *Settings* sub-menu.



- Touch the ∇/Δ sensor controls until the language you want appears in the display.
- Confirm your choice of language by touching the *OK* sensor control.

2. Setting up Miele@home

The following message appears in the display:

i Miele@home

- Confirm with *OK*.

The following message appears in the display:

Set up now

- To set up Miele@home now: touch the *OK* sensor control.

- To postpone setup until later: touch the ∇ sensor control until the following appears in the display: Set up later and press *OK* to confirm.

The following selection options appear in the display:

1. Connect via WPS
2. Connect via App

- Select the required connection type.

You will then be guided by the display and the Miele app.

Before using for the first time

3. Remove the transit bars

 Damage resulting from failure to remove the transit bars. Failure to remove the transit bars can result in damage to the washing machine and to adjacent cabinetry or appliances. Remove the transit bars as described in “Installation and connection”.

The following message appears in the display:

-  Remove transit bars
- Confirm with the *OK* sensor control.

4. Commissioning TwinDos

The UltraPhase 1 and UltraPhase 2 values are preset in the standard settings and only need to be confirmed.

The following message appears in the display:

-  TwinDos
- Confirm with the *OK* sensor control.

The following message appears in the display:

- Set now
- To set up TwinDos now, touch the *OK* sensor control.
 - To postpone setup until later: touch the ∇ sensor control until the following appears in the display: Set later and press *OK* to confirm.

Settings for compartment ①

The UltraPhase 1 values are preset in the standard settings.



- Confirm with the *OK* sensor control.

The following appears in the display:



-  Set the dosage. Observe water hardness levels

- Confirm with the *OK* sensor control.

The dispensing quantity for UltraPhase 1 is preset for  (hardness level I).



- Confirm the preset value with the *OK* sensor control. If you want to change this value, use the ∇/\wedge sensor controls and confirm with the *OK* sensor control.

UltraPhase 1		
	Hardness level I	46 ml
	Hardness level II	58 ml
	Hardness level III	70 ml

Before using for the first time

The following appears in the display:

i Insert ①

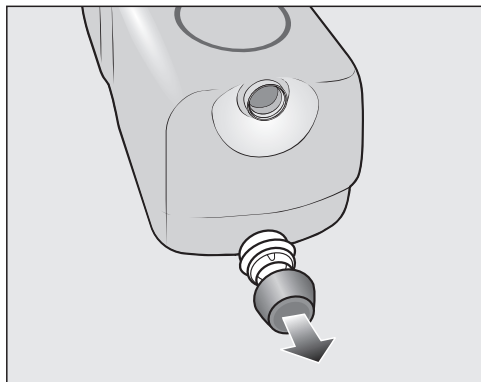

- Remove the cover cap from the **UltraPhase 1** detergent cartridge included with the delivery.

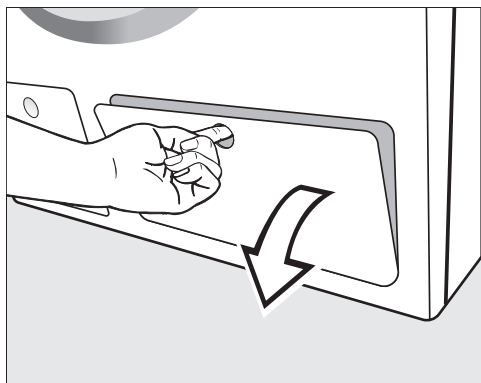

- Open the access panel for TwinDos.

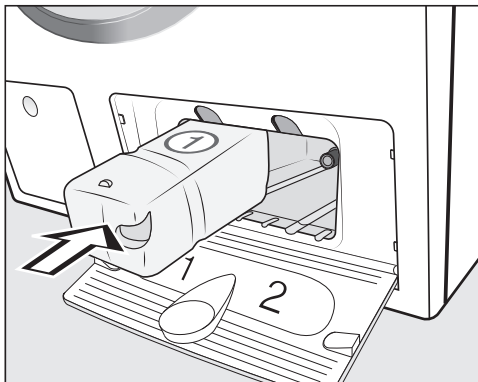

- Push the **UltraPhase 1** detergent cartridge into **compartment 1** until it locks into position.

Before using for the first time

Settings for compartment ②

The UltraPhase 2 values are preset in the standard settings.

After the cartridge has been pushed in, the display message switches to:



- Confirm with the *OK* sensor control.



- Confirm with the *OK* sensor control.

The dispensing quantity for UltraPhase 2 is preset for (hardness level I).



- Confirm the preset value with the *OK* sensor control. If you want to change this value, use the ∇/\wedge sensor controls and confirm with the *OK* sensor control.

UltraPhase 2		
	Hardness level I	36 ml
	Hardness level II	45 ml
	Hardness level III	54 ml

The following appears in the display:

- **i** Insert ②

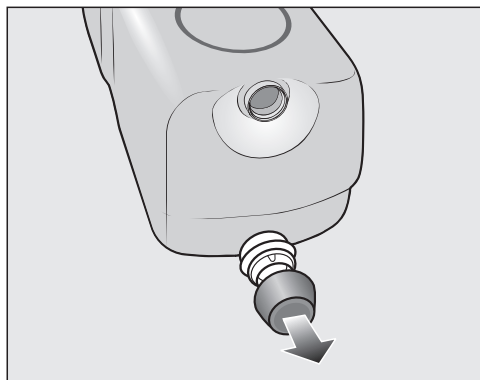

- Remove the cover cap from the **UltraPhase 2** detergent cartridge included with the delivery.

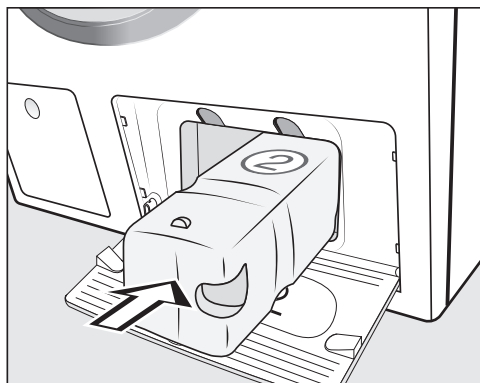

- Push the **UltraPhase 2** detergent cartridge into **compartment 2** until it locks into position.

When the cartridge is pushed in, the message in the display changes to:

- **i** "TwinDos" is set. Can be changed in "Settings".

- Confirm with the *OK* sensor control.
- Close the TwinDos access panel.

5. Starting the calibration programme

For optimum water and energy consumption and excellent wash results, it is important to calibrate the washing machine.

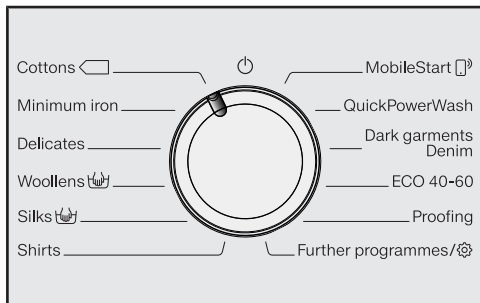

To do this, the *Cottons* programme **must** be run without laundry and without detergent.

No other programmes can be started until calibration has been carried out.

The following message appears in the display:

Open  and run "Cottons 90°C" without laundry.

- Touch the  sensor control until the *OK* sensor control lights up and confirm with *OK*.



- Open the stopcock.
- Touch the *Start/Add laundry* sensor control.

The calibration programme then starts. It will take approximately 2 hours.

At the end of the programme, the following message will appear in the display:

-  Set up complete

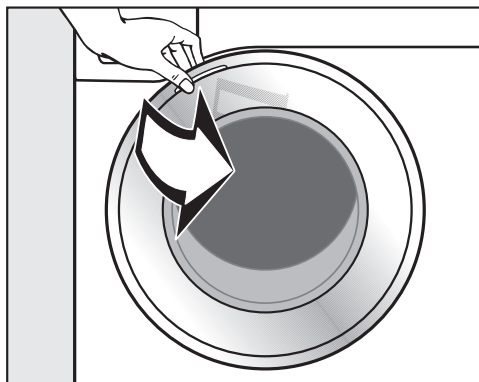

- Take hold of the door and pull it open.

Tip: Leave the door slightly open to allow the drum to dry.

- Turn the programme selector to the  position.

Washing environmentally and economically

Energy and water consumption

- To get the most out of your machine, load the maximum dry load size for the wash programme you are using. This will keep the energy and water consumption to a minimum in relation to the size of the load.
- Programmes that are more efficient with regard to energy and water consumption generally have a longer running time. By extending the programme running time, the wash temperature that is actually reached can be reduced while still providing the same wash results.

For example, the ECO 40-60 programme has a longer running time than the Cottons 40 °C or 60 °C programme. The ECO 40-60 programme is more efficient in terms of energy and water consumption but has a longer running time.

- Use the Express 20 programme for small, lightly soiled loads.
- Modern detergents make it possible to wash at lower temperatures (e.g. 20 °C). Using lower temperature settings will save energy.

Hygiene in the washing machine

Washing at low temperatures and/or using liquid detergents can cause bacteria and odours to build up in the washing machine. Miele therefore recommends cleaning the washing machine once every month.

When the message Hygiene info: run a programme at min. 75 °C or the "Clean machine" programme appears in the display, the washing machine must be cleaned.

Information about subsequent tumble drying

The spin speed selected affects the residual moisture in the laundry and the sound emissions of the washing machine.

The higher the spin speed, the lower the residual moisture in the laundry. However, the sound emissions of the washing machine will increase.

Select the highest possible spin speed for the wash programme to save energy in the subsequent tumble dryer cycle.

Detergent

- For precise dispensing use automatic detergent dispensing.
- Adjust the dosage to the degree of soiling of the laundry.
- Do not exceed the amounts of detergent recommended by the manufacturer on the packaging.

Washing environmentally and economically

Feedback

You can view information about the energy and water consumption of your washing machine with the  sensor.

The following information will appear in the display:

- An estimate of the energy and water consumption before the programme begins.
- The actual energy and water consumption and the cost during the programme or at the end of the programme.

1. Estimate

- After selecting a programme, touch the  sensor.

The estimated energy and water consumption levels will be displayed as a bar chart.



The more bars visible (|), the higher the energy or water consumption.

The estimate will vary depending on the wash programme, temperature and any options selected.

- Touch the **OK** sensor or wait until the display automatically returns to the standard display.

2. Actual consumption

You can view the actual amount of energy and water used by a programme both during and at the end of the programme.

- Touch the  sensor.



- Use the ∇/Δ sensors to change to the estimated water consumption levels.

The consumption will alter as the programme progresses.

If the door is opened or the machine has switched off automatically at the end of the programme, the data will revert to the estimated consumption.

Tip: You can view the consumption data for the last wash programme in Settings  under Consumption.

1. Prepare the laundry

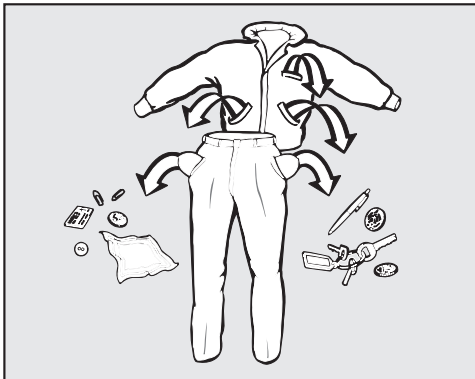

- Empty all pockets.

⚠ Damage due to foreign objects. Nails, coins, paper clips, and so on can cause damage to garments and components in the machine. Check the laundry before washing and remove any foreign objects.

Sort the laundry

- Sort the laundry by colour and by care label. Most garments have a textile care label in the collar or side seam.

Tip: Dark textiles often contain excess dye and should be washed separately several times before being included in a mixed load. Always wash whites and coloureds separately.

Pre-treating stains

- Badly soiled areas and stains should be cleaned as soon as possible, preferably whilst still fresh. Spillages should be carefully dabbed off using a soft, colourfast cloth. Do not rub.

Tip: Stains (e.g. blood, egg, coffee, tea) can be pre-treated using some handy tricks which can be found in the Miele guide to laundry care.

⚠ Damage due to solvent-based cleaning agents
Cleaning agents containing benzene, stain remover, etc., can damage plastic parts.
When pre-treating textiles, make sure that any plastic parts (e.g. buttons) do not come into contact with cleaning agent.

⚠ Risk of explosion due to solvent-based cleaning agents.
When using solvent-based cleaning agents, an explosive mixture may develop.
Never use solvent-based cleaning agents in the washing machine.

General tips

- Curtains: remove rollers and lead weights or place in a laundry bag.
- Sew in or remove any loose underwiring in bras.
- Close any zips, attach velcro fasteners, fasten hooks and eyes, etc. before washing.
- Fasten duvet covers and pillow cases to prevent small items from becoming rolled up inside them.

Do not wash items which are specified by the manufacturer as **not washable** according to the symbol on the care label (☒ symbol).

2. Select a programme

Switching on the washing machine

- Turn the programme selector to a programme.

Programme selection

There are three possible ways to select a programme:

1. Select standard programmes with the programme selector dial

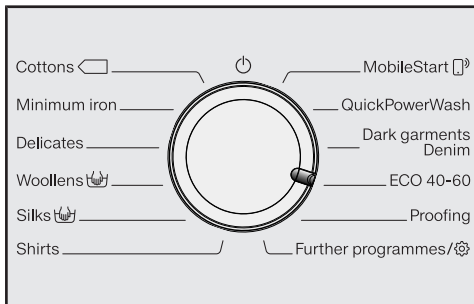

- Turn the programme selector to the required programme.

The selected programme will be shown in the display. The standard display will then appear.

2. Selecting additional programmes by setting the programme selector to “Further programmes/” and using the display:

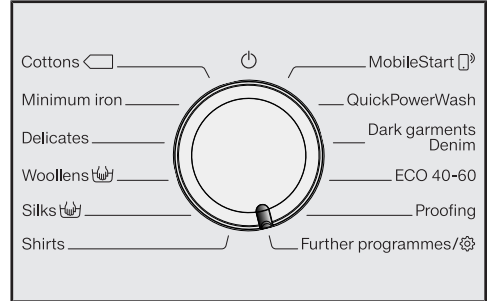

- Turn the programme selector to the *Further programmes/* position.

The following appears in the display:



- Touch the ∇/Δ sensor controls until the programme you want appears in the display.
- Confirm the programme with the OK sensor control.

Preset programme parameters will be displayed, depending on the programme selected.

2. Select a programme

3. Selecting programmes via the MobileStart programme selector position and the Miele app

Tip: In order to use *MobileStart* , the washing machine must be logged on to the WiFi network and Remote control must be switched on.

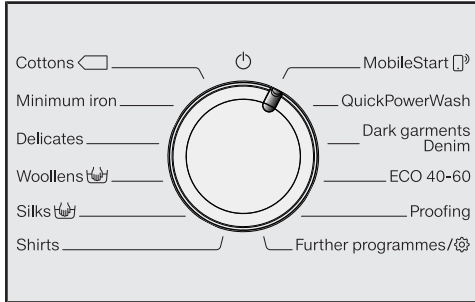

- Turn the programme selector to the *MobileStart*  position.

The following appears in the display:

 Load laundry, close the door and press "Start". Appliance can be remotely controlled

- Follow the instructions in the display and start the programme.

The following appears in the display:

 MobileStart 

The washing machine can now be operated with the Miele app.

3. Load the washing machine

Open the door

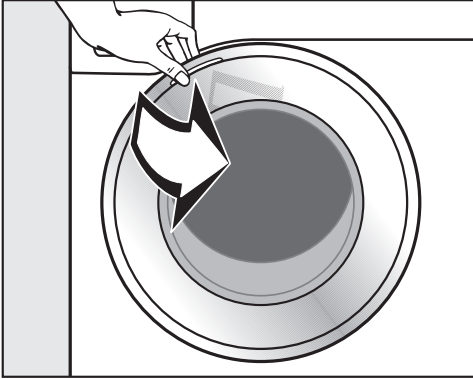

- Take hold of the door and pull it open.

Check the drum for pets or foreign objects before loading it with laundry.

The most efficient use of energy and water is achieved when a full load is washed. However, do not overload as this reduces cleaning efficiency and causes creases.

- Unfold the laundry and load loosely into the drum.

Mixing both large and small items gives better wash results and also helps distribute the load evenly during spinning.

Tip: Please note the maximum load for the different wash programmes. The relevant programme load is always shown in the display when you select a programme.

Close the door

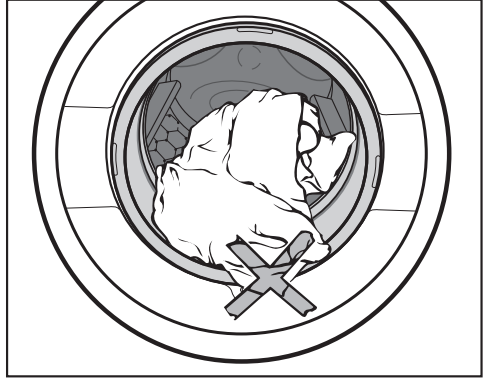

- Make sure that no items are caught between the door and the seal.

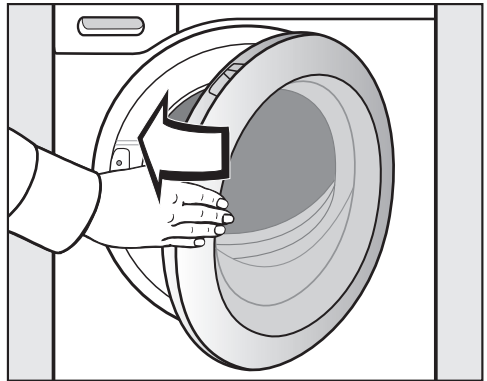

- Shut the door with a gentle swing.

4. Select programme settings

Selecting a temperature/spin speed

You can alter the preset temperature/spin speed of a wash programme if this option is permitted for that programme.

The temperatures reached inside the washing machine might not be the same as the temperatures selected. Perfect wash results are achieved through a combination of energy use and wash duration.



- Touch the ∨∧ sensor controls above or below the temperature or spin speed value in the display until the temperature/spin speed you want appears in the display.

Selecting an extra option

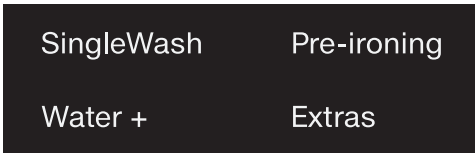

- Touch the sensor for the extra you want. It then lights up brightly.

Tip: You can select multiple Extras for a wash programme.

Not all extra options can be selected with every programme. If an extra option is not dimly lit, this option is not permitted for the wash programme (see “Extra options”).

Extras sensor control

You can select additional extras using the *Extras* sensor control.

- Touch the *Extras* sensor control.

The following appears in the display:



- Touch the ∨∧ sensor controls until the extra option you want appears in the display.
- Confirm the extra option with the OK sensor control.

Level of soiling

The  sensor is only active with the TwinDos option activated. See “5. Add detergent, TwinDos” for more information.

4. Select programme settings

◆ Delay start/SmartStart

Delay start

With the delay start function, you can delay the start of the programme.

This function is active when the setting SmartGrid is switched off.

The hours can be set from 00 to 24.
The minutes can be set in 15 minute increments from 00 to 45.

Setting the delay start time

- Touch the ◆ sensor control.

The following will appear in the display:



- Set the hours with the ∨∧ sensor controls. Confirm with the OK sensor control.

The display will change:



- Set the minutes with the ∨∧ sensor controls. Confirm with the OK sensor control.

Tip: The values will count upwards and downwards automatically if you keep your finger on the ∨∧ sensor control.

Cancelling delay start

The selected delay start period can be cancelled before the programme starts.

- Touch the ◆ sensor control.

The selected delay start period will appear in the display.

- Set a time value of 00:00 h with the ∨∧ sensor controls. Confirm with the OK sensor control.

The selected delay start time has been cancelled.

After the programme has started, the selected delay start period can only be changed or cancelled by interrupting the programme.

Altering delay start

The selected delay start time period can be changed before the programme start.

- Touch the ◆ sensor control.
- Change the specified time and confirm with the OK sensor control.

4. Select programme settings

SmartStart

The SmartStart function lets you define a period of time during which your washing machine will start automatically. The appliance will start on receipt of a signal, e.g. from your energy supplier, that indicates that the electricity tariff is particularly economical.

This function is active when the SmartGrid setting is switched on.

The time period can be defined between 15 minutes and 24 hours. During this period, the washing machine waits for the signal from the energy supplier. If no signal is sent during the defined period, the washing machine starts the wash programme.

Setting the time period

If you have activated the SmartGrid function in Settings, SmartStart instead of Start will appear in the display when you touch the  sensor control (see “Settings – SmartGrid”).

The procedure for setting this is the same as for setting the time for delay start.

- Use the ∇/\wedge sensor controls to enter the hour and confirm your entry with the *OK* sensor control.

The hour will be saved and the minute number block will be highlighted.

- Use the ∇/\wedge sensor controls to enter the minutes and confirm your entry with the *OK* sensor control.
- Press the *Start/Add laundry* sensor control to start the wash programme with SmartStart.

The following will appear in the display:



5. Add detergent

There are several options for adding detergent.

The washing machine has the TwinDos system.

TwinDos has to be activated as described in “Before using for the first time”.

How UltraPhase 1 and UltraPhase 2 work

UltraPhase 1 is a liquid detergent which dissolves dirt and removes the most common stains. UltraPhase 2 is a bleaching agent and removes stubborn stains. For the best washing result, these two agents are dispensed at separate times during the washing process. UltraPhase 1 and UltraPhase 2 clean white and coloured fabrics thoroughly. UltraPhase 1 and UltraPhase 2 single-use cartridges are available to order from Miele, your Miele dealer or via the Miele online shop.

Activating TwinDos dispensing

TwinDos dispensing is automatically activated for all programmes in which dispensing is possible.

Tip: The detergent dispensing quantities are preset. If too much foam builds up, the dispensing quantity can be reduced via Settings  TwinDos.

Changing TwinDos dispensing

You can change the suggested colour composition of the laundry.

- Touch the *Whites* or *Colours* sensor control.

Deactivating TwinDos dispensing

- Touch the *TwinDos* sensor control.

The sensor control is only dimly lit and dispensing is deactivated.

Using other methods to remove stains



If you wish to use additional methods of stain removal, you have the following options:

- Using the Booster cap and activating the CapDosing.
- Add stain remover to the  compartment.

5. Add detergent

Selecting the degree of soiling

The degree of soiling in laundry is divided into 3 settings:

-  Light
No visible soiling or stains
-  Normal
Visibly soiled and/or just a few slight stains
-  Heavy
Heavily soiled and/or stains clearly visible

The dispensing amount for TwinDos and the amount of water required for rinsing is preset for the  Normal degree of soiling.

- Touch the  sensor control to select a different degree of soiling.

The amount of detergent and water will be adjusted to suit the selected degree of soiling.

5. Add detergent

Detergent dispenser drawer

Any detergent suitable for automatic front loading washing machines can be used. Please observe the instructions for use and dosage on the detergent packaging.

Ensure that TwinDos dispensing is deactivated.

Adding detergent



- Pull out the detergent drawer and add detergent to the compartments.

- ☺ Detergent for the pre-wash
- ☺ Detergent for the main wash and soaking
- ☼ Fabric softener, liquid starch, or capsules

Adding fabric conditioner

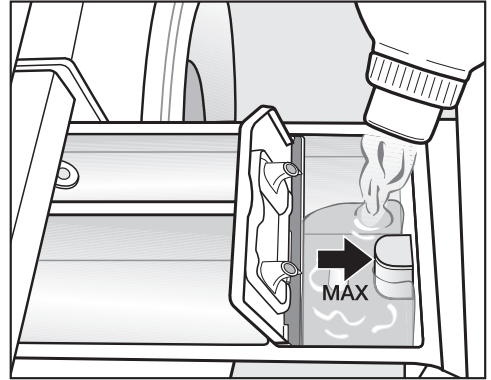

- Add fabric conditioner or liquid starch to the ☼ compartment. **Do not exceed the maximum level mark.**

It will be automatically dispensed in the final rinse. At the end of the programme a small amount of water remains in the ☼ compartment.

Starch can make the siphon tube sticky.

If starching frequently, thoroughly clean the dispenser compartment, especially the siphon tube, regularly.

5. Add detergent

Tips on dosing

Adjust the detergent dosage to the level of soiling of the laundry and the size of the load. Reduce the amount of detergent with smaller loads (e.g. reduce the amount of detergent by $\frac{1}{3}$ when washing a half load).

Too little detergent:

- Results in laundry not being cleaned properly and may cause it to become grey and hard to the touch over time.
- Can lead to a build-up of mould in the washing machine.
- Results in grease not being completely removed from the laundry.
- Can lead to limescale deposits on the heater elements.

Too much detergent

- Causes poor wash, rinse, and spin results.
- Causes higher water consumption as an extra rinse cycle is automatically activated.
- Is a greater burden on the environment.

Using liquid detergent with a pre-wash

Liquid detergent cannot be used for the main wash if the pre-wash has been selected.

Use TwinDos dispensing if you are activating the pre-wash.

Using detergent tablets or pods

Always put detergent tablets or pods directly in the drum with the laundry. They cannot be added via the detergent dispenser drawer.

See “Detergent” for further information.

5. Add detergent

CapDosing

Three different types of capsule are available:

- ☼ = Fabric care (e.g. fabric conditioner, proofing agent)
- ☼ = Additives (e.g. detergent enhancer)
- ☼ = Detergent (for the main wash only)

Each capsule contains the correct amount for one wash cycle.

Caps are available to order from Miele or from the Miele online shop (see the end of this booklet for contact details).

⚠ Capsules pose a health risk. The ingredients of capsules can be hazardous to health if they are swallowed or come into contact with skin. Keep capsules out of the reach of children.

Activating CapDosing

- Touch the  sensor control.

The following appears in the display:



- Touch the  sensor controls until the capsule you want appears in the display.
- Confirm the capsule with the **OK** sensor control.

Inserting a capsule

- Open the detergent dispenser drawer.

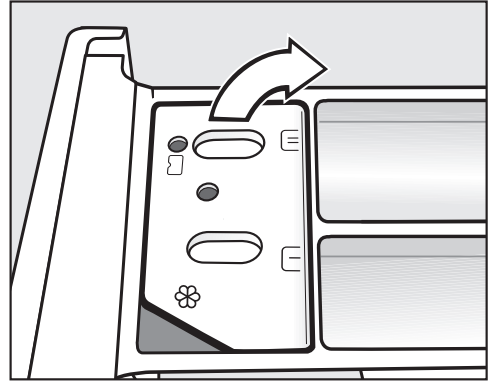

- Open the lid of the  compartment.

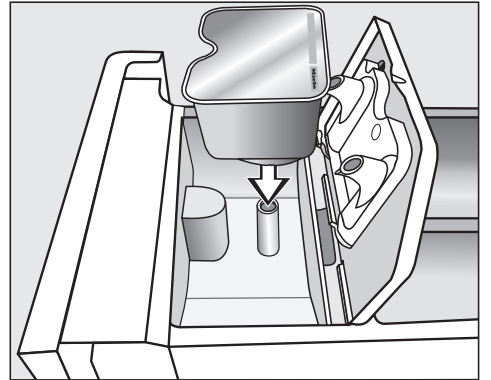

- Press the capsule in firmly.



5. Add detergent



- Close the lid and press it firmly shut.
- Close the detergent dispenser drawer.

The capsule is opened by the act of inserting it in the detergent dispenser drawer. The contents can run out of the capsule if you then remove it from the drawer before it is used. Dispose of opened capsules.

The wash programme will dispense the contents of the capsule at the correct time.

Water intake to the  compartment is solely via the capsule. Do not add any additional fabric conditioner to the  compartment.

- Remove the empty capsule at the end of the programme.

For technical reasons a small amount of water will remain in the capsule.

Deactivating or changing CapDosing

CapDosing can only be deactivated or changed prior to the programme start.

- Touch the  sensor control.
- Select No Cap (deactivate) or a different type of capsule (change).

6. Starting the programme



- Touch the flashing *Start/Add laundry* sensor control.

The door will lock and the programme will start.

The programme status will appear in the display.

The washing machine will keep you updated on the programme status and the time remaining for the programme to run.

If a delay start period has been selected, this will appear in the display.

Energy savings

After 10 minutes, the indicators dim. The sensor control *Start/Add laundry* flashes.

To reactivate the indicators:

- Touch the *Start/Add laundry* sensor control (this does not have any effect on a programme that is running).

Adding laundry during a programme sequence (AddLoad)

Laundry can be added or removed at any time, provided that the  symbol is not illuminated in the display.

- Touch the *Start/Add laundry* sensor control.

The following appears in the display:

 Please wait

- Wait until the following display lights up:
 -  Door can be opened
- Open the door and add or remove laundry.
- Close the door.
- Touch the *Start/Add laundry* sensor control.

The programme will continue.

Laundry cannot usually be added or removed if:

- The suds temperature is above 55 °C
- The water inside the drum is above a certain level

7. End of programme

Opening the door and removing the laundry

The door remains locked during the anti-crease phase. The display will change to show:

Finish/Anti-crease

i Press Start button

- Unlock the door either by touching the *Start/Add laundry* sensor control or by turning the programme selector to the  position.

The door will unlock.

Tip: After the anti-crease phase, the door will have unlocked automatically.

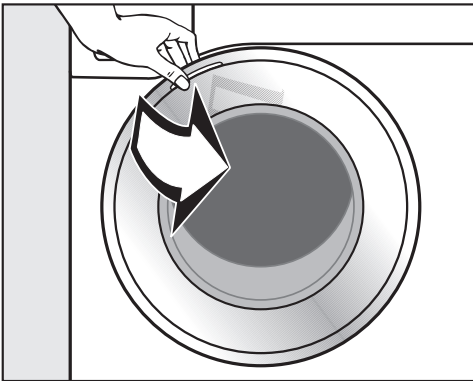

- Take hold of the door and pull it open.
- Remove the laundry.

Items left in the drum could discolour other items in the next wash or become discoloured themselves. Remove all items from the drum.

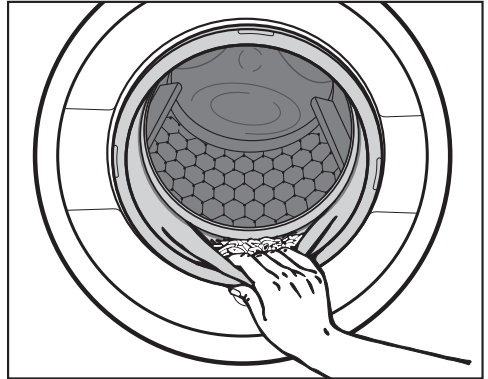

- Check the door sealing ring for any foreign objects.

Tip: Leave the door slightly open to allow the drum to dry.

- If applicable, remove the used capsule from the detergent drawer.



Tip: Leave the detergent drawer slightly open to allow it to dry.

Final spin speed in the programme

When a programme is selected, the optimum spin speed for this wash programme is shown in the display.

A faster spin speed can be selected for certain wash programmes.

The highest selectable spin speed is indicated in the table.

Programme	rpm
Cottons	1600
Minimum iron	1200
Delicates	900
Woolens 	1200
Silks 	600
Shirts	900
QuickPowerWash	1600
Dark garments/Denim	1200
ECO 40-60	1600
Proofing	1000
Cottons hygiene	1600
Outerwear	800
Express 20	1200
Sportswear	1200
Automatic plus	1400
Pillows	1200
Curtains	600
Down filled items	1200
First wash	1200
Down duvets	1200
Separate rinse/Starch	1600
Drain/Spin	1600
Clean machine	600

Spinning

Interim spin

There is a spin cycle after the main wash and between the rinses. A reduction in the final spin speed will also reduce the interim spin speed as appropriate.

Omitting the final spin (Rinse hold)

- Set the spin speed to  (Rinse hold).

The laundry is not spun after the final rinse and remains in the rinse water. This helps to prevent creasing if the laundry is not going to be removed from the drum immediately after the end of the programme.

Ending a programme with a spin cycle

The display shows  Rinse hold alternately with the ideal spin speed.

- Touch the *Start/Add laundry* sensor control to start the final spin.

Ending a programme without a spin cycle

- Reduce the spin speed to 0.
- Touch the flashing *Start/Add laundry* sensor control.

Omitting the interim-spin and the final spin

- Before the start of the wash programme, reduce the spin speed to 0.



After the last rinse, the water will be pumped away and the anti-crease phase will switch on.

In some programmes an additional rinse is introduced with this setting.

Programmes on the programme selector

Cottons		90 °C to cold	Max. load 9.0 kg
Items	Cotton, linen or mixed fibre fabric, e.g. table linen, underwear, T-shirts, etc.		
Tip	Where particularly high levels of hygiene are required, please select a temperature of 60 °C or higher.		
Cottons 		60°C / 40°C	Max. load 9.0 kg
Items	Normally soiled cotton garments		
Tip	<ul style="list-style-type: none"> - Cottons 60°C is the recommended program designed to minimize water consumption for normally soiled load at rated capacity. - With 60°C, the wash temperature reached is below 60 °C. The wash performance is the same as with the <i>Cottons</i> 60 °C programme. 		
Note for test institutes:			
The test programme conforms to EN 60456.			
Minimum iron		Cold to 60 °C	Max. load 4.0 kg
Items	Synthetic and mixed fibre textiles as well as easy care cotton		
Tip	Reduce the spin speed for fabric that creases easily.		
Delicates		Cold to 60 °C	Max. load 3.0 kg
Items	Delicate garments made from synthetic fibre, mixed fibre and viscose		
Tip	Deselect the spin for items which crease easily.		

Programme chart

Woollens 		Cold to 40 °C	Max. load 2.0 kg
Items	Wool or wool blend fabric		
Tip	Reduce the spin speed for fabric that creases easily.		
Silks 		Cold to 30 °C	Max. load 1.0 kg
Items	Silks and other handwashable fabrics with no wool content, e.g. satin, lace and silk		
Tip	Place tights, bras etc. in a laundry bag.		
Shirts		Cold to 60 °C	Max. load 1.0 kg/2.0 kg
Items	Shirts and blouses made of cotton and mixed fibre		
Tip	<ul style="list-style-type: none"> - Pre-treat collars and cuffs depending on the level of soiling. - Wash silk shirts and blouses in the <i>Silks</i> programme. - If the preset <i>Pre-ironing</i> Extra is switched off, the maximum load capacity is increased to 2.0 kg. 		
MobileStart 			
The Miele app is used for selecting programmes and operating the appliance.			
QuickPowerWash		60 °C – 40 °C	Max. load 4.0 kg
Items	Lightly to moderately soiled garments which are also suitable for washing in the <i>Cottons</i> programme		
Tip	A special saturation process and wash rhythm ensure that the laundry is cleaned particularly quickly and thoroughly.		

Programme chart

Dark garments/ Denim		Cold to 60 °C	Max. load 3.0 kg
Items	Black and dark items made of cotton, mixed fibre or denim		
Tip	<ul style="list-style-type: none"> - Wash inside out. - Denim often contains excess dye and may run during the first few washes. Therefore, wash light and coloured items separately. 		
ECO 40-60		Max. load 9.0 kg	
Items	For normally soiled cotton garments		
Tip	<p>A laundry load consisting of mixed cottons that are intended for washing at 40 °C or 60 °C can be washed in the same wash cycle.</p> <p>This programme is the most efficient in terms of energy and water consumption for washing cottons.</p>		
<p>Note for test institutes:</p> <p>Test programme for compliance with EU legislation regarding ecodesign No. 2019/2023 and energy labelling in accordance with Regulation No. 2019/2014.</p> <p>TwinDos dispensing must be deactivated when carrying out comparison tests.</p>			
Proofing		40 °C	Max. load 2.5 kg
Items	Treating microfibre fabric, ski wear or table linen made from mainly synthetic fibres to provide a finish which is resistant to water and dirt		
Tip	<ul style="list-style-type: none"> - The items must be freshly laundered and spun or dried before proofing. - For best results, the items should be heat-treated afterwards. This can be achieved by drying them in the tumble dryer or ironing them. 		

Programme chart

Programmes accessed via Further programmes/ on the programme selector

Cottons hygiene		90 °C to 60 °C	Max. load 9.0 kg
Use for	Cotton or linen with direct skin contact or for items which have special hygiene requirements, e.g. underwear, bed linen, encasing products		
Tip	<ul style="list-style-type: none"> - Safe removal of viruses and bacteria in combination with the <i>AllergoWash</i> extra option and detergent dispensing via TwinDos with UltraPhase1 and 2. Tested and confirmed by the Albstadt-Sigmaringen University. - Temperature holding times are longer than in the <i>Cottons</i> programme. - Follow the instructions on the care label. 		
Outerwear		Cold to 40 °C	Max. load 2.5 kg
Items	Performance outerwear (e.g. jackets and trousers) made from membrane fabric such as Gore-Tex®, SYMPATEX®, WINDSTOPPER®, etc.		
Tip	<ul style="list-style-type: none"> - Zip up or close any jackets with Velcro before washing. - Do not use fabric conditioner. - If required, these items can also be re-proofed using the <i>Proofing</i> programme. Proofing after each wash cycle is not recommended. 		
Express 20		Cold to 40 °C	Max. load 3.5 kg
Items	Cotton garments that have hardly been worn or are only very lightly soiled		
Tip	The <i>Quick Extra</i> is activated automatically.		
Sportswear		Cold to 60 °C	Max. load 3.0 kg
Items	Sportswear such as singlets and leggings as well as microfibre and fleece garments		
Tip	<ul style="list-style-type: none"> - Do not use fabric conditioner - Follow the instructions on the care label 		

Programme chart

Automatic plus		Cold to 40 °C	Max. load 6.0 kg
Items	Mixed loads of garments sorted according to colour which are suitable for the <i>Cottons</i> and <i>Minimum iron</i> programmes		
Tip	The wash parameters (e.g. water level, wash rhythm and spin speed) are adjusted automatically in this programme to ensure the best possible care and wash result for each item.		
Pillows		Cold to 60 °C	2 pillows (40 x 80 cm) or 1 pillow (80 x 80 cm)
Items	Washable pillows with synthetic filling		
Tip	<ul style="list-style-type: none"> - Remove air from the laundry before washing to prevent an excessive build-up of foam. To do this either push the items into a narrow laundry bag to compress them or tie them together with a washable strap. - Follow the instructions on the care label 		
Curtains		Cold to 40 °C	Max. load 2.0 kg
Items	Curtains specified as machine-washable by the manufacturer		
Tip	<ul style="list-style-type: none"> - To remove dust, the <i>Pre-wash Extra</i> is selected automatically. - For curtains which crease easily, reduce the spin speed or deselect the spin. - Remove weights from curtains 		
Down filled items		Cold to 60 °C	Max. load 2.0 kg
Items	Jackets, sleeping bags, pillows and other items with down filling		
Tip	<ul style="list-style-type: none"> - Remove air from the laundry before washing to prevent an excessive build-up of foam. To do this either push the items into a narrow laundry bag to compress them or tie them together with a washable strap. - Follow the instructions on the care label 		

Programme chart

First wash		Cold to 40 °C	Max. load 2.0 kg
Items	New items made of cotton, towelling and polyester fabric		
Tip	Use this programme to wash any manufacturing residues out of new items.		
Down duvets		Cold to 60 °C	Max. load 2.5 kg 1 down duvet 2.20 m x 2.00 m
Items	Quilts, duvets and pillows with feather or down filling		
Tip	<ul style="list-style-type: none"> - Remove air from the laundry before washing to prevent an excessive build-up of foam. To do this either push the items into a narrow laundry bag to compress them or tie them together with a washable strap. - Follow the instructions on the care label 		
Separate rinse/Starch			Max. load 8.0 kg
Items	<ul style="list-style-type: none"> - Rinsing hand-washed items - Table cloths, serviettes and workwear requiring starching 		
Tip	<ul style="list-style-type: none"> - Reduce the spin speed for fabric that creases easily. - Laundry that is to be starched should be washed but not treated with fabric conditioner. - Items will be rinsed very effectively with 2 rinses by activating the <i>Water + extra</i>. 		
Drain/Spin			-
Tip	<ul style="list-style-type: none"> - Drain: Set the spin speed to 0 rpm - Make sure you select the appropriate spin speed 		

Settings /maintenance

Settings

You can use the settings function to alter the washing machine's electronics to suit changing requirements. See “Settings” for more detailed information.

Maintenance

The washing machine has two maintenance programmes.

1. Clean machine for cleaning the washing machine.
2. TwinDos mainten. for maintenance of the TwinDos compartments ①/②. See “Cleaning and care – TwinDos maintenance” for more details.

Clean machine	85 °C	No load
<p>With frequent washing at low temperatures there is a danger of a build-up of bacteria in the washing machine.</p> <p>Cleaning the washing machine will significantly reduce bacteria, mould and biofilm, as well as prevent the build-up of unpleasant odours.</p>		
<p>Tip</p>	<ul style="list-style-type: none"> - Optimum results can be achieved by using Miele’s IntenseClean washing machine cleaner. Alternatively, a universal powder detergent can be used. - Dispense the washing machine cleaner or universal detergent directly in the drum. - Do not load any laundry. The drum must be empty for the Clean Machine programme. 	

Garment care label symbols

Washing	
The figure quoted in the bucket is the maximum temperature at which the garment can be washed.	
	Normal agitation
	Reduced agitation
	Much reduced agitation
	Hand wash
	Do not wash

Programme selection examples

Programme	Garment care label symbols
Cottons	
Minimum iron	
Delicates	
Woollens	
Silks	
Express 20	
Automatic plus	

Drying	
	Normal temperature
	Low temperature
	Do not tumble dry

Ironing	
	Approx. 200 °C
	Approx. 150 °C
	Approx. 110 °C
	Ironing with steam can cause irreversible damage.
	Ironing/rotary ironing prohibited

Professional cleaning	
	Dry clean only. The letters indicate the type of cleaning agent required.
	Wet cleaning
	Dry cleaning prohibited

Bleaching	
	Any oxidation bleach can be used
	Use oxygen bleach only
	Do not bleach

You can use the extra options buttons to augment the wash programmes.

Selecting Extras

Extra options are selected or deselected using the sensors in the control field. Additional extra options can be selected from the display using the *Extras* sensor.

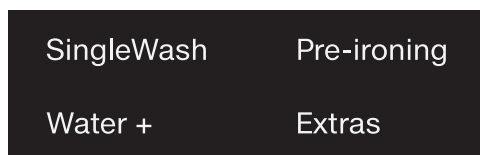

- Touch the sensor for the extra option you want.

The relevant sensor will light up brightly.

Not all extra options can be selected with every programme.

An extra option that is not permitted for the wash programme is not lit dimly and cannot be activated by touch.

SingleWash





For efficiently washing a very small load (< 1 kg) in a normal wash programme. The wash duration is reduced.

Please note the following advice:

- Use liquid detergent.
- Reduce the dosage to a maximum of 50 % of the amount quoted for a ½ load.

Pre-ironing

In order to reduce creasing, the laundry undergoes a smoothing process at the end of the programme. Reducing the maximum load by 50 % will achieve a better result. Follow the instructions in the display. Small loads achieve a better result.

The garments must be suitable for drying in a tumble dryer   and suitable for ironing  .

Water +

The water level in the main wash and the rinses will be increased. A second rinse cycle is carried out in the “*Separate rinse/Starch*” programme.

You can select other functions for the *Water +* extra option. These are described in “Settings”.

Extra options

Extra options can be selected using the Extras sensor control

Selecting extra options in the display

- Touch the Extras sensor control.

The following appears in the display: No Extras

- Touch the \vee/\wedge sensor controls until the extra option you want appears in the display.
- Confirm the extra option with the *OK* sensor control.

The extra option will be given a \checkmark next to it.

Deselecting an extra option

- Touch the *Extras* sensor control.

The first extra option which can be selected appears in the display.

- Touch the \vee/\wedge sensor controls until *No Extras* appears in the display.
- Confirm *No Extras* with the *OK* sensor control.

The previously selected extra option is now deselected.

Quick

The programme duration is reduced. Mechanical action and energy usage are increased.

Stains

For cleaning stained laundry. The programme sequence is altered with this option.

Pre-wash

For laundry with large amounts of dirt, e.g. dust and sand.

Soak

For heavily soiled and stained items with protein stains.

A duration of between 30 minutes and 6 hours in 30-minute increments can be selected for the soak process. See “Settings” for more information.

The factory default setting is 30 minutes.

Intensive

For hard-wearing laundry that is very heavily soiled. Cleaning efficiency is increased through more intense mechanical action and the application of more heat energy.





Extra quiet

This option reduces noise levels during the wash programme. Use this if you want to wash during quiet periods (for instance when children are sleeping). The final spin is automatically reduced to  (Rinse hold). The programme duration is increased.



Extra gentle

Drum rotation and wash duration are reduced. Lightly soiled fabrics are washed more gently.

AllergoWash

This option should be used where high standards of hygiene are required. Energy consumption is increased to lengthen temperature holding times and water consumption is increased to improve rinsing efficiency. The items must be suitable for drying in a tumble dryer   and suitable for ironing 
.

Wash programme chart - Extras

	SingleWash	Pre-ironing	Water +	Quick
Cottons	●	●	●	●
Minimum iron	●	●	●	●
Delicates	●	●	●	●
Woolens 	●	-	-	-
Silks 	●	-	-	-
Shirts	●	✓	●	●
QuickPowerWash	●	●	-	✓
Dark garments/Denim	●	●	●	●
ECO 40-60	-	-	-	-
Proofing	-	-	-	-
Cottons hygiene	-	●	●	●
Outerwear	-	-	●	●
Express 20	-	●	-	✓
Sportswear	●	-	●	●
Automatic plus	●	●	●	●
Pillows	-	-	●	●
Curtains	●	●	●	●
Down filled items	-	-	●	●
First wash	●	●	●	-
Down duvets	-	-	●	●
Separate rinse/Starch	-	-	●	-
Clean machine	-	-	-	✓

Wash programme chart - Extras

Stains	Pre-wash	Soak	Intensive	Extra quiet	Extra gentle	Allergo-Wash
●	●	●	●	●	●	●
●	●	●	●	●	●	●
●	●	●	-	●	●	●
-	-	-	-	●	-	-
-	-	-	-	●	-	-
●	●	●	-	●	●	●
-	-	-	-	-	-	-
●	●	●	-	●	●	●
-	-	-	-	-	-	-
-	-	-	-	-	-	-
●	●	●	-	●	●	●
●	●	●	-	●	●	-
-	-	-	-	-	-	-
●	●	●	-	●	●	●
●	●	●	-	●	●	●
●	●	-	-	●	●	●
●	●	-	-	●	●	●
●	✓	-	-	●	●	●
-	-	-	-	●	●	-
●	●	-	-	●	●	●
-	-	-	-	●	-	-
-	-	-	-	-	-	-

● = can be selected



✓ = activated automatically

- = cannot be selected

Programme sequence

	Main wash		Rinses		Spinning
	Water level	Wash rhythm	Water level	Rinses	
Cottons		(A)		2-5 ^{1,2,3}	✓
Cottons		(A)		2-5 ^{2,3}	✓
Minimum iron		(B)		2-4 ^{2,3}	✓
Delicates		(C)		2-4 ^{2,3}	✓
Woolens		(E)		2	✓
Silks		(E)		2	✓
Shirts		(C)		3-4 ³	✓
QuickPowerWash		(A)		2	✓
Dark garments/Denim		(B)		3-5 ^{2,3}	✓
ECO 40-60		(A)		2-3 ²	✓
Proofing	-	(B)		1	✓
Cottons hygiene		(A)		2-4 ^{2,3}	✓
Outerwear		(C)		3-4 ³	✓
Express 20		(A)		1	✓
Sportswear		(C)		2-3 ³	✓
Automatic plus		(A)(B)		2-4 ^{2,3}	✓
Pillows ⁴		(C)		3-4 ³	✓
Curtains		(C)		3-4 ³	✓
Down filled items ⁴		(C)		3-4 ³	✓
First wash		(B)		2-3 ³	✓
Down duvets		(C)		3-4 ³	✓
Separate rinse/Starch		(B)		0-1 ⁵	✓
Drain/Spin	-	-	-	-	✓
Clean machine		(A)		3	✓

Please see the next page for a description of the symbols.

-  = low water level
 = medium water level
 = high water level
Ⓐ = intensive rhythm
Ⓑ = normal rhythm
Ⓒ = sensitive rhythm
Ⓔ = handwash rhythm
✓ = carried out
- = not carried out

This washing machine has fully electronic controls with automatic load control. The washing machine takes in the right amount of water required for the programme depending on the amount of laundry and its absorbency rate.



The programme sequences outlined in the chart are based on the basic programme with a full load.

The washing machine programme sequence display shows which stage of the programme has been reached.

Special features in the programme sequence

Anti-crease:

At the end of the programme, the drum continues to turn at intervals for up to 30 minutes to help prevent creasing.

Exception: There is no anti-crease phase in the *Woolens*  and *Silks*  programmes.

The washing machine can be opened at any time.

- ¹ If a temperature of 60 °C or higher is selected, and with <40°C and <60°C, two rinses are carried out. If a temperature of less than 60 °C is selected, three rinses are carried out.
- ² An additional rinse is carried out if:
 - there is too much foam in the drum
 - a spin speed lower than 700 rpm has been selected.
- ³ An additional rinse is carried out if:
 - The *Water* + extra option has been selected and the options *Extra water* or *Extra water + rinse* have been activated in the *Settings* menu.
- ⁴ Run-up to spin: A run-up to spin is carried out before the wash process begins to deflate down-filled items. Subsequent water intake for the main wash is through compartment .
- ⁵ An additional rinse is carried out if: the *Water* + extra option has been selected.

Programme sequence

PowerWash

PowerWash is a washing technique developed by Miele. It is activated in the following programmes:

- Cottons (with small and medium load sizes)
- Minimum iron
- Shirts
- Automatic plus
- Delicates
- ECO 40-60 (with small and medium load sizes)

How it works

Conventional washing techniques wash with more water than the laundry can absorb. This total volume of water needs to be heated.

The PowerWash washing technique only uses slightly more water than the laundry can absorb. The water which has not been absorbed by the laundry heats up the drum and the laundry and is sprayed into the laundry over and over again. This reduces energy consumption.

Activation

PowerWash is activated **automatically** in the programmes listed above.

PowerWash is deactivated if:

- The selected final spin speed is less than 600 rpm
- CapDosing (☉, ☽) has been selected for the main wash
- The wash temperature is higher than 60 °C
- Extras such as *Pre-wash* or *Water +* have been selected
- A large load is being washed in the *Cottons* programme

Special features

- Drenching phase

The washing machine will spin a few times at the beginning of the programme. During spinning, the water discharged is sprayed back into the laundry in order to achieve optimum moisture penetration.

The optimum water level is set at the end of the drenching phase. If necessary, the washing machine will pump water away or take in a little more fresh water.

- Noises during the heating phase

Unusual bubbling noises can occur while the laundry and the drum are being heated.

Changing the programme sequence

Changing a programme (safety lock)

A programme, temperature, spin speed or selected options cannot be changed once the machine has been successfully started. This prevents the machine being operated unintentionally, e.g. by children.

If the washing machine is switched off during active programme operation, the standby function does not switch the washing machine off completely after 15 minutes. Safety functions continue to be active because there may still be water inside the drum.

Interrupting a programme

- Turn the programme selector to the  position.

The washing machine switches off.

- To continue: turn the programme selector to the position of the wash programme that was started.



- Touch the  sensor control.

The following will appear in the display:



- Confirm with the *OK* sensor control.

Tip: If  **Cannot be changed** appears in the display, the programme selector is in the incorrect position.

Cancelling a programme

You can cancel a wash programme at any time after it has started.

- Turn the programme selector to the  position.
- Turn the programme selector to the *Cottons* programme.

The following will appear in the display:



- Touch the *OK* sensor control.

The suds are pumped away. The following will appear in the display:



- Wait until the  symbol in the display goes out and the door unlocks.
- Pull open the door.
- Remove the laundry.

Detergent

The correct detergent

All detergents produced for automatic washing machines are suitable. Follow the manufacturer's instructions and dosage recommendations on the packaging.

For users in Asia:

please use a low foaming detergent suitable for use in front-loading machines

The right amount to dispense will depend on the following:

- the soiling level of the load
- the quantity of the laundry
- the water hardness level.
Check with your local water supplier if you do not know the hardness level in your area.

Water softeners

A water softener can be used to cut down on the use of detergents in areas with water hardness levels II and III.

Dispense according to the amount specified on the packaging. First add detergent and then the water softener.

You can then use the recommended amount of detergent for water hardness level I.

Water hardness levels

Hardness scale	Hardness level in mmol/l	German scale °d
I (soft)	0 – 1.5	0 – 8.4
II (medium)	1.5 – 2.5	8.4 – 14
III (hard)	above 2.5	above 14

Dispensing aids

Use dispensing aids, (e.g. balls) if these are supplied with the detergent, particularly when using liquid detergent.

Refill packs of detergent

When purchasing detergent buy refill packs wherever possible. This helps reduce the amount of waste packaging.

Fabric conditioner and liquid starch

Fabric conditioner

makes garments soft to handle and helps prevent static cling when tumble drying.

Starch

stiffens and gives body to items of laundry, e.g. shirts, tablecloths and bed linen.

Adding fabric conditioner or liquid starch separately

Prepare the starch in accordance with the manufacturer's instructions on the packaging.

Tip: When adding fabric conditioner, activate the *Water* + extra option.

Dispensing fabric conditioner via TwinDos

One of the automatic dispensing containers must be filled with fabric conditioner.

- Select the *Separate rinse/Starch* programme.
- Touch the *TwinDos* sensor control.
- Activate the appropriate container.
- Touch the *Start/Add laundry* sensor control.

Dispensing fabric conditioner or liquid starch via the detergent drawer

- Add fabric conditioner to the ☼ compartment or insert the appropriate capsule.
- Add liquid starch to the ☼ compartment and powder or viscous starch to the ☐ compartment.
- Select the *Separate rinse/Starch* programme.
- Change the spin speed if necessary.
- Activate the  sensor control if using a capsule.
- Touch the *Start/Add laundry* sensor control.

Colour run and dye removers/dyes

 Damage due to colour run/dye removers.

Colour run and dye removers can cause corrosion in the washing machine.

Do not use colour run or dye removers in this washing machine.





Dyes suitable for use in domestic washing machines can be used. However, please note that the salt used in the dyeing process can cause corrosion to stainless steel components in the machine if you use dye frequently. Always follow the dye manufacturer's instructions carefully.

When using the machine to dye fabric, it is essential to select the *Water* + extra.



Detergent

Recommended Miele detergents

Miele detergents have been specially designed for day-to-day use in Miele washing machines. See “Detergents and care products” for more information about these detergents.

	Miele UltraPhase 1 and 2	Miele single-use capsules		
				
Cottons	✓	-	✓	✓
Minimum iron	✓	-	✓	✓
Delicates	✓	✓	✓	-
Woolens 	-	✓	-	-
Silks 	-	✓	-	-
Shirts	✓	-	✓	✓
QuickPowerWash	✓	-	-	-
Dark garments/Denim	✓	✓	✓	-
ECO 40-60	✓	-	✓	✓
Cottons hygiene	✓	-	✓	✓
Outerwear	-	✓	-	-
Express 20	✓	-	✓	-
Sportswear	-	✓	-	-
Automatic plus	✓	-	✓	✓
Pillows	✓	-	-	-
Curtains	✓	-	-	✓
Down filled items	-	✓	-	-
First wash	✓	-	✓	-
Down duvets	-	✓	-	-
Separate rinse/Starch	-/-	-/-	✓/-	-/-

- ✓ Recommendation
- No recommendation

-  Specialist detergents (e.g. WoolCare)
-  Fabric care (e.g. fabric conditioner)
-  Additive (e.g. booster)

Recommended detergents in accordance with Directive (EU) Nr. 1015/2010

The recommendations apply to the temperature ranges given in the Programme chart.

	Universal	Coloureds	Delicates and woollens	Specialist
	detergent			
Cottons	✓	✓	-	-
Minimum iron	-	✓	-	-
Delicates	-	-	✓	-
Woollens 🧶	-	-	✓	✓
Silks 🧶	-	-	✓	✓
Shirts	✓	✓	-	-
QuickPowerWash	✓	✓	-	-
Dark garments/Denim	-	✓ ¹	-	✓
ECO 40-60	✓	✓	-	-
Cottons hygiene	✓	✓	-	-
Outerwear	-	-	✓	✓
Express 20	-	✓ ¹	-	-
Sportswear	-	-	✓	✓
Automatic plus	-	✓	-	-
Pillows	-	-	✓ ¹	✓
Curtains	✓ ²	-	-	✓
Down filled items	-	-	✓ ¹	✓
First wash	-	✓	-	-
Down duvets	-	-	✓ ¹	✓
Clean machine	✓ ²	-	-	✓

✓ Recommendation

- No recommendation

1

Liquid detergent

2

Powder detergent

Replacing the TwinDos cartridge

A message will appear in your washing machine display if a detergent cartridge is empty.

Preparing the cartridge

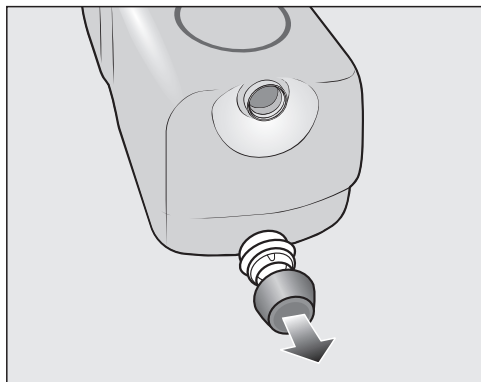

- Remove the cover cap from the cartridge.

or

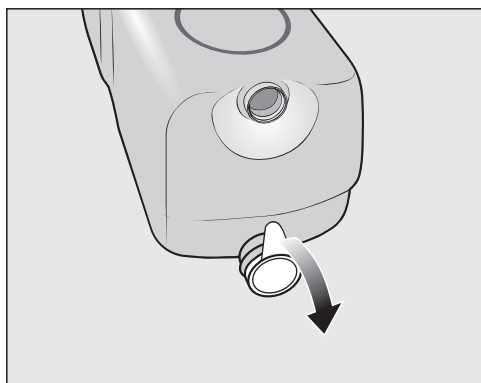

- Remove the film seal from the cartridge completely.

 Risk of damage from film seal
If the film seal is not removed completely, leaks can occur in the TwinDos system.

Remove the film seal from the suction port on the cartridge completely before inserting the new cartridge.

Replacing the cartridge

- Switch on the washing machine.

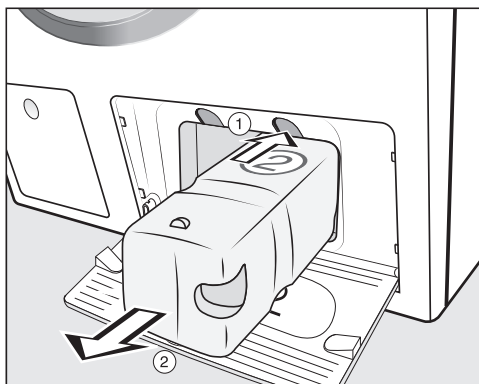

① To release the lock, press the yellow button above the cartridge.

② Pull out the cartridge.

- Insert a new cartridge.
- Confirm the messages in the display.

The counter is set to 0.

Cleaning the external casing and the control panel

⚠ Risk of electric shock!
Mains voltage is present when the washing machine is switched off
Disconnect the machine from the electricity supply before cleaning or maintenance.

⚠ Risk of damage due to ingress of water.
The pressure of a water jet can cause water to get into the washing machine, resulting in damage to components.
Do not spray the washing machine with a water jet.

- Clean the casing and control panel with a mild cleaning agent or soap and water and dry both with a soft cloth.
- The drum can be cleaned using a suitable stainless steel cleaning agent following the manufacturer's instructions on the packaging.

⚠ Damage caused by cleaning agents.
Solvent based cleaning agents, abrasive cleaners, glass cleaners or multi-purpose cleaning agents can cause damage to plastic surfaces and other parts.
Do not use any of these cleaning agents.

Cleaning the detergent dispenser drawer

Washing at low temperatures and the use of liquid detergent can lead to a build-up of bacteria in the detergent dispenser drawer.

- Clean the entire drawer at regular intervals for hygiene reasons, even if you are using the TwinDos system exclusively.

Removing the detergent drawer

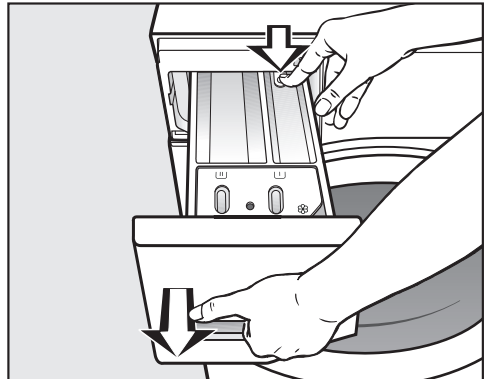

- Pull out the detergent dispenser drawer until a resistance is felt. Press down the release button and at the same time pull the drawer right out of the machine.
- Clean the detergent drawer with warm water.

Cleaning and care

Cleaning the siphon and the compartment channel

Liquid starch results in clogging. If clogged, the siphon in the  compartment will not work and the compartment can overflow.

Clean the siphon particularly thoroughly after using liquid starch a few times.

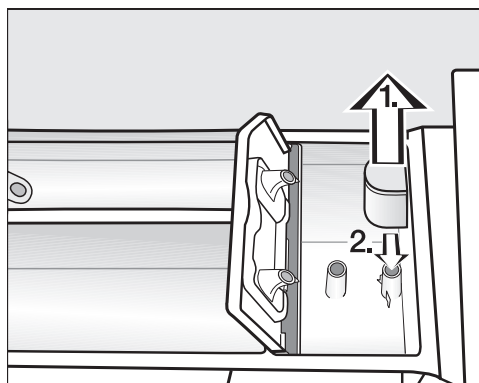

1. Remove the siphon from  compartment and clean under warm running water. Clean the siphon tube in the same way.
2. Replace the siphon.

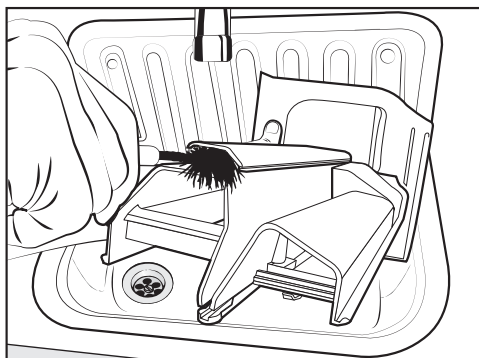

- Clean the fabric conditioner channel using a brush and warm water.

Cleaning the detergent dispenser drawer compartment

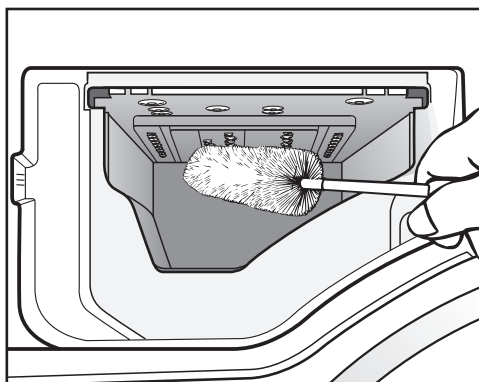

- Use a bottle brush to remove detergent residues and limescale from the jets inside the detergent dispenser drawer compartment.
- Refit the detergent drawer.

Tip: To assist drying, leave the detergent drawer slightly open.

TwinDos maintenance

 Damage resulting from dried laundry detergent.

If the system has not been used for a long time (more than two months), detergent in the hoses can become viscous or dry out. The hoses can become blocked and would then need to be cleaned by a service technician.

Clean the TwinDos system.

To clean the system, you either need a “TwinDosCare” cleaning cartridge or a TwinDos refill cartridge, both of which are available to purchase from www.shop.miele.com.

The washing machine has a cleaning programme for the TwinDos system. Running the cleaning programme will clean the hoses inside the washing machine.

Starting the maintenance programme

- Turn the programme selector to the *Further programmes*/ position.



- Touch the ∇/Δ sensor controls until the following appears in the display:



- Confirm the setting with the *OK* sensor control.

- Touch the ∇/Δ sensor controls until the following appears in the display:



- Confirm the setting with the *OK* sensor control.



- Touch the ∇/Δ sensor controls until the compartment you want appears in the display. Confirm with the *OK* sensor control.



- Touch the ∇ sensor control until the following appears in the display:



- Confirm the setting with the *OK* sensor control.
- Follow the instructions in the display.

This cleans the hoses. The TwinDos system can then be used again at any time.

Cleaning the compartment

Detergent residue can cause clogging.

- Use a damp cloth to clean the compartment interior when you change the cartridge or container.

Cleaning and care

Hygiene info (Cleaning the drum)

Washing at low temperatures and/or using liquid detergents can cause bacteria and odours to build up in the washing machine. Use the *Clean machine* programme to clean the washing machine. Note the message in the display:

Hygiene info: run a programme at min. 75 °C or the "Clean machine" programme

Cleaning the water inlet filter

The washing machine has 2 filters to protect the inlet valve. Check these filters every 6 months or so. Perform this check more often if there are frequent interruptions to the external water supply.

Cleaning the filter in the inlet hose

- First turn off the stopcock.
- Unscrew the inlet hose from the stopcock.

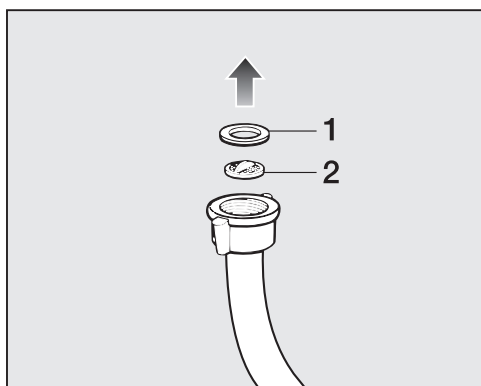

- Remove the rubber seal **1** from the recess.

- Using pointed pliers, take hold of the plastic filter slat **2** and remove the plastic filter.
- Clean the filter.
- Reassemble in reverse order.

Cleaning the filter in the inlet valve

- Using pliers, carefully loosen the ribbed plastic nut on the inlet valve and unscrew it.

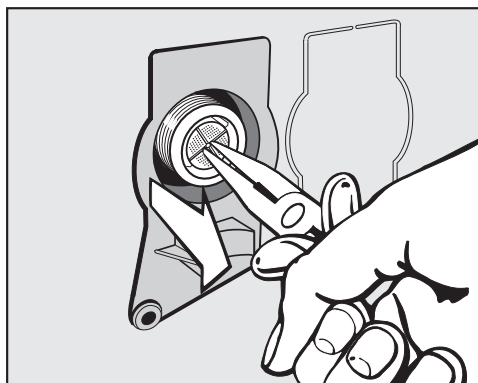

- Use pointed pliers to withdraw the plastic filter by the slat.
- Clean the filter.
- Reassemble in reverse order.

The two filters must be put back in place after cleaning.

- Screw the screw connection securely back onto the stopcock.
- Open the stopcock.

Make sure there is no water leaking from the threaded union.
Tighten the threaded union.



Problem solving guide

Many malfunctions and faults that can occur in daily operation can be easily remedied. Time and money will be saved because a service call will not be needed.

The following guide may help you to find the reason for a malfunction or a fault, and to correct it.









Some of the messages in the display are more than one line long. Touch the ∨ or ∧ sensor to read them in full.

The programme does not start

Problem	Cause and remedy
The control panel remains dark.	There is no power to the machine. <ul style="list-style-type: none">■ Check whether the mains plug is plugged in and switched on.■ Check whether the fuse or circuit breaker has tripped.
	The washing machine has switched off automatically to save energy. <ul style="list-style-type: none">■ Switch the washing machine on again by turning the programme selector.
The display prompts you to enter a code.	Access via a code has been activated. <ul style="list-style-type: none">■ Enter the code and confirm the entry. Deactivate the code if you do not wish this message to appear in the display the next time the machine is switched on.
The following appears in the display:   Service Door release fault F35	The door is not closed properly. The door lock could not engage. <ul style="list-style-type: none">■ Close the door again.■ Start the programme again. If the fault message appears again, contact the Miele Customer Service Department.

Problem solving guide

Fault message after a programme has been interrupted.

Problem	Cause and remedy
 Drainage See 	<p>The drain is blocked or restricted. The drain hose has been fixed too high.</p> <ul style="list-style-type: none"> ■ Clean the drain filter and the drain pump. ■ The maximum drain height is 1 m.
 Water intake See 	<p>The water inlet is blocked or restricted.</p> <ul style="list-style-type: none"> ■ Check whether the stopcock has been properly opened. ■ Check whether the inlet hose is kinked. ■ Check whether there is sufficient water pressure. <p>The filter in the water inlet is blocked.</p> <ul style="list-style-type: none"> ■ Clean the filter. <p>The drain pump is activated for 2 minutes. The washing machine door is then released. Wait for the drain pump to stop before switching the washing machine off.</p>
 Waterproof system. Turn off   Service	<p>The water protection system has reacted.</p> <ul style="list-style-type: none"> ■ Close the stopcock. ■ Call the Miele Customer Service Department.
  Service Fault F	<p>There is a fault.</p> <ul style="list-style-type: none"> ■ Disconnect the washing machine from the electricity supply. Switch off at the wall and withdraw the plug from the socket, or disconnect the fuse. ■ Wait at least 2 minutes before reconnecting the washing machine to the electricity supply. ■ Switch the washing machine on again. ■ Restart the programme. <p>If the fault message appears again, contact the Miele Customer Service Department.</p>

To switch off the fault message: Turn the programme selector to the  position and switch the washing machine off.

Fault message at the end of a programme

Problem	Cause and remedy
<p>i Check dosage</p>	<p>Excessive foam has built up during washing.</p> <ul style="list-style-type: none"> ■ With TwinDos, check the dosage amount set. ■ Reduce the amount set in 10 % increments. ■ Use less detergent next time and follow the manufacturer's instructions on dosage given on the packaging.
<p>i Hygiene info: run a programme at min. 75 °C or the "Clean machine" programme</p>	<p>When washing, a wash programme using a temperature above 60 °C has not been run for a long time.</p> <ul style="list-style-type: none"> ■ Turn the programme selector to <i>Further programmes</i>/. ■ Touch the \wedge/\vee sensor controls until Maintenance appears in the display. ■ Touch the <i>OK</i> sensor control. <p>The following appears in the display: Clean machine</p> <ul style="list-style-type: none"> ■ Touch the <i>OK</i> sensor control. ■ Run the Clean machine programme using Miele machine cleaner or a universal powder detergent. <p>This will clean the washing machine and prevent a build-up of bacteria and odours.</p>

The messages will appear at the end of the programme and when the washing machine is switched on and need to be confirmed with the *OK* sensor control.



Problem solving guide

Fault message at the end of a programme

Problem	Cause and remedy
i Align the washing machine	<p>The <i>Pre-ironing</i> extra option which runs at the end of the programme could not be carried out properly.</p> <ul style="list-style-type: none">■ Check whether the washing machine is aligned correctly (see “Installation – Levelling the machine”).■ Check whether the maximum drain height of 1 m has been exceeded. <p>If the fault message appears again, contact the Miele Customer Service Department. The washing machine can still be used, but without the <i>Pre-ironing</i> extra option.</p>
i Check filter + jet	<p>The pumps are soiled.</p> <ul style="list-style-type: none">■ Clean the pumps as described in “Problem solving guide – Opening the door in the event of a blocked drain outlet and/or power failure”.■ Restart the programme after cleaning. <p>The nozzle in the top of the door ring is blocked with fluff.</p> <ul style="list-style-type: none">■ Remove the fluff with your finger. Do not use any sharp or pointed tools to do this.■ Restart the programme after cleaning. <p>If the fault message appears again, contact the Miele Customer Service Department. The washing machine can still be used but with reduced functionality.</p>

The messages will appear at the end of the programme and when the washing machine is switched on and need to be confirmed with the *OK* sensor control.

Messages or faults with the TwinDos system

Problem	Cause and remedy
<p>i ① is almost empty. Only a few more programmes are possible</p>	<p>The detergent in the cartridge is running low. There is sufficient left for approx. 4 to 8 wash programmes.</p> <ul style="list-style-type: none"> ■ Order a new cartridge.
<p>i TwinDos ① is empty. Check wash results</p>	<p>The cartridge is empty.</p> <ul style="list-style-type: none"> ■ Replace the cartridge. ■ Check if the laundry is clean. There may not have been enough detergent. If there was not enough detergent, wash the laundry again.
<p>i Use “TwinDos” or start Maintenance. See </p>	<p>TwinDos dispensing via compartment ① and/or ② has not been used for a long time.</p> <ul style="list-style-type: none"> ■ Use TwinDos for one of your next loads. ■ Carry out the TwinDos maintenance programme as described in “Cleaning and care – TwinDos maintenance”.
<p> TwinDos Maintenance for compartment ① and compartment ② must be started. See </p>	<p>TwinDos dispensing via compartment ① and/or ② has not been used for too long a time. It is possible that detergent has dried inside the hoses.</p> <ul style="list-style-type: none"> ■ Immediately carry out the TwinDos maintenance programme as described in “Cleaning and care – TwinDos maintenance”.

The messages shown on this page are examples. They may differ depending on whether they refer to compartment ① or ②.

Problem solving guide

Messages or faults with the TwinDos system



Problem	Cause and remedy
No detergent was dispensed during the main wash.	<p>TwinDos is deactivated.</p> <ul style="list-style-type: none">■ Before the next wash programme, ensure that the <i>TwinDos</i> sensor control is lit. <p>Detergent is not dispensed even though the <i>TwinDos</i> sensor control is lit.</p> <ul style="list-style-type: none">■ Give it another try.■ If detergent is still not dispensed, call the Miele Customer Service Department.
A new detergent cartridge has been inserted, but the cartridge is identified as empty when the machine is switched on.	<p>The washing machine was switched off when the detergent cartridge was replaced.</p> <ul style="list-style-type: none">■ Switch on the washing machine.■ Remove the detergent cartridge and then reinsert it into the compartment. <p>The counter is set to 0.</p>

General problems with the washing machine

Problem	Cause and remedy
<p>The washing machine smells.</p>	<p>Hygiene info was ignored. When washing, a wash programme using a temperature above 60 °C has not been run for a long time.</p> <ul style="list-style-type: none"> ■ Run the <i>Clean machine</i> programme using Miele machine cleaner or a universal powder detergent. <p>This will clean the washing machine and prevent a build-up of bacteria and odours.</p> <hr/> <p>The door and the detergent drawer were left closed after washing.</p> <ul style="list-style-type: none"> ■ Leave the door and the detergent drawer slightly open to allow them to dry.
<p>The machine shakes during the spin cycle.</p>	<p>The machine feet are not level.</p> <ul style="list-style-type: none"> ■ Level the machine and adjust the feet correctly.
<p>The laundry has not been spun properly and is still wet.</p>	<p>The machine detected an imbalance during the final spin cycle and reduced the spin speed automatically.</p> <ul style="list-style-type: none"> ■ Include both large and small items in the load as this will give better distribution during spinning.
<p>Strange pump noises can be heard.</p>	<p>This is not a fault.</p> <p>These slurping noises occur at the end of the pump sequence as a normal part of operation.</p>
<p>The display is in a different language.</p>	<p>A different language has been selected in “Settings, Language  ■ Set the language you want. The flag symbol will guide you. </p>

Problem solving guide

General problems with the washing machine



Problem	Cause and remedy
Large amounts of detergent residue remain in the detergent dispenser drawer.	The water pressure is too low. <ul style="list-style-type: none">■ Clean the water inlet filter.■ It may be useful to select the <i>Water</i> + extra option.
	Powder detergent used in conjunction with water softeners tends to become sticky. <ul style="list-style-type: none">■ In future, add washing powder into the dispenser drawer first, and then add the water softener.
Fabric conditioner is not completely dispensed or too much water remains in the  compartment.	The siphon tube is not correctly positioned or is clogged. <ul style="list-style-type: none">■ Clean the siphon, see “Cleaning and care - Cleaning the detergent dispenser drawer”.
At the end of the programme there is still liquid in the capsule.	The small pipe in the detergent dispenser drawer onto which the capsule is placed is blocked. <ul style="list-style-type: none">■ Clean the small pipe.
	This is not a fault. For technical reasons a small amount of water will remain in the capsule.
There is water in the fabric conditioner compartment next to the capsule.	The  sensor control was not activated. <ul style="list-style-type: none">■ Activate the  sensor control when a capsule is next used.
	An empty capsule was not removed at the end of the last wash programme. <ul style="list-style-type: none">■ Remove and dispose of the empty capsule at the end of each programme.
	There is a blockage in the small pipe in the detergent drawer onto which the capsule is placed. <ul style="list-style-type: none">■ Clean the small pipe.

An unsatisfactory wash result

Problem	Cause and remedy
Liquid detergent does not give the required result.	<p>Liquid detergents usually contain no bleaching agents. They do not remove fruit, coffee and tea stains.</p> <ul style="list-style-type: none">■ Use the Miele 2 Phase System. The targeted addition of UltraPhase 2 during the wash process removes stains effectively.■ Use a general purpose powder detergent containing a bleaching agent.
Grey, greasy particles cling to washed laundry.	<p>Insufficient amounts of detergent were used to break down the particles of grease in heavily soiled laundry.</p> <ul style="list-style-type: none">■ Use more detergent.■ Before washing the next load, run the <i>Clean machine</i> using Miele machine cleaner or a powder detergent.
White residues which look like powder detergent are seen on dark textiles after washing.	<p>The detergent contained compounds (zeolites) to aid water softening which are not soluble in water. These have ended up on the laundry.</p> <ul style="list-style-type: none">■ Try and brush off the residues with a soft brush once the laundry is dry.■ Wash dark textiles using a detergent which contains no zeolites. Liquid detergents usually contain no zeolites.■ Use the <i>Dark garments/Denim</i> programme for dark coloured laundry.

Problem solving guide

The door will not open

Problem	Cause and remedy
The door cannot be pulled open during a wash cycle.	The drum is locked during the wash cycle. ■ Follow the description in “6. Starting a programme – Adding or removing laundry”.
Comfort cooling appears in the display after a programme has been cancelled.	To protect the user against scalding, the door cannot be opened if the suds temperature is higher than 55 °C. ■ Wait until the temperature in the drum has decreased and the message has gone out in the display.
The following appears in the display:   Service Door release fault F35	The door lock has jammed. ■ Call the Miele Customer Service Department.

Opening the door in the event of a blocked drain outlet and/or power cut

- Switch off the washing machine.

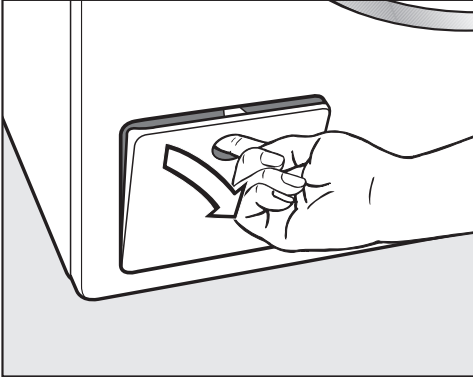

- Open the access panel for the drain pump.

Blocked drain outlet

If the drain outlet is blocked, there may be a large quantity of water left behind in the washing machine.

 Risk of scalding due to hot suds. Escaping suds will be hot if laundry has been washed at high temperatures! Carefully allow all suds to drain off.

Draining the washing machine

Remove the drain filter, though not completely.

- Place a suitable container under the access panel, e.g. a universal oven tray.

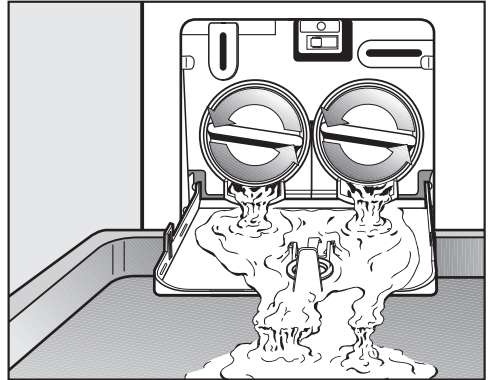

- Slowly unscrew the drain filters to let the water out.
- Tighten the drain filters back up again if you need to interrupt the flow of water.

Once the flow of water ceases:

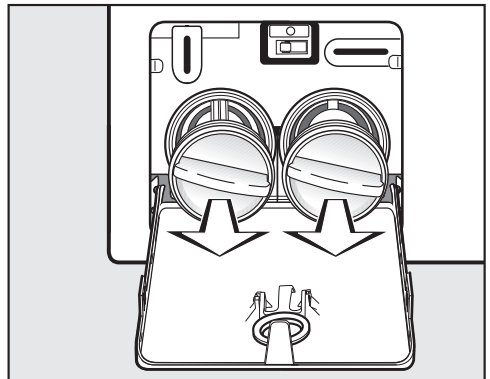

- Remove the drain filters completely.

Problem solving guide

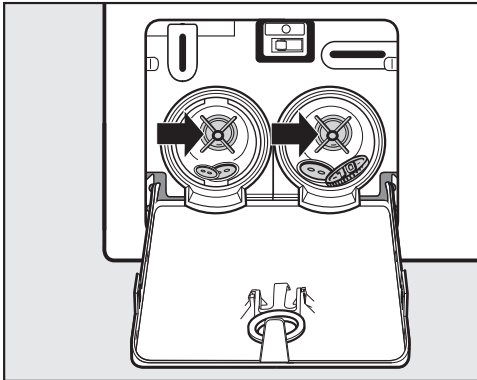

- Clean the drain filters thoroughly.
- Remove any foreign objects (e.g. buttons, coins, etc.) and clean the interior. Turn the impellers by hand to check that they rotate freely.

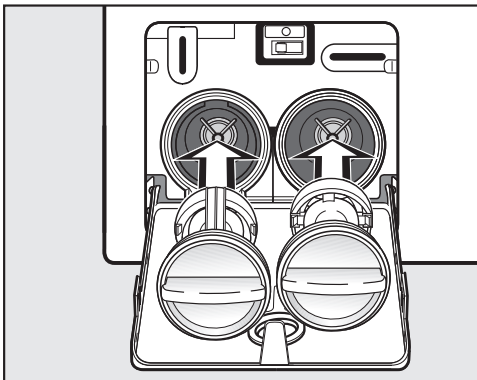

- Replace the drain filters correctly (on the right and left) and tighten them securely.
- Close the drain pump access panel.

⚠ Risk of water damage.

Make sure the drain filters are securely tightened. Otherwise there is a risk of water leakage during use. Replace the drain filters correctly and tighten them securely.

Open the door

⚠ Danger of injury due to rotating drum!

Reaching into a moving drum is extremely dangerous.

Always make sure that the drum is stationary before reaching in to remove laundry.

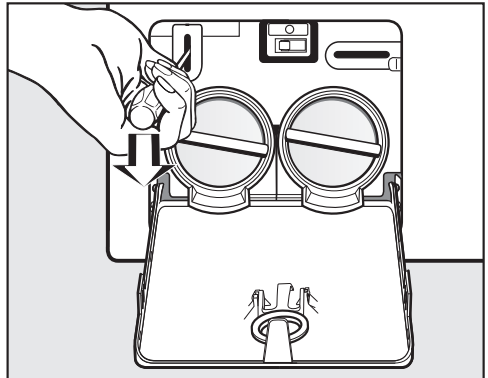

- Use a screwdriver to unlock the door.
- Pull open the door.

Contact in the event of a fault

In the event of any faults which you cannot remedy yourself, please contact your Miele dealer or the Miele Customer Service Department.

You can book a Miele Customer Service Department call-out online at www.miele.com/service.

Contact information for the Miele Customer Service Department can be found at the end of this document.

Please quote the model identifier and serial number of your appliance (Fabr./SN/Nr.) when contacting the Miele Customer Service Department. This information can be found on the data plate.

Please note that telephone calls may be monitored and recorded for training purposes and that a call-out charge will be applied to service visits where the problem could have been resolved as described in this booklet.

The data plate is found above the porthole glass when the door is opened.

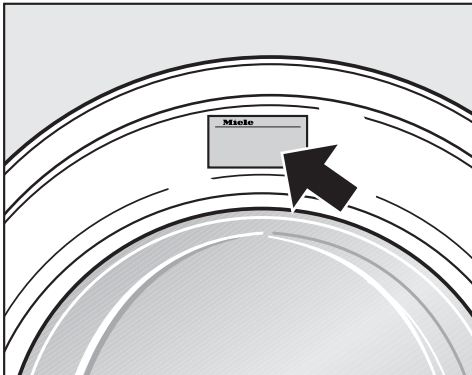

Optional accessories

Optional spare parts and accessories for this washing machine are available from your Miele Dealer, the Miele Spare Parts Department or via the internet at www.miele.co.uk.

Please note that telephone calls may be monitored and recorded for training purposes.

Guarantee

For information on the appliance guarantee specific to your country please contact Miele. See end of this booklet for contact details.

Installation

Front view

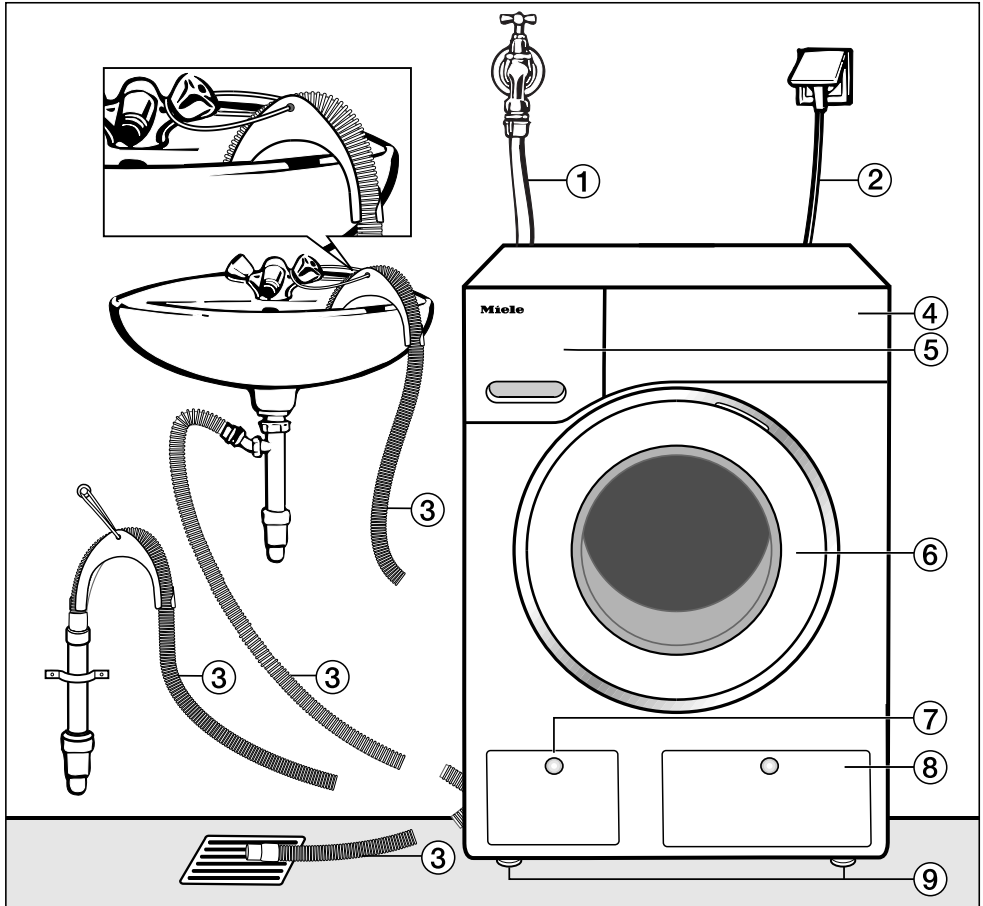

- ① Water inlet hose (pressure tested to 7000 kPa)
- ② Mains connection cable
- ③ Flexible drain hose (with detachable swivel elbow)
- ④ Control panel

- ⑤ Detergent dispenser drawer
- ⑥ Door
- ⑦ Access to filters, pumps and emergency release
- ⑧ Access panel for TwinDos cartridges
- ⑨ Four height-adjustable feet

Rear view

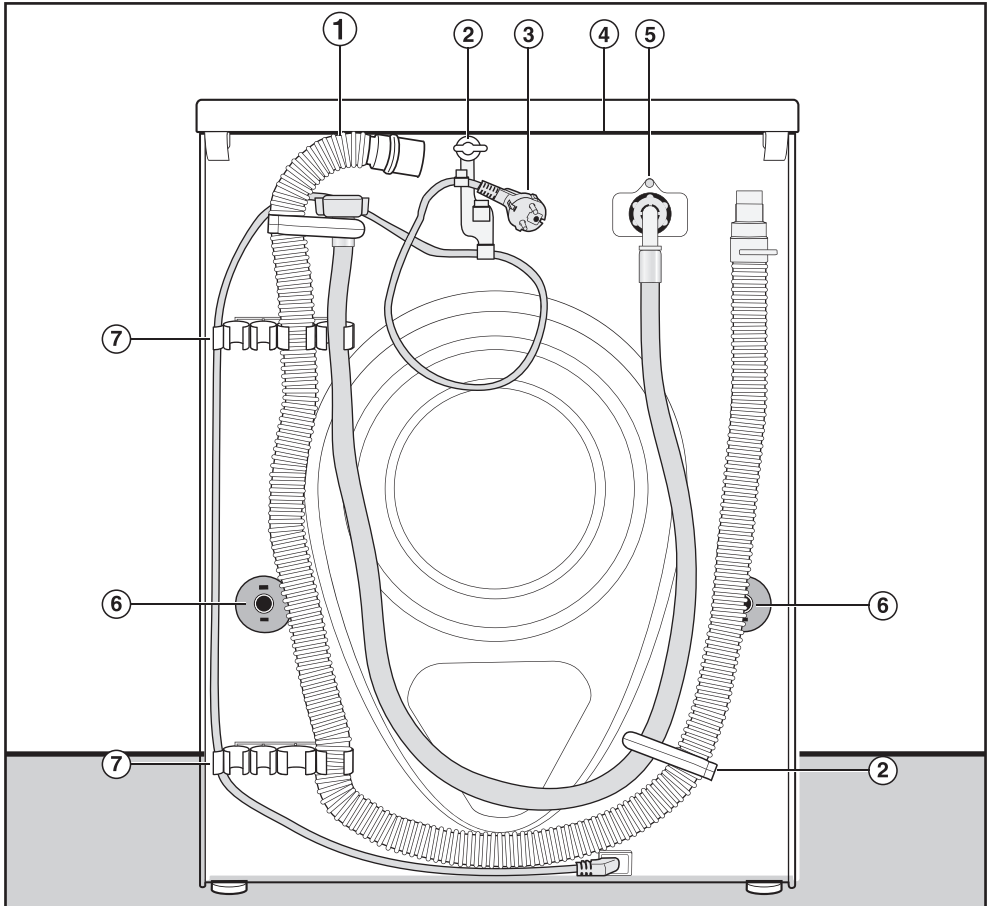

- ① Drain hose
- ② Transport clips for inlet and drain hoses and mains connection cable
- ③ Mains connection cable
- ④ Protruding lid for holding when moving the machine
- ⑤ Water inlet hose (pressure tested to 7000 kPa)
- ⑥ Safety caps for transit bars
- ⑦ Transport clips for inlet and drain hoses and for storing transit bars when not in use

Installation

Installation surface

A concrete floor is the most suitable installation surface. It is far less prone to vibration during the spin cycle than wooden floorboards or a carpeted surface.

Please note:

- The machine must be level and securely positioned.
- To avoid vibrations during spinning, the machine should not be installed on soft floor coverings.

If installing on a wooden joist floor:

- Install the machine on a plywood base (at least 59 x 52 x 3 cm). The base should span several joists and be bolted to the joists and not only to the floorboards. Check for the presence of pipes and cables first.

Tip: If possible, install the machine in a corner. This is usually the most stable part of the floor.

 Injury can occur if the washing machine has not been adequately secured.

During installation, the washing machine must be secured on a plinth to be made available on site (concrete or brick), in order to ensure it cannot fall or slip.

Secure the washing machine using a clamp/fastening bracket (MTS floor mounting kit – available from your Miele dealer or Miele spare parts department).

Transporting the washing machine to its installation site

 Danger of injury due to unsecure lid.

Make sure the fixings at the back of the lid are secure. Otherwise there is a danger of the lid being pulled off when carrying the machine.

Before carrying the machine check that the lid is secure where it protrudes at the back of the machine.

- Carry the washing machine by the front feet and by the lid where it protrudes at the back of the appliance.

Removing the transit bars

Removing the left-hand transit bar

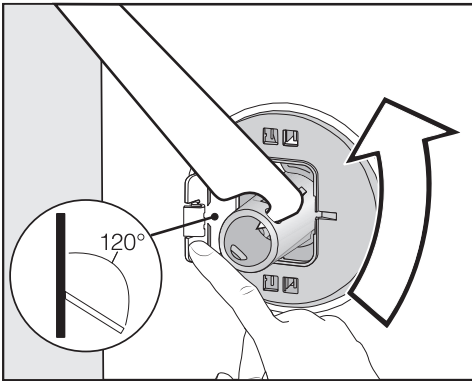

- Push the cover out and turn the left-hand transit bar 90° using the spanner supplied.

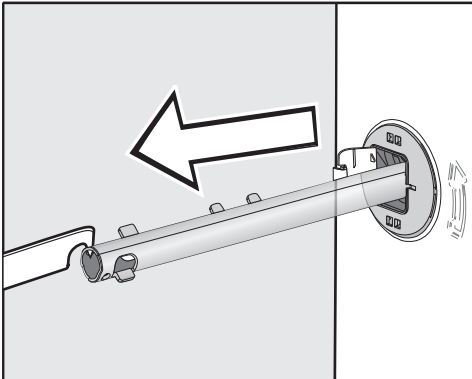

- Withdraw the transit bar.

Removing the right-hand transit bar

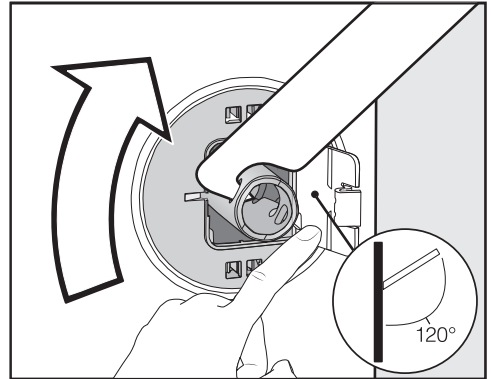

- Push the cover out and turn the left-hand transit bar 90° using the spanner supplied.

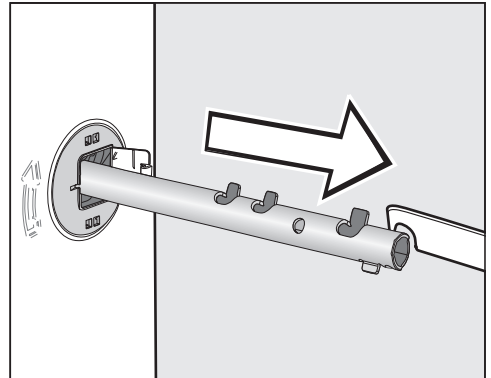

- Withdraw the transit bar.

Installation

Covering holes

 Risk of injury from sharp edges. There is a risk of injury from reaching into holes that are not covered. Cover the holes for the transit bars after they have been removed.

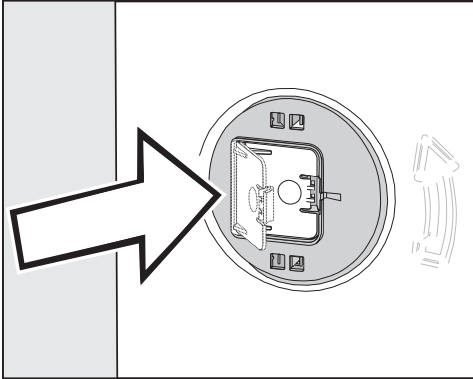

- Push the covers in firmly until they engage in position.

Securing the transit bars

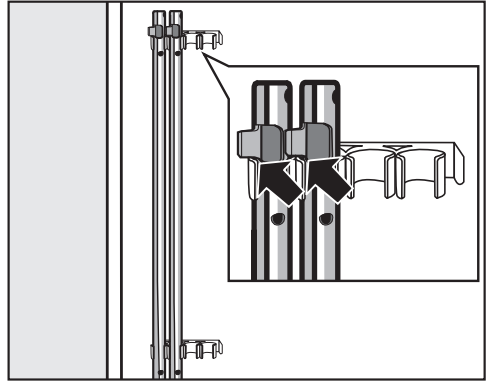

- Secure the transit bars to the back of the washing machine. Make sure that the top catch is located above the holder.

 Risk of damage from incorrect transport.

The washing machine may become damaged if moved without the transit bars in place.

Keep the transit bars in a safe place. Fit them again if the machine is to be moved (e.g. when moving house).

Fitting the transit bars

Opening the covers



- Press against the retainer with a sharp object (a narrow screwdriver, for example).

The cover opens.

Fitting the transit bars

- To fit the bars, follow the instructions for removing them in reverse order.

Tip: The bars will slide in more easily if you lift the drum slightly.

Installation

Levelling the machine

The washing machine must stand perfectly level on all four feet to ensure safe and proper operation.

Incorrect installation may increase electricity and water consumption and may cause the machine to move about.

Screwing out and adjusting the feet

The four adjustable screw feet are used for levelling the washing machine. The machine is supplied with all four feet are screwed in.

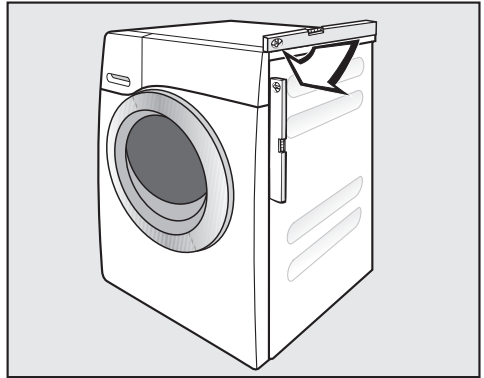

- Use a level to check that the washing machine is standing level.
- Hold foot **1** securely with a pipe wrench. Turn counter nut **2** again using the spanner supplied until it sits firmly up against the housing.

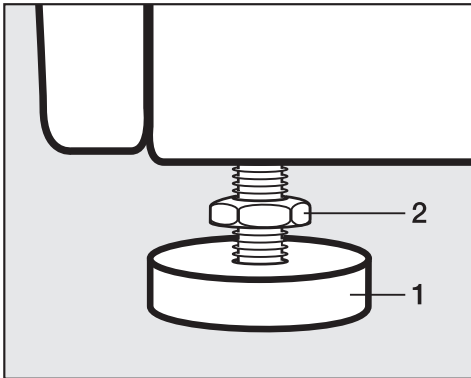

- Using the spanner supplied, turn counter nut **2** in a clockwise direction. Then turn counter nut **2** together with foot **1** to unscrew.

 Risk of damage due to incorrectly aligned washing machine.

There is a danger of the washing machine moving about if the feet are not secured.

Turn all four counter nuts for the feet until they sit firmly up against the housing. Please also check this for the feet which did not need adjustment.

Installing under a continuous worktop

 Risk of electric shock due to exposed cables

There is a risk of coming into contact with live parts while the lid is removed.

Do not remove the washing machine lid.

This washing machine (with lid intact) can be pushed under a countertop if there is space to do so.

Washer-dryer stack

The washing machine can be combined with a Miele tumble dryer in a washer-dryer stack. The appropriate “WTV” stacking kit* to match your dryer is required.

All parts marked* are available from your Dealer or Miele.

Please note:

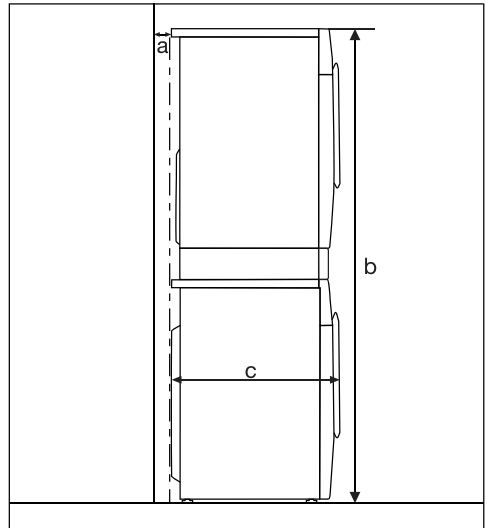

a = at least 2 cm

b = WTV without drawer: 172 cm
WTV with drawer: 181 cm

c = 65 cm

Installation

The water protection system

The Miele water protection system protects all parts of the washing machine from water damage.

The system consists of three main components:

- the inlet hose
- the electronic unit and drainage and overflow protection
- the drain hose

Inlet hose

- Protection against bursting

The inlet hose is tested to withstand pressure of at least 7,000 kPa.

Electronic module and housing

- Floor tray: any leaking water from the washing machine is collected in the floor tray. There is a float switch to close the water intake valve. The water inlet is shut off and any water inside the suds container is drained away.
- Leak protection: any leaking water that is not collected in the floor tray is detected. The water inlet is shut off and any water inside the suds container is drained away.
- Overflow protection: this prevents the washing machine from taking in too much water and overflowing. If the water level exceeds a certain level, the drain pump switches on and pumps the excess water away.

Drain hose

The drain hose is protected by a ventilation system which prevents the washing machine from being emptied completely.

Connection to the water supply

Connecting the water inlet

 Health risk and risk of damage due to contaminated incoming water. The quality of the incoming water must correspond to the drinking water specification of the country in which the washing machine is being operated. Always connect the washing machine to the mains water supply.

The water connection pressure needs to be between 100 and 1000 kPa. If the water connection pressure exceeds 1000 kPa, a pressure reducing valve must be installed.

A stopcock with a $\frac{3}{4}$ inch threaded union is required for the connection. If this is not available, only a qualified installer may connect the washing machine to the mains water supply.

The screw thread is subject to water connection pressure. Check the connection for leaks. Slowly open the stopcock. Correct the position of the seal and screw thread if necessary.

The washing machine is not suitable for connection to a hot water supply. The washing machine must not be connected to a hot water supply.

Maintenance

Only use a genuine Miele hose that has been pressure tested to withstand at least 7,000 kPa should you ever need a replacement.



Damage caused by dirty water.

A filter is located in the open end of the inlet hose and another in the intake point to protect the inlet valve in the washing machine.

These filters must not be removed.

Hose extension

Longer hoses 2.5 or 4.0 m in length are available from your Miele Dealer or Miele as optional extras.

Installation

Water drainage

The suds are drained through a drain pump with a 1 m high delivery head. For the water to drain freely, the hose must be free of kinks.

If required, the hose can be extended to a length of up to 5 m. Accessories are available from your Miele dealer or from the Miele Customer Service Department.

For drain heights of more than 1 m (up to a maximum delivery head of 1.8 m), a replacement drain pump will need to be fitted. Please contact Miele for advice. For a drain height of 1.8 m, the hose can be extended to a length of up to 2.5 m. Accessories are available from your Miele dealer or from the Miele Customer Service Department.

Drainage options:

1. Directed into a sink or basin:

Please note:

- Hook the hose over the edge and secure it.
- If the water is pumped into a washbasin, make sure that it can drain away freely. Otherwise there is a risk of water overflowing or of some of the drained water being sucked back into the machine.

2. Connected securely to a plastic drain pipe with a rubber nipple (there is no need to use a siphon).

3. Connected securely to a floor drain (gully).

4. Connected securely to a washbasin with plastic nipple.

Fitting the elbow

Use the elbow supplied to stop the drain hose from slipping.

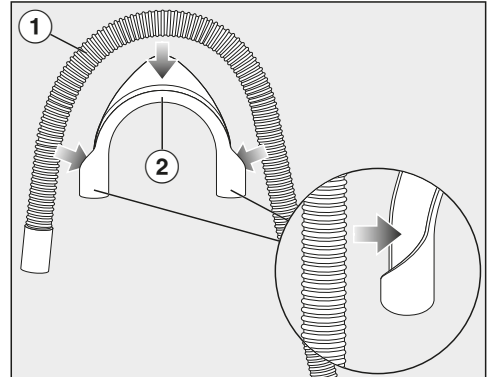

- Attach the elbow ② to the drain hose ①.

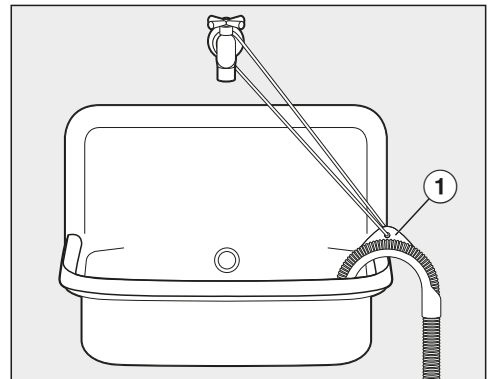

- Place the end of the drain hose in a sink.
- Use a strap and the eye ① to stop the elbow from slipping.

Direct connection to a sink drain outlet

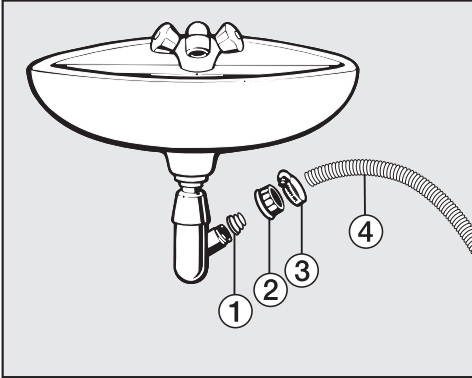

- ① Adapter
- ② Spigot nut
- ③ Hose clip
- ④ End of the hose

- Fit adapter ① to the sink drain outlet using nut ②.
- Attach the end of hose ④ to adapter ①.
- Use a screwdriver to tighten hose clip ③ up close to the nut.

Installation

Electrical connection

The washing machine is supplied with an electrical connection cable with a moulded plug ready for connection to a switched socket.

The socket must be easily accessible after the washing machine has been installed. If that is not possible, ensure that a suitable means of disconnection is provided on the installation side for each pole.



Risk of fire from overheating.

Connecting the washing machine to a multi-socket plug adapter or to an extension lead can overload the cable.

Do not use an extension lead or multi-socket plug adapter.

The electrical system must comply with local and national safety regulations (BS 7671 in the UK). We recommend the use of a suitable RCD .



If the connection cable is damaged, it must only be replaced with a specific connection cable of the same type (available from the Miele Customer Service Department). For safety reasons, such replacement may only be carried out by a qualified technician or the Miele Customer Service Department.

The data plate indicates the nominal power consumption and the appropriate fuse rating. Compare the specifications on the data plate with those of the electricity supply and make sure that they match.

If in any doubt, consult a qualified electrician.

Temporary or permanent operation on an autonomous power supply system or a power supply system that is not synchronised with the mains power supply (e.g. island networks, back-up systems) is possible. A prerequisite for operation is that the power supply system complies with the specifications of EN 50160 or an equivalent standard. The function and operation of the protective measures provided in the domestic electrical installation and in this Miele product must also be maintained in isolated operation or in operation that is not synchronised with the mains power supply, or these measures must be replaced by equivalent measures in the installation. As described, for example, in the current version of BS OHSAS 18001–2 ISO 45001.

Consumption data

	°C	Load kg	Energy kWh	Water Litres	Duration h:min	Residual moisture %
ECO 40-60		9.0	0.90	65	3:19	42
Cottons	60 °C	9.0	1.45	65	2:29	50
	 *	9.0	0.74	54	2:59	44
	20 °C	9.0	0.40	75	2:39	46
Minimum iron	30 °C	4.0	0.34	52	1:59	30
Express 20 ¹⁾	40 °C	3.5	0.33	30	0:20	–
Woolens 	30 °C	2.0	0.23	35	0:39	–
QuickPowerWash	40 °C	4.0	0.58	40	0:49	–

1) Quick Extra activated

Consumption data can vary from the nominal values given depending on water pressure, water hardness, water inlet temperature, room temperature, type and volume of load, fluctuations in the electricity supply and any extras selected.

The consumption data shown in the Feedback display can vary from the consumption data quoted here. The variations arise from component tolerances and on-site conditions e.g. fluctuations in the pressure of the water supply, mains voltage and fluctuations in the mains voltage.

Note for test institutes

*Test programme in accordance with IEC 60456 or EN 60456.

TwinDos dispensing must be deactivated when carrying out comparison tests.

With the *PowerWash* washing technique, during the heating phase, the temperature measured by the sensor in the suds container is higher than the actual temperature of the laundry.

The temperature measured at the sensor **does not** reflect the temperature of the laundry.

Technical data

Height	850 mm
Width	596 mm
Depth	643 mm
Depth with door open	1077 mm
Height for building under	850 mm
Width for building under	600 mm
Weight	Approx. 90 kg
Capacity	9.0 kg dry laundry
Supply voltage	See data plate
Rated load	See data plate
Fuse rating	See data plate
Consumption data	See “Consumption data”
Minimum water flow pressure	100 kPa (1 bar)
Maximum water flow pressure	1000 kPa (10 bar)
Water inlet hose length	1.60 m
Drain hose length	1.50 m
Length of mains connection cable	2.00 m
Maximum delivery head	1.00 m
Maximum drainage length	5.00 m
LEDs	Class 1
Test certifications awarded	See data plate
Power rating in off mode	0.40 W
Networked standby	0.80 W
Frequency range	2.4000–2.4835 GHz
Maximum transmission power	< 100 mW

You can use the settings to alter the washing machine's electronics to suit changing requirements.

The settings can be altered at any time.

Accessing the Settings menu

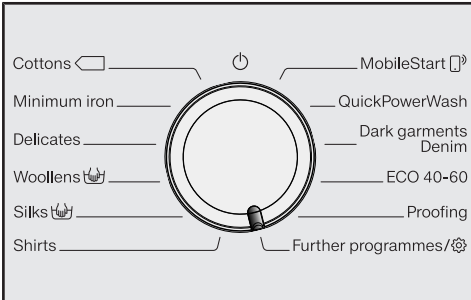

- Turn the programme selector to the *Further programmes* position.



- Touch the ∇/Δ sensor controls until the following appears in the display:



- Confirm with the *OK* sensor control.



You are now in the *Settings* sub-menu.

Selecting settings

- Touch the ∇/Δ sensor controls until the setting you want appears in the display.
 - The ∇ sensor control scrolls down the list.
 - The Δ sensor control scrolls up the list.
- Touch the *OK* sensor control to select the setting displayed.

Changing a setting

- Touching the ∇/Δ sensor controls will call up the different options for the setting.

The option that is selected will have a tick \checkmark next to it.

- Touch the *OK* sensor control to activate the option you want in the display.

Closing the settings menu

- Turn the programme selector.

Settings

Language

The display can be set to appear in one of several different languages.

The  flag after the word Language acts as a guide in case a language which is not understood has been set.

The language selected is saved.

TwinDos

You can set the type of detergent and dispensing quantities and check the fill level of the UltraPhase 1 and UltraPhase 2 cartridges.

Change dosage

The values set for dispensing detergent from compartments ① and ② can be checked and corrected.

Check level

This function is only available when UltraPhase 1 and 2 are being used.

The fill level is displayed in a bar chart.

The display only works correctly when the following conditions are met:

1. New (full) cartridges are used.
2. The cartridges must not be removed from the washing machine before they need replacing.

Select detergent

If you wish to use your own detergent with the TwinDos function instead of UltraPhase 1 and 2, you will need to purchase the TwinDos refill cartridge separately (optional accessory).

UltraPhase 1 and 2 can only be dispensed as a package. If a different agent is selected, the setting for the other compartment is automatically deleted.

The following agents can be used:

- Universal
- Delicates
- Delicates/Woolens
- Fabric conditioner
- No agent

Follow the manufacturer's instructions on dosage given on the packaging.

- The dispensing quantity required for the agent being used must be set. Follow the instructions in the display on how to do so.

Tip: If you select No agent the respective TwinDos compartment will be deactivated.

Degree of soiling

You can specify the degree of soiling that is preset for the  sensor control.

Options:

- Light
- Normal (factory default)
- Heavy

Buzzer volume

The buzzer sounds to let you know the programme has finished. The buzzer can be set to be louder or quieter.

Selection

- Off
- ■■■■■■■■ (quiet)
- ■■■■■■■■ (loud) (factory default)

Keypad tone

Each touch of a sensor control is confirmed with an audible tone.

Selection

- Off
- ■■■■■■■■ (quiet)
- ■■■■■■■■ (factory default)
- ■■■■■■■■ (loud)

Welcome tone

The volume for the welcome tone can be set to one of 7 different settings.

Selection

- Off
- ■■■■■■■■ (quiet)
- ■■■■■■■■ (factory default)
- ■■■■■■■■ (loud)

Consumption

In this setting you can check the saved energy and water consumption values.

Selection

- Previous programme
Shows the consumption for the last wash programme carried out.
- Total consumption
Shows the sum of the energy and the sum of the water used by the previous programmes.
- Reset function
The energy consumption and water consumption totals are reset to zero.

Settings

Code

The PIN code prevents the washing machine being used without your knowledge.

Selection

- Activate
If you activate the PIN code, you have to enter a PIN code after switching the washing machine on. Otherwise it cannot be operated. The factory default PIN code is 125.
- Change
If wished, you can set a different three-digit PIN code.

 Do not forget the code you have set.

If you forget the code, only Miele Technical Service can unlock the washing machine.

Make a note of your new code.

- Deactivate
The washing machine is to be operated again without entering a PIN code. This only appears if the PIN code had been activated previously.

Units

The temperature can be displayed as degrees °C/Celsius or °F/Fahrenheit.

The factory default is °C/Celsius.

Brightness

You can set the brightness of the display, the sensor controls and the dimmed sensor controls.

Selection

- Display
Controls the brightness of the display.
 - ■ □ □ □ □ □ □ □ (dark)
 - ■ ■ ■ ■ ■ ■ ■ ■ (light) (factory default)
- Buttons active
Controls the brightness of the activated sensor controls.
 - ■ □ □ □ □ □ □ □ (dark)
 - ■ ■ ■ ■ □ □ □ □ (factory default)
 - ■ ■ ■ ■ ■ ■ ■ ■ (light)
- Buttons inactive
Controls the brightness of the sensor controls that can be activated.
 - ■ □ □ □ □ □ □ □ (dark)
 - ■ ■ ■ ■ □ □ □ □ (factory default)
 - ■ ■ ■ ■ ■ ■ ■ ■ (light)

Tip: Ensure that there is a discernible difference in brightness between the activated and dimmed sensor controls. A big difference in brightness makes it easier to operate the appliance.

Disp. switch-off stat.

The display and the sensor control lighting is switched off to save energy. The Start/Add laundry sensor control flashes slowly.

Selection

- On (factory default)
The lighting switches off after 10 minutes.
- On (not current pr.)
The lighting remains switched on throughout the programme. The lighting switches off 10 minutes after the programme has ended.
- Off
The lighting remains switched on.

Programme info

You can select the information that will be displayed temporarily in the display after a programme has been selected.

Selection

- Programme name
The programme name is shown in the display for several seconds.
- Prog. & max load (factory default)
The programme name and the maximum load size are shown in the display for several seconds.
- Off
Directly after the programme has been selected, the standard display is shown with temperature, spin speed and programme duration.

Memory

The washing machine will save the last settings (temperature, spin speed and some of the extras) selected for a programme after the programme has started.

When the programme is chosen again, the saved settings will appear in the display.

Memory is deactivated as standard.

Long p-wash Cotton

If you require a longer pre-wash, you can extend the standard pre-wash time of 25 minutes.

Selection

- No increase (factory default)
25 minute pre-wash.
- + 6 min
31 minute pre-wash.
- + 9 min
34 minute pre-wash.
- + 12 min
37 minute pre-wash.

Settings

Soak duration

You can set a duration for the soak process of between 30 minutes and 6 hours.

The duration can be selected in 30 minute increments. When the *Soak* extra option is selected, the laundry will be soaked for the duration selected.

A duration of 0:30 h is set as standard.

Gentle action

With gentle action activated, drum agitation is reduced. In this way, lightly soiled items can be washed more gently.

Gentle action can be activated for the *Cottons* and the *Minimum iron* programmes.

Gentle action is deactivated as standard.

Temp. reduction

At high altitudes, water has a lower boiling point. Miele recommends activating the reduced temperature setting at altitudes of 2000 m or above to prevent water from boiling. The maximum temperature is reduced to 80 °C even if a higher temperature is selected.

The reduced temperature setting is deactivated as standard.

Water plus

You can select which function is incorporated into the *Water + extra* option.

Selection

- Extra water (factory default)
The water level is increased in the wash and rinse stages of the programme
- Extra rinse
An additional rinse cycle is carried out
- Extra water + rinse
The water level is increased in the wash and rinse stages and an additional rinse is carried out

Water plus level

There are 4 different water levels which can be selected for the *Water + extra* option.

Levels

- Normal (factory default)
- Plus ∆
- Plus ∆∆
- Plus ∆∆∆

Maximum rinse level

This function is important for allergy sufferers as it achieves excellent rinse results.

The water level in the rinses can be permanently set to the highest value. The water consumption will be increased.

The maximum rinse level is deactivated as standard.

Suds cooling

Additional water flows into the drum at the end of the main wash to cool the suds down.

Suds cooling takes place when a *Cottons* programme with a temperature of 70 °C or higher is selected.

Suds cooling must be activated:

- To prevent the danger of scalding if the drain hose is hooked over the edge of a sink or basin
- In buildings where the drainage pipes do not comply with DIN 1986

Suds cooling is deactivated as standard.

Low water pressure

If the water pressure is below 100 kPa (1 bar), the washing machine cancels the programme and the *Water intake* See  fault message appears.

If the on-site water pressure cannot be increased, activating this function will prevent the programme from being cancelled.

Low water pressure is deactivated as standard.

Anti-crease

The anti-crease function reduces creasing after the end of the programme.

At the end of the programme, the drum continues to turn at intervals for up to 30 minutes. The washing machine door can be unlocked at any time by touching the *Start/Add laundry* sensor control and then opened.

Anti-crease is activated as standard.

Settings

Miele@home

Control the networking of your washing machine with your WiFi network.

The following points may appear in the sub-menu:

Set up

This message only appears if the washing machine has not yet been connected to a WiFi network.

Please refer to “Before using for the first time” for instructions on how to set up the connection.

Deactivate (visible if Miele@home is activated)

Miele@home remains set up, the WiFi function is switched off.

Activate (visible if Miele@home is deactivated)

The WiFi function is reactivated.

Connection status (visible if Miele@home is activated)

The following values are displayed:

- The quality of WiFi reception
- The network name
- The IP address

Set up again (visible if set up)

Resets the WiFi login (network) to immediately re-establish a new connection.

Reset (visible if set up)

- The WiFi is switched off.
- The WiFi connection will be reset to the factory default setting.

The network configuration should be reset whenever a washing machine is being disposed of or sold, or if a used washing machine is being put into operation. This is the only way to ensure that all personal data has been removed and the previous owner will no longer be able to access the washing machine.

A new connection setup has to be carried out in order to use the Miele@home setting again.

Remote control

The Remote control setting is only visible if the Miele@home setting is set up and activated.

Once the Miele app has been installed on your mobile device, you can check the status of your washing machine from anywhere and start it remotely. You can also control it remotely via the *MobileStart* programme.

You can switch off the Remote control setting if you do not want to operate the washing machine with your mobile device.

If Remote control is not switched on, the app can cause the programme to be cancelled.

Use the delay start function to set a timeframe within which you want to start the washing machine (see “Delay start/SmartStart”).

The washing machine will then start within the timeframe specified when it receives your signal.

If it has not received a start signal by the latest start time set, the washing machine will start automatically.

Remote control is activated as standard.

SmartGrid

The SmartGrid setting is only visible if the Miele@home setting is set up and activated.

You can set your washing machine to start automatically based on an external signal within a certain time period.

Activating SmartGrid gives the *Delay start* sensor control a new function. Use the delay start control to set the SmartGrid. The washing machine will then start within the time period specified by you when it receives an external signal. If an external signal has not been received by the latest start time set, the washing machine will start automatically (see the “Delay start” chapter).

SmartGrid is deactivated as standard.

Settings

RemoteUpdate

The RemoteUpdate menu option is only displayed and can only be selected if the requirements for using Miele@home have been met (see “Before using for the first time – Miele@home”).

The RemoteUpdate function is used to update the software in your washing machine. If an update is available for your washing machine, it will automatically download it. Updates will not be installed automatically. They must be initiated manually.

If you do not install an update, you can continue to use your washing machine in the usual way. However, Miele recommends installing updates.

Activating/Deactivating

The RemoteUpdate function is activated as standard. Available updates will be downloaded automatically but will only be installed if you initiate installation manually.

Deactivate RemoteUpdate if you do not want any updates to be downloaded automatically.

Running RemoteUpdate

Information about the content and scope of an update will be provided in the Miele app.

A message will appear in your washing machine display if a software update is available.

You can install the update immediately or postpone this until later. When the washing machine is switched on again, you will be reminded about the update.

Deactivate RemoteUpdate if you do not want to install the update.

The update may take several minutes.

Please note the following information about the RemoteUpdate function:

- You will only receive a message when an update is available.
- Once an update has been installed, it cannot be undone.
- Do not switch off the washing machine during an update. Otherwise, the update will be aborted and will not be installed.
- Some software updates can only be carried out by the Miele Customer Service Department.

Copyrights and licences for the communication module

For the purpose of operating and controlling the communication module, Miele uses proprietary or third-party software that is not covered by open source licensing terms. These items of software/software components are protected by copyright. The copyrights held by Miele and third parties must be respected.

Furthermore, this communication module contains software components which are distributed under open source licence conditions. The open source components contained in the appliance along with the corresponding copyright notices, copies of the licensing terms valid at the time, and any further information can be accessed locally via IP using a web browser (*<http://<IP address>/Licenses>*). The liability and warranty arrangements for the open source licences displayed in this location only apply in relation to the respective rights holders.

Detergents and care products

Detergent, fabric care products, additives and machine care products are available for this washing machine. All products have been designed for Miele washing machines.

These and many other products can be ordered from www.shop.miele.com, the Miele Customer Service Department or your Miele dealer.

Detergent

Miele UltraPhase 1 and 2

- 2-component detergent for whites and colours
- For brilliant colours and spotlessly white laundry
- Excellent stain removal even at low temperatures

UltraWhite (powder detergent)

- Best results at 20/30/40/60/95 °C
- Radiant white laundry thanks to powerful formula with active oxygen
- Excellent stain removal even at low temperatures

UltraColor (liquid detergent)

- Best wash results at 20/30/40/60 °C
- With colour-protection formula for brilliant colours
- Excellent stain removal even at low temperatures

WoolCare delicates detergent (liquid detergent)

- For wool, silks and delicates
- Special care complex based on wheat protein and with colour-protection formula
- Best wash results at 20/30/40/60 °C

Specialist detergents

These specialist detergents are available as convenient single-use capsules.

Caps Sport

- For synthetic fabrics
- Neutralises odours thanks to built-in odour absorber
- Prevents static charge in clothes
- Retains the shape and breathability of synthetic fabrics

Caps DownCare

- For down-filled items
- Retains the elasticity and breathability of down
- Lanolin for effective cleaning and gentle care
- Down does not stick together and retains its loft

Caps WoolCare

- Woollens and delicates detergent
- Special wheat-protein-based agents
- Fibre-protection technology to help prevent items shrinking and felting
- Colour-protection formula for gentle cleaning

Caps CottonRepair

- Special-purpose detergent for cotton fabrics
- Visibly renews fabric with just one wash
- Special Miele formula with Novozymes technology
- Removes pilling and renews colour intensity and brightness
- Depending on fabric do not use more than 1–2 times per year

Detergents and care products

Fabric care

These fabric care products are available as convenient single-use capsules.

Fabric conditioner cap

- Fabric conditioner for freshly scented laundry
- Pure and thorough cleanliness with a fresh scent
- For soft, bouncy laundry
- Prevents static charge in clothes

Additives

Additives are available as convenient single-use capsules.

Cap Booster

- Highly effective stain remover
- Enzyme technology to help remove stubborn stains
- Suitable for whites and colours
- For best wash results even at low temperatures

Machine care

TwinDosCare

- Cleaning agent for the TwinDos dispensing system
- Use before a prolonged downtime (at least 2 months)
- Use before changing to a different product

Descaling agent

- Removes heavy limescale deposits
- Mild and gentle with natural citric acid
- Gentle on heater elements, drum and other components

IntenseClean

- For hygienic cleanliness in washing machines
- Removes grease, bacteria and associated unpleasant odours
- Effective thorough cleaning

Water softener tablets

- Reduces the amount of detergent needed for hard water
- Less detergent residue in fabrics
- Less chemicals in waste water due to reduced amount of detergent

Singapore

Miele Pte. Ltd.
29 Media Circle
#11-04 ALICE@Mediapolis
Singapore 138565
sTel: +65-67351191
Fax: +65-67351161
E-Mail: info@miele.com.sg
Internet: www.miele.sg

Malaysia

Miele Sdn Bhd
Suite 12-2, Level 12
Menara Sapura Kencana Petroleum
Solaris Dutamas No. 1
Jalan Dutamas 1
50480 Kuala Lumpur, Malaysia
Phone: +603-6209-0288
Fax: +603-6205-3768

Germany

Miele & Cie. KG
Carl-Miele-Straße 29
33332 Gütersloh

Hong Kong, China

Miele (Hong Kong) Limited
41/F - 4101, Manhattan Place
23 Wang Tai Road, Kowloon Bay
Hong Kong
Tel: (852) 2610 1025
Fax: (852) 3579 1404
Email: customerservices@miele.com.hk
Website: www.miele.hk

Thailand

Miele Appliances Ltd.
BHIRAJ TOWER at EmQuartier
43rd Floor Unit 4301-4303
689 Sukhumvit Road
North Klongton Sub-District
Vadhana District
Bangkok 10110, Thailand

WWI 860

en-SG

M.-Nr. 11 751 681 / 00