

Operating instructions for washing machines



To avoid the risk of accidents or damage to the machine, it is **essential** to read these instructions before it is installed and used for the first time.





Contents

Caring for the environment	6
Warning and Safety instructions	7
Operating the washing machine	14
Control panel	14
Touch display and sensor controls.....	14
Main menu.....	15
Examples on how to operate the machine	16
Moving programmes	17
Before using for the first time	19
Miele@home	20
1. Set the language	21
2. Setting up Miele@home	21
3. Set clock format	22
4. Remove the transit bars	22
5. Commissioning TwinDos	23
6. Start the calibration programme.....	26
Washing environmentally and economically	27
Hygiene in the washing machine.....	27
Feedback.....	28
1. Prepare the laundry	29
2. Select a programme	30
3. Select programme settings	31
4. Load the washing machine	33
5. Add detergent	34
TwinDos.....	34
Detergent dispenser drawer	36
CapDosing.....	38
6. Starting the programme	40
Adding laundry during a programme sequence (AddLoad)	40
7. End of programme	41
Spinning	42
Programme chart	44
Garment care label symbols	51

Extra options	52
Quick	52
Water plus	52
Extra rinse.....	52
SingleWash.....	52
Pre-wash	52
Soak	52
Intensive	53
AllergoWash	53
Extra gentle	53
Extra quiet	53
Rinse hold.....	53
Wash programme chart - Extras	54
Programme sequence	56
Changing the programme sequence	59
Changing a programme (safety lock)	59
Interrupting a programme.....	59
Cancelling a programme	59
Favourite programmes	60
Washing assistant	61
Timer	62
SmartStart	63
Detergent	64
The correct detergent.....	64
Water softeners	64
Dispensing aids	64
Fabric conditioner and liquid starch.....	64
Recommended Miele detergents	66
Recommended detergents in accordance with Directive (EU) Nr. 1015/2010....	67
Replacing the TwinDos cartridge	68
Cleaning and care	69
Cleaning the external casing and the control panel	69
Cleaning the detergent dispenser drawer	69
Cleaning the drum (Hygiene info)	71
TwinDos maintenance	71
Cleaning the water inlet filter	72

Contents

Problem solving guide	73
The programme does not start.....	73
Fault message after a programme has been interrupted.	74
Fault message at the end of a programme	75
Messages or faults with the TwinDos system	77
General problems with the washing machine	79
An unsatisfactory wash result	81
The door will not open.....	82
Opening the door in the event of a blocked drain outlet and/or power cut	83
Service	85
Contact in the event of a fault	85
Optional accessories.....	85
Guarantee.....	85
Installation	86
Front view	86
Rear view.....	87
Installation surface	88
Transporting the washing machine to its installation site.....	88
Removing the transit bars	89
Fitting the transit bars	91
Levelling the machine.....	92
Screwing out and adjusting the feet.....	92
Installing under a continuous worktop	93
Washer-dryer stack	93
The water protection system.....	94
Connection to the water supply	96
Water drainage	98
Fitting the elbow.....	98
Direct connection to a sink drain outlet.....	99
Electrical connection	100
Consumption data	101
Note for test institutes	101
Technical data	102
Settings	103
Selecting settings.....	103
Changing a setting	103
Closing the settings menu.....	103

Controls / Display 	104
Language 	104
Consumption	104
Code	104
Memory	105
Clock display	105
Volume	105
Display brightness	105
Units	105
“Display” off status	105
Programme sequence	106
TwinDos	106
Soiling	106
Water plus level	106
Maximum rinse level	107
Soak duration	107
Longer Pre-wash Cottons	107
Gentle action	107
Anti-crease	107
Network	108
Miele@home	108
SmartGrid	109
Remote control	109
RemoteUpdate	110
Appliance parameters	111
Legal information	111
Copyrights and licences for operator and control software	111
Copyrights and licences for the communication module	111
Installation requirements	112
Low water pressure	112
Suds cooling	112
Temperature reduction	112
Detergents and care products	113
Detergent	113
Specialist detergents 	114
Fabric care 	115
Additives 	115
Machine care	115

Caring for the environment

Disposing of the packaging material

The packaging material is used for handling and protects the appliance from transport damage. The packaging material used is selected from materials which are environmentally friendly for disposal and can generally be recycled.

Recycling the packaging material reduces the use of raw materials. Use material-specific collection points for valuable materials and take advantage of return options. Your Miele dealer will take the packaging material away.

Disposing of your old appliance

Electrical and electronic appliances often contain valuable materials. They also contain specific materials, compounds and components, which were essential for their correct function and safety. These could be hazardous to human health and to the environment if disposed of with your domestic waste or if handled incorrectly. Please do not, therefore, dispose of your old appliance with your household waste.



Please dispose of it at your local community waste collection / recycling centre for electrical and electronic appliances, or contact your dealer or Miele for advice. You are also responsible (by law, depending on territory) for deleting any personal data that may be stored on the appliance being disposed of. Please ensure that your old appliance poses no risk to children while being stored prior to disposal.

Warning and Safety instructions

This washing machine complies with all current local and national safety requirements. However, inappropriate use can lead to personal injury and damage to property.

Read the operating instructions carefully before using the washing machine. They contain important information on safety, installation, use and maintenance. This prevents both personal injury and damage to the washing machine.

In accordance with standard IEC 60335-1, Miele expressly and strongly advises that you read and follow the instructions in the chapter on installing the washing machine as well as the safety instructions and warnings.

Miele cannot be held liable for damage caused by non-compliance with these instructions.

Keep these operating instructions in a safe place and pass them on to any future owner.

Correct application

- ▶ This washing machine is intended for use in domestic households and similar working and residential environments.
- ▶ The washing machine is not intended for outdoor use.
- ▶ It must be used only as a domestic appliance to wash items which are specified by the manufacturer as being washable on the wash care label. Miele cannot be held liable for damage resulting from incorrect or improper use or operation.
- ▶ The washing machine can only be used by people with reduced physical, sensory or mental capabilities, or lack of experience or knowledge, if they are supervised whilst using it or have been shown how to use it safely and recognise and understand the consequences of incorrect operation.

Warning and Safety instructions

Safety with children

- ▶ Children under 8 years of age must be kept away from the washing machine unless they are constantly supervised.
- ▶ Children 8 years and older may only use the washing machine unsupervised if they have been shown how to use it safely and recognise and understand the consequences of incorrect operation.
- ▶ Children must not be allowed to clean or maintain the washing machine unsupervised.
- ▶ Please supervise children in the vicinity of the washing machine and do not let them play with it.

Technical safety

- ▶ Please observe the instructions in “Installation” and “Technical data”.
- ▶ Before setting up the washing machine, check it for any externally visible damage. Do not install or use a damaged machine.
- ▶ Before connecting the washing machine, ensure that the connection data on the data plate (fuse rating, voltage and frequency) match the mains electricity supply. If in any doubt, consult a qualified electrician.

Warning and Safety instructions

► Temporary or permanent operation on an autonomous power supply system or a power supply system that is not synchronised with the mains power supply (e.g. island networks, back-up systems) is possible. A prerequisite for operation is that the power supply system complies with the specifications of EN 50160 or an equivalent standard.

The function and operation of the protective measures provided in the domestic electrical installation and in this Miele product must also be maintained in isolated operation or in operation that is not synchronised with the mains power supply, or these measures must be replaced by equivalent measures in the installation. As described, for example, in the current version of BS OHSAS 18001–2 ISO 45001.

► The electrical safety of this washing machine can only be guaranteed when correctly earthed.

It is essential that this standard safety requirement is met. If in any doubt, please have the wiring system of the building tested by a qualified electrician.

Miele cannot be held liable for the consequences of an inadequate earthing system (e.g. electric shock).

► Do not connect the washing machine to the mains electricity supply by a multi-socket adapter, extension lead or similar. These do not guarantee the required safety of the machine (fire hazard due to the risk of overheating).

► Faulty components must only be replaced by genuine Miele original spare parts. Only when these parts are fitted can Miele guarantee the safety standards of the machine.

► The electrical socket must be easily accessible after installation so that the machine can be disconnected from the electricity supply if necessary.

Warning and Safety instructions

- ▶ Unauthorised repairs could result in unforeseen dangers for the user, for which the manufacturer cannot accept liability. Repairs should only be undertaken by a Miele authorised service technician, otherwise any subsequent damage will not be covered by the warranty.
- ▶ While the washing machine is under warranty, repairs should only be undertaken by a Miele authorised service technician. Otherwise the warranty will be invalidated.
- ▶ If the electrical connection cable is faulty it must only be replaced by a Miele authorised service technician to protect the user from danger.
- ▶ The machine must be isolated from the electricity supply when cleaning and maintaining the machine and in the event of a fault.
- ▶ The Miele “Water protection system” protects from water damage provided the following conditions are met:
 - the machine is correctly plumbed in and connected to the electricity supply.
 - if a fault or damage has been identified, the machine must be examined by a competent person before further use, and repaired if necessary.
- ▶ The water flow pressure must be at least 100 kPa and should not exceed 1000 kPa.
- ▶ In areas which may be subject to infestation by cockroaches or other vermin, pay particular attention to keeping the machine and its surroundings in a clean condition at all times. Any damage which may be caused by cockroaches or other vermin will not be covered by the warranty.
- ▶ The machine must not be used in a non-stationary location (e.g. on a ship).
- ▶ Do not make any alterations to the machine, unless authorised to do so by Miele.

Warning and Safety instructions

▶ This washing machine is supplied with a special lamp to cope with particular conditions (e.g. temperature, moisture, chemical resistance, abrasion resistance and vibration). This lamp must only be used for the purpose for which it is intended. The lamp is not suitable for room lighting. Replacement lamps may only be fitted by a Miele authorised technician or by the Miele Customer Service Department.

This washing machine contains 1 light source corresponding to energy efficiency rating G.

Correct use

▶ Do not install the washing machine in a room where there is a risk of frost. Frozen hoses may burst or split. The reliability of the electronic control unit may be impaired at temperatures below freezing point.

▶ Before using the machine for the first time, check that the transit bars at the rear of the machine have been removed (see “Installation - Removing the transit bars”). During spinning, a transit bar which is still in place may result in damage to both the machine and adjacent furniture or appliances.

▶ Turn off the stopcock if the machine is to be left for any length of time (e.g. holiday), especially if there is no floor drain (gully) in the immediate vicinity.

▶ Flooding danger.

If hooking the drain hose into a wash basin, check that the water can drain off quickly enough to prevent the sink from overflowing. Make sure the drain hose is secure, so that the force of the water flowing out of the hose does not dislodge it.

▶ Take care to ensure that foreign objects (e.g. nails, pins, coins, paper clips) do not find their way into the machine with the laundry. These may damage components of the machine (e.g. suds container, drum), which in turn can result in damage to the laundry.

Warning and Safety instructions

- ▶ Take care when opening the drum door after using the steam function. Danger of burning due to escaping steam and the high temperature of the surface of the drum as well as the porthole glass. Stand back away from the machine and wait until the steam has dissipated.
- ▶ The maximum load for this washing machine is 9.0 kg (dry weight). See the “Programme chart” for the maximum recommended loads for individual programmes.
- ▶ If the correct amount of detergent is dispensed, the machine should not need to be descaled. If, however, you do wish to descale it, only use a proprietary natural citric acid based descaling agent. Miele recommends using Miele descaling agent which is available to order from your Miele dealer. Strictly observe the instructions on the packaging.
- ▶ Textiles which have been pre-treated in solvent based cleaning agents must be thoroughly rinsed in clean water before being washed in the machine.
- ▶ Do not use solvent based cleaning agents, e.g. those containing benzene, in this machine, as this may result in damage to component parts and create toxic fumes. Such agents also pose a fire and explosion hazard.
- ▶ Do not use solvent based cleaning agents, e.g. those containing benzene, to clean the surfaces of the machine. They can cause damage to plastic surfaces.
- ▶ Only use dyes specified by the manufacturer as being suitable for use in a domestic washing machine. Always observe the manufacturer's instructions carefully.
- ▶ Colour run and dye removers contain sulphur compounds which can cause damage such as corrosion. Do not use these products in this machine.

Warning and Safety instructions

▶ If detergent comes into contact with the eyes, rinse them thoroughly with lukewarm water immediately. If swallowed, seek medical assistance immediately and retain the packaging or label for reference. Those with skin problems or sensitive skin should avoid their skin coming into contact with detergent.

Accessories and spare parts

▶ Only use original Miele accessories and spare parts. If other parts are used, warranty, performance and product liability claims will be invalidated.

▶ A Miele tumble dryer can be stacked on top of a Miele washing machine using the appropriate stacking kit (available as an optional accessory). Please make sure you order the correct one for the Miele washing machine and Miele tumble dryer.

▶ If installing the machine on a Miele plinth, (available as an optional accessory, depending on country), please make sure you order the correct one for this washing machine.

▶ Miele will guarantee to supply functional spare parts for a minimum of 10 years and up to 15 years following the discontinuation of your washing machine.

Miele cannot be held liable for damage caused by non-compliance with these Warning and Safety instructions.

Operating the washing machine

Control panel

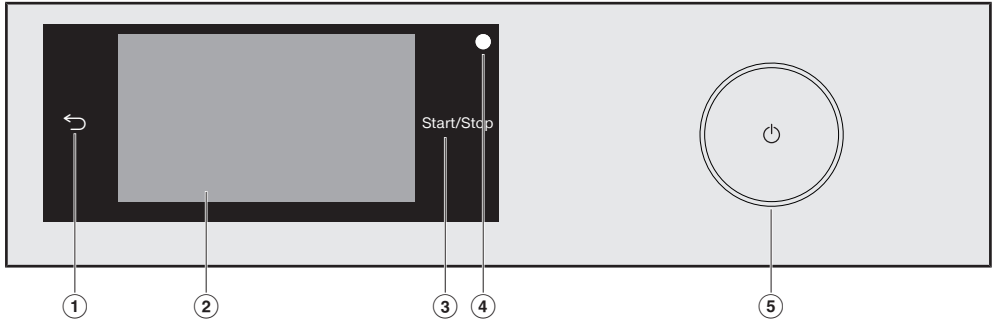

- ① **Sensor** ↶
To go back a level in a menu.
- ② **Touch display**
- ③ **Start/Stop** sensor control
Touching the *Start/Stop* sensor control starts the selected programme or cancels a programme that has already been started. The programme can be started as soon as the sensor control is flashing on and off. The sensor control lights up constantly once the programme has started.
- ④ **Optical interface**
This is used by the Service department as a transmission point.
- ⑤ **Sensor** ⏻
For switching the washing machine on and off. To save energy, the washing machine will switch off automatically. This occurs 15 minutes after the end of the programme/anti-crease phase, or after being switched on if no further selection is made.

Touch display and sensor controls

The ↶ and *Start/Stop* sensors and the sensors in the display react to finger tip contact.

The touch display can be scratched by pointed or sharp objects, e.g. pens. Only touch the display with your fingers.

Operating the washing machine

Main menu

After switching on the washing machine, the main menu will appear in the display.

You can access all the important sub-menus from the main menu.

Touch the  sensor control at any time to return to the main menu. Values set previously are not saved.

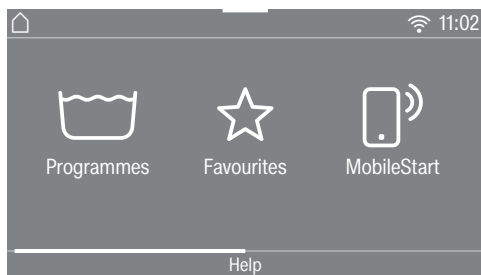

Main menu page 1

You can scroll to the second page of the main menu by swiping your finger across the display.

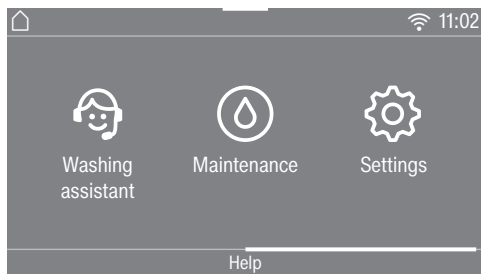

Main menu page 2

The  symbol next to the time of day is displayed when the washing machine is connected to a network.

Programmes

You can select the various wash programmes.

Favourites

You can save up to 12 of your own customised wash programmes (see “Favourites”).

MobileStart

MobileStart enables you to operate your washing machine remotely with the Miele app.

The Remote control setting must be switched on.

Touch the MobileStart sensor control and follow the instructions in the display.

Washing assistant

The *Washing assistant* provides a step-by-step guide to selecting the optimum wash programme for your laundry (see “Washing assistant”).

Maintenance

Maintenance options for the TwinDos system and the Clean machine programme are located in the Maintenance menu (see “Cleaning and care”).

Settings

You can alter the washing machine’s electronics to suit changing requirements in the *Settings* menu (see “Settings”).

Operating the washing machine

Examples on how to operate the machine

Option lists

Programmesmenu (single selection)

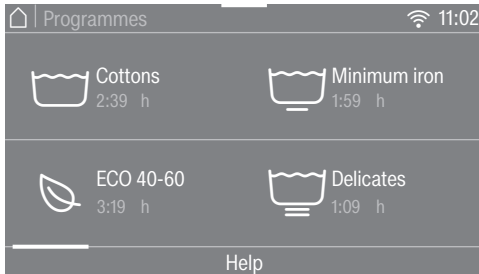

You can scroll right or left by swiping your finger across the screen. Place your finger on the touch display and swipe it in the direction you want.

The orange bar under the pictures shows that there are further options to choose from.

To select a wash programme, touch a programme name.

The display will change to the standard menu for that programme.

Extrasmenu (multiple selection)



You can scroll right or left by swiping your finger across the screen. Place your finger on the touch display and swipe it in the direction you want.

The orange bar under the pictures shows that there are further options to choose from.

To select *Extras*, touch one or several sensor controls with *Extras*.

Currently selected *Extras* are marked orange.

To deselect an *Extra*, simply touch the *Extra* sensor control again.

Touch the OK sensor control to activate all selected *Extras*.

Operating the washing machine

Moving programmes

You can move the programmes around in the menu to change the sequence in which they are displayed.



- Place your finger on the programme you wish to move until a border is displayed around it.
- To move the programme, swipe your finger in the required direction.
- Remove your finger when the programme reaches the new location. The programme has moved.

Setting numerical values

You can set numerical values in some menus.

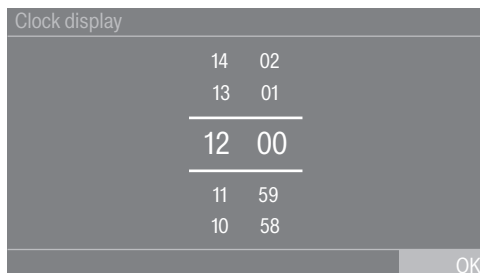

Enter the numbers by swiping up or down. Place your finger on the number that you want to change and move your finger in the direction you want. Touch the OK sensor control to accept the set numerical value.

Tip: Briefly touching the numbers will bring up the numerical keypad. Once a valid number has been entered, the OK sensor control will be highlighted green.

Operating the washing machine

Pull-down menu

The pull-down menu can be used to display information, e.g. about a wash programme.



Touch the top edge of the screen in the middle and drag down with your finger.

Help display

Help appears along the bottom line of the display in the main menu and the Programmes menu.

- Touch the **Help** sensor control to display the text.
- Touch the **Close** sensor control to return to the previous screen.

Exiting a menu

- Touch the **↶** sensor control to return to the previous screen.
- Entries made before this which have not been confirmed with **OK** will not be saved.

Before using for the first time

 Damage resulting from incorrect installation and connection. Installing and connecting the washing machine incorrectly will cause serious property damage. See "Installation".

This washing machine has undergone a complete functional test at the factory and there will be some residual water in the drum from this process.

Removing the protective foil and stickers

- Remove:
 - Any protective film from the door
 - Any stickers from the front and the lid

Please do not remove any labels (e.g. the data plate) which are visible when you open the door.

Remove the detergent cartridges and the drain hose elbow from the drum

Two detergent cartridges for automatic detergent dispensing and an elbow piece for the drain hose are stored in the drum.

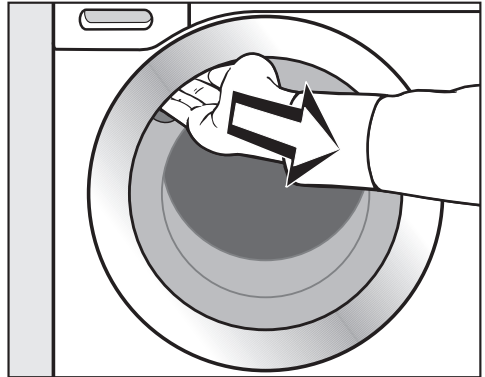

- Reach under the door grip and pull the door open.
- Take the two cartridges and the elbow piece out of the drum.

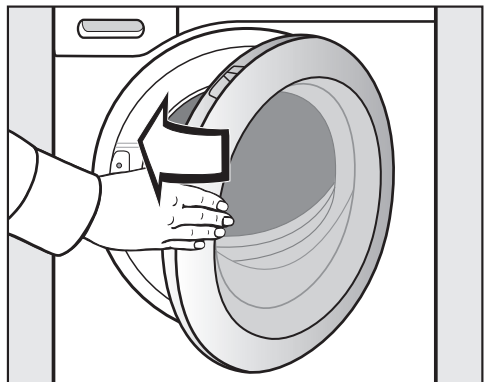

- Shut the door with a gentle swing.

Before using for the first time

Miele@home

Your washing machine is equipped with an integrated WiFi module.

In order to use it you need:

- a WiFi network
- the Miele@mobile App
- a Miele user account. The user account can be created via the Miele@mobile App.

The Miele@mobile App will guide you as you connect your washing machine to your home WiFi network.

Once your washing machine is connected to your WiFi network you can use the App, for example, to carry the following activities:

- Operate your washing machine remotely
- Access information about the operating status of your washing machine
- Access information about a programme sequence on your washing machine

Connecting your washing machine to your WiFi network will increase energy consumption, even when the washing machine is switched off.

Before installing the washing machine in its final location, ensure the signal strength is sufficient for your WiFi network.

Availability of the WiFi connection

The WiFi connection shares a frequency range with other appliances (including microwave ovens and remote control toys). This can give rise to sporadic or even complete connection failures. Therefore, the availability of featured functions cannot be guaranteed.

Miele@home availability

The ability to use the Miele app depends on the availability of the Miele@home service in your country.

The Miele@home service is not available in every country.

For information about availability, please visit www.miele.com.

Miele App

The Miele App is available to download free of charge from the Apple App Store® or from the Google Play Store™.



Switch on the washing machine

- Press the  button.

The welcome screen will light up.

The display will guide you through the **6 steps** of the initial commissioning process.

1. Set the language

You will be asked to select the language you require for the display. It is possible to change the language at any time via the settings menu.

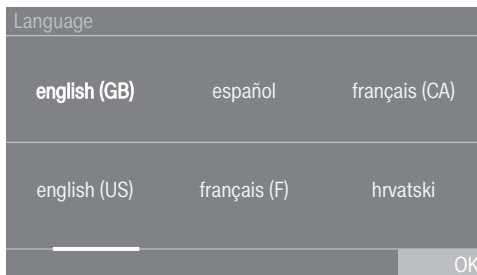

- Scroll to the left or the right until the language you want appears.
- Touch the sensor for the language you want.

The selected language will be highlighted in orange and the display will change to the menu for setting up Miele@home.

2. Setting up Miele@home



- To set up Miele@home now: Touch the **Continue** sensor control.

Tip: To postpone setup until later: Touch the **Skip** sensor control. The following message will then appear in the display:

i It is possible to set up later in "Settings" / "Miele@home".

Confirm with the **OK** sensor control.

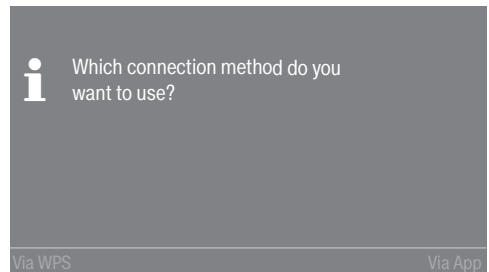

- Select the connection method you wish to use.

You will then be guided by the display and the Miele app.

Before using for the first time

3. Set clock format

The time of day can be displayed in 12-hour or 24-hour clock format.

- Select the clock format you want and confirm this with the OK sensor control.

The display will then bring up the screen for setting the time of day.

Setting the time

This message only appears if the washing machine has not yet been connected to a WiFi network.

The time of day is set automatically when a connection is established with a WiFi network.

Clock display

14 02

13 01

12 00

11 59

10 58

OK

- Place your finger on the number that you want to change and move your finger in the direction you want.
- Confirm with the OK sensor control.

4. Remove the transit bars

 Damage resulting from failure to remove the transit bars.

Failure to remove the transit bars can result in damage to the washing machine and to adjacent cabinetry or appliances.

Remove the transit bars as described in “Installation and connection”.

- Touch the OK sensor control to confirm that the transit bars have been removed.

The following message will then appear in the display:

 Remove transit bars and observe “Warning and Safety instructions” and “Before using for the first time” in the operating instructions.

- Confirm the message with the OK sensor control.

The display will then change to the screen for setting up TwinDos.

Before using for the first time

5. Commissioning TwinDos

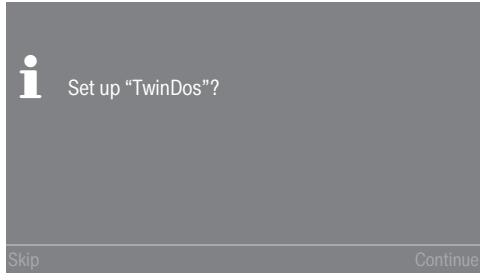

- Touch the **Continue** sensor control to set TwinDos up straight away.

Tip: To postpone setup until later: Touch the **Skip** sensor control. The following message will then appear in the display:

i It is possible to set up later in “Settings” / “TwinDos”.

Confirm with the **OK** sensor control.

Settings for compartment ①

The procedure below describes the procedure for Miele UltraPhase 1 and Miele UltraPhase 2. The procedure for other detergents is similar.

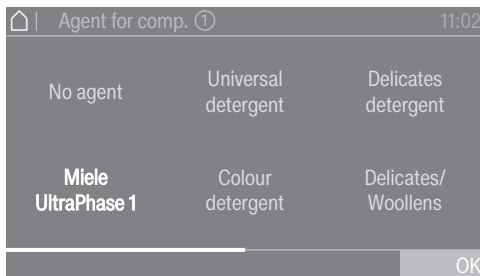

- Touch the **Miele UltraPhase 1** sensor.



The following message will then appear in the display:

i Please enter the dosing recommendation of your detergent for a wash with normal soiling. Take note of your water hardness level.

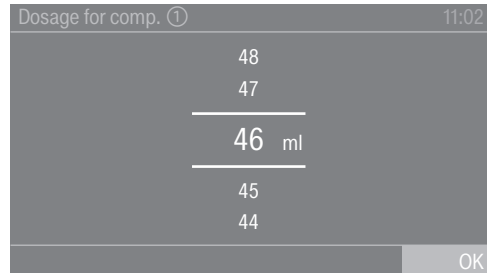
The dispensing quantity for UltraPhase 1 is pre-set for  (hardness level I)



- Confirm the pre-set value with the **OK** sensor, or change the value.

UltraPhase 1		
	Hardness level I	46 ml
	Hardness level II	58 ml
	Hardness level III	70 ml

Before using for the first time

The following appears in the display:

i Insert container ①



- Remove the cover cap from the **UltraPhase 1** detergent cartridge included with the delivery.

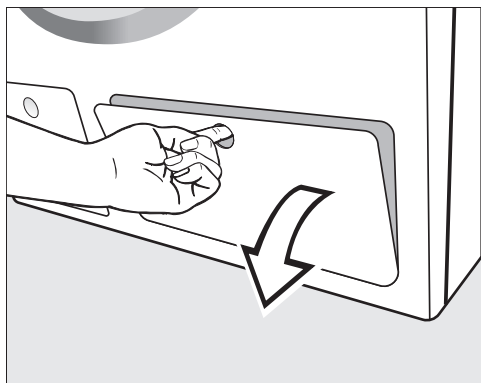

- Open the access panel for TwinDos.

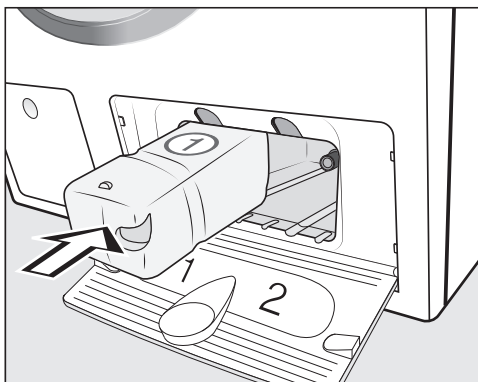

- Push the **UltraPhase 1** detergent cartridge into **compartment 1** until it locks into position.

The following message appears in the display:

i Now enter the settings for UltraPhase 2



Before using for the first time

Settings for compartment ②

The dispensing quantity for UltraPhase 2 is pre-set for  (hardness level I)

Dosage for comp. ②		11:02
	38	
	37	
	<hr/>	
	36 ml	
	<hr/>	
	35	
	34	
		OK

- Confirm the pre-set value with the OK sensor, or change the value.

UltraPhase 2		
	Hardness level I	36 ml
	Hardness level II	45 ml
	Hardness level III	54 ml

The following appears in the display:

 Insert container ②

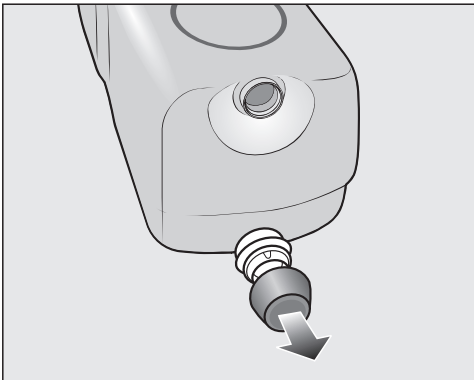

- Remove the cover cap from the UltraPhase 2 detergent cartridge included with the delivery.



- Push the UltraPhase 2 detergent cartridge into **compartment 2** until it locks into position.

When the cartridge is pushed in, the message in the display changes to:

 "TwinDos" is set up. Changes can be made in "Settings" / "TwinDos".

- Confirm with the OK sensor control.
- Close the TwinDos access panel.

The display will then change to the calibration programme.

Before using for the first time

6. Start the calibration programme

For optimum water and energy consumption and excellent wash results, it is important to calibrate the washing machine.

To do this, the *Cottons* programme **must** be run without laundry.

No other programmes can be started until calibration has been carried out.

The following message will then appear in the display:

i Open the stopcock and run the “Cottons 90°C” programme with an empty drum

■ Confirm with the **OK** sensor control.

The display will then change to the standard display for the *Cottons* programme.

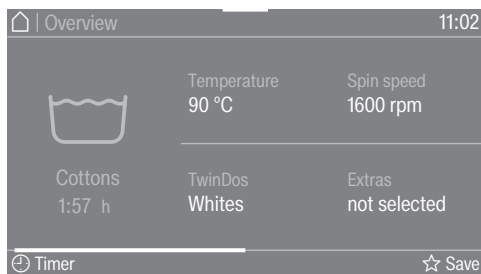

■ Touch the **Start/Stop** sensor control.

The calibration programme then starts. It will take approximately 2 hours.

At the end of the programme the following message will appear in the display:

i Set up complete

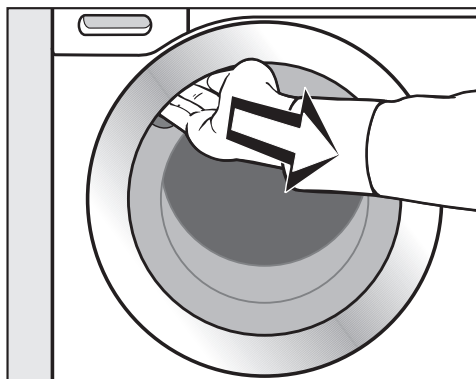

■ Reach under the door grip and pull the door open.

Tip: Leave the door slightly open to allow the drum to dry.

■ Switch the washing machine off with the **power** control.

Washing environmentally and economically

Energy and water consumption

- To get the most out of your machine, load the maximum dry load size for the wash programme you are using. This will keep the energy and water consumption to a minimum in relation to the size of the load.
- Programmes that are more efficient with regard to energy and water consumption generally have a longer running time. By extending the programme running time, the wash temperature that is actually reached can be reduced while still providing the same wash results.

For example, the ECO 40-60 programme has a longer running time than the Cottons 40 °C or 60 °C programme. The ECO 40-60 programme is more efficient in terms of energy and water consumption but has a longer running time.

- Use the Express 20 programme for small, lightly soiled loads.
- Modern detergents make it possible to wash at lower temperatures (e.g. 20 °C). Using lower temperature settings will save energy.

Hygiene in the washing machine

Washing at low temperatures and/or using liquid detergents can cause bacteria and odours to build up in the washing machine. Miele therefore recommends cleaning the washing machine once every month.

When the message **Hygiene info: Select "Maintenance"** and run the "Clean machine" programme. **appears in the display, the washing machine must be cleaned.**

Information about subsequent tumble drying

The spin speed selected affects the residual moisture in the laundry and the sound emissions of the washing machine.

The higher the spin speed, the lower the residual moisture in the laundry. However, the sound emissions of the washing machine will increase.

Select the highest possible spin speed for the wash programme to save energy in the subsequent tumble dryer cycle.

Washing environmentally and economically

Feedback

You can view information about the energy and water consumption of your washing machine with the pull-down menu.

The following information will appear in the display:

- An estimate of the energy and water consumption before the programme begins.
- The actual energy and water consumption during the programme or at the end of the programme.



- Open the pull-down menu.

1. Estimate

The estimated energy and water consumption levels will be displayed as a bar chart on the right-hand side.

The more bars visible, the higher the energy or water consumption.

The estimate will vary depending on the wash programme, temperature and any Extras selected.

2. Actual consumption

You can view the actual amount of energy and water used by a programme both during and at the end of the programme.

The costs can also be displayed. See “Settings - Consumption” for more detailed information on costs.

The consumption will alter as the programme progresses.

If the door is opened or the machine has switched off automatically at the end of the programme, the data will revert to the estimated consumption.

Tip: You can view the consumption data for the last wash programme and for total consumption (see “Settings, Consumption”).

1. Prepare the laundry



- Empty all pockets.

⚠ Damage due to foreign objects. Nails, coins, paper clips, and so on can cause damage to garments and components in the machine. Check the laundry before washing and remove any foreign objects.

Sort the laundry

- Sort the laundry by colour and by care label. Most garments have a textile care label in the collar or side seam.

Tip: Dark textiles often contain excess dye and should be washed separately several times before being included in a mixed load. Always wash whites and coloureds separately.

Pre-treating stains

- Badly soiled areas and stains should be cleaned as soon as possible, preferably whilst still fresh. Spillages should be carefully dabbed off using a soft, colourfast cloth. Do not rub.

Tip: Stains (e.g. blood, egg, coffee, tea) can be pre-treated using some handy tricks which can be found in the Miele guide to laundry care.

⚠ Damage due to solvent-based cleaning agents
Cleaning agents containing benzene, stain remover, etc., can damage plastic parts.
When pre-treating textiles, make sure that any plastic parts (e.g. buttons) do not come into contact with cleaning agent.

⚠ Risk of explosion due to solvent-based cleaning agents.
When using solvent-based cleaning agents, an explosive mixture may develop.
Never use solvent-based cleaning agents in the washing machine.

General tips

- Curtains: remove rollers and lead weights or place in a laundry bag.
- Sew in or remove any loose underwiring in bras.
- Close any zips, attach velcro fasteners, fasten hooks and eyes, etc. before washing.
- Fasten duvet covers and pillow cases to prevent small items from becoming rolled up inside them.

Do not wash items which are specified by the manufacturer as **not washable** according to the symbol on the care label (☒ symbol).

2. Select a programme

Switching on the washing machine

- Press the  control.

The interior drum lighting will come on.

The drum lighting will go out automatically after 5 minutes.

Tip: To switch the lighting on again, open the pull-down menu from the overview menu and then touch the  sensor.

The main menu will then appear in the display.

Selecting a programme

- Touch the Programmes sensor.

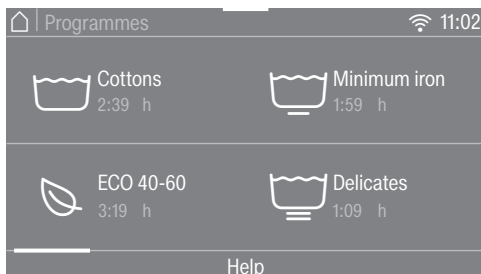

- Scroll to the right of the display until the programme you want appears.
- Touch the sensor for that programme.

The display will then change to show the Overview menu.

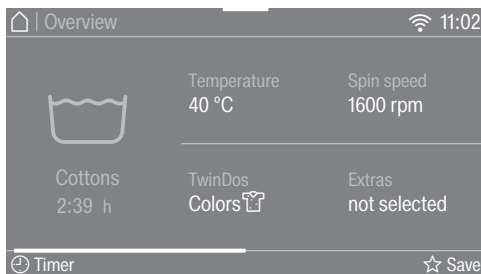

There are 3 different ways of selecting a programme.

1. Favourites
2. Washing assistant
3. MobileStart

3. Select programme settings

Selecting a temperature

You can alter the preset temperature of a wash programme.

The temperatures reached inside the washing machine might not be the same as the temperatures selected. Perfect wash results are achieved through a combination of energy use and wash duration.

- Touch the **Temperature sensor**.
- Select the desired temperature.

The display will change to the **Overview menu**.

Selecting a spin speed

You can alter the preset spin speed of a wash programme.

- Touch the **Spin speed sensor**.
- Select the spin speed you want.

The display will then change to show the **Overview menu**.

Activating TwinDos

TwinDos dispensing is automatically activated for all programmes in which dispensing is possible.

1. Switch TwinDos on or off

- Touch the **TwinDos sensor** and select **Off** or **On**.

2. Select the detergent

When using Miele's 2-phase system you must set the colour of the laundry.

- Select **Whites** for loads of white items, or **Colours** for loads containing coloured items.

If using a different type of detergent, this must be selected.

- Select compartment ① or ②.

Tip: Only those detergents that can be used with the programme are displayed.

3. Selecting the degree of soiling

The display will ask you to enter the degree of soiling of the laundry.

- Select **Light**, **Normal** or **Heavy**.
- Confirm your selection with the **OK sensor control**.

Automatic dispensing is now switched on.

The display will change to the **Overview menu**.

See "5. Adding detergent – TwinDos" for more information.

3. Select programme settings

Selecting Extras

You can supplement the wash programmes with Extras.

- Touch the Extras sensor control.
- Select one or more Extras.

Not all Extras can be used with every programme, e.g. AllergoWash, Extra gentle and Extra quiet. Extras that cannot be combined are blended out and cannot be selected.

- Confirm with the OK sensor control.

The display will change to the Overview menu.

See “Extras” for further information.

Activating CapDosing

You can use CapDosing with this wash programme.

- Touch the CapDosing sensor.

The types of capsules which can be used with the programme will appear in the display.

- Select the type of capsule you want.

CapDosing is now active.

The display will then change to show the Overview menu.

See “5. Add detergent – CapDosing” for more information.

Selecting stains

In order to clean stained laundry more effectively, you can choose from a list of various types of stains. The wash programme will then adapt to the type of stain selected.

- Touch the Stains sensor control.
- Select the types of stains in your load from the list.
- Confirm your selection with the OK sensor control.

With some stains, helpful information will also appear in the display when they are selected.

- Confirm the information with the OK sensor control.

The display will change to the Overview menu.

Timer

You can use the Timer to set the finish time or the start time for a wash programme.

See “Timer” for further information.

4. Load the washing machine

Open the door



- Reach under the door grip and pull the door open.

Check the drum for pets or foreign objects before loading it with laundry.

The most efficient use of energy and water is achieved when a full load is washed. However, do not overload as this reduces cleaning efficiency and causes creasing.

- Unfold the laundry and load loosely into the drum.

Mixing both large and small items gives better wash results and also helps distribute the load evenly during spinning.

Tip: The maximum load for the programme selected will appear in the pull-down menu.

Close the door

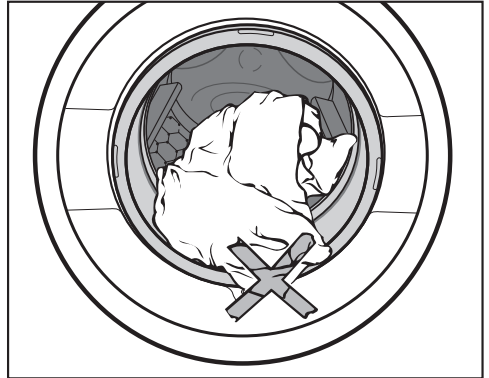

- Make sure that no items are caught between the door and the seal.

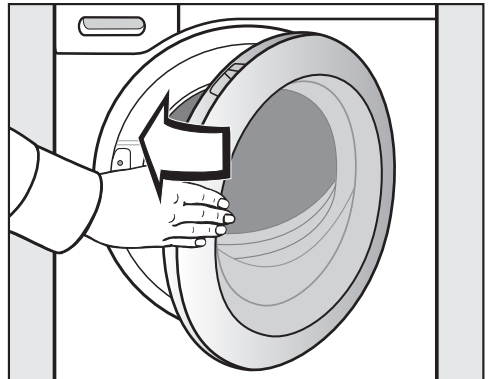

- Shut the door with a gentle swing.

5. Add detergent

There are several options for adding detergent.

TwinDos

The washing machine has the TwinDos system.

TwinDos has to be activated as described in “Before using for the first time”.

How UltraPhase 1 and UltraPhase 2 work

UltraPhase 1 is a liquid detergent which dissolves dirt and removes the most common stains. UltraPhase 2 is a bleaching agent and removes stubborn stains. For the best washing result, these two agents are dispensed at separate times during the washing process. UltraPhase 1 and UltraPhase 2 clean white and coloured fabrics thoroughly. UltraPhase 1 and UltraPhase 2 single-use cartridges are available to order from Miele, your Miele dealer or via the Miele online shop.

Activating TwinDos dispensing

TwinDos dispensing is automatically activated for all programmes in which dispensing is possible.

Tip: The detergent dispensing quantities are pre-set. If too much foam builds up, the dispensing quantity can be reduced via the  Settings, Programme sequence, TwinDos menu.

Changing TwinDos dispensing

You can change the suggested colour composition of the laundry.

- Touch the TwinDos sensor and select the colour composition of your laundry.

Deactivating TwinDos dispensing

- Touch the TwinDos sensor.
- Touch the Off sensor.



Using other methods to remove stains

If you wish to use additional methods of stain removal, you have the following options:

- Using the Booster cap and activating the CapDosing.
- Add stain remover to the  compartment.

Level of soiling

The level of soiling in laundry is split into three settings:

-  Light
No visible soiling or stains
-  Normal
Visibly soiled and/or just a few slight stains
-  Heavy
Heavily soiled and/or stains clearly visible.

The dispensing amount for TwinDos and the amount of water required for rinsing is pre-set for the  Normal level of soiling.

- Touch the TwinDos sensor to select a different level of soiling.

The amount of detergent and water will be adjusted to suit the selected level of soiling.

Some programmes will not let you set the level of soiling. These programmes are designed for lightly soiled laundry only.

5. Add detergent

Detergent dispenser drawer

Any detergent suitable for automatic front loading washing machines can be used. Please observe the instructions for use and dosage on the detergent packaging.

Ensure that TwinDos dispensing is deactivated.

Adding detergent

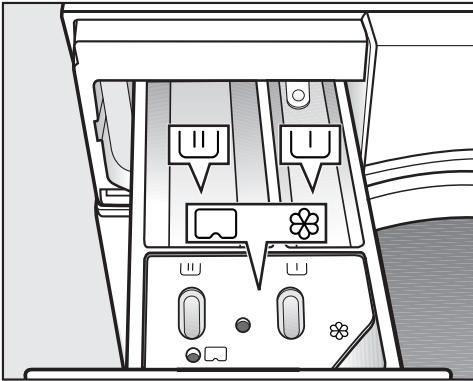

- Pull out the detergent drawer and add detergent to the compartments.

- ▭ Detergent for the pre-wash
- ▭ Detergent for the main wash and soaking
- ⊗ Fabric softener, liquid starch, or capsules

Adding fabric conditioner

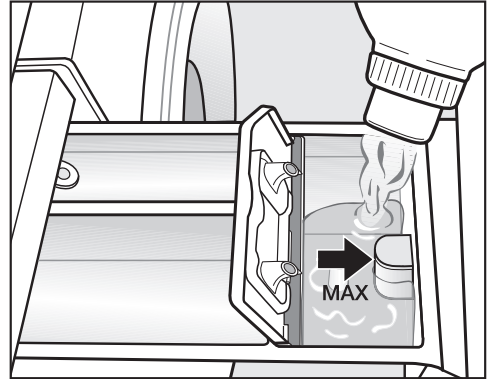

- Add fabric conditioner or liquid starch to the ⊗ compartment. **Do not exceed the maximum level mark.**

It will be automatically dispensed in the final rinse. At the end of the programme a small amount of water remains in the ⊗ compartment.

Starch can make the siphon tube sticky.

If starching frequently, thoroughly clean the dispenser compartment, especially the siphon tube, regularly.

5. Add detergent

Tips on dosing

Adjust the detergent dosage to the level of soiling of the laundry and the size of the load. Reduce the amount of detergent with smaller loads (e.g. reduce the amount of detergent by $\frac{1}{3}$ when washing a half load).

Too little detergent:

- Results in laundry not being cleaned properly and may cause it to become grey and hard to the touch over time.
- Can lead to a build-up of mould in the washing machine.
- Results in grease not being completely removed from the laundry.
- Can lead to limescale deposits on the heater elements.

Too much detergent

- Causes poor wash, rinse, and spin results.
- Causes higher water consumption as an extra rinse cycle is automatically activated.
- Is a greater burden on the environment.

Using liquid detergent with a pre-wash

Liquid detergent cannot be used for the main wash if the pre-wash has been selected.

Use TwinDos dispensing if you are activating the pre-wash.

Using detergent tablets or pods

Always put detergent tablets or pods directly in the drum with the laundry. They cannot be added via the detergent dispenser drawer.

See “Detergent” for further information.

5. Add detergent

CapDosing

If you selected CapDosing when setting the programme, detergent will be dispensed via the capsule for this wash programme.

Only one capsule can be selected per wash programme.

Three different types of capsule are available:

- ☼ = Fabric care (e.g. fabric conditioner, proofing agent)
- ☼ = Additives (e.g. detergent enhancer)
- ☼ = Detergent (for the main wash only)

Depending on the setting selected, the detergent, additive or fabric care agent will be dispensed via the capsule.

Each capsule contains the correct amount for one wash cycle.

Caps are available to order from Miele or from the Miele online shop (see the end of this booklet for contact details).

⚠ Capsules pose a health risk. The ingredients of capsules can be hazardous to health if they are swallowed or come into contact with skin. Keep capsules out of the reach of children.

Inserting a capsule

- Open the detergent dispenser drawer.

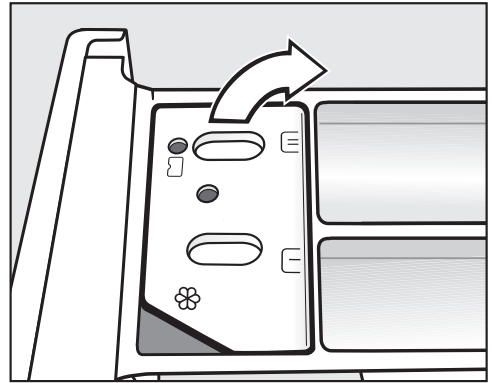

- Open the lid of the ☼/☼ compartment.

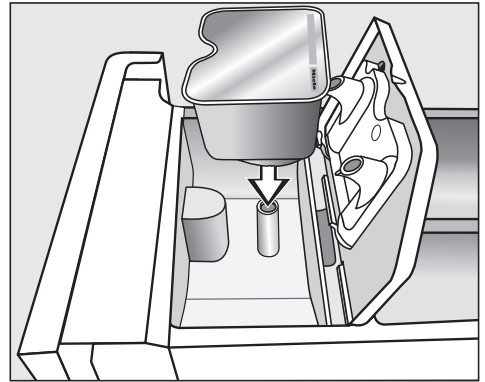

- Press the capsule in firmly.



5. Add detergent



- Close the lid and press it firmly shut.
- Close the detergent dispenser drawer.

The capsule is opened by the act of inserting it in the detergent dispenser drawer. The contents can run out of the capsule if you then remove it from the drawer before it is used. Dispose of opened capsules.

The wash programme will dispense the contents of the capsule at the correct time.

Water intake to the  compartment is solely via the capsule. Do not add any additional fabric conditioner to the  compartment.

- Remove the empty capsule at the end of the programme.

For technical reasons a small amount of water will remain in the capsule.

6. Starting the programme

Starting the programme

The programme can be started when the *Start/Stop* sensor control is flashing on and off.

- Touch the *Start/Stop* sensor control.

The door will lock and the programme will start.

The programme status will appear in the display.

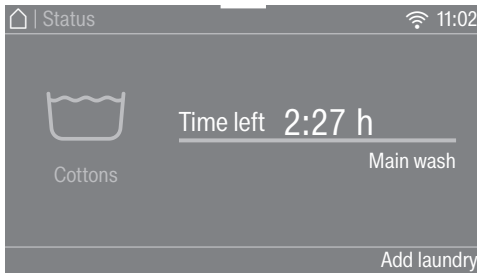

The washing machine will keep you updated on the programme status and the time remaining for the programme to run.

If a delay start period has been selected, this will count down in the display until the programme starts.

The drum lighting switches off once the programme has started.

Energy savings

After 10 minutes, the indicators dim. The *Start/Stop* sensor flashes slowly.

To reactivate the indicators:

- Touch the *Start/Stop* sensor (this does not have any effect on a programme that is running).

Adding laundry during a programme sequence (AddLoad)

Laundry can be added or removed at any time.

- Touch the *Add laundry* sensor control.

The following appears in the display:

⋮ Please wait

The programme will stop and the door will unlock.

The following appears in the display:

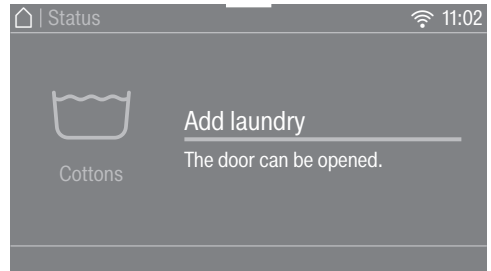

- Open the door and add or remove laundry.
- Close the door.
- Touch the *Start/Stop* sensor control.

The programme will continue.

Laundry cannot usually be added or removed if:

- The suds temperature is above 55 °C
- The water inside the drum is above a certain level

7. End of programme

End of programme

The door remains locked during the anti-crease phase and Finish/Anti-crease and Unlock with "Start/Stop" appear in the display.

- Touch the *Start/Stop* sensor control. The door will unlock.

The drum lighting will come on.

Tip: The door unlocks automatically at the end of the anti-crease phase.

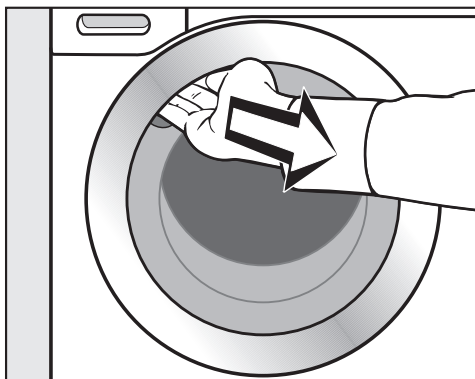

- Reach under the door grip and pull the door open.
- Remove the laundry.

Items left in the drum could discolour other items in the next wash or become discoloured themselves. Remove all items from the drum.

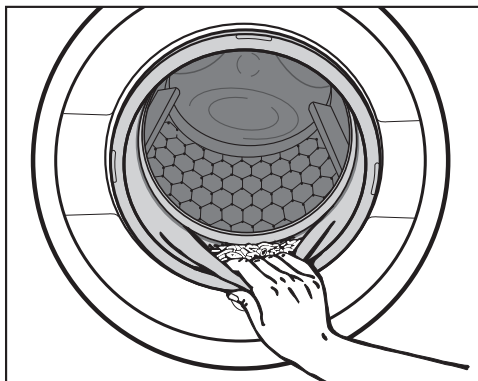

- Check the folds in the door seal for any small articles, e.g. buttons, which might be lodged there.

Tip: Leave the door slightly open to allow the drum to dry.

- Switch the washing machine off with the  control.
- If applicable, remove the used capsule from the detergent dispensing drawer.

Tip: Leave the detergent dispenser drawer slightly open to allow it to dry.

Spinning

Final spin speed in the programme

When a programme is selected, the optimum spin speed for this wash programme is shown in the display.

A faster spin speed can be selected for certain wash programmes.

The highest selectable spin speed is indicated in the table.

Programme	rpm
Cottons	1600
ECO 40-60	1600
Minimum iron	1200
Delicates	900
QuickPowerWash	1600
Automatic plus	1400
Woolens 	1200
Silks 	600
Express 20	1200
Shirts	900
Denim	900
Dark garments	1200
Sportswear	1200
Trainers	600
Outerwear	800
Proofing	1000
Down filled items	1200
Down duvets	1200
Pillows	1200
Cottons hygiene	1600
Curtains	600
First wash	1200
Separate rinse	1600
Starch	1200
Drain/Spin	1600
Cottons 	1400
Clean machine	600

Omitting the final spin (Rinse hold)

- Select the Rinse hold Extra.

If Rinse hold is selected, the laundry remains in the water following the final rinse cycle. This helps to prevent creasing if the laundry is not going to be removed from the drum immediately after the end of the programme.

Ending a programme with a spin cycle

The wash programme is set to the optimum spin speed. You can change the spin speed.

- Touch the Change spin speed sensor control.
- Select the desired spin speed.
- Touch the *Start/Stop* sensor control to start the final spin.

Ending a programme without a spin cycle

- Touch the Change spin speed sensor control.
- Select Spin speed 0 rpm (no spin).
- Touch the *Start/Stop* sensor control.

Interim spin

There is a spin cycle after the main wash and between the rinses. A reduction in the final spin speed will also reduce the interim spin speed as appropriate.

Omitting the interim spin and the final spin

- Touch the Spin speed sensor.
- Select the 0 rpm setting.



After the last rinse, the water will be pumped away and the anti-crease phase will switch in.

In some programmes an additional rinse is introduced with this setting.

Programme chart

Cottons		90 °C to cold	Max. load 9.0 kg
Items	Cotton, linen or mixed fibre fabric, e.g. table linen, underwear, T-shirts, etc.		
Tip	Where particularly high levels of hygiene are required, please select a temperature of 60 °C or higher.		
ECO 40-60			Max. load 9.0 kg
Items	For normally soiled cotton garments		
Tip	A laundry load consisting of mixed cottons that are intended for washing at 40 °C or 60 °C can be washed in the same wash cycle. This programme is the most efficient in terms of energy and water consumption for washing cottons.		
Note for test institutes:			
Test programme for compliance with EU legislation regarding ecodesign No. 2019/2023 and energy labelling in accordance with Regulation No. 2019/2014.			
TwinDos dispensing must be deactivated when carrying out comparison tests.			
Minimum iron		Cold to 60 °C	Max. load 4.0 kg
Items	Synthetic and mixed fibre textiles as well as easy care cotton		
Tip	Reduce the spin speed for fabric that creases easily.		
Delicates		Cold to 60 °C	Max. load 3.0 kg
Items	Delicate garments made from synthetic fibre, mixed fibre and viscose		
Tip	Deselect the spin for items which crease easily.		
QuickPowerWash		60 °C – 40 °C	Max. load 4.0 kg
Items	Lightly to moderately soiled garments which are also suitable for washing in the <i>Cottons</i> programme		
Tip	A special saturation process and wash rhythm ensure that the laundry is cleaned particularly quickly and thoroughly.		

Programme chart

Automatic plus		Cold to 40 °C	Max. load 6.0 kg
Items	Mixed loads of garments sorted according to colour which are suitable for the <i>Cottons</i> and <i>Minimum iron</i> programmes		
Tip	The wash parameters (e.g. water level, wash rhythm and spin speed) are adjusted automatically in this programme to ensure the best possible care and wash result for each item.		
Wollens 		Cold to 40 °C	Max. load 2.0 kg
Items	Wool or wool blend fabric		
Tip	Reduce the spin speed for fabric that creases easily.		
Silks 		Cold to 30 °C	Max. load 1.0 kg
Items	Silks and other handwashable fabrics with no wool content, e.g. satin, lace and silk		
Tip	Place tights, bras etc. in a laundry bag.		
Express 20		Cold to 40 °C	Max. load 3.5 kg
Items	Cotton garments that have hardly been worn or are only very lightly soiled		
Tip	The <i>Quick Extra</i> is activated automatically.		
Shirts		Cold to 60 °C	Max. load 1.0 kg/2.0 kg
Items	Shirts and blouses made of cotton and mixed fibre		
Tip	<ul style="list-style-type: none"> - Pre-treat collars and cuffs depending on the level of soiling. - Wash silk shirts and blouses in the <i>Silks</i> programme. - If the preset <i>Pre-ironing Extra</i> is switched off, the maximum load capacity is increased to 2.0 kg. 		

Programme chart

Denim		Cold to 60 °C	Max. load 3.0 kg
Tip	<ul style="list-style-type: none"> - Wash denim inside out. - Dark textiles often contain excess dye and should be washed separately several times before being included in a mixed load. Therefore, wash light and coloured items separately. - Close any zips, do up buttons, etc. before washing. 		
Dark garments		Cold to 60 °C	Max. load 3.0 kg
Items	Black and dark items made of cotton or mixed fibres		
Tip	Wash inside out.		
Sportswear		Cold to 60 °C	Max. load 3.0 kg
Items	Sportswear such as singlets and leggings as well as microfibre and fleece garments		
Tip	<ul style="list-style-type: none"> - Do not use fabric conditioner - Follow the instructions on the care label 		
Trainers		Cold to 40 °C	Max. 2 pairs of shoes
Items	Sport shoes only (not leather shoes)		
Tip	<ul style="list-style-type: none"> - Follow the instructions on the care label. - Coarse soiling should be brushed off first before washing. - Close Velcro fasteners. - Do not use fabric conditioner. - Use the drying basket for tumble drying. 		





Programme chart

Outerwear		Cold to 40 °C	Max. load 2.5 kg
Items	Performance outerwear (e.g. jackets and trousers) made from membrane fabric such as Gore-Tex®, SYMPATEX®, WINDSTOPPER®, etc.		
Tip	<ul style="list-style-type: none"> - Zip up or close any jackets with Velcro before washing. - Do not use fabric conditioner. - If required, these items can also be re-proofed using the <i>Proofing</i> programme. Proofing after each wash cycle is not recommended. 		
Proofing		40 °C	Max. load 2.5 kg
Items	Treating microfibre fabric, ski wear or table linen made from mainly synthetic fibres to provide a finish which is resistant to water and dirt		
Tip	<ul style="list-style-type: none"> - The items must be freshly laundered and spun or dried before proofing. - For best results, the items should be heat-treated afterwards. This can be achieved by drying them in the tumble dryer or ironing them. 		
Down filled items		Cold to 60 °C	Max. load 2.0 kg
Items	Jackets, sleeping bags, pillows and other items with down filling		
Tip	<ul style="list-style-type: none"> - Remove air from the laundry before washing to prevent an excessive build-up of foam. To do this either push the items into a narrow laundry bag to compress them or tie them together with a washable strap. - Follow the instructions on the care label 		

Programme chart

Down duvets		Cold to 60 °C	Max. load 2.5 kg 1 down duvet 2.20 m x 2.00 m
Items	Quilts, duvets and pillows with feather or down filling		
Tip	<ul style="list-style-type: none"> - Remove air from the laundry before washing to prevent an excessive build-up of foam. To do this either push the items into a narrow laundry bag to compress them or tie them together with a washable strap. - Follow the instructions on the care label 		
Pillows		Cold to 60 °C	2 pillows (40 x 80 cm) or 1 pillow (80 x 80 cm)
Items	Washable pillows with synthetic filling		
Tip	<ul style="list-style-type: none"> - Remove air from the laundry before washing to prevent an excessive build-up of foam. To do this either push the items into a narrow laundry bag to compress them or tie them together with a washable strap. - Follow the instructions on the care label 		
Cottons hygiene		90 °C to 60 °C	Max. load 9.0 kg
Items	Cotton or linen with direct skin contact or for items which have special hygiene requirements, e.g. underwear, bed linen, encasing products		
Tip	<ul style="list-style-type: none"> - Temperature holding times are longer than in the <i>Cottons</i> programme. - Follow the instructions on the care label. 		
Curtains		Cold to 40 °C	Max. load 2.0 kg
Items	Curtains specified as machine-washable by the manufacturer		
Tip	<ul style="list-style-type: none"> - To remove dust, the <i>Pre-wash Extra</i> is selected automatically. - For curtains which crease easily, reduce the spin speed or deselect the spin. - Remove weights from curtains 		

Programme chart

First wash		Cold to 40 °C	Max. load 2.0 kg
Items	New items made of cotton, towelling and polyester fabric		
Tip	Use this programme to wash any manufacturing residues out of new items.		
Separate rinse			Max. load 8.0 kg
Items	Rinsing hand-washed items		
Tip	Reduce the spin speed for items which crease easily.		
Starch			Max. load 8.0 kg
Items	Table cloths, serviettes and workwear that need starching		
Tip	<ul style="list-style-type: none"> - Reduce the spin speed for items which crease easily. - Laundry that is to be starched should be washed but not treated with fabric conditioner. 		
Drain/Spin			-
Tip	<ul style="list-style-type: none"> - Drain: Set the spin speed to 0 rpm - Make sure you select the appropriate spin speed 		
Cottons 		 / 	Max. load 9.0 kg
Use for	Normally soiled cotton garments.		
Notes	<ul style="list-style-type: none"> - These settings are the most efficient in terms of energy and water consumption for washing cottons. - With  the actual wash temperature reached will be lower than 60 °C although the wash performance is the same as with the Cottons 60 °C programme. 		
Note for test institutes:			
The test programme conforms to EN 60456.			

Programme chart

Maintenance

The washing machine has two maintenance programmes.

1. Clean machine for cleaning the washing machine.
2. Clean “TwinDos” for maintenance of TwinDos compartments ①/②. See “Cleaning and care – TwinDos maintenance” for more details.

Clean machine	85 °C	No load
<p>With frequent washing at low temperatures there is a danger of a build-up of bacteria in the washing machine.</p> <p>Cleaning the washing machine will significantly reduce bacteria, mould and biofilm, as well as prevent the build-up of unpleasant odours.</p>		
Tip	<ul style="list-style-type: none">- Optimum results can be achieved by using Miele’s IntenseClean washing machine cleaner. Alternatively, a universal powder detergent can be used.- Dispense the washing machine cleaner or universal detergent directly in the drum.- Do not load any laundry. The drum must be empty for the Clean Machine programme.	

Garment care label symbols

Washing	
The figure quoted in the bucket is the maximum temperature at which the garment can be washed.	
	Normal agitation
	Reduced agitation
	Much reduced agitation
	Hand wash
	Do not wash

Programme selection examples

Programme	Garment care label symbols
Cottons	
Minimum iron	
Delicates	
Woollens	
Silks	
Express 20	
Automatic plus	

Drying	
	Normal temperature
	Low temperature
	Do not tumble dry

Ironing	
	Approx. 200 °C
	Approx. 150 °C
	Approx. 110 °C
	Ironing with steam can cause irreversible damage.
	Ironing/rotary ironing prohibited

Professional cleaning	
	Dry clean only. The letters indicate the type of cleaning agent required.
	Wet cleaning
	Dry cleaning prohibited

Bleaching	
	Any oxidation bleach can be used
	Use oxygen bleach only
	Do not bleach

Extra options

You can use the extra options buttons to augment the wash programmes.

Quick

The programme duration is reduced. Mechanical action and energy usage are increased.

Water plus

The water level in the main wash and the rinses will be increased.

You can select by how much the water level is increased (see “Settings – Water plus level”).

Extra rinse

An extra rinse can be activated to achieve a better wash result.

SingleWash





For efficiently washing a very small load (< 1 kg) in a normal wash programme. The wash duration is reduced.

Please note the following advice:

- Use liquid detergent.
- Reduce the dosage to a maximum of 50 % of the amount quoted for a ½ load.

Pre-ironing

In order to reduce creasing, the laundry undergoes a smoothing process at the end of the programme. Reducing the maximum load by 50 % will achieve a better result. Follow the instructions in the display. Small loads achieve a better result.

The garments must be suitable for drying in a tumble dryer   and suitable for ironing  .

Pre-wash

For laundry with large amounts of dirt, e.g. dust and sand.

Soak

For heavily soiled and stained items with protein stains.





A duration of between 30 minutes and 6 hours in 30-minute increments can be selected for the soak process. See “Settings” for more information.

The factory default setting is 30 minutes.

Intensive

For hard-wearing laundry that is very heavily soiled. Cleaning efficiency is increased through more intense mechanical action and the application of more heat energy.

AllergoWash

This option should be used where high standards of hygiene are required. Energy consumption is increased to lengthen temperature holding times and water consumption is increased to improve rinsing efficiency. The items must be suitable for drying in a tumble dryer   and suitable for ironing  .

Extra gentle

Drum rotation and wash duration are reduced. Lightly soiled fabrics are washed more gently.

Extra quiet



This option reduces noise levels during the wash programme. Use this if you want to wash during quiet periods (for instance when children are sleeping). The final spin is automatically reduced to  (Rinse hold). The programme duration is increased.

Rinse hold

The laundry is not spun after the final rinse and remains in the rinse water. This helps to prevent creasing if the laundry is not going to be removed from the drum immediately after the end of the programme.

Not all Extras can be selected with every programme. If an Extra is not permitted for a wash programme it will not be shown in the display. See “Overview of wash programmes - Extras”.

Wash programme chart - Extras

	Quick	Water plus	Extra rinse	SingleWash	Pre-ironing
Cottons	●	●	●	●	●
ECO 40-60	-	-	-	-	-
Minimum iron	●	●	●	●	●
Delicates	●	●	●	●	●
QuickPowerWash	✓	-	-	●	●
Automatic plus	●	●	●	●	●
Woollens 	-	-	-	●	-
Silks 	-	-	-	●	-
Express 20	✓	-	-	-	●
Shirts	●	●	●	●	✓
Denim	●	●	●	●	●
Dark garments	●	●	●	●	✓
Sportswear	●	●	●	●	●
Trainers	-	●	-	-	-
Outerwear	●	●	●	-	-
Proofing	-	-	-	-	-
Down filled items	●	●	●	-	-
Down duvets	●	●	●	-	-
Pillows	●	●	●	-	-
Cottons hygiene	●	●	●	-	●
Curtains	●	●	●	-	●
First wash	-	●	●	●	●
Separate rinse	-	●	-	-	-
Starch	-	●	-	-	-
Cottons 	●	●	●	●	●

Wash programme chart - Extras





Pre-wash	Soak	Intensive	AllergoWash	Extra gentle	Extra quiet	Rinse hold
●	●	●	●	●	●	●
-	-	-	-	-	-	-
●	●	●	●	●	●	●
●	●	-	●	●	●	●
-	-	-	-	-	-	●
●	●	-	●	●	●	●
-	-	-	-	-	●	●
-	-	-	-	-	●	●
●	●	-	●	●	●	●
●	●	-	●	●	●	●
●	●	-	●	●	●	●
●	●	-	●	●	●	●
●	●	-	●	●	●	●
●	●	-	●	●	●	●
-	-	-	-	-	●	●
●	●	-	-	●	●	●
-	-	-	-	-	-	●
●	-	-	●	●	●	●
●	-	-	●	●	●	●
●	-	-	●	●	●	●
●	●	-	●	●	●	●
✓	-	-	●	●	●	●
-	-	-	-	●	●	●
-	-	-	-	-	-	●
-	-	-	-	-	-	●
●	●	●	●	●	●	●

● = can be selected

✓ = activated automatically

- = cannot be selected

Programme sequence

	Main wash		Rinses		Spinning
	Water level	Wash rhythm	Water level	Rinses	
Cottons		(A)		2-5 ^{1,2,3}	✓
ECO 40-60		(A)		2-3 ²	✓
Minimum iron		(B)		2-4 ^{2,3}	✓
Delicates		(C)		2-4 ^{2,3}	✓
QuickPowerWash		(A)		2	✓
Automatic plus		(A)(B)		2-4 ^{2,3}	✓
Woolens 		(E)		2	✓
Silks 		(E)		2	✓
Express 20		(A)		1	✓
Shirts		(C)		3-4 ³	✓
Denim		(B)		2-4 ^{2,3}	✓
Dark garments		(B)		3-5 ^{2,3}	✓
Sportswear		(C)		2-3 ³	✓
Trainers		(D)		2	✓
Outerwear		(C)		3-4 ³	✓
Proofing	-	(B)		1	✓
Down filled items ⁴		(C)		3-4 ³	✓
Down duvets		(C)		3-4 ³	✓
Pillows ⁴		(C)		3-4 ³	✓
Cottons hygiene		(A)		2-4 ^{2,3}	✓
Curtains		(C)		3-4 ³	✓
First wash		(B)		2-3 ³	✓
Separate rinse	-	-		2	✓
Starch		(B)	-	-	✓
Cottons 		(A)		2-5 ^{2,3}	✓

 = low water level

 = medium water level

 = high water level

Ⓐ = intensive rhythm

Ⓑ = normal rhythm

Ⓒ = sensitive rhythm

Ⓓ = ultra sensitive rhythm

Ⓔ = handwash rhythm

✓ = carried out

- = not carried out

This washing machine has fully electronic controls with automatic load control. The washing machine takes in the right amount of water required for the programme depending on the amount of laundry and its absorbency rate.



The programme sequences outlined in the chart are based on the basic programme with a full load.

The washing machine programme sequence display shows which stage of the programme has been reached.

Special features in the programme sequence

Anti-crease:

At the end of the programme the drum continues to turn at intervals for up to 30 minutes to help prevent creasing.

Exception: There is no anti-crease phase in the *Woolens*  and *Silks*  programmes.

The door can be opened at any time during the anti-crease phase.

¹⁾ If a temperature of 60 °C or higher is selected, two rinses are carried out. If a temperature of less than 60 °C is selected, three rinses are carried out.

²⁾ An additional rinse is carried out if:

- there is too much foam in the drum
- a spin speed lower than 700 rpm has been selected.

³⁾ An additional rinse is carried out if:

- The Extra rinse Extra has been selected

⁴⁾ Run-up to spin: A run-up to spin is carried out before the wash process begins to deflate down-filled items. Subsequent water intake for the main wash is through compartment .

Programme sequence

PowerWash

PowerWash is a washing technique developed by Miele. It is activated in the following programmes:

- Cottons (with small and medium load sizes)
- ECO 40-60 (with small and medium load sizes)
- Minimum iron
- Shirts
- Automatic plus
- Delicates
- Cottons  (with small and medium load sizes)

How it works

Conventional washing techniques wash with more water than the laundry can absorb. This total volume of water needs to be heated.

The PowerWash washing technique only uses slightly more water than the laundry can absorb. The water which has not been absorbed by the laundry heats up the drum and the laundry and is sprayed into the laundry over and over again. This reduces energy consumption.

Activation

PowerWash is activated **automatically** in the programmes listed above.

PowerWash is deactivated if:

- The selected final spin speed is less than 600 rpm
- CapDosing (☹, ☹) has been selected for the main wash
- The wash temperature is higher than 60 °C
- Extras such as *Pre-wash* or *Water plus* have been selected
- A large load is being washed in the *Cottons* programme

Special features

- Drenching phase

The washing machine will spin a few times at the beginning of the programme. During spinning, the water discharged is sprayed back into the laundry in order to achieve optimum moisture penetration.

The optimum water level is set at the end of the drenching phase. If necessary, the washing machine will pump water away or take in a little more fresh water.

- Noises during the heating phase

Unusual bubbling noises can occur while the laundry and the drum are being heated.



Changing the programme sequence

Changing a programme (safety lock)

A programme, temperature, spin speed or selected options cannot be changed once the machine has been successfully started. This prevents the machine being operated unintentionally, e.g. by children.

If the washing machine is switched off during active programme operation, the standby function does not switch the washing machine off completely after 15 minutes. Safety functions continue to be active because there may still be water inside the drum.

Interrupting a programme

- Switch the washing machine off with the  control.
- Switch the washing machine back on with the  control to continue with the same programme.

Cancelling a programme

You can cancel a wash programme at any time after it has started.

- Touch the *Start/Stop* sensor.

The following will appear in the display:

 Cancel the programme?

- Select Yes.

The following will appear in the display:

Programme cancelled.

The suds will be pumped away.

- Wait until the door unlocks.
- Pull open the door.
- Remove the laundry.

Selecting another programme

- Close the door.
- Select the programme you want.
- Add detergent to the detergent dispenser drawer, if necessary.
- Touch the *Start/Stop* sensor.

The new programme will begin.

Favourite programmes

Creating favourites

You can save your own customised wash programmes under names of your choice.

Option 1

- The main menu must be visible in the display. Touch the **Favourites** sensor control.

The display will change to show the **Favourites** menu.

Touch the **Create** sensor control.

The display will change to the **Create Favourites** menu.

- Select the programme you want to use.
- Select all the programme settings you want.
- Then select **Save**.
- Enter a name.

Option 2

You can save a programme which has been selected as a **Favourite** programme before you start it.

- Before the programme starts, touch the ☆ **Save** sensor control.
- Enter a name.

If 12 **Favourites** have already been saved, the **Create** or ☆ **Save** sensor control will not be visible. Delete an existing **Favourite** if you wish to create a new one.

To enter a name

It is best to select short, memorable names.

- Touch the letters or characters you want.
- Confirm with the **Save** sensor.

The wash programme will then be saved to the **Favourites** programme list.

To change a Favourite programme

You can rename, delete or move a **Favourite** programme.

- Select **Favourites** from the main menu.
- Touch the **Favourite** programme that you wish to change until the **Context** menu opens.
- Select **Rename**, **Delete** or **Move**.

The wash assistant helps you with loads consisting of items with different care instructions. The washing machine will use the list of items to put together a suitable wash programme.

- Scroll to the second page in the main menu.
- Touch the **Washing assistant sensor control**.

A list of items will appear.

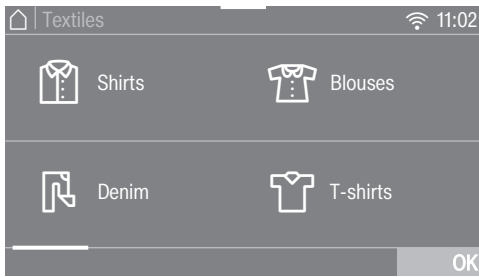

- Touch the appropriate sensor control for your item of laundry.

The item selected will be highlighted orange. You can select several items.

With some items, helpful information will also appear in the display when they are selected.

- Confirm with the **OK** sensor control.
- Follow the instructions in the display.

A summary of the selected parameters will then appear in the display.

- Confirm with the **OK** sensor control or select **Change** if you would like to make any changes.

The programme which has been tailored to your laundry is ready to start.

Tip: You can add individual programme settings, e.g. *Extras*, before you start the programme.

Timer



The Timer can be used to set the time you wish a programme to finish or start at. The programme start can be delayed by up to 24 hours.

Setting the timer

- Touch the  Timer sensor.
- Select the Finish at or Start at option.
- Set the hours and the minutes with the OK sensor.

Changing the timer

The selected times for the timer can be changed before the programme starts.

- Touch the  or  sensor.
- Change the specified time and confirm with the OK sensor.

Deleting the timer

The selected time for the timer can be changed before the programme starts.

- Touch the  or  sensor.

The selected time for the timer appears in the display.

- Touch the Delete sensor.
- Confirm with the OK sensor.

The selected time for the timer is now deleted.

To start the timer

- Touch the *Start/Stop* sensor.

The door will lock and the time until the programme starts will appear in the display.

After the programme has started, the selected time can only be changed or cancelled by interrupting the programme.

The programme can now be started.

- Touch the Start immediately sensor.

SmartStart

The *SmartStart* function lets you define a period of time during which your washing machine will start automatically. The appliance will start on receipt of a signal, e.g. from your energy supplier, that indicates that the electricity tariff is particularly economical.

This function is active when the SmartGrid setting is switched on.

The timeframe can be defined between 1 minute and 24 hours. During this period, the washing machine waits for the signal from the energy supplier. If no signal is sent during the defined period, the washing machine starts the wash programme.

Setting the timeframe

If you have activated the SmartGrid function in Settings, SmartStart by or SmartFinish by will appear in the display instead of Start at or Finish at when you touch the ⊕ Timer sensor (see “Settings – SmartGrid”).

The procedure for setting this is the same as for setting the time for Delay start.

- Now set the time you want and confirm with the OK sensor.
- Touch the *Start/Stop* sensor to start the wash programme with *SmartStart*.

The selected programme will start automatically, as soon as the energy provider has sent the signal, or the latest calculated start time has been reached.

The procedure for changing or deleting the *SmartStart* function is the same as described for the Delay start function.

Detergent

The correct detergent

All detergents produced for automatic washing machines are suitable. Follow the manufacturer's instructions and dosage recommendations on the packaging.

For users in Asia:

please use a low foaming detergent suitable for use in front-loading machines

The right amount to dispense will depend on the following:

- the soiling level of the load
- the quantity of the laundry
- the water hardness level.
Check with your local water supplier if you do not know the hardness level in your area.

Water softeners

A water softener can be used to cut down on the use of detergents in areas with water hardness levels II and III. Dispense according to the amount specified on the packaging. First add detergent and then the water softener.

You can then use the recommended amount of detergent for water hardness level I.

Water hardness levels

Hardness scale	Hardness level in mmol/l	German scale °d
I (soft)	0 – 1.5	0 – 8.4
II (medium)	1.5 – 2.5	8.4 – 14
III (hard)	above 2.5	above 14

Dispensing aids

Use dispensing aids, (e.g. balls) if these are supplied with the detergent, particularly when using liquid detergent.

Refill packs of detergent

When purchasing detergent buy refill packs wherever possible. This helps reduce the amount of waste packaging.

Fabric conditioner and liquid starch

Fabric conditioner

makes garments soft to handle and helps prevent static cling when tumble drying.

Starch



stiffens and gives body to items of laundry, e.g. shirts, tablecloths and bed linen.

Adding fabric conditioner or liquid starch separately

Prepare the starch in accordance with the manufacturer's instructions on the packaging.

Tip: When adding fabric conditioner, activate the *Water plus Extra*.

Dispensing via the detergent dispenser drawer

- Add fabric conditioner to the  compartment or insert the appropriate capsule.
- Add liquid starch to the  compartment and powder or viscous starch to the  compartment.
- Select the *Separate rinse* programme.
- Change the spin speed if necessary.
- If using a capsule, touch the *CapDosing* sensor and activate the *Cap*.
- Touch the *Start/Stop* sensor.

TwinDos dispensing

One of the automatic dispensing containers must be filled with fabric conditioner.

- Select the *Separate rinse* programme.
- Change the spin speed if necessary.
- Touch the *TwinDos* sensor.
- Touch the *On* sensor to activate *TwinDos*.
- Touch the *Start/Stop* sensor.

Colour run and dye removers/dyes

 Damage due to colour run/dye removers.

Colour run and dye removers can cause corrosion in the washing machine.

Do not use colour run or dye removers in this washing machine.







Dyes suitable for use in domestic washing machines can be used. However, please note that the salt used in the dyeing process can cause corrosion to stainless steel components in the machine if you use dye frequently. Always follow the dye manufacturer's instructions carefully.

When using the machine to dye fabric it is essential to select the *Water plus Extra*.



Detergent

Recommended Miele detergents

Miele detergents have been specially designed for day-to-day use in Miele washing machines. See “Detergents and care products” for more information about these detergents.



	Miele UltraPhase 1 and 2	Miele single-use capsules		
				
Cottons	✓	-	✓	✓
ECO 40-60	✓	-	✓	✓
Minimum iron	✓	-	✓	✓
Delicates	✓	✓	✓	-
QuickPowerWash	✓	-	-	-
Automatic plus	✓	-	✓	✓
Woolens 	-	✓	-	-
Silks 	-	✓	-	-
Express 20	✓	-	✓	-
Shirts	✓	-	✓	✓
Denim	✓	-	✓	-
Dark garments	✓	✓	✓	-
Sportswear	-	✓	-	-
Trainers	✓	-	-	✓
Outerwear	-	✓	-	-
Down filled items	-	✓	-	-
Down duvets	-	✓	-	-
Pillows	✓	-	-	-
Cottons hygiene	✓	-	✓	✓
Curtains	✓	-	-	✓
First wash	✓	-	✓	-
Separate rinse	-	-	✓	-
Cottons 	✓	-	✓	✓

- ✓ Recommendation
- No recommendation

-  Specialist detergents (e.g. WoolCare)
-  Fabric care (e.g. fabric conditioner)
-  Additive (e.g. booster)

Recommended detergents in accordance with Directive (EU) Nr. 1015/2010

The recommendations apply to the temperature ranges given in the Programme chart.

	Universal	Coloureds	Delicates and woollens	Specialist
	detergent			
Cottons	✓	✓	-	-
ECO 40-60	✓	✓	-	-
Minimum iron	-	✓	-	-
Delicates	-	-	✓	-
QuickPowerWash	✓	✓	-	-
Automatic plus	-	✓	-	-
Woollens 	-	-	✓	✓
Silks 	-	-	✓	✓
Express 20	-	✓ ¹	-	-
Shirts	✓	✓	-	-
Denim	-	✓ ¹	-	✓
Dark garments	-	✓ ¹	-	✓
Sportswear	-	-	✓	✓
Trainers	-	✓	-	-
Outerwear	-	-	✓	✓
Down filled items	-	-	✓ ¹	✓
Down duvets	-	-	✓ ¹	✓
Pillows	-	-	✓ ¹	✓
Curtains	✓ ²	-	-	✓
First wash	-	✓	-	-
Cottons 	✓	✓	-	-
Clean machine	✓ ²	-	-	✓

✓ Recommended

- Not recommended

1) Liquid detergent

2) Powder detergent

Replacing the TwinDos cartridge

A message will appear in your washing machine display if a detergent cartridge is empty.

Preparing the cartridge

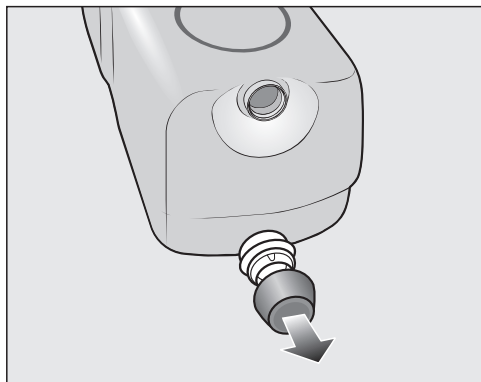

- Remove the cover cap from the cartridge.

or

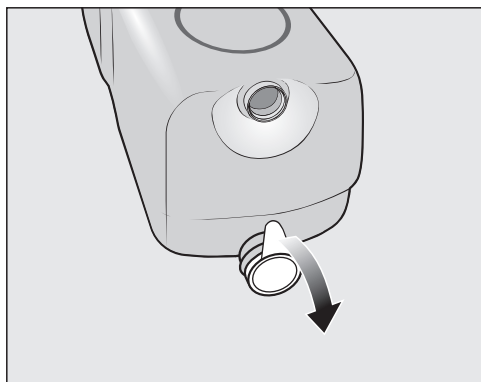

- Remove the film seal from the cartridge completely.

 Risk of damage from film seal
If the film seal is not removed completely, leaks can occur in the TwinDos system.

Remove the film seal from the suction port on the cartridge completely before inserting the new cartridge.

Replacing the cartridge

- Switch on the washing machine.

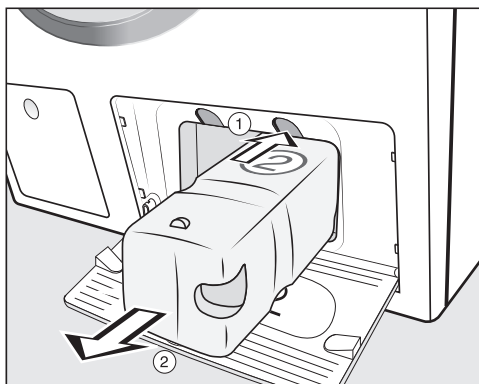

① To release the lock, press the yellow button above the cartridge.

② Pull out the cartridge.

- Insert a new cartridge.
- Confirm the messages in the display.

The counter is set to 0.

Cleaning the external casing and the control panel

⚠ Risk of electric shock!
Mains voltage is present when the washing machine is switched off
Disconnect the machine from the electricity supply before cleaning or maintenance.

⚠ Risk of damage due to ingress of water.
The pressure of a water jet can cause water to get into the washing machine, resulting in damage to components.
Do not spray the washing machine with a water jet.

- Clean the casing and control panel with a mild cleaning agent or soap and water and dry both with a soft cloth.
- The drum can be cleaned using a suitable stainless steel cleaning agent following the manufacturer's instructions on the packaging.

⚠ Damage caused by cleaning agents.
Solvent based cleaning agents, abrasive cleaners, glass cleaners or multi-purpose cleaning agents can cause damage to plastic surfaces and other parts.
Do not use any of these cleaning agents.

Cleaning the detergent dispenser drawer

Washing at low temperatures and the use of liquid detergent can lead to a build-up of bacteria in the detergent dispenser drawer.

- Clean the entire drawer at regular intervals for hygiene reasons, even if you are using the TwinDos system exclusively.

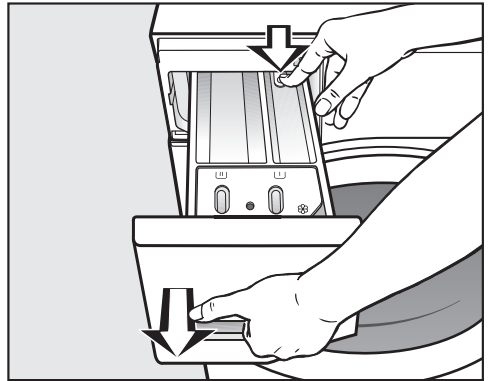

Removing the detergent drawer



- Pull out the detergent dispenser drawer until a resistance is felt. Press down the release button and at the same time pull the drawer right out of the machine.
- Clean the detergent drawer with warm water.

Cleaning and care

Cleaning the siphon and the compartment channel

Liquid starch results in clogging. If clogged, the siphon in the   compartment will not work and the compartment can overflow.

Clean the siphon particularly thoroughly after using liquid starch a few times.

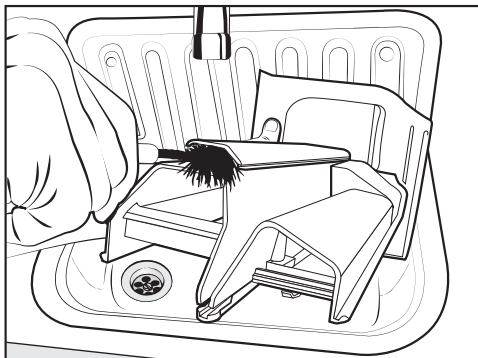

- Clean the fabric conditioner channel using a brush and warm water.

Cleaning the detergent dispenser drawer compartment

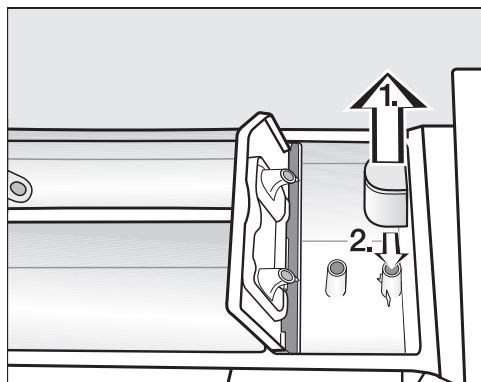

1. Remove the siphon from  compartment and clean under warm running water. Clean the siphon tube in the same way.
2. Replace the siphon.

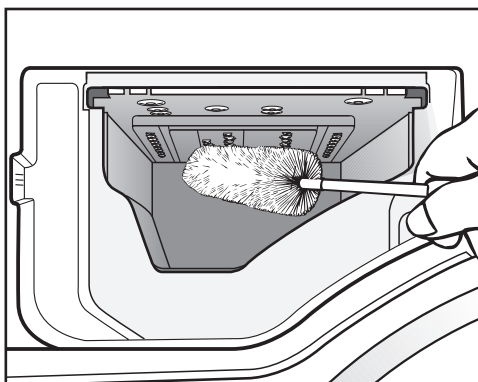

- Use a bottle brush to remove detergent residues and limescale from the jets inside the detergent dispenser drawer compartment.
- Refit the detergent drawer.

Tip: To assist drying, leave the detergent drawer slightly open.

Cleaning the drum (Hygiene info)

Washing at low temperatures and/or using liquid detergent can cause bacteria and unpleasant odours to build up in the washing machine. Use the **Clean machine programme** to clean the machine. Run this programme regularly or at the latest when the Hygiene info: Select "Maintenance" and run the "Clean machine" programme. message appears in the display.

TwinDos maintenance

 Damage resulting from dried laundry detergent.

If the system has not been used for a long time (more than two months), detergent in the hoses can become viscous or dry out. The hoses can become blocked and would then need to be cleaned by a service technician.

Clean the TwinDos system.

To clean the system, you either need a "TwinDosCare" cleaning cartridge or a TwinDos refill cartridge, both of which are available to purchase from www.shop.miele.com.

The washing machine has a cleaning programme for the TwinDos system. Running the cleaning programme will clean the hoses inside the washing machine.

Starting the maintenance programme

- Switch on the washing machine.
- Scroll to the second page in the main menu.
- Touch the Maintenance sensor.

The display will then change to show the *Maintenance* menu.

- Select Clean "TwinDos".
- Touch the sensor for the container you want to clean.
- Confirm Start Maintenance programme? with the Yes sensor.
- Follow the instructions in the display.

This cleans the hoses. The TwinDos system can then be used again at any time.

Cleaning the compartment

Detergent residue can cause clogging.

- Use a damp cloth to clean the compartment interior when you change the cartridge or container.

Cleaning and care

Cleaning the water inlet filter

The washing machine has a filter to protect the water inlet valve. The accessible filter in the union at the open end of the inlet hose should be checked every six months or so, or more often if there are frequent interruptions to the water supply.

- First turn off the stopcock.
- Unscrew the inlet hose from the stopcock.

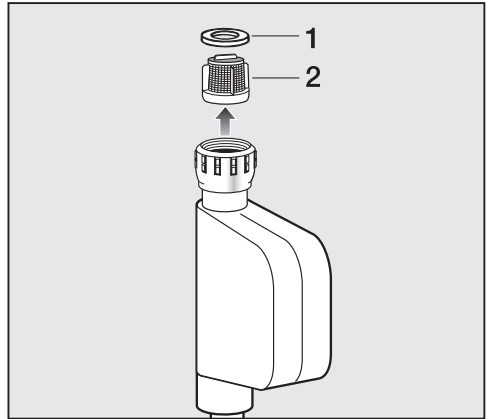

- Remove the rubber seal **1** from the recess.
- Using pointed pliers, take hold of the plastic filter bar **2** and remove it. Clean the plastic filter.
- Put the filter and seal back in the reverse order and reconnect the hose.



Turn on the stopcock and check the connection is watertight. If water drips out, tighten the connection.

The filter **must** be put back in place after cleaning.

Many malfunctions and faults that can occur in daily operation can be easily remedied. Time and money will be saved because a service call will not be needed.





The following guide may help you to find the reason for a malfunction or a fault, and to correct it.

The programme does not start

Problem	Cause and remedy
<p>The display remains dark, and the Start/Stop button indicator light does not come on.</p>	<p>There is no power to the machine.</p> <ul style="list-style-type: none"> ■ Check whether the mains plug is plugged in and switched on. ■ Check whether the fuse or circuit breaker has tripped. <hr/> <p>The washing machine has switched off automatically to save energy.</p> <ul style="list-style-type: none"> ■ Switch it back on with the  button.
<p>The display prompts you to enter a code.</p>	<p>Access via a code has been activated.</p> <ul style="list-style-type: none"> ■ Enter the code and confirm the entry. Deactivate the code if you do not wish this message to appear in the display the next time the machine is switched on.
<p>The following appears in the display:  The door will not lock. Call Service.</p>	<p>The door is not closed properly. The door lock could not engage.</p> <ul style="list-style-type: none"> ■ Close the door again. ■ Start the programme again. <p>If the fault message appears again, contact Miele.</p>

Problem solving guide

Fault message after a programme has been interrupted.

Problem	Cause and remedy
 Drainage fault. Clean drain filter and pump. Check the drain hose.	The water outlet is blocked or restricted. The drain hose has been fixed too high. <ul style="list-style-type: none">■ Clean the drain filter and the drain pump.■ The maximum delivery head is 1.0 m.
 Water intake fault. Open the stopcock.	The water intake is blocked or restricted. <ul style="list-style-type: none">■ Check whether the stopcock has been properly opened.■ Check whether the intake hose is kinked.■ Check whether there is sufficient water pressure.
	The filter in the water intake is blocked. <ul style="list-style-type: none">■ Clean the filter.
 Fault F. If restart fails, call Service.	There is a fault. <ul style="list-style-type: none">■ Disconnect the washing machine from the mains electricity supply, either by switching it off at the wall socket and withdrawing the plug, or by disconnecting it at the circuit breaker.■ Wait at least 2 minutes before reconnecting the washing machine to the mains electricity supply.■ Then switch the washing machine on again.■ Restart the programme. If the fault message appears again, contact Miele.
 Waterproof system activated. Close stopcock and call Service	The water protection system has reacted. <ul style="list-style-type: none">■ Close the stopcock.■ Call Service.

To switch off the fault messages: Switch the washing machine off with the  button.

Fault message at the end of a programme

Problem	Cause and remedy
i Check dosage	Excessive foam has built up during washing. <ul style="list-style-type: none">■ Check the amount of detergent dispensed.■ With automatic detergent dispensing, check the dosage amount set.■ Observe the instructions on the detergent packaging and the degree of soiling of the laundry.■ If necessary, reduce the dispensing quantity by increments of 10 %.
i Hygiene info: Select "Maintenance" and run the "Clean machine" programme.	A wash programme using a temperature above 60 °C has not been run for a long time. <ul style="list-style-type: none">■ In order to prevent bacteria and unpleasant odours building up in the washing machine, run the <i>Clean machine</i> programme using Miele machine cleaner or a universal powder detergent.

The messages will appear at the end of the programme and when the washing machine is switched on and need to be confirmed with the OK sensor.

Problem solving guide

Fault message at the end of a programme

Problem	Cause and remedy
i Intensive flow: Clean the filter and jet or remove foreign objects from the pump housing.	<p>The pumps are dirty.</p> <ul style="list-style-type: none">■ Clean the pumps as described in “Problem solving guide . . .”, Opening the door in the event of a blocked drain outlet and/or power cut”.■ Restart the programme after cleaning.
	<p>The jet in the top of the door ring is blocked with fluff.</p> <ul style="list-style-type: none">■ Remove the fluff with your finger. Do not use any sharp or pointed tools to do this.■ Restart the programme after cleaning.
	<p>If the fault message appears again, contact Miele. The washing machine can still be used but with reduced functionality.</p>
i Align the machine. Laundry not properly spun	<p>The Pre-ironing Extra which runs at the end of the programme could not be carried out properly.</p> <ul style="list-style-type: none">■ Check whether the washing machine is aligned correctly as described in “Installation – Levelling the machine”.■ Check whether the maximum delivery head of 1 m has been exceeded.
	<p>If the fault message appears again, contact Miele. The washing machine can still be used but with reduced functionality.</p>

The messages will appear at the end of the programme and when the washing machine is switched on and need to be confirmed with the *OK* sensor.

Messages or faults with the TwinDos system

Problem	Cause and remedy
<p>i Only a few more wash cycles can be run. Please order more detergent for compartment ①.</p>	<p>The detergent in the cartridge is running low. There is sufficient left for approx. 4 to 8 wash programmes.</p> <ul style="list-style-type: none"> ■ Order a new cartridge.
<p>i "TwinDos" ① is empty. Check wash results.</p>	<p>The cartridge is empty.</p> <ul style="list-style-type: none"> ■ Replace the cartridge. ■ Check whether the laundry is clean. If it is not, there may not have been enough detergent. Wash the laundry again if necessary.
<p>i Use "TwinDos" or carry out "TwinDos" Maintenance in the "Maintenance" menu. See the operating instruction manual for more information.</p>	<p>TwinDos or automatic dispensing via compartment ① and/or ② has not been used for a long time.</p> <ul style="list-style-type: none"> ■ Use TwinDos for one of your next loads. ■ Carry out the TwinDos maintenance programme as described in "Cleaning and care - TwinDos maintenance".
<p> "TwinDos" Maintenance for compartment ① must be started in the "Maintenance" menu. See the operating instruction manual for more information.</p>	<p>TwinDos or automatic dispensing via compartment ① and/or ② has not been used for a long time. It is possible that detergent has dried inside the hoses.</p> <ul style="list-style-type: none"> ■ Carry out the TwinDos maintenance programme immediately as described in "Cleaning and care - TwinDos maintenance".

The messages shown on this page are examples. They may differ depending on whether they refer to compartment ① or ②.

The messages will appear at the end of the programme and when the washing machine is switched on and need to be confirmed with the OK sensor.

Problem solving guide

Messages or faults with the TwinDos system

Problem	Cause and remedy
A new detergent cartridge has been inserted, but the cartridge is identified as empty when the machine is switched on.	The washing machine was switched off when the detergent cartridge was replaced. <ul style="list-style-type: none">■ Switch on the washing machine.■ Remove the detergent cartridge and then reinsert it into the compartment. The counter is set to 0.
There are dark specks in the liquid detergent.	Mould has developed in the detergent. <ul style="list-style-type: none">■ Pour the liquid detergent out of the container and then clean the container thoroughly.
No detergent and/or fabric conditioner was dispensed.	Automatic dispensing has not been activated. <ul style="list-style-type: none">■ Touch the TwinDos sensor before running the next programme. Automatic dispensing will be activated.
	No detergent/fabric softener was dispensed although automatic dispensing was activated. <ul style="list-style-type: none">■ Try again.■ If detergent is still not dispensed, call Miele.

General problems with the washing machine

Problem	Cause and remedy
<p>The washing machine smells.</p>	<p>Hygiene info was ignored. A wash programme using a temperature above 60 °C has not been run for a long time.</p> <ul style="list-style-type: none"> ■ In order to prevent bacteria and unpleasant odours building up in the washing machine, run the <i>Maintenance wash</i> programme using Miele machine cleaner or a universal powder detergent.
	<p>The door and the detergent dispenser drawer were left shut after washing.</p> <ul style="list-style-type: none"> ■ Leave the door and the detergent dispenser drawer slightly open to allow them to dry.
<p>The machine shakes during the spin cycle.</p>	<p>The machine feet are not level.</p> <ul style="list-style-type: none"> ■ Level the machine and adjust the feet correctly.
<p>The laundry has not been spun properly and is still wet.</p>	<p>The machine detected an imbalance during the final spin cycle and reduced the spin speed automatically.</p> <ul style="list-style-type: none"> ■ Include both large and small items in the load as this will give better distribution during spinning.
<p>Strange pump noises can be heard.</p>	<p>This is not a fault. These slurping noises occur at the end of the pump sequence as a normal part of operation.</p>
<p>The drum lighting does not come on.</p>	<p>The drum lighting goes out automatically after 5 minutes.</p> <ul style="list-style-type: none"> ■ Open the pull-down menu from the overview menu and then touch the  sensor control.
	<p>The drum lighting is faulty.</p> <ul style="list-style-type: none"> ■ Call the Miele Customer Service Department.

Problem solving guide

General problems with the washing machine

Problem	Cause and remedy
<p>Large amounts of detergent residue remain in the detergent dispenser drawer.</p>	<p>The water pressure is too low.</p> <ul style="list-style-type: none"> ■ Clean the water inlet filter. ■ It may be useful to select the <i>Water plus extra</i> option.
	<p>Powder detergent used in conjunction with water softeners tends to become sticky.</p> <ul style="list-style-type: none"> ■ In future, add washing powder into the dispenser drawer first, and then add the water softener.
<p>Fabric conditioner is not completely dispensed or too much water remains in the  compartment.</p>	<p>The siphon tube is not correctly positioned or is clogged.</p> <ul style="list-style-type: none"> ■ Clean the siphon, see “Cleaning and care - Cleaning the detergent dispenser drawer”.
<p>At the end of the programme there is still liquid in the capsule.</p>	<p>The small pipe in the detergent dispenser drawer onto which the capsule is placed is blocked.</p> <ul style="list-style-type: none"> ■ Clean the small pipe.
	<p>This is not a fault. For technical reasons a small amount of water will remain in the capsule.</p>
<p>There is water next to the capsule in the fabric conditioner compartment</p>	<p>CapDosing was not activated or an empty capsule was not removed at the end of the last wash programme.</p> <ul style="list-style-type: none"> ■ Make sure that you remember to activate CapDosing the next time you insert a capsule. ■ Remove and dispose of the empty capsule at the end of each programme.
	<p>The small pipe in the detergent dispenser drawer onto which the capsule is placed is blocked.</p> <ul style="list-style-type: none"> ■ Clean the small pipe.

An unsatisfactory wash result

Problem	Cause and remedy
Liquid detergent does not give the required result.	<p>Liquid detergents usually contain no bleaching agents. They do not remove fruit, coffee and tea stains.</p> <ul style="list-style-type: none">■ Use the Miele 2 Phase System. The targeted addition of UltraPhase 2 during the wash process removes stains effectively.■ Use a general purpose powder detergent containing a bleaching agent.
White residues which look like powder detergent are seen on dark textiles after washing.	<p>The detergent contained compounds (zeolites) to aid water softening which are not soluble in water. These have ended up on the laundry.</p> <ul style="list-style-type: none">■ Try and brush off the residues with a soft brush once the laundry is dry.■ Wash dark textiles using a detergent which contains no zeolites. Liquid detergents usually contain no zeolites.■ Use the <i>Dark garments</i> programme.
Grey, greasy particles cling to washed laundry.	<p>Insufficient amounts of detergent were used to break down the particles of grease in heavily soiled laundry.</p> <ul style="list-style-type: none">■ Use more detergent.■ Before washing the next load, run the <i>Clean machine</i> using Miele machine cleaner or a powder detergent.

Problem solving guide

The door will not open

Problem	Cause and remedy
The door cannot be pulled open during a programme.	<p>The door is locked during a programme.</p> <ul style="list-style-type: none">■ Touch the <i>Start/Stop</i> sensor to cancel the programme. <p>The programme is cancelled, the door will unlock and you will be able to pull it open.</p> <hr/> <p>There is still water in the drum and the machine is unable to drain.</p> <ul style="list-style-type: none">■ Clean the drain filters and the drain pump as described in “Opening the door in the event of a blocked drain outlet and/or power failure”.
Comfort cooling appears in the display after a programme has been cancelled.	<p>To protect the user against scalding, the door cannot be opened if the suds temperature is higher than 55 °C.</p> <ul style="list-style-type: none">■ Wait until the temperature in the drum has decreased and the message has gone out in the display.
The following appears in the display:  The door lock is jammed. Call Service.	<p>The door lock has jammed.</p> <ul style="list-style-type: none">■ Call Service.

Opening the door in the event of a blocked drain outlet and/or power cut

- Switch off the washing machine.



- Open the access panel for the drain pump.

Blocked drain outlet

If the drain outlet is blocked, there may be a large quantity of water left behind in the washing machine.

 Risk of scalding due to hot suds. Escaping suds will be hot if laundry has been washed at high temperatures! Carefully allow all suds to drain off.

Draining the washing machine

Remove the drain filter, though not completely.

- Place a suitable container under the access panel, e.g. a universal oven tray.

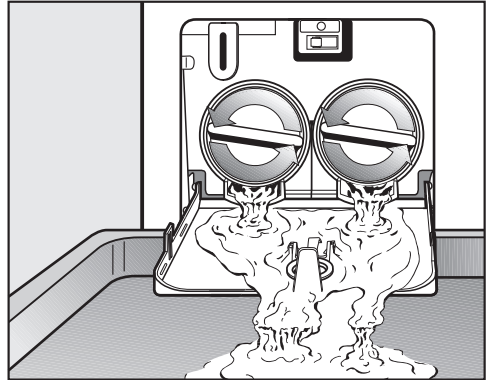

- Slowly unscrew the drain filters to let the water out.
- Tighten the drain filters back up again if you need to interrupt the flow of water.

Once the flow of water ceases:

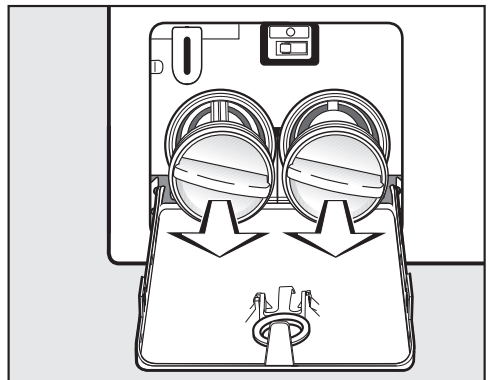

- Remove the drain filters completely.

Problem solving guide

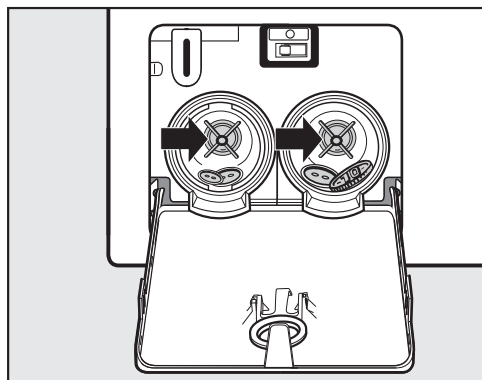

- Clean the drain filters thoroughly.
- Remove any foreign objects (e.g. buttons, coins, etc.) and clean the interior. Turn the impellers by hand to check that they rotate freely.

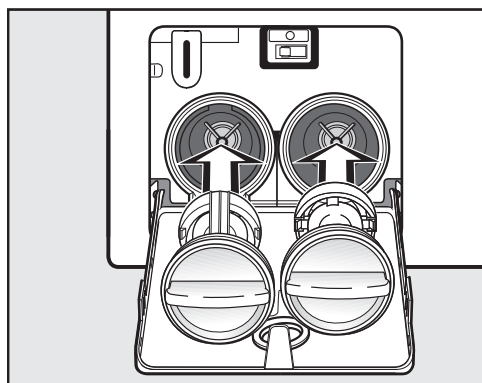

- Replace the drain filters correctly (on the right and left) and tighten them securely.
- Close the drain pump access panel.

Open the door

⚠ Danger of injury due to rotating drum!

Reaching into a moving drum is extremely dangerous.

Always make sure that the drum is stationary before reaching in to remove laundry.

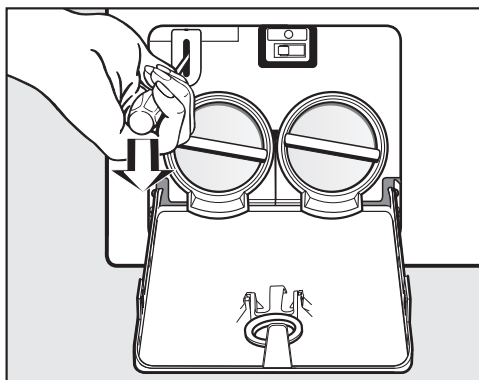

- Use a screwdriver to unlock the door.
- Pull open the door.

⚠ Risk of water damage.

Make sure the drain filters are securely tightened. Otherwise there is a risk of water leakage during use.

Replace the drain filters correctly and tighten them securely.

Contact in the event of a fault

In the event of any faults which you cannot remedy yourself, please contact your Miele dealer or the Miele Customer Service Department.

You can book a Miele Customer Service Department call-out online at www.miele.com/service.

Contact information for the Miele Customer Service Department can be found at the end of this document.

Please quote the model identifier and serial number of your appliance (Fabr./SN/Nr.) when contacting the Miele Customer Service Department. This information can be found on the data plate.

Please note that telephone calls may be monitored and recorded for training purposes and that a call-out charge will be applied to service visits where the problem could have been resolved as described in this booklet.

The data plate is found above the porthole glass when the door is opened.

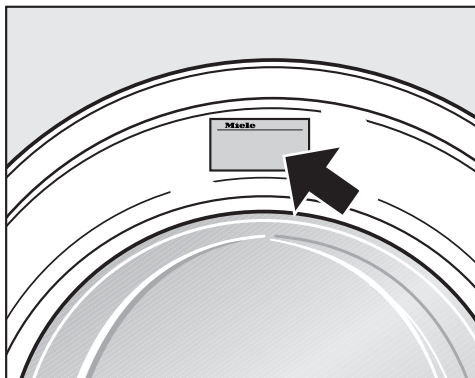

Optional accessories

Optional spare parts and accessories for this washing machine are available from your Miele Dealer, the Miele Spare Parts Department or via the internet at www.miele.co.uk.

Please note that telephone calls may be monitored and recorded for training purposes.

Guarantee

For information on the appliance guarantee specific to your country please contact Miele. See end of this booklet for contact details.

Installation

Front view

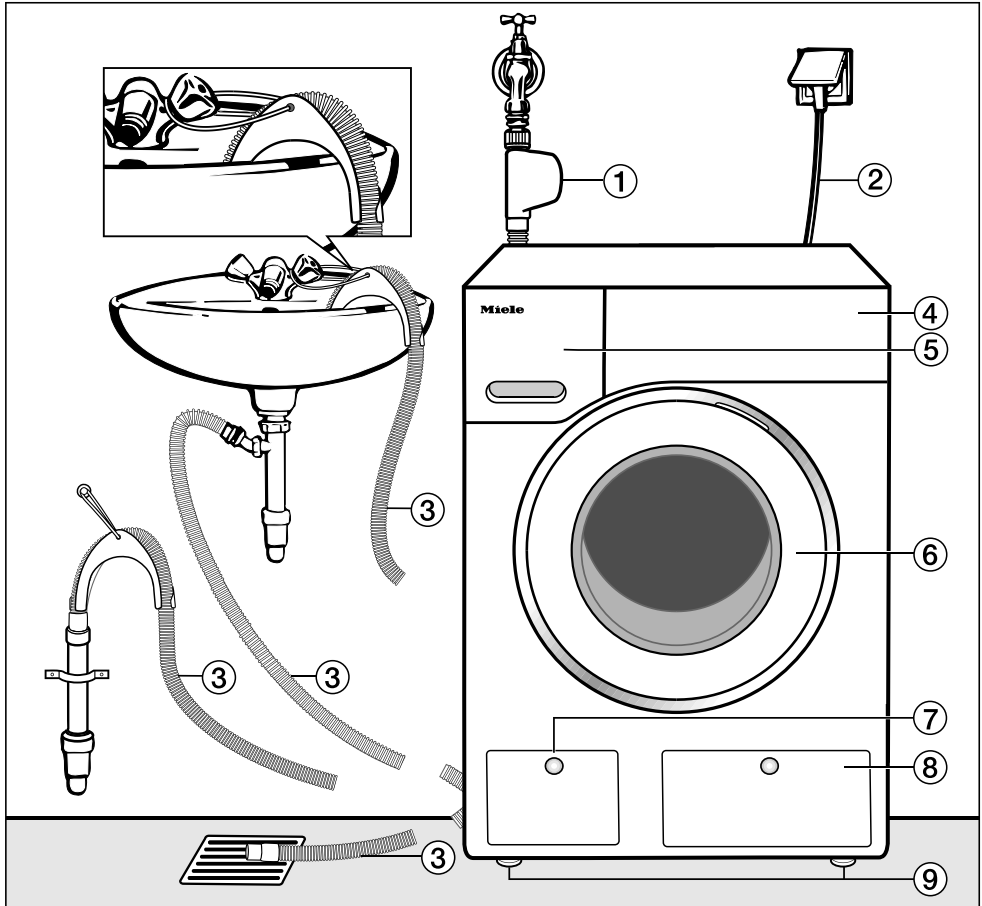

- ① Inlet hose with Waterproof system
- ② Mains connection cable
- ③ Flexible drain hose (with detachable swivel elbow)
- ④ Control panel
- ⑤ Detergent dispenser drawer

- ⑥ Door
- ⑦ Access to filters, pumps and emergency release
- ⑧ Access panel for TwinDos cartridges
- ⑨ Four height-adjustable feet

Rear view

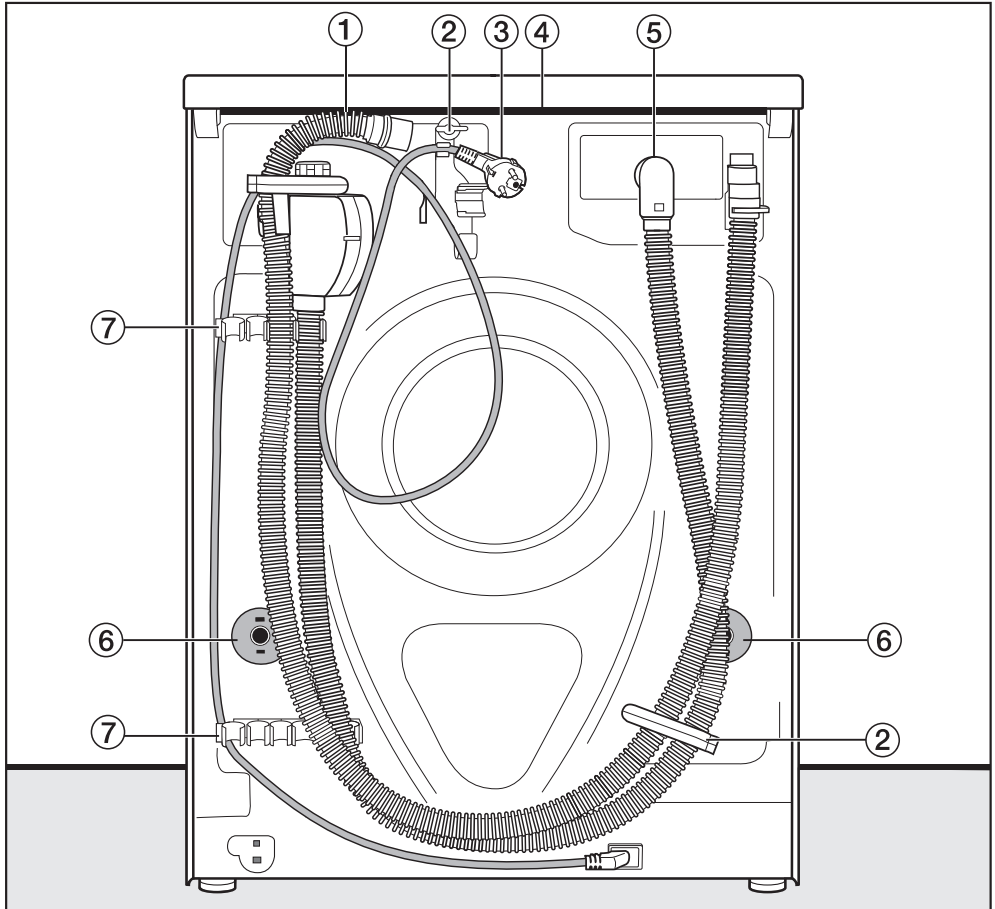

- ① Drain hose
- ② Transport clips for inlet and drain hoses and mains connection cable
- ③ Mains connection cable
- ④ Protruding lid for holding when moving the machine
- ⑤ Inlet hose with Waterproof system
- ⑥ Safety caps for transit bars
- ⑦ Transport clips for inlet and drain hoses and for storing transit bars when not in use

Installation

Installation surface

A concrete floor is the most suitable installation surface. It is far less prone to vibration during the spin cycle than wooden floorboards or a carpeted surface.

Please note:

- The machine must be level and securely positioned.
- To avoid vibrations during spinning, the machine should not be installed on soft floor coverings.

If installing on a wooden joist floor:

- Install the machine on a plywood base (at least 59 x 52 x 3 cm). The base should span several joists and be bolted to the joists and not only to the floorboards. Check for the presence of pipes and cables first.

Tip: If possible, install the machine in a corner. This is usually the most stable part of the floor.

 Injury can occur if the washing machine has not been adequately secured.

During installation, the washing machine must be secured on a plinth to be made available on site (concrete or brick), in order to ensure it cannot fall or slip.

Secure the washing machine using a clamp/fastening bracket (MTS floor mounting kit – available from your Miele dealer or Miele spare parts department).

Transporting the washing machine to its installation site

 Danger of injury due to unsecure lid.

Make sure the fixings at the back of the lid are secure. Otherwise there is a danger of the lid being pulled off when carrying the machine.

Before carrying the machine check that the lid is secure where it protrudes at the back of the machine.

- Carry the washing machine by the front feet and by the lid where it protrudes at the back of the appliance.

Removing the transit bars

Removing the left-hand transit bar

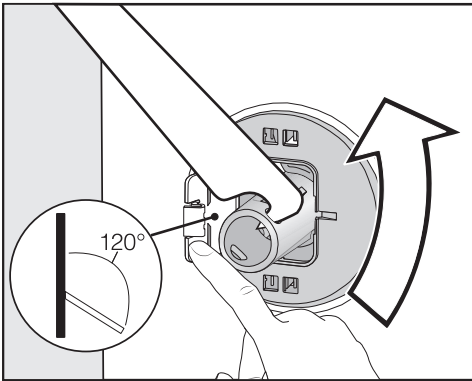

- Push the cover out and turn the left-hand transit bar 90° using the spanner supplied.

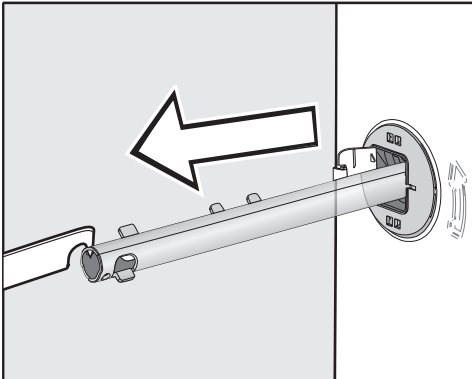

- Withdraw the transit bar.

Removing the right-hand transit bar

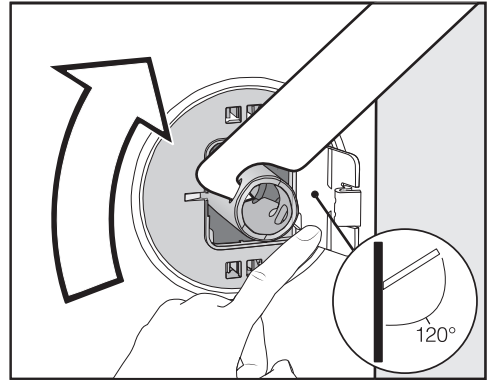

- Push the cover out and turn the left-hand transit bar 90° using the spanner supplied.

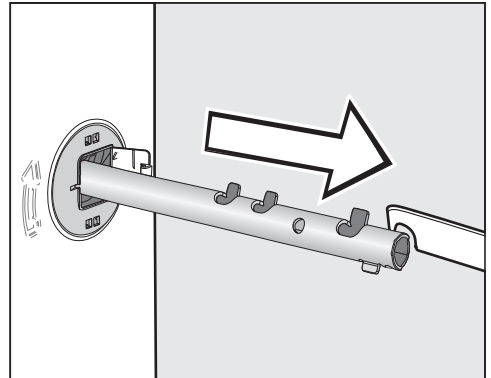

- Withdraw the transit bar.

Installation

Covering holes

 Risk of injury from sharp edges. There is a risk of injury from reaching into holes that are not covered. Cover the holes for the transit bars after they have been removed.

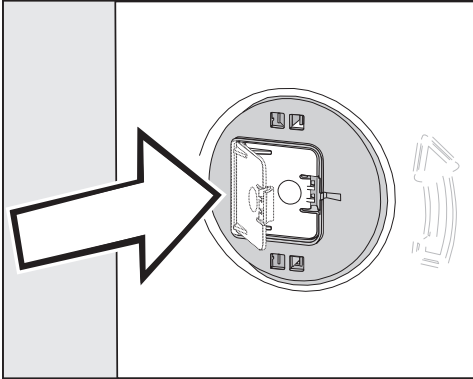

- Push the covers in firmly until they engage in position.

Securing the transit bars

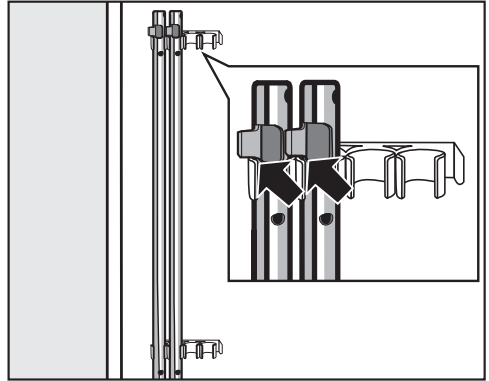

- Secure the transit bars to the back of the washing machine. Make sure that the top catch is located above the holder.

 Risk of damage from incorrect transport.

The washing machine may become damaged if moved without the transit bars in place.

Keep the transit bars in a safe place. Fit them again if the machine is to be moved (e.g. when moving house).

Fitting the transit bars

Opening the covers



- Press against the retainer with a sharp object (a narrow screwdriver, for example).

The cover opens.

Fitting the transit bars

- To fit the bars, follow the instructions for removing them in reverse order.

Tip: The bars will slide in more easily if you lift the drum slightly.

Installation

Levelling the machine

The washing machine must stand perfectly level on all four feet to ensure safe and proper operation.

Incorrect installation may increase electricity and water consumption and may cause the machine to move about.

Screwing out and adjusting the feet

The four adjustable screw feet are used for levelling the washing machine. The machine is supplied with all four feet are screwed in.

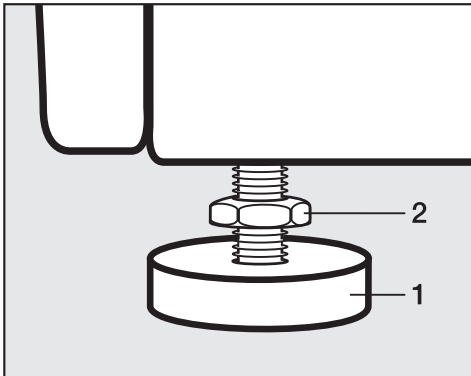

- Using the spanner supplied, turn counter nut **2** in a clockwise direction. Then turn counter nut **2** together with foot **1** to unscrew.

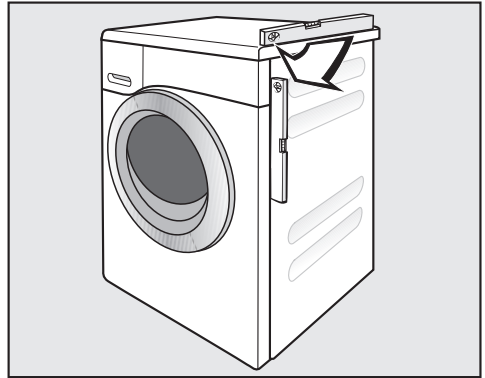

- Use a level to check that the washing machine is standing level.
- Hold foot **1** securely with a pipe wrench. Turn counter nut **2** again using the spanner supplied until it sits firmly up against the housing.

 Risk of damage due to incorrectly aligned washing machine. There is a danger of the washing machine moving about if the feet are not secured. Turn all four counter nuts for the feet until they sit firmly up against the housing. Please also check this for the feet which did not need adjustment.

Installing under a continuous worktop

 Risk of electric shock due to exposed cables

There is a risk of coming into contact with live parts while the lid is removed.

Building under kits* must only be installed/dismantled by a suitably qualified fitter in accordance with the instructions supplied.

- A special **building under kit*** is required. The cover plate supplied with the building under kit is used to replace the machine lid. It is necessary to fit the coverplate for electrical safety reasons.
- Connections for electricity, water and drainage should be installed in such a way that they remain accessible when the machine is in its final position.

Fitting instructions are supplied with the building-under kit.

Washer-dryer stack

The washing machine can be combined with a Miele tumble dryer in a washer-dryer stack. The appropriate “WTV” stacking kit* to match your dryer is required.

All parts marked* are available from your Dealer or Miele.

Please note:

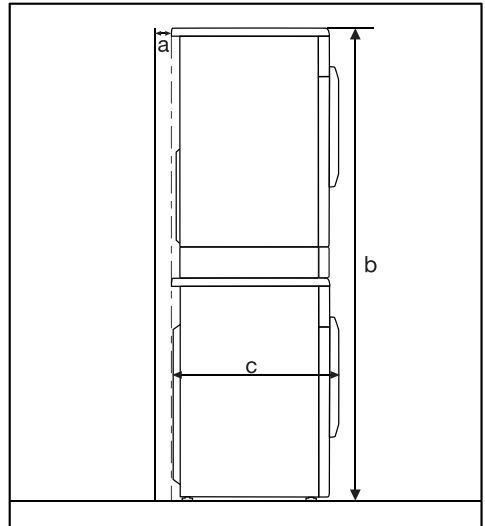

a = at least 2 cm

b = WTV without drawer: 172 cm
WTV with drawer: 181 cm

c = 64 cm

Installation

The water protection system

The Miele water protection system protects all parts of the washing machine from water damage.

The system consists of three main components:

- the inlet hose
- the electronic unit and drainage and overflow protection
- the drain hose

The Waterproof System (WPS)

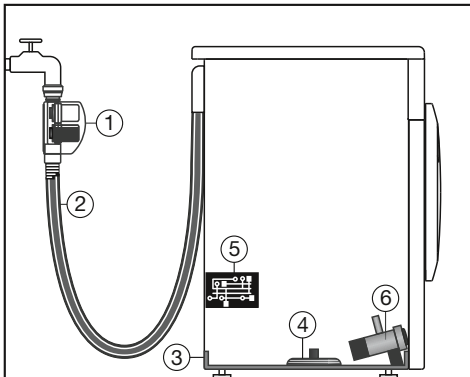

- ① Two solenoid valves
- ② Double-skinned inlet hose
- ③ Sump
- ④ Float switch
- ⑤ Electronic unit
- ⑥ Drain pump

Inlet hose

- The casing on the inlet hose contains two solenoid valves ①, which cut off the water intake directly at the stopcock. These valves provide two-fold protection. In the event that one of the valves is faulty, the other valve will cut off the water intake.

Blocking the water intake at the stopcock means that the inlet hose is only under pressure whilst water is being taken into the machine. For the remainder of the time, pressure on the inlet hose is negligible.

- Protection against the solenoid valves bursting
The solenoid valves are pressure tested to between 7,000 kPa and 10,000 kPa against bursting.
- The double-skinned inlet hose ② has a pressure-resistant inner hose and a protective sleeve. Any leaking water is fed into the sump ③ through this protective sleeve. A float switch ④ closes the solenoid valves, preventing any more water flowing into the machine and water in the suds container is pumped away.

The electronic unit ⑤ and drainage and overflow protection

- Drainage protection
Any leaking water is collected in the sump ③ in the base of the machine. A float switch ④ closes the solenoid valves ①, preventing any more water from flowing into the machine and water in the suds container is pumped away.
- Overflow protection
If the water level exceeds a certain level, the drain pump ⑥ switches in and pumps the excess water away in a controlled manner. Should the water level rise repeatedly in an uncontrolled way, the drain pump ⑥ will switch on continuously, the washing machine will indicate that there is a fault and a tone will sound.

Drain hose

The drain hose is protected by a ventilation system which prevents the washing machine from being emptied completely.

Installation

Connection to the water supply

 Health risk and risk of damage due to contaminated incoming water.

The quality of the incoming water must correspond to the drinking water specification of the country in which the washing machine is being operated.

Always connect the washing machine to the mains water supply.

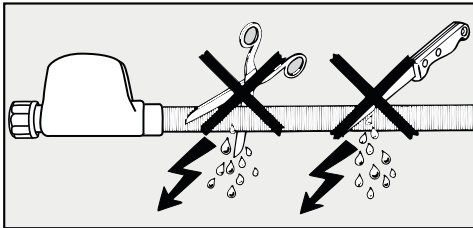

 Risk of electric shock!

There are electrical wires in the water inlet hose.

The inlet hose must not be connected in an area subject to spray water, e.g. in a bathroom or shower room.

The washing machine should be connected to the mains water supply in accordance with current local and national safety regulations. The German authorities do not require it to have a non-return valve as the washing machine has been designed to comply with DIN regulations.

The water-connection pressure needs to be between 100 kPa and 1000 kPa. If the water-connection pressure exceeds 1000 kPa, a pressure reducing valve must be installed.

A stopcock with a $\frac{3}{4}$ inch threaded union is required for the connection. If this is not available, only a qualified installer may connect the washing machine to the mains water supply.

The screw thread is subject to water connection pressure.

Check the connection for leaks. Slowly open the stopcock. Correct the position of the seal and screw thread if necessary.

The washing machine is not suitable for connection to a hot water supply.

The washing machine must not be connected to a hot water supply.

Maintenance

Only use a **Miele Waterproof system** hose should you need a replacement.



Damage caused by dirty water.

This washing machine has a filter in the hose connection to the casing to protect the solenoid valve.

This filter must not be removed.

Hose extension

A 1.5 metre long (metal) extension hose is available from your Miele dealer or the Miele Spare Parts Department as an optional extra.

This hose is tested to withstand pressures of up to 14,000 kPa and can be used as a flexible extension to the water supply.

Installation

Water drainage

The suds are drained through a drain pump with a 1 m high delivery head. For the water to drain freely, the hose must be free of kinks.

If required, the hose can be extended to a length of up to 5 m. Accessories are available from your Miele dealer or from the Miele Customer Service Department.

For drain heights of more than 1 m (up to a maximum delivery head of 1.8 m), a replacement drain pump will need to be fitted. Please contact Miele for advice. For a drain height of 1.8 m, the hose can be extended to a length of up to 2.5 m. Accessories are available from your Miele dealer or from the Miele Customer Service Department.

Drainage options:

1. Directed into a sink or basin:

Please note:

- Hook the hose over the edge and secure it.
- If the water is pumped into a washbasin, make sure that it can drain away freely. Otherwise there is a risk of water overflowing or of some of the drained water being sucked back into the machine.

2. Connected securely to a plastic drain pipe with a rubber nipple (there is no need to use a siphon).

3. Connected securely to a floor drain (gully).

4. Connected securely to a washbasin with plastic nipple.

Fitting the elbow

Use the elbow supplied to stop the drain hose from slipping.

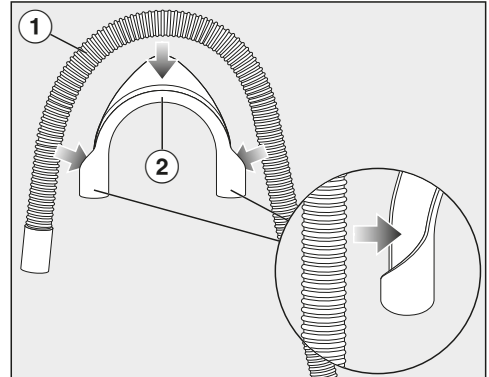

- Attach the elbow ② to the drain hose ①.

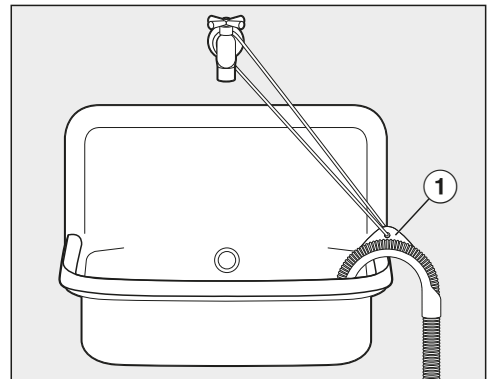

- Place the end of the drain hose in a sink.
- Use a strap and the eye ① to stop the elbow from slipping.

Direct connection to a sink drain outlet



- ① Adapter
- ② Spigot nut
- ③ Hose clip
- ④ End of the hose

- Fit adapter ① to the sink drain outlet using nut ②.
- Attach the end of hose ④ to adapter ①.
- Use a screwdriver to tighten hose clip ③ up close to the nut.

Installation

Electrical connection

The washing machine is supplied with an electrical connection cable with a moulded plug ready for connection to a switched socket.

The socket must be easily accessible after the washing machine has been installed. If that is not possible, ensure that a suitable means of disconnection is provided on the installation side for each pole.



Risk of fire from overheating.

Connecting the washing machine to a multi-socket plug adapter or to an extension lead can overload the cable.

Do not use an extension lead or multi-socket plug adapter.

The electrical system must comply with local and national safety regulations (BS 7671 in the UK). We recommend the use of a suitable RCD .



If the connection cable is damaged, it must only be replaced with a specific connection cable of the same type (available from the Miele Customer Service Department). For safety reasons, such replacement may only be carried out by a qualified technician or the Miele Customer Service Department.

The data plate indicates the nominal power consumption and the appropriate fuse rating. Compare the specifications on the data plate with those of the electricity supply and make sure that they match.

If in any doubt, consult a qualified electrician.

Temporary or permanent operation on an autonomous power supply system or a power supply system that is not synchronised with the mains power supply (e.g. island networks, back-up systems) is possible. A prerequisite for operation is that the power supply system complies with the specifications of EN 50160 or an equivalent standard. The function and operation of the protective measures provided in the domestic electrical installation and in this Miele product must also be maintained in isolated operation or in operation that is not synchronised with the mains power supply, or these measures must be replaced by equivalent measures in the installation. As described, for example, in the current version of BS OHSAS 18001-2 ISO 45001.

Consumption data

		Load	Energy	Water	Duration	Residual moisture
		kg	kWh	Litres	h:min	%
ECO 40-60		9.0	0.90	65	3:19	42
Cottons	60 °C	9.0	1.45	65	2:31	50
	 * 60 °C	9.0	0.95	50	2:59	44
	20 °C	9.0	0.40	79	2:41	46
Minimum iron	30 °C	4.0	0.34	56	2:01	30
Express 20 ¹⁾	40 °C	3.5	0.33	30	0:20	–
Woolens 	30 °C	2.0	0.23	38	0:40	–
QuickPowerWash	40 °C	4.0	0.58	40	0:49	–

1) Quick Extra activated

Consumption data can vary from the nominal values given depending on water pressure, water hardness, water inlet temperature, room temperature, type and volume of load, fluctuations in the electricity supply and any extras selected.

The consumption data shown in the Feedback display can vary from the consumption data quoted here. The variations arise from component tolerances and on-site conditions e.g. fluctuations in the pressure of the water supply, mains voltage and fluctuations in the mains voltage.

Note for test institutes

*Test programme in accordance with IEC 60456 or EN 60456.

With the *PowerWash* washing technique, during the heating phase, the temperature measured by the sensor in the suds container is higher than the actual temperature of the laundry.

The temperature measured at the sensor **does not** reflect the temperature of the laundry.

TwinDos dispensing must be deactivated when carrying out comparison tests.

Technical data

Height	850 mm
Width	596 mm
Depth	636 mm
Depth with door open	1054 mm
Height for building under	820 (+8/-2) mm
Width for building under	600 mm
Depth for building under	600 mm
Weight	Approx. 95 kg
Capacity	9.0 kg dry laundry
Supply voltage	See data plate
Rated load	See data plate
Fuse rating	See data plate
Consumption data	See “Consumption data”
Minimum water flow pressure	100 kPa (1 bar)
Maximum water flow pressure	1000 kPa (10 bar)
Water inlet hose length	1.60 m
Drain hose length	1.50 m
Length of mains connection cable	2.00 m
Maximum delivery head	1.00 m
Maximum drainage length	5.00 m
LEDs	Class 1
Test certifications awarded	See data plate
Power rating in off mode	0,30 W
Networked standby	0,70 W
Frequency range	2.4000–2.4835 GHz
Maximum transmission power	< 100 mW

You can use the settings to alter the washing machine's electronics to suit changing requirements.

The settings can be altered at any time.

Accessing the settings menu

- Switch on the washing machine.
- Scroll to the second page in the main menu.
- Touch the **Settings** sensor.

The display will change to show the Settings menu.

Selecting settings

The settings are grouped into different areas.

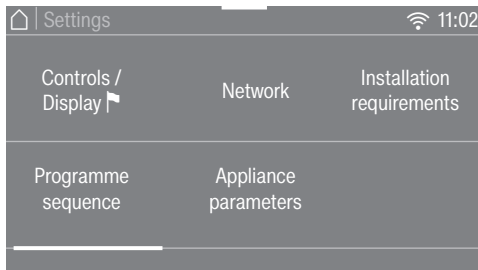

- Select the required area.
- Scroll through the list until the setting you want appears.
- Touch the sensor to select the setting you require.

Changing a setting

- Change the value displayed and confirm with **OK**.

or

- Touch an option to select it.

An option which is selected will be highlighted orange.

The option is saved. The display will then switch to the Settings menu, or go back to the previous menu level.

Closing the settings menu

- Touch the **↶** sensor.

The display will then go back to the previous menu level.

- Touch the **⏠** sensor.

The display will change to show the main menu.

Settings

Controls / Display ▾

Language ▾

The display can be set to appear in one of several different languages.

The flag ▾ after the word *Language* (Sprache in German) acts as a guide in case a language which is not understood has been set.

The language selected is saved.

Consumption

In this setting you can check the saved energy and water consumption values and enter the energy cost.

Options

- Previous programme
Shows the consumption for the last wash programme carried out.
- Total consumption
Shows the sum of the energy and the sum of the water used by the previous programmes.
- Set the cost
You can enter the cost for energy (electricity) and water.

Code

The code prevents the washing machine being used without your knowledge.

Options

- Activate
If you activate the code, you have to enter a code after switching the washing machine on. Otherwise it cannot be operated.
The factory default code is 125.
- Change
If wished, you can set a different three-digit code.

 Do not forget the code you have set.

If you forget the code, only Miele Technical Service can unlock the washing machine.

Make a note of your new code.

- Deactivate
The washing machine is to be operated again without entering a code. This only appears if the code had been activated previously.

Memory

The washing machine will save the last settings (temperature, spin speed and some of the Extras) selected for a programme after the programme has started.

When the programme is chosen again, the saved settings will appear in the display.

Memory is deactivated as standard.

Clock display

After selecting the Clock format you can set the time of day.

Clock format

- 24 h clock (default setting)
- 12 h clock

Set

- The time of day can be set.

Volume

Finish tone

The volume can be changed for the buzzer that sounds at the end of the programme.

It can be set to one of 7 different settings or switched off altogether.

Keypad tone

The volume of the tone that sounds when a sensor is touched can also be changed.

It can be set to one of 7 different settings or switched off altogether.

Display brightness

The brightness of the display can be altered.

It can be set to one of 7 different settings.

Units

The temperature can be displayed as degrees Celsius (°C) or Fahrenheit (°F).

The factory setting is °C/Celsius.

“Display” off status

The display and the sensor control lighting is switched off to save energy. The *Start/Stop* sensor flashes slowly.

Options

- Off
The lighting remains switched on.
- On (factory setting)
The lighting switches off after 10 minutes.
- On. Not in current prog.
The lighting remains switched on throughout the programme. The lighting switches off 10 minutes after the programme has ended.

Settings

Programme sequence

TwinDos

You can set the type of detergent and dispensing quantities and check the level of the UltraPhase 1 and UltraPhase 2 cartridges.

Select detergent

If you wish to use your own detergent with the TwinDos function instead of UltraPhase 1 and 2, you will need to purchase the empty TwinDos containers separately (optional accessories).

UltraPhase 1 and 2 can only be dispensed as a package. If a different agent is selected, the setting for the other compartment is automatically deleted.

The following agents can be used:

- Miele UltraPhase 1
- Miele UltraPhase 2
- Universal detergent
- Colour detergent
- Delicates detergent
- Delicates/Woollens
- Fabric conditioner

Follow the manufacturer's instructions on dosage given on the packaging.

The dosage amount required for the agent being used must be set. Follow the instructions in the display on how to do so.

Tip: If you select No agent the respective TwinDos compartment will be deactivated.

Change dosage

The values set for dispensing detergent from compartments ① and ② can be checked and corrected.

Soiling

You can specify the default setting for the degree of soiling.

The following soiling levels are available to choose from:

- Light
- Normal
- Heavy

The Factory default setting is: Normal

Water plus level

There are four different water levels which can be selected for the Water plus Extra.

Levels

- Normal (default setting)
- Plus ∆
- Plus ∆∆
- Plus ∆∆∆

Maximum rinse level

The water level in the rinses can be permanently set to the highest value.

This function is important for allergy sufferers as it achieves excellent rinse results. The water consumption will be increased.

The maximum rinse level is deactivated as standard.

Soak duration

You can set a duration for the soak process of between 30 minutes and 6 hours.

The duration can be selected in 30 minute increments. When the *Soak* extra option is selected, the laundry will be soaked for the duration selected.

A duration of 0: 30 h is set as standard.

Longer Pre-wash Cottons

If you require a longer pre-wash, you can extend the standard pre-wash time of 25 minutes in the *Cottons* programme.

- Normal (factory setting)
25 minute pre-wash.
- + 6 min
31 minute pre-wash.
- + 9 min
34 minute pre-wash.
- + 12 min
37 minute pre-wash.

Gentle action

With gentle action activated, drum agitation is reduced. In this way, lightly soiled items can be washed more gently.

Gentle action can be activated for the *Cottons* and the *Minimum iron* programmes.

Gentle action is deactivated as standard.

Anti-crease

The Anti-crease function reduces creasing after the end of the programme.

At the end of the programme, the drum continues to turn at intervals for up to 30 min. The washing machine door can be unlocked at any time by touching the *Start/Stop* sensor and then opened.

Anti-crease is activated as standard.

Settings

Network

Miele@home

Control the networking of your washing machine with your WiFi network.

The following points may appear in the submenu:

Set up

This message only appears if the washing machine has not yet been connected to a WiFi network.

Please refer to “Before using for the first time” for instructions on how to set up the connection.

Activate

(visible if Miele@home is deactivated)

The WiFi function is reactivated.

Deactivate

(visible if Miele@home is activated)

Miele@home remains set up, the WiFi function is switched off.

Connection status

(visible if Miele@home is activated)

The following values are displayed:

- The quality of WiFi reception
- The network name
- The IP address

Set up again

(visible if set up)

Resets the WiFi login (network) to immediately re-establish a new connection.

Reset

(visible if set up)

- The WiFi is switched off.
- The WiFi connection will be reset to the factory default setting.

The network configuration should be reset whenever a washing machine is being disposed of or sold, or if a used washing machine is being put into operation. This is the only way to ensure that all personal data has been removed and the previous owner will no longer be able to access the washing machine.

A new connection setup has to be carried out in order to use the Miele@home setting again.

SmartGrid

The **SmartGrid** setting is only visible if the **Miele@home** setting is set up and activated.

You can set your washing machine to start automatically based on an external signal within a certain time period.

Activating **SmartGrid** gives the *Timer* sensor a new function. Use the “**Timer**” sensor to set *SmartStart*. The washing machine will then start within the time period specified by you when it receives an external signal. If an external signal has not been received by the latest start time set, the washing machine will start automatically (see the “**Delay start**” chapter).

SmartGrid is deactivated as standard.

Remote control

The **Remote control** setting is only visible if the **Miele@home** setting is set up and activated.

Once the Miele app has been installed on your mobile device, you can check the status of your washing machine from anywhere and start it remotely. You can also control it remotely via the *MobileControl* programme.

You can switch off the **Remote control** setting if you do not want to operate the washing machine with your mobile device.

If **Remote control** is not switched on, the app can cause the programme to be cancelled.

Use the “**Timer**” sensor control to set a timeframe within which you want to start the washing machine and the timer (see “**Timer**”).

The washing machine will then start within the timeframe specified when it receives your signal.

If it has not received a start signal by the latest start time set, the washing machine will start automatically.

Remote control is activated by default.

Settings

RemoteUpdate

The RemoteUpdate menu option is only displayed and can only be selected if the requirements for using Miele@home have been met (see “Before using for the first time – Miele@home”).

The RemoteUpdate function is used to update the software in your washing machine. If an update is available for your washing machine, it will automatically download it. Updates will not be installed automatically. They must be initiated manually.

If you do not install an update, you can continue to use your washing machine in the usual way. However, Miele recommends installing updates.

Activating/Deactivating

The RemoteUpdate function is activated as standard. Available updates will be downloaded automatically but will only be installed if you initiate installation manually.

Deactivate RemoteUpdate if you do not want any updates to be downloaded automatically.

Running RemoteUpdate

Information about the content and scope of an update will be provided in the Miele app.

A message will appear in your washing machine display if a software update is available.

You can install the update immediately or postpone this until later. When the washing machine is switched on again, you will be reminded about the update.

Deactivate RemoteUpdate if you do not want to install the update.

The update may take several minutes.

Please note the following information about the RemoteUpdate function:

- You will only receive a message when an update is available.
- Once an update has been installed, it cannot be undone.
- Do not switch off the washing machine during an update. Otherwise, the update will be aborted and will not be installed.
- Some software updates can only be carried out by the Miele Customer Service Department.

Appliance parameters

Legal information

[Open source licences](#)

You can view information here.

Copyrights and licences for operator and control software

Miele uses their own and third party software which is not subject to any so-called Open Source Licence for the operation and control of the appliance. This software/these software components are protected by copyright. The copyright powers of Miele and third parties have to be respected.

Furthermore, this appliance contains software components which are distributed under Open Source licence conditions. Please refer to the menu item [Settings | Appliance parameters | Legal information | Open source licences](#) in the appliance for the Open Source components contained therein, together with the corresponding copyright notices, copies of the licencing conditions valid at the time, and any further information. The liability and warranty provisions of the Open Source licence terms and conditions as stated therein apply only in relation to the respective rights holders.

Copyrights and licences for the communication module

For the purpose of operating and controlling the communication module, Miele uses proprietary or third-party software that is not covered by open source licensing terms. These items of software/software components are protected by copyright. The copyrights held by Miele and third parties must be respected.

Furthermore, this communication module contains software components which are distributed under open source licence conditions. The open source components contained in the appliance along with the corresponding copyright notices, copies of the licensing terms valid at the time, and any further information can be accessed locally via IP using a web browser (<http://<IP address>/Licenses>). The liability and warranty arrangements for the open source licences displayed in this location only apply in relation to the respective rights holders.

Settings

Installation requirements

Low water pressure

If the water pressure is below 100 kPa (1 bar), the programme will be cancelled and a fault message will appear.

If the on-site water pressure cannot be increased, activating this function will prevent the programme from being cancelled.

Low water pressure is deactivated as standard.

Suds cooling

Additional water flows into the drum at the end of the main wash to cool the suds down.

Suds cooling takes place when a Cottons programme with a temperature of 70 °C or higher is selected.

Suds cooling should be activated:

- to prevent the danger of scalding if the drain hose is hooked over the edge of a sink or basin.
- where the drainage pipes do not comply with DIN 1986.

Suds cooling is deactivated as standard.

Temperature reduction

At high altitudes water has a lower boiling point. Miele recommends activating the reduced temperature setting at altitudes of 2000 m or above to prevent water from boiling. The maximum temperature is reduced to 80 °C even if a higher temperature is selected.

Temp. reduction is deactivated as standard.

Detergent, fabric care products, additives and machine care products are available for this washing machine. All products have been designed for Miele washing machines.

These and many other products can be ordered from www.shop.miele.com, the Miele Customer Service Department or your Miele dealer.

Detergent

Miele UltraPhase 1 and 2

- 2-component detergent for whites and colours
- For brilliant colours and spotlessly white laundry
- Excellent stain removal even at low temperatures

UltraWhite (powder detergent)

- Best results at 20/30/40/60/95 °C
- Radiant white laundry thanks to powerful formula with active oxygen
- Excellent stain removal even at low temperatures

UltraColor (liquid detergent)

- Best wash results at 20/30/40/60 °C
- With colour-protection formula for brilliant colours
- Excellent stain removal even at low temperatures

WoolCare delicates detergent (liquid detergent)

- For wool, silks and delicates
- Special care complex based on wheat protein and with colour-protection formula
- Best wash results at 20/30/40/60 °C

Detergents and care products

Specialist detergents

These specialist detergents are available as convenient single-use capsules.

Caps Sport

- For synthetic fabrics
- Neutralises odours thanks to built-in odour absorber
- Prevents static charge in clothes
- Retains the shape and breathability of synthetic fabrics

Caps DownCare

- For down-filled items
- Retains the elasticity and breathability of down
- Lanolin for effective cleaning and gentle care
- Down does not stick together and retains its loft

Caps WoolCare

- Woollens and delicates detergent
- Special wheat-protein-based agents
- Fibre-protection technology to help prevent items shrinking and felting
- Colour-protection formula for gentle cleaning

Caps CottonRepair

- Special-purpose detergent for cotton fabrics
- Visibly renews fabric with just one wash
- Special Miele formula with Novozymes technology
- Removes pilling and renews colour intensity and brightness
- Depending on fabric do not use more than 1–2 times per year

Fabric care

These fabric care products are available as convenient single-use capsules.

Fabric conditioner cap

- Fabric conditioner for freshly scented laundry
- Pure and thorough cleanliness with a fresh scent
- For soft, bouncy laundry
- Prevents static charge in clothes

Additives

Additives are available as convenient single-use capsules.

Cap Booster

- Highly effective stain remover
- Enzyme technology to help remove stubborn stains
- Suitable for whites and colours
- For best wash results even at low temperatures

Machine care

TwinDosCare

- Cleaning agent for the TwinDos dispensing system
- Use before a prolonged downtime (at least 2 months)
- Use before changing to a different product

Descaling agent

- Removes heavy limescale deposits
- Mild and gentle with natural citric acid
- Gentle on heater elements, drum and other components

IntenseClean

- For hygienic cleanliness in washing machines
- Removes grease, bacteria and associated unpleasant odours
- Effective thorough cleaning

Water softener tablets

- Reduces the amount of detergent needed for hard water
- Less detergent residue in fabrics
- Less chemicals in waste water due to reduced amount of detergent

Singapore

Miele Pte. Ltd.
29 Media Circle
#11-04 ALICE@Mediapolis
Singapore 138565
sTel: +65-67351191
Fax: +65-67351161
E-Mail: info@miele.com.sg
Internet: www.miele.sg

Malaysia

Miele Sdn Bhd
Suite 12-2, Level 12
Menara Sapura Kencana Petroleum
Solaris Dutamas No. 1
Jalan Dutamas 1
50480 Kuala Lumpur, Malaysia
Phone: +603-6209-0288
Fax: +603-6205-3768

Germany

Miele & Cie. KG
Carl-Miele-Straße 29
33332 Gütersloh

Hong Kong, China

Miele (Hong Kong) Limited
41/F - 4101, Manhattan Place
23 Wang Tai Road, Kowloon Bay
Hong Kong
Tel: (852) 2610 1025
Fax: (852) 3579 1404
Email: customerservices@miele.com.hk
Website: www.miele.hk

Thailand

Miele Appliances Ltd.
BHIRAJ TOWER at EmQuartier
43rd Floor Unit 4301-4303
689 Sukhumvit Road
North Klongton Sub-District
Vadhana District
Bangkok 10110, Thailand

WCR 860 WPS

en-SG

M.-Nr. 11 623 591 / 00