

## Operation

### Controls and indicators

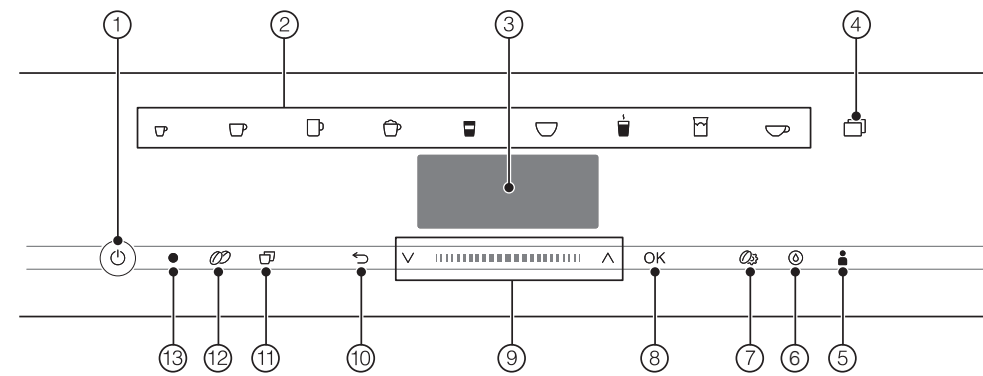

- ① On/Off button
- ② Drink buttons
- ③ Display
- ④ sensor button
- ⑤ Profiles sensor button
- ⑥ Maintenance sensor button
- ⑦ Parameters sensor button
- ⑧ OK sensor button
- ⑨ Navigation area with arrow buttons ^ v
- ⑩ "Back" sensor button
- ⑪ "2 portions" sensor button
- ⑫ "DoubleShot" sensor button
- ⑬ Optical interface (for Miele Customer Service only)

### Explanation of drink symbols

- ☐ Espresso
- ☐ Coffee
- ☐ Long coffee
- ☐ Cappuccino
- ☐ Latte macchiato
- ☐ Caffè latte
- ☐ Hot milk
- ☐ Milk froth
- ☐ Tea water

Your coffee machine may be different from the illustrations in the Quick Start Guide, depending on the model.

### Operation

To operate the coffee machine, tap the sensor buttons with your finger.

### Drinks menu

When the following appears in the display, you are in the drinks menu: Select drink.

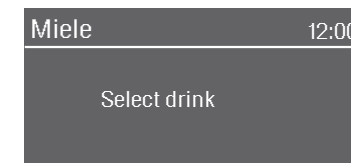

You can find more drinks in the Additional menu (sensor button).

### Navigation area

To select a menu option, keep pressing the arrow buttons ^ and v until the option you want is highlighted.

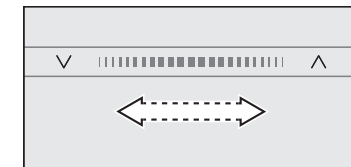

To scroll more quickly through the options, swipe your finger right or left in the area between the arrows.

As soon as you reach a confirmable value, message, or setting, the OK sensor button will light up.

Tap OK to confirm your selection.

### Selecting a menu and navigating within a menu

To select a menu, tap the relevant sensor button, e.g., the sensor button.



You will then be able to start an action or change settings in the menu. A scroll bar at the right of the display shows that additional options or text are available.

The setting which is currently selected in a list will have a checkmark ✓ beside it.

### Exiting a menu or canceling an action

To exit the current menu, tap the sensor button. Alternatively, tap the lit orange sensor button again to return to the drinks menu.

### Entering a name

Letters and numbers are entered via the navigation area. You can choose between upper and lower case letters.

**Tip:** It is best to select short, memorable names.



- To enter a character, highlight the one you want on the bottom line. Confirm your selection with OK.

- To delete a character, tap the sensor button.

- To save the name, select the checkmark ✓ and confirm with OK.

## Description

### Front view

- ① On/Off button
- ② Control panel
- ③ Door handle
- ④ Height-adjustable main dispenser with lighting
- ⑤ Drip-tray cover
- ⑥ Milk container

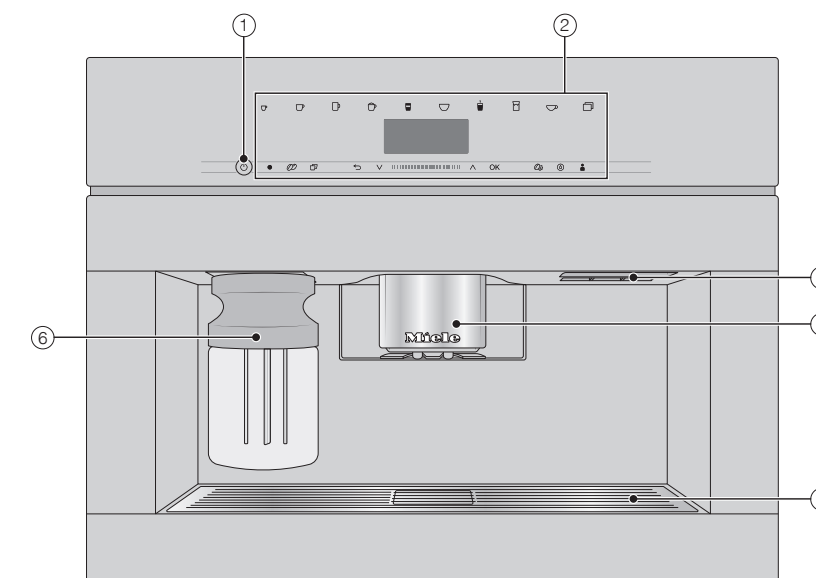

### Interior view

- ① Bean container
- ② Milk valve
- ③ Height-adjustable main dispenser with lighting
- ④ Grinder setting
- ⑤ Bean container
- ⑥ Fan outlet
- ⑦ Water container
- ⑧ Drip tray with lid
- ⑨ Brew unit
- ⑩ Grounds container
- ⑪ Maintenance container
- ⑫ Drip tray

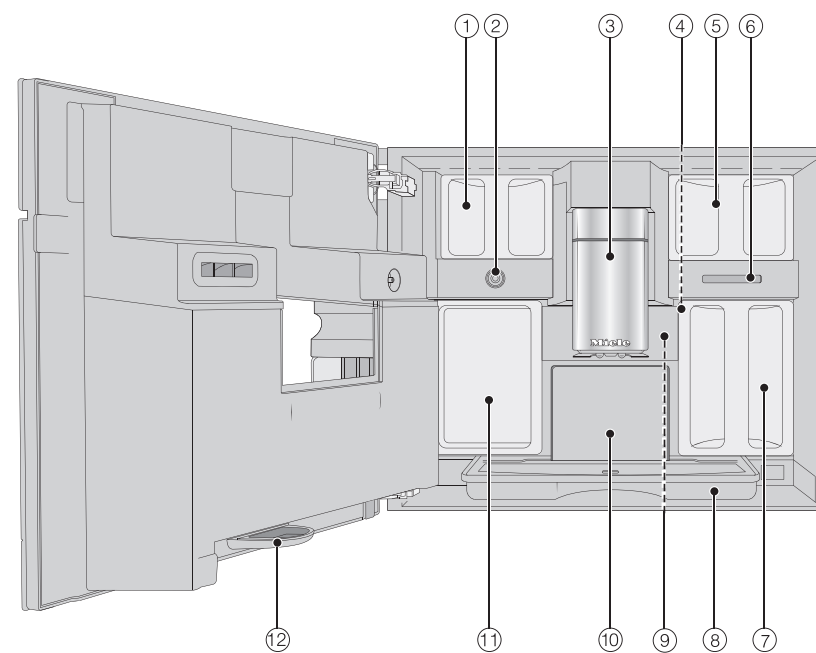

## Preparing for use

### Filling the water container

- Open the appliance door.
- Pull the water container forward to remove it.
- Fill the water container with fresh, cold drinking water up to the max. mark.
- Push the water container back into the coffee machine and close the appliance door.

### Filling the bean containers

Only put roasted coffee beans in the bean containers.

- Open the appliance door.

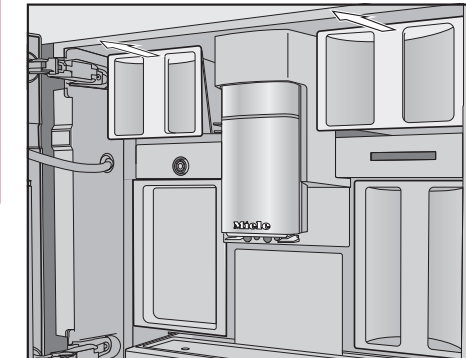

- Pull the bean containers out and take off the lids.
- Fill the bean containers with coffee beans and put the lids back on the bean containers to seal them.
- Push the bean containers all the way back into the coffee machine.
- Close the appliance door.

GUIDE TO THE APPLIANCE/PREPARING FOR USE

## Making drinks

### Making a drink

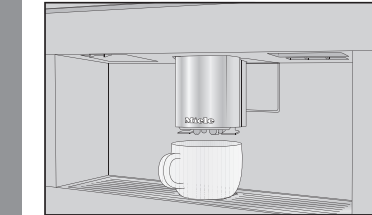

- Place a cup under the main dispenser.
- Tap the sensor button for the drink you want.

### Canceling a drink

When preparing drinks with several ingredients (e.g., latte macchiato), you can cancel each of the individual components prematurely.

- Tap the lit orange symbol on the control panel again.
- Tap OK when Stop appears on the display.

### DoubleShot

Select the DoubleShot function if you would like a particularly strong and aromatic coffee. In this case, more coffee beans will be ground and brewed halfway through brewing.

- Touch the sensor button while making your coffee.

fold here

### Making two portions (sensor button)

To fill 2 cups at the same time:

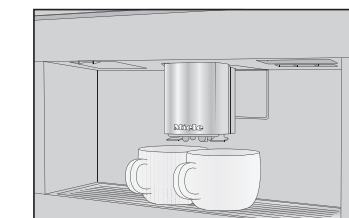

- Place a cup under each of the coffee dispensers in the main dispenser.
- Touch the sensor button while making your drink.

### Using the milk flask

Milk is not cooled in the milk flask. Therefore, place the milk flask in the refrigerator if you are not going to use milk for a while. Good milk froth can only be made with cold milk (< 50°F/10°C).

- Fill the milk flask with milk up to a maximum of 3/4" (2 cm) below the rim.

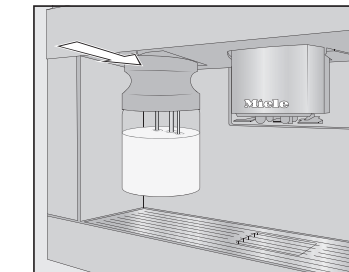

- Push the milk flask back into the coffee machine until it clicks into place. You can now make drinks with milk.

fold here

### Making tea

Hot water is heated to the optimum temperature for different types of tea. Tap the sensor button to access the menu containing the various types of tea.

- Place the tea filter or the tea bag in the tea cup.
- Place the tea cup under the main dispenser.
- Select the type of tea you want and confirm your choice with OK.

Hot water will be dispensed into the cup.

- Remove the tea filter or tea bag when the desired brewing time has elapsed.

**Tip:** You can use the TeaTimer function to start a kitchen timer when making tea (see the operating instructions).

### Pot function

You can make several cups of coffee or tea one after the other automatically with the pot function (maximum of 1 l). Up to 8 cups can be made in this way.

### Preparing the pot

The drinks menu is displayed.

- Place a sufficiently large container under the main dispenser.
- Select the required pot function:
  - **Coffee pot:** Tap the sensor button and select Coffee Pot.
  - **Teapot:** Touch the drinks sensor and select Tea Pot.

- Confirm with OK.
- Select the number of cups you want (3 to 8).
- Follow the instructions in the display.

fold here

### Expert mode

The Expert Mode function allows you to change the portion size while the drink is being made (Settings | Expert Mode).

The setting will **not** be saved and will only apply to the current drink.

The Expert mode function is switched off as the factory default setting.

### Changing the portion size

The portion size can only be changed during the individual preparation stages.



- While the drink is being made, move the indicator (small triangle) across the navigation area to the desired position.

fold here

## Cleaning and care

Please observe the detailed information on cleaning and care in the operating instructions. Carefully clean the coffee machine regularly.

Recommended frequency	What do I have to clean/maintain?
<b>Daily</b> (at the end of the day)	<ul style="list-style-type: none"> <li>- Milk flask and lid</li> <li>- Milk valve</li> <li>- Water container</li> <li>- Drip tray cover</li> <li>- Drip tray and grounds container</li> </ul>
<b>Once a week</b> (more often if heavily soiled)	<ul style="list-style-type: none"> <li>- Main dispenser</li> <li>- Cup rim sensor</li> <li>- Interior</li> <li>- Brew unit</li> <li>- Drip tray</li> <li>- Appliance front</li> </ul>
<b>Once a month</b>	<ul style="list-style-type: none"> <li>- Bean containers</li> </ul>
<b>As and when required/after prompt appears in display</b>	<ul style="list-style-type: none"> <li>- Milk pipework</li> <li>- Degrease the brew unit</li> <li>- Descale the appliance</li> </ul>

### Cleaning by hand or in the dishwasher

#### Clean the following by hand only:

- Stainless steel cover of the main dispenser
- Brew unit
- Bean containers and lids

#### The following parts are dishwasher-safe:

- Drip tray, lid, and grounds container
- Drip tray cover
- Main dispenser (without stainless steel cover)
- Milk flask and lid
- Cup rim sensor
- Drip tray
- Maintenance container
- Water container

MAKING DRINKS

fold here

fold here

fold here

fold here

fold here

fold here

**Cleaning the main dispenser**

Clean the main dispenser stainless steel cover **by hand** only.

- Open the appliance door.

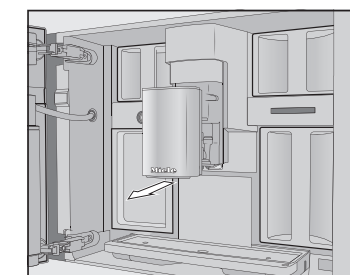

- Remove the main dispenser stainless steel cover and clean it.

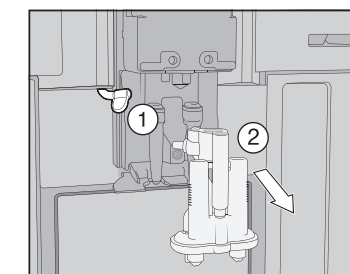

- Detach the milk pipework from the dispensing unit ①. Pull the dispensing unit down to remove it ②.

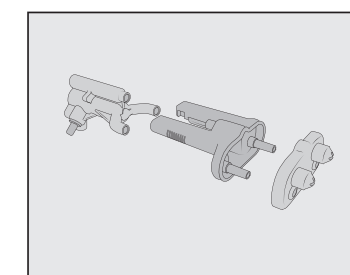

- Disassemble the dispensing unit into 3 parts.
- Clean all parts thoroughly. Clean the surfaces of the main dispenser with a damp cloth.

- Reassemble the dispensing unit.
- Push the dispensing unit back into the main dispenser and replace the stainless steel cover.
- Confirm the message with **OK**.

**Removing the brew unit and cleaning it by hand**

Only clean the brew unit by hand with warm water. Do not use any cleaning agents.

- Open the appliance door and remove the water container.

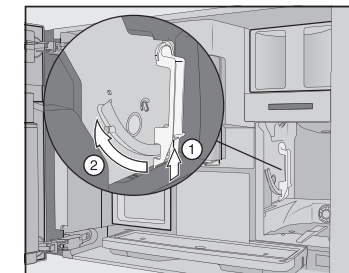

- Press the button under the handle of the brew unit ① and, while doing so, turn the handle forward ②.

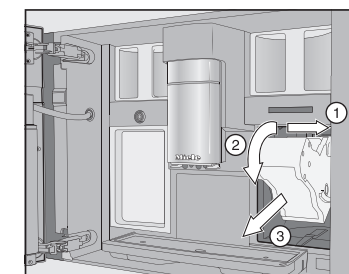

- Pull the brew unit to the side ① first and then pull out to the front ②. Tilt the brew unit forward ③.

Once you have removed the brew unit, do not change the position of the handle on the brew unit.

- Clean the brew unit **by hand** under warm running water.

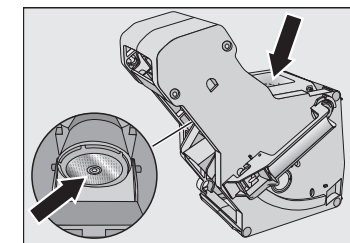

- Wipe any remaining coffee off the filters (see arrows).
- Dry the funnel in the brew unit.
- Carefully clean the inside of the coffee machine.
- Push the brew unit back into the coffee machine.
- Lock the brew unit: Press and hold the button under the brew unit handle and, while doing so, turn the handle to the right.
- Close the appliance door.
- Follow the additional instructions given in the display.

- Follow the additional instructions given in the display.

The process is complete when rinsing has finished.

**Descaling the appliance**

You will need 2 descaling tablets for the descaling program.

Descaling the appliance will appear in the display.

- Tap **OK**.
- The maintenance program will then start.
- Follow the instructions in the display.

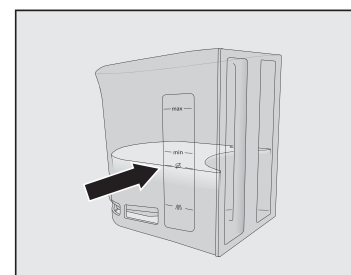

- Fill the water container to the descaling symbol ③ with lukewarm water.
- Drop 2 descaling tablets in the water.
- Reinsert the water container.
- Follow the additional instructions given in the display.

When Place 2 descaling tablets in the water container and fill it with lukewarm water up to the descaling symbol ③ and insert it. Close the door. appears in the display, proceed as follows.

- Remove the water container and rinse it thoroughly with clean water. Fill the water container to the descaling symbol ③ with fresh drinking water.

The descaling process is complete when rinsing has finished.

**Coffee drinks**

- **Ristretto** is a concentrated, stronger espresso. It is prepared with the same amount of coffee as for an espresso but with a lot less water.
- **Espresso** is a strong aromatic coffee with a thick, hazelnut-brown colored froth – known as the crema – on top.
- **Coffee** differs from espresso by the increased amount of water and the roast of the beans.
- **Lungo** is a coffee with significantly more water.
- **Long black** is made with hot water and two shots of espresso.
- **Caffè Americano** consists of equal proportions of espresso and hot water. The espresso is made first, then the hot water is dispensed.

**Coffee drinks made with milk**

- **Cappuccino** consists of approx. 2 thirds milk froth and 1 third espresso.
- **Latte macchiato** consists of 1 third each of hot milk, milk froth, and espresso.
- **Caffè latte** consists of espresso and hot milk.
- **Cappuccino Italiano** has the same proportions of milk froth and espresso as a cappuccino. The difference is that the espresso is added first and then the milk froth.
- **Espresso macchiato** is an espresso with a small amount of milk froth on top.
- **Flat white** is a special variety of cappuccino that contains significantly more espresso than milk froth for an intensive coffee aroma.
- **Café au lait** is a French style of coffee consisting of coffee and milk froth. Café au lait is usually served in a bowl.

**Tea drinks**

- (hot water at the optimum temperature)
- White tea
  - Japanese tea
  - Green tea
  - Herbal tea
  - Fruit tea
  - Black tea
  - **Chai Latte** is a tea specialty with milk.

**Other drinks**

- Hot milk
- Milk froth
- Hot water
- Warm water

**Pot function**

- (3 to 8 cups can be selected)
- Coffee pot
  - Teapot for all types of tea

**Displaying and changing parameters**

You can change the portion size for all drinks.

In addition, you can set the amount of coffee, brew temperature, and pre-brewing parameters for each coffee drink individually.

- Touch the sensor button.
- Select a drink and confirm with **OK**.
- Tap Drink parameters.

The parameters that can be changed for this drink are displayed.

The Portion size menu option is displayed in the first line. If you select Portion size and confirm with **OK**, the drink will be dispensed immediately.

- Select a parameter and change the setting as required.
- Confirm with **OK**.

**Portion size**

You can adjust the portion size for all coffee drinks, hot water, all types of tea, and drinks with milk.

- Place a cup under the main dispenser.
- Select Portion size and confirm with **OK**.
- The desired drink will be made and Save will appear in the display.
- When the cup is filled up to the desired level, tap **OK**.

If you want to change the portion size for coffee drinks made with milk or hot water, the ingredients which make up the drink will be saved one after the other while the drink is being made.

**Performance mode**

You can select the appropriate mode to suit your personal preferences under Settings | Performance Mode. The energy consumption varies depending on the selected mode.

- **Eco Mode:** This is an energy-saving mode.
- **Barista Mode:** This mode is optimized for espresso and coffee drinks.
- **Latte Mode:** In this mode, milk-based drinks can be prepared within a much shorter space of time.

In addition, you can activate **Party Mode** for the occasional intensive use of the coffee machine, e.g., for family get-togethers (see the operating instructions).

**Displaying and changing settings**

- Touch the sensor button.
- Select Settings and tap **OK**.
- Select the menu option that you want to display or change. Tap **OK**.
- Change the setting as required and confirm with **OK**.

Factory default settings are marked in *italics*.

**Language**

- German | ... other languages
- Location

**Time**

- Display: On | *Off* | Night dimming
- Time format: 24 h | 12 h (am/pm)
- Set

**Date**

- (Set)

**Timer**

- Timer 1: Switch on at | Switch off at
- Timer 2: Switch on at | Switch off at
- Switch off after (0:20)

**TeaTimer**

- Automatic | *Manual*

**Volume**

- Audible signals
- Keypad tones
- Welcome melody: On | Off

**Display**

- Brightness
- QuickTouch: On | *Off*

**Lighting**

- Appliance switched on
- Appliance switched off: switch off after

You can also specify how long the lighting should stay on for when the appliance is switched off.

**Info**

- Number of drinks (Total no. of drinks | Total coffees | ...)
- No. of uses until maintenance program: Descale the appliance | Degrease the brew unit

**Fresh water (CVA 7445)**

- On | *Off*

**Altitude**

- 0–250 m, 251–500 m, ...

**Performance mode**

- *Eco mode* | Barista mode | Latte mode | Party mode

Party mode is a Performance mode for the occasional intensive use of the coffee machine (see the operating instructions).

**Water hardness**

- Total hardness
- Set to 21 °dH at the factory.

**System lock**

- On | *Off*
- When the system lock is activated, the Turn off after timer cannot be selected.

**Miele@home**

- Set up | Deactivate/Activate | Connection status | New set-up

Some menu options only appear if Miele@home has been set up and the coffee machine is connected to a WiFi network.

**Remote control**

- On | Off

**RemoteUpdate**

- On | Off

**Software version**

For Customer Service

**Showroom program**

- Demo mode: On | *Off*

**Factory defaults**

- Appliance settings: Reset | Do not reset
- Language, Time, Date, Number of drinks, Miele@home settings, Profiles, and the corresponding drinks cannot be reset.

Quick Start Guide

Coffee machine



This Quick Start Guide is not a substitute for the operating instructions supplied with the appliance. It is essential to familiarize yourself with the coffee machine before using it for the first time. Please read the operating instructions carefully and pay particular attention to the IMPORTANT SAFETY INSTRUCTIONS.