

**Miele**



Operating and Installation Instructions  
Commercial Tumble Dryer  
PDR 910 EL  
Electrically heated

---

To prevent accidents and machine damage, read these instructions **before** installation or use.

en-US, CA

M.-Nr. 12 444 240

**⚠ WARNING: FIRE OR EXPLOSION HAZARD**

**Failure to follow safety warnings exactly could result in serious injury, death or property damage.**

**Do not store or use gasoline or other flammable vapors and liquids in the vicinity of this or any other appliance.**

**WHAT TO DO IF YOU SMELL GAS**

**Do not try to light any appliance.**

**Do not touch any electrical switch; do not use any phone in your building.**

**Clear the room, building or area of all occupants.**

**Immediately call your gas supplier from a neighbor's phone. Follow the gas supplier's instructions.**

**If you cannot reach your gas supplier, call the fire department.**

**Installation and service must be performed by a qualified installer, service agency or the gas supplier. (In Massachusetts, installation must be performed by a licensed installer / gas fitter.)**

**To reduce the risk of severe injury or death follow all installation instructions.**

**Do not install a clothes dryer with flexible plastic venting materials. If flexible metal (foil type) duct is installed, use duct that has been investigated and found acceptable for use with clothes dryers. Flexible venting materials are known to collapse, be easily crushed, and trap lint. These conditions will obstruct clothes dryer airflow and increase the risk of fire.**

**Save these instructions.**

**For Your Safety**

**Do not store or use gasoline or other flammable vapors and liquids in the vicinity of this or any other appliance.**

Instructions to be followed in the event the user smells gas and the "For Your Safety" caution above must be posted in a prominent location. The information to be posted shall be obtained by consulting with the local gas supplier.

<b>Caring for the environment</b> .....	<b>7</b>
<b>IMPORTANT SAFETY INSTRUCTIONS</b> .....	<b>8</b>
Appropriate use .....	8
Preventing misuse .....	9
Technical safety .....	9
Correct use .....	12
Accessories .....	13
<b>Description of the machine</b> .....	<b>14</b>
<b>Operating the tumble dryer</b> .....	<b>15</b>
Control panel.....	15
Sensor buttons and touch display with sensor buttons .....	16
Main menu .....	16
“☐ Programs” menu .....	16
“☆ Favorites” menu.....	16
“⚙ Supervisor” menu .....	16
Operating examples .....	16
Option lists .....	16
Setting numerical values .....	17
Pull-down menu.....	18
Exiting the menu .....	18
Help display .....	18
<b>Before using for the first time</b> .....	<b>19</b>
Switching on the tumble dryer .....	19
Reference to optional external machines .....	19
Setting the display brightness .....	20
Setting the date .....	20
Confirming the time-of-day display query .....	20
Selecting program packages.....	21
Completing the initial commissioning process .....	21
<b>Drying</b> .....	<b>23</b>
1. Notes on correct laundry care .....	23
Washing before drying .....	23
Removing foreign objects.....	23
Care symbols.....	23
2. Loading the tumble dryer.....	24
3. Selecting a program.....	24
Switching on the tumble dryer .....	24
4. Selecting program settings .....	25
Selecting the drying level .....	25
Selecting extra options .....	25
5. Starting a program .....	27
Calling up current program parameters .....	27
Program runtime/estimated time remaining .....	27
Program end.....	27
End of the program.....	27
Removing the laundry .....	28
Care notes .....	28
Timer .....	28
Prerequisite for setting the timer .....	28
Setting the timer.....	28

# Contents

---

<b>Program guide</b> .....	<b>29</b>
“Label” program package .....	29
“Standard” program package .....	30
“Sport” program package.....	33
“Flatwork” program package .....	34
“Bedding” program package.....	35
“Cleaning contractors” program package.....	36
“Fire department” program package .....	37
“WetCare” program package.....	38
“Equestrian” program package.....	39
“Special programs” program package.....	40
“Individual programs” program package.....	41
<b>Changing the program sequence</b> .....	<b>42</b>
Changing a program once it has started .....	42
Canceling the current program.....	42
Reselecting a canceled program .....	42
Time left.....	42
<b>Supervisor level</b> .....	<b>43</b>
Opening the Supervisor level.....	43
Access via code .....	43
Change code .....	43
Closing the settings menu .....	43
Controls / Display.....	43
Language.....	43
Language entry.....	43
Set languages.....	44
Display brightness .....	44
Clock display .....	44
Date .....	45
Volume .....	45
Res. moisture display.....	45
Visibility parameters.....	45
Display off status .....	45
Machine off status.....	46
Delay start .....	46
Memory.....	46
Temperature unit.....	46
Weight unit .....	46
Change code .....	46
Program selection .....	47
Controls.....	47
Program packages .....	48
Favorite programs.....	48
Special programs .....	49
Sort programs .....	50
Program color allocation.....	50

Process technology.....	50
Anti-crease .....	50
Drying levels .....	50
Additional cooling .....	51
Cooling down temperature.....	51
Door opening status.....	51
Service .....	51
Clean out the airways .....	51
Clean the filters.....	51
Service interval.....	52
External applications.....	53
External exhaust flap .....	53
Additional fan .....	53
Pressure sensor .....	53
Peak load signal .....	53
Peak load prevention.....	54
Select KOM module.....	54
Availability of Miele digital products .....	54
WiFi / LAN .....	54
Remote.....	54
Remote Update.....	55
Machine parameters.....	56
Legal Information .....	56
<b>Networking.....</b>	<b>57</b>
Pairing instructions .....	57
Opening the supervisor level .....	57
Establishing the network connection via WPS .....	57
Establishing the network connection via soft AP .....	57
Establishing the network connection using a LAN cable.....	57
Technical data .....	58
<b>Cleaning and care .....</b>	<b>59</b>
Cleaning the lint filter.....	59
Removing the lint filter.....	59
Dismantling the lint filter .....	59
Cleaning the lint filter parts (dry).....	60
Cleaning the lint filter parts (wet).....	60
Inserting the lint filter.....	60
Cleaning the air guide .....	61
Rapid cleaning.....	61
Additional cleaning .....	61
Cleaning set .....	64
<b>Frequently asked questions.....</b>	<b>65</b>
Problem solving guide.....	65
<b>Technical Service .....</b>	<b>67</b>
Contact in case of fault.....	67
Optional accessories .....	67
<b>Installation.....</b>	<b>68</b>
Installation requirements .....	68
General operating conditions .....	68

# Contents

---

Installation locations.....	69
Front view .....	69
Side view.....	69
Rear view .....	69
View from above .....	70
Installation on a base .....	70
Installation.....	71
Transporting the tumble dryer .....	71
Leveling the machine .....	71
Electrical connection .....	72
Supply air and exhaust air management.....	73
Ventilation.....	73
Exhaust air management .....	74
Calculating the total ducting length.....	75
Exhaust duct dimensions .....	77
Exhaust air management with plug-in pipes.....	78
Exhaust air management with flexible aluminum hose.....	78
Shared exhaust air duct .....	79
<b>Optional accessories.....</b>	<b>81</b>
Cleaning set .....	81
Communication box.....	81
XKM 3200 WL PLT.....	81
Original spare parts and accessories .....	83
<b>Technical data .....</b>	<b>84</b>

### Disposal of the packaging material

The packaging material protects the dryer from transport damage. The packaging materials used are selected from materials which are environmentally friendly for disposal and can therefore be recycled.

Recycling the packaging material reduces the use of raw materials in the manufacturing process and also reduces the amount of waste in landfill sites. Your dealer will take the packaging material away.

### Disposing of your old machine

Old electrical and electronic machines often contain valuable materials. However, they also contain harmful substances which were essential for their correct functioning and safety. These could be hazardous to human health and to the environment if disposed of with household waste or if handled incorrectly. Therefore, please do not dispose of your old machine with household waste.

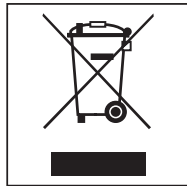

Please dispose of it at your local community waste collection/recycling center for electrical and electronic machines. Consult your dealer if necessary.

Please ensure that your old machine poses no risk to children while being stored for disposal.

# IMPORTANT SAFETY INSTRUCTIONS

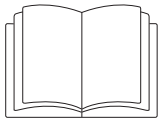

- ▶ It is essential to read these instructions.

This tumble dryer complies with all current local and national safety requirements. Inappropriate use can, however, lead to personal injury and material damage.

Read the Operating Instructions carefully before using the tumble dryer. They contain important information on safety, installation, use, and maintenance. This prevents both personal injury and damage to the tumble dryer.

In accordance with standard UL 60335-1, CAN/CSA-C22.2 No. 60335-1, IEC 60335-1, Miele expressly and strongly advises that you read and follow the instructions in the chapter on installing the tumble dryer as well as the IMPORTANT SAFETY INSTRUCTIONS.

Miele cannot be held liable for injury or damage caused by non-compliance with these instructions.

Keep these Operating Instructions in a safe place and pass them on to any future user.

When instructing other people how to use the tumble dryer, they must be made aware of these IMPORTANT SAFETY INSTRUCTIONS.

## Appropriate use

This tumble dryer complies with current safety requirements. Inappropriate use can, however, lead to personal injury and material damage.

It is essential to read these operating instructions before using the tumble dryer for the first time. They contain important information for your safety, as well as information on using and maintaining the tumble dryer. This prevents both personal injury and damage to the appliance.

- ▶ The tumble dryer is designed for industrial use only.
- ▶ The tumble dryer is intended exclusively for drying textiles washed in water which have been labeled as suitable for tumble drying by the manufacturer on the care label. Any other applications may be dangerous. Miele cannot be held liable for damage resulting from incorrect or improper use or operation.
- ▶ This tumble dryer is not intended for outdoor use.
- ▶ The tumble dryer must not be used in a non-stationary location (e.g., on a ship).
- ▶ Do not install the tumble dryer in a room where there is a risk of frost. At temperatures around freezing point, the tumble dryer may not be able to operate properly. The permitted room temperature is between 40°F and 95°F (2°C and 40°C).
- ▶ If the machine is operated in the commercial sector, it may only be operated by trained or qualified personnel. If the machine is operated in an unsecured location, the supervisor must ensure that its use does not pose a risk.
- ▶ The tumble dryer should only be used by people with reduced physical, sensory, or mental capabilities, or lack of experience or knowledge, if they are supervised while using it or have been shown how to use it in a safe way and understand and recognize the consequences of incorrect operation.
- ▶ Children must be kept away from the tumble dryer unless they are constantly supervised.
- ▶ Children may only use the tumble dryer without supervision if they have been shown how to use it in a safe manner. Children must be able to understand and recognize the possible dangers caused by incorrect operation.
- ▶ Children must not be allowed to clean or maintain the tumble dryer unsupervised.



## IMPORTANT SAFETY INSTRUCTIONS

- ▶ Children should be supervised in the vicinity of the tumble dryer. Never allow children to play with the tumble dryer.
- ▶ Uses other than those listed above are not recommended and shall release the manufacturer from liability.

### Preventing misuse

- ▶ Do not make any alterations to the tumble dryer, unless authorized to do so by Miele.
- ▶ Do not lean on the dryer door. Otherwise, the tumble dryer may tip over, causing injury to yourself or others.
- ▶ Do not use a pressure washer or hose to clean the tumble dryer.
- ▶ The tumble dryer must be serviced in a timely and professional manner. Otherwise, there is a potential risk of loss in performance, faults, and fire.
- ▶ Do not store or use gasoline, petrol, paraffin, or other highly flammable liquids near the tumble dryer. Risk of fire and explosion.
- ▶ Do not expose the tumble dryer to air which contains chlorine, fluorine, or other solvent vapors. This contaminated air can cause a fire.
- ▶ To prevent the risk of fire, the following items must not be dried in the tumble dryer:
  - Items which have not been washed.
  - Items which have not been thoroughly cleaned and are still soiled with grease, oil, or other deposits (such as kitchen linens or cosmetics cloths with cooking oils, grease, lotions, etc). If items have not been thoroughly cleaned, there is a danger that they might ignite when heated, even after they have been removed from the tumble dryer at the end of the program.
  - Items (e.g., mops and floor cloths) that have been treated with inflammable cleaning agents or which contain residues of acetone, alcohol, benzene, petrol, kerosene, stain remover, turpentine, wax and wax remover, or other chemicals.
  - Items which have been soiled with hair lacquer, hair spray, nail polish remover, or similar substances.

Wash heavily soiled items thoroughly by increasing the amount of detergent and selecting a high washing temperature. If in doubt, wash the items several times.

- ▶ The drum-door hinges and the lint-filter compartment cover pose a risk of crushing and shearing. Always use the handles and quick-release catches provided.
- ▶ Always make sure that the drum is stationary before reaching in to remove laundry. Do not touch the drum while it is still rotating.
- ▶ **Warning:** Never switch the tumble dryer off before the end of the drying program. If you absolutely must interrupt the program, remove all items immediately and spread them out to cool down.
- ▶ Never operate the tumble dryer without the lint filter or with a damaged lint filter. This could lead to malfunctions. Lint can clog the air passages, heating elements, and ducting, which could result in a fire. In this case, stop the tumble dryer immediately and replace the damaged lint filter.

### Technical safety

- ▶ The tumble dryer should only be installed and commissioned by Miele Customer Service or an authorized dealer.
- ▶ Before installing the dryer, check it for visible signs of damage. A damaged tumble dryer must not be installed or operated.
- ▶ Do not make any alterations to the tumble dryer, unless authorized to do so by Miele.

## IMPORTANT SAFETY INSTRUCTIONS

---

- ▶ Do not connect the dryer to the electrical supply by an extension cord (risk of fire due to overheating).
- ▶ Do not operate the tumble dryer in a room where cleaning machines operate with solvents containing CFCs. During combustion, any vapors that are emitted will break down into hydrochloric acid, leading to consequential damage affecting laundry and the machine. Air exchange must not take place between rooms if machines are set up in separate rooms.
- ▶ Fire hazard due to controllable socket. This tumble dryer must not be connected to a controllable socket (e.g., a timer). There is a risk of the laundry self-igniting if the tumble dryer's cooling phase is interrupted.
- ▶ The electrical safety of this dryer can only be guaranteed when continuity is complete between it and an effective grounding system. It is essential that this standard safety requirement is observed and regularly tested. If in any doubt, please have the electrical installation inspected by a qualified electrician. Miele cannot be held liable for the consequences of an inadequate grounding system.
- ▶ The tumble dryer is only electrically disconnected from the power supply if
  - the electrical plug has been disconnected from the socket.
  - it is switched off at the main switch, or the electrical fuse is disconnected (on site).
- ▶ The electrical plug must be easily accessible so that the tumble dryer can be disconnected from the power supply at any time. The operator must be able to check from any access point that the electrical plug is still removed.
- ▶ If the appliance is hard wired, protective measures must be made on site to disconnect the tumble dryer from the electrical supply.
- ▶ If the power cord is damaged, it should be replaced by a Miele authorized technician in order to protect the user from harm.
- ▶ Tumble dryers with damaged control elements, wires, or cords must not be used until they have been repaired.
- ▶ Unauthorized repairs could result in unforeseen dangers for the user, for which Miele cannot accept liability. Repairs should only be carried out by a Miele authorized technician, otherwise any subsequent damage may not be covered by the warranty. Repair instructions can be requested from Miele.
- ▶ Faulty components should only be replaced by Miele original parts. Miele may only guarantee the safety standards of the machine when Miele replacement parts are used.
- ▶ Only operate the tumble dryer when all removable outer panels are in place so that it is impossible to touch an electrical component or moving part.
- ▶ During the drying process, the door glass and the frame around the drum door will get hot. Please be aware that the laundry may also be hot if it is removed from the tumble dryer before the end of the drying program.
- ▶ To ensure the correct performance of the tumble dryer and to prevent malfunctions and fire hazards, it is important to carry out maintenance on a regular basis.
- ▶ In the event of a fault and for cleaning and care purposes, the tumble dryer must be disconnected from the power supply. The tumble dryer is only disconnected from the power supply, if:
  - the plug is withdrawn, or
  - the breakers are disconnected, or
  - the breakers have been completely removed.
- ▶ If the heater element malfunctions, accessible parts can get very hot.
- ▶ The tumble dryer may not be used in mobile installations (e.g., on ships).
- ▶ Follow the instructions in "Installation" and "Technical data".

## IMPORTANT SAFETY INSTRUCTIONS

- ▶ Only allow clean, fresh air to be fed into the tumble dryer. Air entering the machine must not contain vapors with chlorine, fluorine or other solvents.
- ▶ The tumble dryer may only be operated when the ducting has been installed and the room is sufficiently ventilated in accordance with all local codes.
- ▶ The ducting must never be installed in any of the following flues or shafts:
  - Chimneys or smokestacks that are in use.
  - Shafts that are used to ventilate installation rooms with fireplaces.
  - Flues that are used by third parties.

Smoke or exhaust gas that is fed back into the flue or shaft may be toxic.

- ▶ Regularly check all components in the ducting (e.g., wall pipe, external grille, bends, elbows, etc.) to make sure that air can move through them and to ensure that they are working properly. Clean components when necessary. Lint deposits in the ducting system will prevent the air from being extracted properly and, as a result, will stop the tumble dryer from working properly.

If existing ducting is due to be used, it must be checked before being installed in the tumble dryer.

Low pressure must not occur in the ducting.

- ▶ There is a risk of suffocation and poisoning due to exhaust gases being sucked back if gas-powered flow heaters, gas-powered room heaters, coal-burning stoves with a flue connection, etc., are installed in the same room, in the same apartment, or in neighboring rooms and the negative pressure is 4 Pa or more.

The following measures for suitable room ventilation (examples) can help to prevent negative pressure in the installation area:

- Install vents that cannot be closed in the exterior walls.
- Use window switches so that the tumble dryer can only be switched on when a window is open.

Always seek approval from the appropriate authority (gas installer, chimney sweep, etc.) to confirm that the machine can be operated without risk and that negative pressure of over 4 Pa can be prevented.

- ▶ If multiple tumble dryers are to be connected to one exhaust air duct, a non-return flap must be installed directly on the duct for each tumble dryer.

If this requirement is not observed, the tumble dryers may be damaged and their electrical safety could be affected.

- ▶ Follow the instructions in “Installing the ducting”.
- ▶ Do not block the gap between the bottom of the tumble dryer and the floor with toe-kicks, deep pile carpet, etc.
- ▶ Ensure that no closeable door, sliding door, or an oppositely hinged door is installed that would hinder the drum door being opened in any way.
- ▶ This tumble dryer is supplied with a special bulb to cope with particular conditions (e.g., temperature, moisture, chemical resistance, abrasion resistance, and vibration). This special bulb must only be used for the purpose for which it is intended. It is not suitable for room lighting. Replacement lamps should only be installed by a Miele authorized technician or by Miele Customer Service.
- ▶ The dryer, when installed, must be electrically grounded in accordance with local codes or, in the absence of local codes, with the National Electrical Code, ANSI/NFPA 70, or the Canadian Electrical Code, CSA C22.1.
- ▶ The dryer must not be installed or stored in an area where it will be exposed to water and/or weather.

## IMPORTANT SAFETY INSTRUCTIONS

---

▶ Caution: Label all wires prior to disconnection when servicing controls. Wiring errors can cause improper operation.

### Correct use

- ▶ Do not damage, remove, or bypass the safety features and control elements of the tumble dryer.
- ▶ Always close the drum door after each drying cycle. This will prevent:
  - Children climbing into the tumble dryer or hiding things in it.
  - Pets or other small animals climbing into the tumble dryer.
- ▶ Do not use a pressure washer or hose to clean the tumble dryer.
- ▶ Keep the room where the tumble dryer is located free from dust and lint. If the air that is taken into the machine contains dirt particles, this can cause blockages. A fault may then occur and there is a risk of fire.
- ▶ The lint filter must be cleaned on a regular basis.
- ▶ To ensure problem-free operation of the tumble dryer:
  - Remove the lint from the lint filter after every drying cycle.
  - In addition, the lint filter and the air passages must be cleaned when prompted by the display.
- ▶ To prevent the risk of fire, the following items must not be dried in the tumble dryer:
  - Items which have not been washed.
  - Items which have not been thoroughly cleaned and are still soiled with grease, oil, or other deposits (such as kitchen linens or cosmetics cloths with cooking oils, grease, lotions, etc). If items have not been thoroughly cleaned, there is a danger that they might ignite when heated, even after they have been removed from the tumble dryer at the end of the program.
  - Items (e.g., mops and floor cloths) that have been treated with inflammable cleaning agents or which contain residues of acetone, alcohol, benzene, petrol, kerosene, stain remover, turpentine, wax and wax remover, or other chemicals.
  - Items which have been soiled with hair lacquer, hair spray, nail polish remover, or similar substances.

Wash heavily soiled items thoroughly by increasing the amount of detergent and selecting a high washing temperature. If in doubt, wash the items several times.

- ▶ Do not install the tumble dryer in a room where there is a risk of frost. At temperatures around freezing point, the tumble dryer may not be able to operate properly. The permitted room temperature is between 40°F and 95°F (2°C and 40°C).
- ▶ Remove all items from the pockets of the laundry to be dried (e.g., lighters, matches, keys).
- ▶ **Warning:** Never switch the tumble dryer off before the end of the drying program. If you absolutely must interrupt the program, remove all items immediately and spread them out to cool down.
- ▶ Fire hazard due to controllable socket. This tumble dryer must not be connected to a controllable socket (e.g., a timer). There is a risk of the laundry self-igniting if the tumble dryer's cooling phase is interrupted.
- ▶ The program finishes when the cooling phase starts. Many programs are followed by a cooling phase to ensure that the items are not too hot to handle when you remove them (this also reduces the risk of the laundry self-igniting). Always remove all items of laundry from the dryer immediately after the cooling phase.
- ▶ Fabric softener and similar products must be used according to the instructions on the manufacturer's packaging.

## IMPORTANT SAFETY INSTRUCTIONS

- ▶ Do not store or use gasoline, petrol, paraffin, or other highly flammable liquids near the tumble dryer. Risk of fire and explosion.
- ▶ Do not expose the tumble dryer to air which contains chlorine, fluorine, or other solvent vapors. This contaminated air can cause a fire.
- ▶ For machine parts made from stainless steel:  
Avoid contact between stainless steel surfaces and liquid detergents or disinfecting agents which contain chlorine or sodium hypochlorite. These agents can cause corrosion on stainless steel.  
Aggressive chlorine bleach vapors can also be corrosive.  
Do not store open containers of these agents near the machines.

### Accessories

- ▶ Only use genuine Miele spare parts and accessories with this machine. Using parts or accessories from other manufacturers may invalidate the warranty, and Miele cannot accept liability.
- ▶ If you order a plinth for this tumble dryer (available from Miele as an optional accessory), make sure it is the correct one.

 Miele cannot be held liable for damage caused by failure to comply with these IMPORTANT SAFETY INSTRUCTIONS.

### Taking the tumble dryer out of service

- ▶ Before disposing of a tumble dryer it is important to disable the door lock. This way you will prevent the risk of children accidentally locking themselves in and endangering their lives.

## Description of the machine

### PDR 910 (electrically heated)

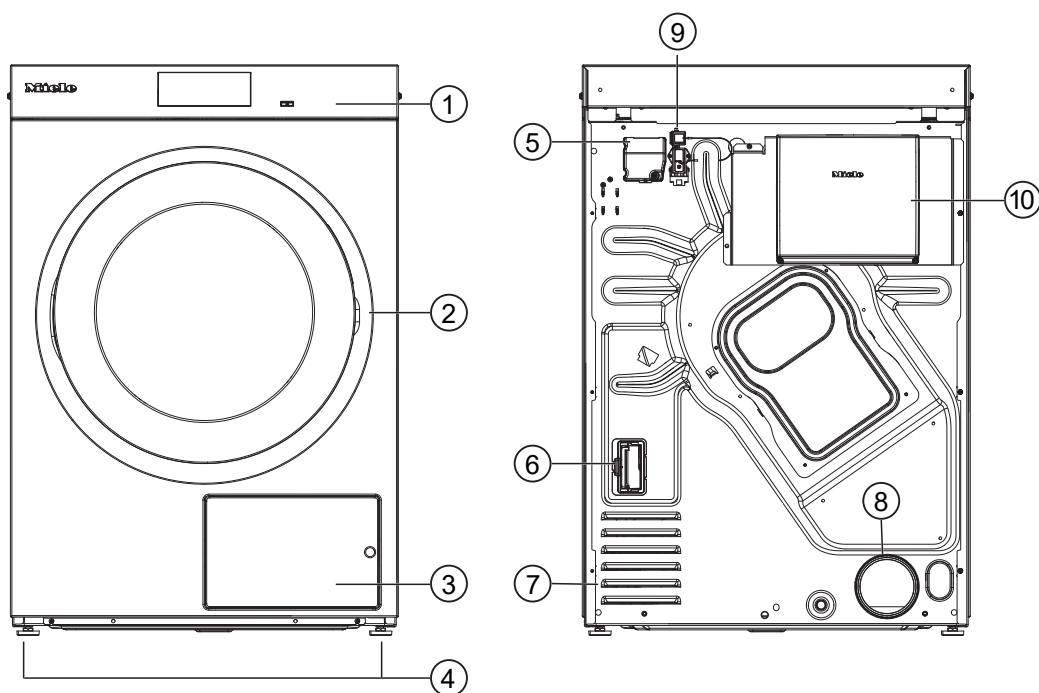

- ① Control panel with touch display
- ② Door
- ③ Lint filter flap
- ④ 4 height-adjustable screw feet
- ⑤ Electrical connection
- ⑥ Communication module slot
- ⑦ Intake vents for drying air
- ⑧ Exhaust duct Ø 4" (100 mm)
- ⑨ Connection for communication box
- ⑩ Communication box (optional)  
For setting up a connection with external systems

## Control panel

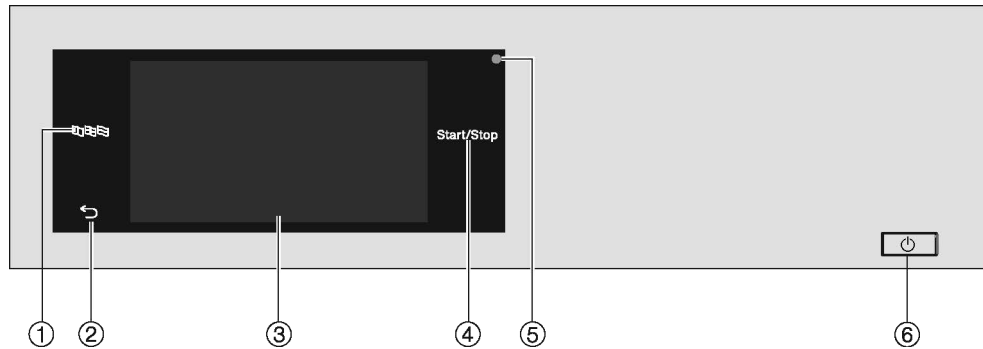

① **Language sensor control** 

For selecting the current user language

At the end of the program, the language is automatically reset to the language set at the Supervisor level.

② **Back sensor control** 

Takes you back one level in a menu.

③ **Touch display**

④ **Start/Stop sensor control**

For starting the selected drying program and canceling a program once it has started. The program selected can be started as soon as the sensor control starts flashing.

⑤ **Optical interface**

Used for data transfer by Miele Service.



⑥ **button**

For switching the tumble dryer on and off. Depending on the programming at supervisor level, the tumble dryer switches off automatically to save energy. It is switched off an adjustable time after the end of the program/Anti-crease phase, or after being switched on if no further selection is made.



# Operating the tumble dryer

## Sensor buttons and touch display with sensor buttons

The , , and *Start/Stop* sensor buttons and the sensor buttons in the display react to finger-tip contact. Every tap of a sensor button is confirmed with an audible keypad tone. You can adjust the volume of the keypad tone or switch it off (see “Supervisor level”).

The control field with sensor buttons and the touch display can be scratched by pointed or sharp objects, e.g., pens.  
Only touch the control field with your fingers.

## Main menu

After switching on the tumble dryer, the main menu will appear in the display. You can access all the important sub-menus from the main menu.

Touch the  sensor button at any time to return to the main menu. Values set previously are not saved.

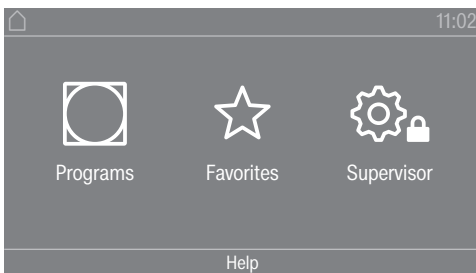

Main menu

### “ Programs” menu

In this menu, you can select the drying programs.

### “ Favorites” menu

In this menu, you can select 1 favorite program from a total of 12 favorite programs. The drying programs can be set up and saved by the supervisor in the Favorites menu (see “Favorite programs” under “Supervisor level”).

### “ Supervisor” menu

You can alter the tumble dryer’s electronic to suit changing requirements in the supervisor level (see “Supervisor level”).

## Operating examples

### Option lists

Scrolling through the “ Programs” menu (single selection)

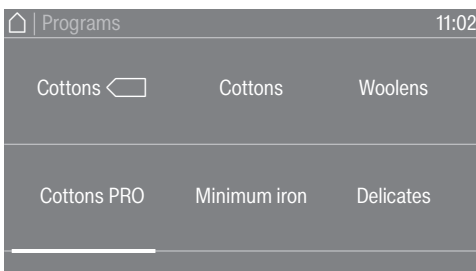

- To scroll through the menu, place your finger on the touch display and move it left or right.



The orange scroll bar in the bottom display area shows that there are further options to choose from.

- To select the required drying program, touch the program name with your finger.

The display will now change to the standard menu for that program.

“Extras” menu (multiple selection)

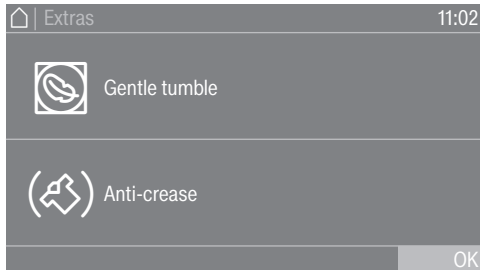

To select one or more *Options*, touch the required *Options* with your finger.

Currently selected *Options* are highlighted orange. To deselect an *option*, simply touch the *option* again.

### Setting numerical values

You can set numerical values in some menus. You can set the numerical values by swiping your finger up and down on the display.

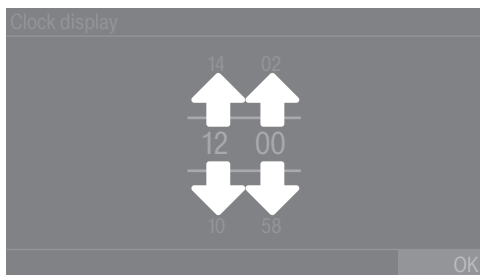

- Place your finger on the number that you want to change.
- To set the required number, swipe your finger up or down on the display.
- Confirm the set numerical value by touching the OK sensor button.

**Tip:** For some settings, depending on the value range and increments, the value can also be set using a numerical keypad. Briefly touching the numbers will bring up the numerical keypad. Once a valid number has been entered, the OK sensor button will be highlighted green.

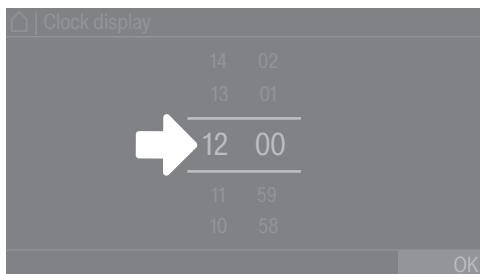

- Briefly touch a number between the two lines with your finger. The numeric block will flash.

# Operating the tumble dryer

---

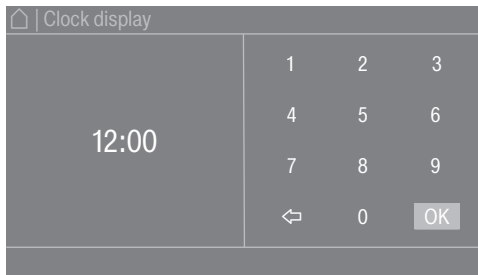

- To enter the numerical value, touch the numbers on the right-hand side and then confirm with OK.

## Pull-down menu

The pull-down menu can be used to display information (e.g., about a drying program).

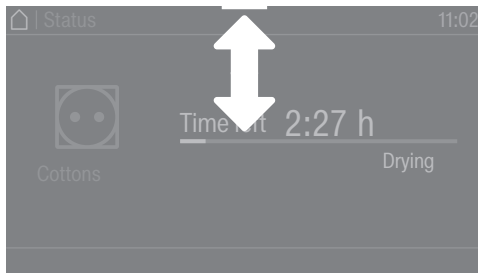

If an orange bar appears at the top of the screen in the middle of the display, you can open the pull-down menu. Touch the bar and drag down with your finger.

To close the pull-down menu again, touch the orange bar and drag it upward with your finger.

## Exiting the menu

- Tap the  sensor button to return to the previous screen.

Entries made before this which have not been confirmed with OK will not be saved.

## Help display

With some menus, Help appears along the bottom line of the display.

- If you need more information about the current menu, touch the Help sensor button. The additional information is shown in the display.
- Touch the  sensor button to return to the previous screen.

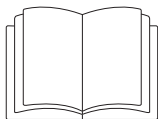

**⚠ Risk of injury or damage to property due to improper installation.** Incorrect installation of the tumble dryer can lead to personal injury or damage to property.  
Before using the tumble dryer for the first time, make sure it has been installed and connected correctly.  
See the information in the section on “Installation”.

Complete the initial commissioning process. During the initial commissioning process, you will need to define the settings for daily use of the tumble dryer. Some settings can only be modified during the initial commissioning process. After that, they can only be changed by Miele Service.

These settings are also described under “Supervisor level”.

### Switching on the tumble dryer

- Press the  button.

The welcome screen will light up.

### Setting the display language

You will be asked to select the display language. You can change the language at any time (see “Language” under “Supervisor level”).

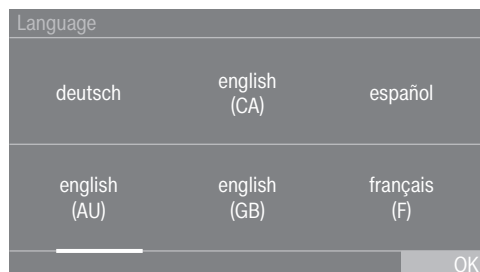

- Swipe left or right across the display with your finger until the language you want appears.
- Briefly touch the required language with your finger.

The selected language will be highlighted in orange and the display will change to the next setting.

### Reference to optional external machines

If there are external devices (e.g., peak-load systems), connect the communication box and/or slide a communication module into the slot on the back of the tumble dryer before initial commissioning. For this purpose, the tumble dryer must be disconnected from the power supply. Then start the commissioning process.

A reference to optional external hardware appears. Confirm the information with the  sensor control.

## Before using for the first time

---

### Setting the display brightness

You will be asked to select the brightness of the display.

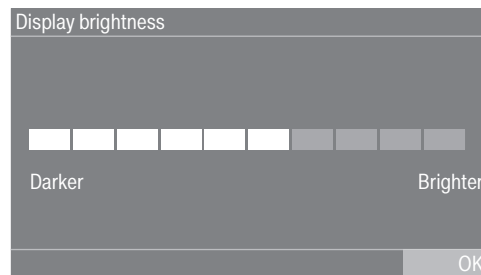

- Touch the segment bar for the required level of brightness. The selected level of brightness is represented by the length of the segment bar.
- Confirm with the OK sensor button. The display will change to the next setting.

### Setting the date

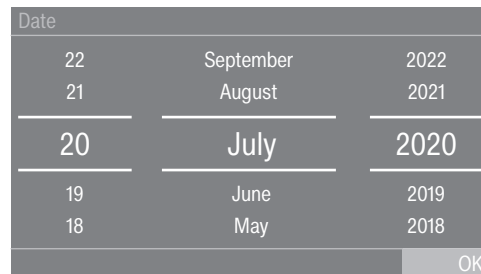

- Place your finger on the value that you want to change and move your finger upward or downward.
- Once all values have been selected, confirm your entry with the OK sensor button.

The display will now change to the next setting.

### Confirming the time-of-day display query

The following question appears in the display: Remove the clock display?

- Touch the Yes or No sensor button.

If you select Yes, the system will skip the Time of Day settings menu.

If you select No, the display will switch to the Time of Day settings menu.

### Setting the time

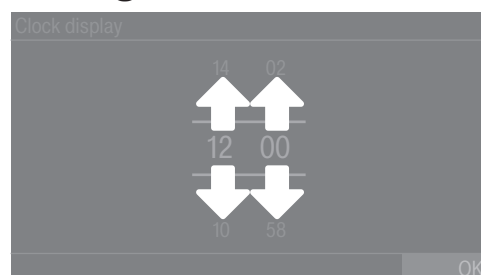

- Place your finger on the number that you want to change and move your finger upward or downward.
- Confirm with the OK sensor button.

The display will change to the next setting.

### Selecting program packages

You can select various programs from the program packages. Any programs already active are highlighted in orange.

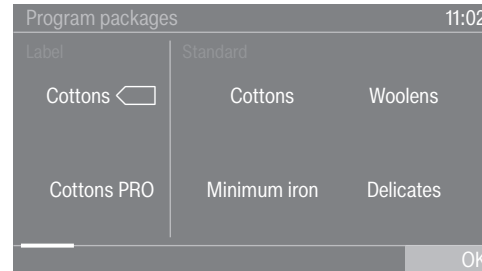

- Swipe to the left until you reach a program that is not highlighted in orange.
- Touch the program to be activated.

The selected program is now active highlighted in orange.

You can select further programs if required.

- If you do not want to select any more programs, confirm with OK.

The display will change to the next setting.

**Tip:** You can disable a selected program by touching the program again. Exception: The Cottons ◀ and Cottons PRO programs cannot be disabled.

### Completing the initial commissioning process

The initial commissioning process is complete when a program lasting longer than 10 minutes has been carried out in full.

If the power is interrupted prior to the start of the first drying program (e.g., if the machine is switched off with the ⏻ button), the initial commissioning process can be completed again. Once a drying program has been running for over 10 minutes, the initial commissioning process cannot be performed again.

- In the main menu, touch the  Programs sensor control.

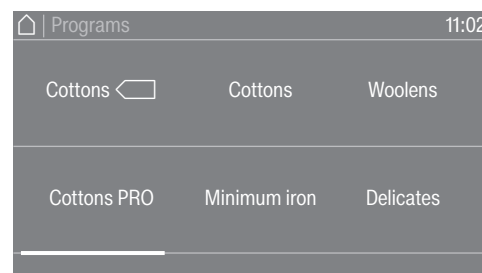

- Swipe to the left until the Timed drying cool air program is displayed.

## Before using for the first time

---

🏠 Programs		11:02
Woolens	Timed drying cool air	Timed warm air hygiene
Delicates	Timed drying warm air	Basket - Low temperature

- Touch the Timed drying cool air program.
- Touch the flashing *Start/Stop* sensor control.

At the end of the program, the tumble dryer is ready for use.

## 1. Notes on correct laundry care

### Washing before drying

Heavily soiled laundry must be washed particularly thoroughly. Use sufficient detergent and select a high wash temperature. If in doubt, wash the items several times.

The tumble dryer must not be used for drying items of laundry which have been cleaned using industrial chemicals.

New, dark, and colored items must be washed thoroughly and separately. Do not dry dark and colored items with light-colored garments. There is the risk of colors running and discoloring other garments or even plastic components in the tumble dryer. Dark-colored fibers can also settle on light-colored garments and vice versa.

### Removing foreign objects

Before drying, ensure that there are no foreign objects in the laundry.

 Damage due to foreign objects which were not removed from the laundry.

Foreign objects in the laundry can melt, burn, or explode.

Ensure that any foreign objects (e.g., detergent dispensing aids, lighters, etc.) have been removed from the laundry.







Check seams and stitching to ensure that padding and linings are intact. This way you will avoid the danger of filling coming out and causing a fire. Sew in or remove underwiring from bras.

 Risk of fire due to incorrect use and operation.

The laundry can burn and destroy the tumble dryer and the surroundings.

Read and observe the "IMPORTANT SAFETY INSTRUCTIONS".

### Care symbols

<b>Drying</b>	
	Normal/higher temperature
	Low temperature*
* Select Low temperature.	
	Do not tumble dry
<b>Ironing</b>	
	Very hot
	Hot
	Warm
	Do not iron

## Loading laundry into the tumble dryer

### 2. Loading the tumble dryer

Laundry may be damaged.  
Before loading, read chapter “1. Notes on correct laundry care” first.

- Open the door.
- Load laundry into the tumble dryer.

Risk of damage with laundry getting trapped.  
Laundry can be damaged by getting trapped when closing the door.  
When closing the door, make sure that laundry does not get trapped in the door opening.

Do not overload the drum. Overloading can cause unnecessary wear and tear to the laundry and cause a disappointing drying result. It can also cause more creasing.

## Closing the door

⚠ Damage caused by laundry getting trapped.  
Laundry can be damaged by getting trapped when closing the door.  
When closing the door, make sure that laundry does not get trapped in the door opening.

- Shut the door gently.

## Switching on the tumble dryer

### 3. Selecting a program

- Press the  button.

The welcome screen will light up.

There are different ways to select a drying program in the main menu.

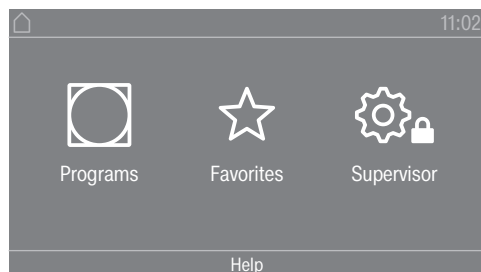

- Touch the  Programs sensor button.

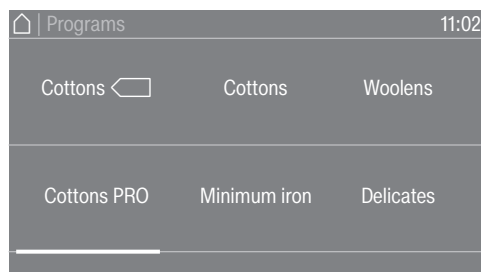

- Swipe to the left until you reach the required program.
- Touch the sensor button for that program.

The display will change to the standard menu for that drying program.



Alternatively, you can select a program from the Favorites list. The pre-set programs under ☆ Favorites can be changed via the Supervisor level.

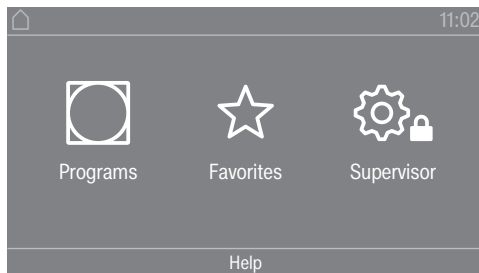

- Touch the ☆ Favorites sensor control.

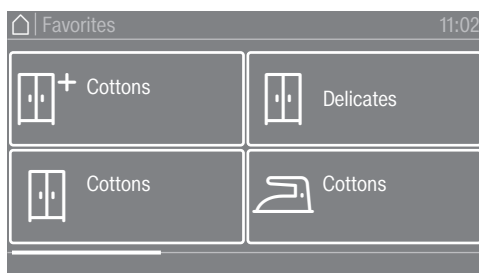

- Swipe to the left until you reach the required program.
  - Touch the required program.
- The display will change to the standard menu for that drying program.

## 4. Selecting program settings

### Selecting the drying level

The pre-set drying level for many programs can be changed if required. Different drying levels are available depending on the program.

### Selecting extra options

The drying programs can be augmented with various Options. Some Options can only be selected for certain drying programs.

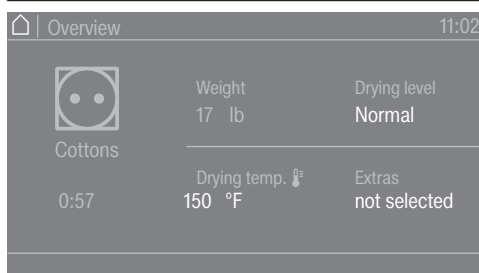

- Touch the Extras sensor button.

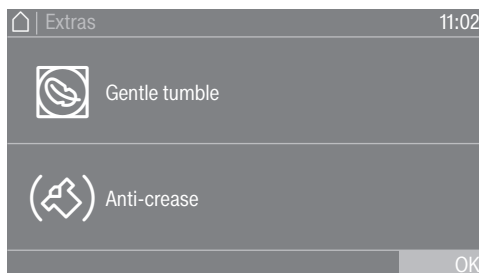

- Touch the sensor button for the option you want.
- Only press OK when the option appears on the display.

## Drying

---

The relevant symbol for the selected option(  or ) lights up.

 Gentle tumble

Sensitive items are dried with fewer drum rotations and a lower drying temperature.

 Anti-crease

After the program has finished, the drum will continue to rotate in a certain rhythm, depending on the selected program. This helps to prevent creasing after the program has ended.

The Anti-crease function is switched off as the factory default setting. The Anti-crease function can be switched on in the supervisor level with a variable duration of up to 12 hours. You can find this setting in the supervisor level under the Process technology/Anti-crease menu.

## 5. Starting a program

**Starting a program** The program can be started as soon as the *Start/Stop* sensor button is flashing on and off.

- Touch the *Start/Stop* sensor button.

If a delay-start period has been selected, this will appear in the display.

The drying program will start either straight away or once the delay-start period has elapsed. The program time left is shown in the display.

### Calling up current program parameters

While the program is running, you can use the pull-down menu to view the parameters of the current drying program (e.g., drying level, load size, selected options, drying temperature).

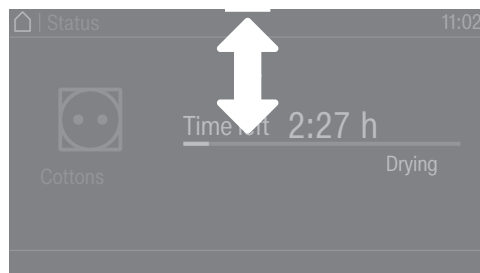

- To call up the pull-down menu, swipe your finger from top to bottom while the program is running.

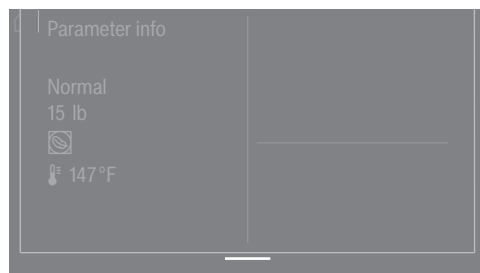

The pull-down menu displays the parameters of the drying program.

- To close the pull-down menu again, swipe your finger from bottom to top or press the ↶ sensor control.

### Program runtime/estimated time remaining

The program runtime depends on the quantity of laundry, the type of fabric, and the residual moisture in the laundry. The displayed program duration for drying level programs can therefore vary or “jump”. The tumble dryer’s electronic adapts during the ongoing drying program. The displayed program runtime becomes more and more accurate.

When using the programs for the first time, the displayed time sometimes deviates significantly from the real time left. The difference between the estimated and achieved time becomes smaller if the corresponding program is run more often. If different load sizes are dried in one program, the time left display can only show an approximate time.

### Program end

# Drying

---

## End of the program

The laundry will be cooled down after the end of the program. The message *Finish/Cooling down* will appear on the display during the cooling phase. The laundry can now be unloaded.

After the cooling phase and the drying program is completed, the message *Finish* is displayed.

The tumble dryer will switch off automatically after the set time after the end of a program.

If the Anti-crease (🌀)\* option has been selected, the drum continues to rotate in intervals after the end of the program. This reduces creasing if the laundry cannot be unloaded straight away.

\* The Anti-crease function is switched off as the factory default setting and can be activated in the supervisor level.

## Removing the laundry

- Open the door.
- Remove everything from the drum.

Items left in the dryer could be damaged by over-drying when the dryer is used the next time.

Always remove all items from the drum.

- Switch the tumble dryer off by pressing the ⏻ button.

## Care notes

This tumble dryer requires regular maintenance, particularly if it is used on a continuous basis. Please see “Cleaning and care” for details.

## Timer





### Prerequisite for setting the timer

The Delay start must be activated in the Supervisor level in the Controls / Display menu so that the Timer can be selected. Before the program starts, the Timer can be used to select a program start time or program end time.

### Setting the timer

- Touch the Timer sensor button.
- Select the *Finish at*, *Start in*, or *Start at* option.
- Set the hours and the minutes and confirm your entry with the OK sensor button.

## “Label” program package

Program name	Suitable fabrics	Selectable drying levels (residual moisture in %)	Selectable extras	Load size
 Cottons 	Cotton items with normal residual moisture	<ul style="list-style-type: none"> <li>- Machine iron (40%)</li> <li>- Hand Iron (25%)</li> <li>- Hand iron plus (15%)</li> <li>- Slightly dry (2%)</li> <li>- Normal (0%)</li> <li>- Normal plus (-2%)</li> <li>- Extra dry (-4%)</li> </ul>	-  Anti-crease*	22 lb (10 kg)
 Cottons PRO	Cotton items with normal residual moisture	<ul style="list-style-type: none"> <li>- Machine iron (40%)</li> <li>- Hand Iron (25%)</li> <li>- Hand iron plus (15%)</li> <li>- Slightly dry (2%)</li> <li>- Normal (0%)</li> <li>- Normal plus (-2%)</li> <li>- Extra dry (-4%)</li> </ul>	-  Anti-crease*	



















\* Can only be selected if the extra is activated in the programmable function at supervisor level.

# Program guide







## “Standard” program package

Program name	Suitable fabrics	Selectable drying levels (residual moisture in %)	Selectable extras	Load size
☐ Cottons	Single and multi-layer cotton/linen items	<ul style="list-style-type: none"> <li>- Machine iron (40%)</li> <li>- Hand Iron (25%)</li> <li>- Hand iron plus (15%)</li> <li>- Slightly dry (2%)</li> <li>- Normal (0%)</li> <li>- Normal plus (-2%)</li> <li>- Extra dry (-4%)</li> </ul>	<ul style="list-style-type: none"> <li>- <input checked="" type="checkbox"/> Gentle tumble</li> <li>- <input checked="" type="checkbox"/> Anti-crease*</li> </ul>	22 lb (10 kg)
☐ Minimum Iron	Minimum iron items made of synthetic, cotton, or mixed fiber	<ul style="list-style-type: none"> <li>- Hand Iron (20%)</li> <li>- Hand iron plus (10%)</li> <li>- Normal (2%)</li> <li>- Normal plus (0%)</li> </ul>	<ul style="list-style-type: none"> <li>- <input checked="" type="checkbox"/> Gentle tumble</li> <li>- <input checked="" type="checkbox"/> Anti-crease*</li> </ul>	9 lb (4 kg)
 Woolens	Woolen items	-	-	
☐ Delicates	Delicate synthetic, cotton, or mixed fiber fabrics	<ul style="list-style-type: none"> <li>- Hand Iron (20%)</li> <li>- Normal (2%)</li> <li>- Normal plus (0%)</li> </ul>	<ul style="list-style-type: none"> <li>- <input checked="" type="checkbox"/> Anti-crease*</li> </ul>	4.5 lb (2 kg)

## Program guide

Program name	Suitable fabrics	Selectable drying levels (residual moisture in %)	Selectable extras	Load size
 Timed Drying, cool air	Items that need airing	-	-  Anti-crease*	22 lb (10 kg)
 Timed Drying, warm air	For drying small loads or for airing individual items	-	-  Gentle tumble -  Anti-crease*	
 Timed Warm air hygiene	For drying small loads or for airing individual items	-	-  Anti-crease*	
 Basket -Low temperature	Items suitable for tumble drying for which mechanical stress should be avoided.	-	-	
 Basket Program	Items suitable for tumble drying for which mechanical stress should be avoided.	-	-	
 Towelling	Particularly absorbent fabrics (e.g., hand towels, flannels, or bathrobes)	- Machine iron (20%) - Hand Iron (12%) - Hand iron plus (8%) - Slightly dry (2%) - Normal (0%) - Normal plus (-2%) - Extra dry (-4%)	-  Anti-crease*	2.2 lb (1 kg)
 Denim	Items made of hard-wearing denim	- Machine iron (40%) - Hand iron plus (8%) - Normal (2%)	-  Gentle tumble -  Anti-crease*	
 Shirts	Shirts	- Machine iron (40%) - Hand Iron (20%) - Slightly dry (8%) - Normal (2%) - Normal plus (0%)	-  Anti-crease*	
 Silks	Silk items	- Machine iron (40%) - Hand Iron (20%) - Hand iron plus (16%) - Slightly dry (8%) - Normal (0%)	-  Anti-crease*	









# Program guide

Program name	Suitable fabrics	Selectable drying levels (residual moisture in %)	Selectable extras	Load size
 Automatic Plus	Mixed loads of garments suitable for the "Cottons" and "Minimum iron" programs	<ul style="list-style-type: none"> <li>- Machine iron (40%)</li> <li>- Hand Iron (25%)</li> <li>- Hand iron plus (15%)</li> <li>- Slightly dry (2%)</li> <li>- Normal (0%)</li> <li>- Normal plus (-2%)</li> <li>- Extra dry (-4%)</li> </ul>	<ul style="list-style-type: none"> <li>-  Gentle tumble</li> <li>-  Anti-crease*</li> </ul>	22 lb (10 kg)
 Smoothing	<ul style="list-style-type: none"> <li>- Cotton and linen fabric</li> <li>- Minimum iron items made of cotton, synthetic, or mixed fiber, e.g., trousers, jackets, shirts</li> </ul>	-	<ul style="list-style-type: none"> <li>-  Gentle tumble</li> <li>-  Anti-crease*</li> </ul>	4.5 lb (2 kg)

\* Can only be selected if the extra is activated in the programmable function at supervisor level.



















## “Sport” program package

Program name	Suitable fabrics	Selectable drying levels (residual moisture in %)	Selectable extras	Load size
 Sportswear	Polyester or polyamide with and without spandex	<ul style="list-style-type: none"> <li>- Machine iron (40%)</li> <li>- Hand Iron (20%)</li> <li>- Hand iron plus (8%)</li> <li>- Slightly dry (2%)</li> <li>- Normal (0%)</li> <li>- Normal plus (-2%)</li> <li>- Extra dry (-4%)</li> </ul>	-  Anti-crease*	9 lb (4 kg)
 Outerwear	Polyamide and membrane items Outdoor clothing which is suitable for tumble drying	<ul style="list-style-type: none"> <li>- Machine iron (40%)</li> <li>- Hand Iron (20%)</li> <li>- Slightly dry (8%)</li> <li>- Normal (2%)</li> <li>- Normal plus (0%)</li> </ul>	-  Anti-crease*	
 Proofing	Items suitable for tumble drying, e.g., microfiber fabrics, skiwear, outdoor clothing, fine, close-weave cotton garments (poplin), tablecloths. <b>Caution: fire hazard!</b> Fabrics proofed with paraffinic agents must not be tumble dried. This program includes an additional proofing fixing phase. Only use proofing agents which are stated by the manufacturer as being “suitable for use on membrane fabrics”.	<ul style="list-style-type: none"> <li>- Machine iron (40%)</li> <li>- Hand Iron (20%)</li> <li>- Slightly dry (8%)</li> <li>- Normal (0%)</li> </ul>	-  Anti-crease*	
 Reactivation	Polyamide and membrane items The drying process revitalizes the fibers, which improves the water-repelling effect.	<ul style="list-style-type: none"> <li>- Machine iron (40%)</li> <li>- Hand Iron (20%)</li> <li>- Slightly dry (8%)</li> <li>- Normal (0%)</li> </ul>	-  Anti-crease*	

\* Can only be selected if the extra is activated in the programmable function at supervisor level.









# Program guide

## “Flatwork” program package

Program name	Suitable fabrics	Selectable drying levels (residual moisture in %)	Selectable extras	Load size
 Cottons, dry plus	Single and multi-layer cotton/linen items	- Extra dry (-4%)	-  Anti-crease*	22 lb (10 kg)
 Cottons, dry	Single and multi-layer cotton/linen items	- Normal (0%)	-  Anti-crease*	
 Cottons 20% res. moisture	Single and multi-layer cotton/linen items	- Hand iron plus (20%)	-  Anti-crease*	
 Cottons 25% res. moisture	Single and multi-layer cotton/linen items	- Hand Iron (25%)	-  Anti-crease*	
 Cottons 40% res. moisture	Single and multi-layer cotton/linen items	- Machine iron (40%)	-  Anti-crease*	
 Minimum Iron, dry	Minimum iron items made of synthetic, cotton, or mixed fiber	- Normal plus (0%)	-  Anti-crease*	9 lb (4 kg)
 Min. Iron 10% res. moisture	Minimum iron items made of synthetic, cotton, or mixed fiber	- Hand iron plus (10%)	-  Anti-crease*	
 Min. Iron 20% res. moisture	Minimum iron items made of synthetic, cotton, or mixed fiber	- Hand Iron (20%)	-  Anti-crease*	

\* Can only be selected if the extra is activated in the programmable function at supervisor level.







“Bedding” program package

Program name	Suitable fabrics	Selectable drying levels (residual moisture in %)	Selectable extras	Load size
 Down Bedding Bedding	Down duvets and pillows	- Normal (0%)	-  Anti-crease*	18 lb (8 kg)
 Synthetic Bedding	Synthetic duvets and pillows	- Normal (0%)	-  Anti-crease*	
 Natural Hair Bedding	Natural fiber duvets and blankets Natural fiber duvets must not be fully dried in the tumble dryer, as otherwise there is a risk of the fibers becoming matted. Partial drying only is recommended.	-	-  Anti-crease*	
 Pillows	Pillows	- Normal (0%)	-  Anti-crease*	

\* Can only be selected if the extra is activated in the programmable function at supervisor level.

# Program guide

## “Cleaning contractors” program package

Program name	Suitable fabrics	Selectable drying levels (residual moisture in %)	Selectable extras	Load size
 Mops	Cotton mops	<ul style="list-style-type: none"> <li>- Machine iron (20%)</li> <li>- Hand Iron (15%)</li> <li>- Hand iron plus (10%)</li> <li>- Slightly dry (2%)</li> <li>- Normal (0%)</li> <li>- Normal plus (-2%)</li> <li>- Extra dry (-4%)</li> </ul>	-  Anti-crease*	18 lb (8 kg)
 Microfiber Mops	Microfiber mops	<ul style="list-style-type: none"> <li>- Machine iron (40%)</li> <li>- Hand Iron (20%)</li> <li>- Normal (2%)</li> <li>- Normal plus (0%)</li> </ul>	-  Anti-crease*	
 Cleaning Cloths	Microfiber cloths, dusters	<ul style="list-style-type: none"> <li>- Machine iron (40%)</li> <li>- Hand Iron (20%)</li> <li>- Normal (2%)</li> <li>- Normal plus (0%)</li> <li>- Extra dry (-2%)</li> </ul>	-  Anti-crease*	9 lb (4 kg)

\* Can only be selected if the extra is activated in the programmable function at supervisor level.

“Fire department” program package

Program name	Suitable fabrics	Selectable drying levels (residual moisture in %)	Selectable extras	Load size
☎ Masks	Breathing masks with head straps  Breathing masks may only be tumble dried if they are held in place in the drum by special holders (optional accessories).	-	-	2 items
👤 Protective Clothing	Protective suits (e.g., Nomex® firefighting apparel), overalls, jackets, trousers  For an optimized drying result, turn the fabrics inside out.	- Normal (2%)	- (☑) Anti-crease*	10 lb (4.5 kg)
👤 Proof Protect. Clothing	Fabrics treated with a proofing agent.  Proofed fabrics may only be used with proofing agents that are suitable for membrane fabrics and are based on fluorochemical compounds.  Close the velcro or cover with Floorband.  <b>Caution: fire hazard!</b> Fabrics proofed with paraffinic agents must not be tumble dried.	- Normal (2%)	- (☑) Anti-crease*	
👤 Safety Clothing	Synthetic fibers and cottons  Close the velcro or cover with Floorband.  For an optimized drying result, turn the fabrics inside out.	- Normal (2%)	- (☑) Anti-crease*	

\* Can only be selected if the extra is activated in the programmable function at supervisor level.

# Program guide





## “WetCare” program package

Program name	Suitable fabrics	Selectable drying levels (residual moisture in %)	Selectable extras	Load size
Ⓜ WetCare Sensitive	Non-washable outerwear	-	- (☞) Anti-crease*	9 lb (4 kg)
Ⓜ WetCare Silks	Non-washable outerwear which creases easily	- Machine iron (40%) - Hand Iron (20%) - Hand iron plus (16%) - Slightly dry (8%) - Normal (0%)	- (☞) Anti-crease*	
Ⓜ WetCare Intensive	Washable outerwear	- Machine iron (40%) - Hand Iron (25%) - Hand iron plus (15%) - Slightly dry (2%) - Normal (0%) - Normal plus (-2%) - Extra dry (-4%)	- (☞) Anti-crease*	

\* Can only be selected if the extra is activated in the programmable function at supervisor level.

## “Equestrian” program package

 Risk of damage due to metal buckles, hooks, and eye fasteners. Metal buckles, hooks, and eye fasteners may damage fabrics and the dryer drum. Remove all metal buckles, hooks, and eye fasteners before tumble drying. If the metal buckles, hooks, and eye fasteners cannot be removed, they must be covered with suitable protective bags (optional Miele accessories).

Program name	Suitable fabrics	Selectable drying levels (residual moisture in %)	Selectable extras	Load size
 Horse Blankets	Horse blankets, saddlecloths, gaiters, hoof boots, bandages, textile halters	<ul style="list-style-type: none"> <li>- Machine iron (40%)</li> <li>- Normal (2%)</li> <li>- Normal plus (0%)</li> </ul>	-  Anti-crease*	18 lb (8 kg) (approx. 5 saddlecloths or 1 summer blanket)
 Wool Horse Blankets	Horse blankets containing a high proportion of wool	-	-  Anti-crease*	

\* Can only be selected if the extra is activated in the programmable function at supervisor level.

## Program guide

---

### “Special programs” program package

You can put together 5 special programs on the machine and assign your own program names. Enter the program names in the table.

Program name	Suitable fabrics	Selectable drying levels (residual moisture in %)	Selectable extras	Load size
☆ Special program 1				≤ 22 lb (10 kg)
☆ Special program 2				
☆ Special program 3				
☆ Special program 4				
☆ Special program 5				



**“Individual programs” program package**

You can put together 20 individual programs in the Miele Benchmark Programming Tool (see “Miele Benchmark Programming Tool Manual”) and assign your own program names. Enter the program names in the table.

Program name	Suitable fabrics	Selectable drying levels (residual moisture in %)	Selectable extras	Load size
☰ 1 Individual program 1				≤ 22 lb (10 kg)
☰ 2 Individual program 2				
☰ 3 Individual program 3				
☰ 4 Individual program 4				
☰ 5 Individual program 5				
☰ 6 Individual program 6				
☰ 7 Individual program 7				
☰ 8 Individual program 8				
☰ 9 Individual program 9				
☰ 10 Individual program 10				
☰ 11 Individual program 11				
☰ 12 Individual program 12				
☰ 13 Individual program 13				
☰ 14 Individual program 14				
☰ 15 Individual program 15				
☰ 16 Individual program 16				
☰ 17 Individual program 17				
☰ 18 Individual program 18				
☰ 19 Individual program 19				
☰ 20 Individual program 20				

## Changing the program sequence

---

### Changing a program once it has started

You cannot change to another program once a program has started (this prevents unintentional alterations). You will need to cancel the current program before you can select a new one.

 Risk of fire due to incorrect use and operation.  
The laundry can burn and destroy the tumble dryer and the surroundings.  
Read and observe the “IMPORTANT SAFETY INSTRUCTIONS”.

### Canceling the current program

- Touch the *Start/Stop* sensor control.

The following message appears in the display: Cancel the program?

- Touch the *Yes* sensor control to cancel the current program.

 Risk of burns by touching hot laundry or the tumble dryer drum.  
Touching the hot laundry or the tumble dryer drum may cause burns.  
Let the laundry cool down and remove it carefully.

Opening the door of the tumble dryer during the program sequence will cancel the current program.

If the *Door opening status/Interrupt* program function is selected in the supervisor level, the current program will be interrupted when the door is opened. In the case of an interruption, the tumble dryer will remain in the current program.

The interrupted program will be continued when the door is closed and the *Start/Stop* sensor control is pressed.

### Reselecting a canceled program

- Open and close the door.
- Select and start a new program.

### Adding laundry during ongoing Delay Start period

You can open the door to add or remove laundry.

- All program settings will be saved.
- You can still change the drying level, if required.
- Open the door.
- Remove or add the laundry.
- Close the door.
- Touch the *Start/Stop* sensor button so that the Delay Start period continues.

### Time left

Altering the program sequence can cause the program duration shown in the display to be adjusted.

## Opening the Supervisor level

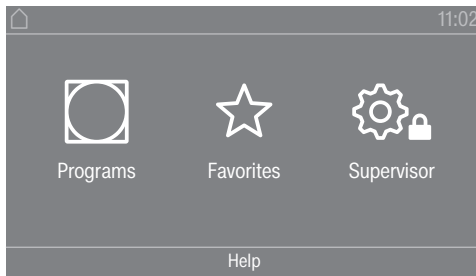

Touching the  sensor button takes you to the Supervisor level.

## Access via code

The supervisor level is accessed using a code.

Factory default: The code is **000**.

## Change code

You can alter the supervisor-level access code to protect the tumble dryer from unauthorized access.

Carefully enter a new code.

Please inform Technical Service if you have forgotten your new code. Technical Service will have to reset the code.

Make a note of your new code and store it in a safe place.

## Closing the settings menu

- Touch the  sensor control.

The display will then go back to the previous menu level.

- Touch the  sensor control.

The display will change to the main menu.

## Controls / Display

### Language

The display can be set to appear in one of several different languages. To select the language you want, go to the *Languages* sub-menu.

You can change the language as follows:

- Permanently using the supervisor level (= “Supervisor language”).
- For the duration of the current program only using the  sensor control. The supervisor language is displayed again at the end of the program.

### Language entry

The display can be set to one of several different user languages. This setting allows you to determine how languages can be selected.

You can change the language as follows:

#### International

6 languages are available. The  sensor button is not active. Note the setting Set languages.

## Supervisor level

---

### Language setting

The  sensor button can be used to select a language. All languages are available (factory default).

You can change the order of the first 4 languages. These slots are allocated to the most commonly used languages.

### Standard language

The user language cannot be changed. The user language is the same as the supervisor language. The  sensor button is not active.

### **Set languages**

The languages for the International lang. entry setting can be changed.

6 languages can be selected. All languages are available.

If you wish to add a new language to the language menu:

- First select the language you want to replace.

All available languages are displayed.

- Select and confirm the language to replace the previous language.

The new language appears instead of the old one.

### **Display brightness**

The brightness of the display can be altered. The setting depends on the various lighting conditions in the place of installation.

- It can be set to one of 10 different levels.

### **Clock display**

After selecting the clock format, you can set the time of day.

#### Clock format

- Factory default: 24-hour display
- 12-hour display
- No clock

#### Set

- The time can be set.

### Date

The date can be set after selecting the date format.

#### - Date format

The date can be shown starting with the day, month, or year.

#### - Date

The date is set.

### Volume

The volume for various sounds can be changed.

The volume can be changed for the following tones:

#### - Finish tone

The finish tone signals the end of the drying program.

#### - Keypad tone

#### - Welcome tone

#### - Fault alarm

The fault tone signals a fault and can be switched off. The volume of the fault tone cannot be adjusted.

### Res. moisture display

In addition to displaying the drying level, the residual moisture can also be indicated as a percentage.

#### - Factory default: Without % value

#### - With % value

### Visibility parameters

Various parameters are offered/displayed when a program is selected. You can decide which parameters should not be displayed. These parameters can then not be edited during program selection.

#### - Residual moisture

#### - Duration

#### - Low temperature

#### - Anti-crease

#### - Load size

#### - Drying temperature

### Display off status

The display switches off to save energy; only the *Start/Stop* sensor control flashes slowly. You can change this setting.

Changing this setting leads to increased energy consumption.

#### - Off

No switching off

#### - On (10 min.) Not curr.prog.

The display will remain on while the program is running but will go out 10 minutes after the end of the program.

## Supervisor level

---

- Logo (10 min.) Not curr.prog.  
The display will remain on while the program is running but the logo will light up 10 minutes after the end of the program.
- Factory default: On after 10 min.  
The display is switched off after 10 minutes.
- On (30 min.) Not curr.prog.  
The display will remain on while the program is running but will go out 30 minutes after the end of the program.
- Logo (30 min.) Not curr.prog.  
The display will remain on while the program is running but the logo will light up 30 minutes after the end of the program.
- On after 30 min.  
The display will go out after 30 minutes.

### Machine off status

In order to save energy, the tumble dryer will switch off automatically after the end of the program or if no further selection is made. You can change this setting.

Changing this setting leads to increased energy consumption.

- No switch off
- Factory default: Switch off after 15 minutes
- Switch off after 20 minutes
- Switch off after 30 minutes

### Delay start

The delay start (timer) can be activated or deactivated.

- Factory default: Off
- On

### Memory

The tumble dryer saves the settings that were selected last for a drying program (drying level and/or extra option, or the duration for some programs).

- Factory default: Off
- On

### Temperature unit

You can select the unit for the temperature display.

- Factory default: °C
- °F

### Weight unit

You can decide whether load quantities are displayed in “kg” or “lb”.

- Factory default: kg
- lb

### Change code

You can alter the access code to the supervisor level.

- Enter the current code.
- Enter a new code.

### Program selection

#### Controls

You can select whether the tumble dryer is operated as a “laundromat” machine. Shortcuts are the easiest way to operate the machine. Operating staff are unable to change pre-set programs.

**Tip:** Start by configuring all necessary settings and changes to the tumble dryer before adjusting any of the options below.

**Caution:** When activating any of these options, the supervisor level will no longer be available.

You will no longer be able to access the supervisor level via the display. Please follow the instructions below if you wish to change any other settings.

Opening the supervisor level (laundromat version)

- Switch the tumble dryer on and open the dryer door.
- ① Touch the *Start/Stop* sensor control and hold it down while carrying out steps ②–③.
- ② Close the tumble-dryer door.
- ③ Wait until the *Start/Stop* sensor control, which will now be flashing quickly, lights up constantly ...
- ④ ... and then release the *Start/Stop* sensor control.

## Supervisor level

---

### - Standard

Factory default: All (selected) programs are available.

### - Laundromat, basic

12 programs are available.

Under Favorite programs, you can set which of the 12 programs to select or modify.

### - Laundromat Logo

12 programs are available.

Under Favorite programs, you can set which 12 programs to select/modify.

### - Laundromat Logo ext. time

4 timed programs\* with different temperature levels are time-controlled.

The set value indicates the program runtime and cannot be modified by the user.

\* The maximum program runtime is specified during initial commissioning.

### - Laundromat Logo int. time

4 timed programs\* with different temperature levels are time-controlled via the tumble dryer's electronic.

The set value indicates the maximum program runtime and can be modified by the user.

\* The maximum program runtime is specified during initial commissioning.

### - External prog. selection

A communication module can be used to select the program from an external terminal.

## Program packages

This allows you to specify the scope of the tumble dryer's program. You can select all of the programs or individual programs from the relevant program packages.

The tumble dryer's additional scope of programs can be configured. The programs are listed under "Program overview".

## Favorite programs

After switching on, you can also select a program via: ☆ Favorites.

12 programs can be stored as favorites based on your own priorities and requirements.

These favorite programs will also be made available in the control options

- *Laundromat ext. (12 prog)*

- *Laundromat, basic (4 prog)* (the first 4 of the 12 favorite programs).

You can specify the control option under Controls.

**Tip:** You can assign a different color to each program. In this case, the Program color allocation setting must be set to *On*.

## Changing Favorite programs

■ Select the program you wish to change or replace.

■ Confirm the program or the setting to be changed.

Another menu opens, enabling you to select a new program or change the parameters.

■ Confirm with the Save sensor control.

Your selection is now active.



### Special programs

You can put together 5 special residual-moisture or time-controlled programs and assign your own program names.

First, enter the program name.

- Select the special program you want to change.

The Save as menu opens.

- Use the letters and symbols below the line to enter the name.
- Touch the Save sensor control.

You can now enter the parameters for a Res. moisture program or Timed drying.

The 5 special programs are pre-programmed at the factory. You can change these special programs.

The special programs are added to the program packages. Enter the name and settings of your special program into the “Special programs” table in the “Program overview” chapter.

Res. moisture program:

- Final residual moisture:  
-6% (dry) – 40% (damp)
- Extra drying time:  
0–60 minutes
- Temperature (Process air):  
cold–150°F (65°C)
- Cooling down temperature (Process air):  
105–130°F (40–55°C)
  - Drum rotation main direction:  
45–300 seconds
  - Pause:  
2–5 seconds
  - Drum reversal:  
15–120 seconds
- Anti-crease
  - Drum rotation main direction:  
0–500 seconds
  - Pause:  
100–3,000 seconds
  - Drum reversal:  
0–500 seconds

Timed drying:

- Running time:  
5–180 minutes
- Temperature (Process air):  
cold–150°F (65°C)
- Cooling down temperature (Process air):  
105–130°F (40–55°C)
  - Drum rotation main direction:  
45–300 seconds

## Supervisor level

---

- Pause:  
2–5 seconds
- Drum reversal:  
15–120 seconds
- Anti-crease
  - Drum rotation main direction:  
0–500 seconds
  - Drum reversal:  
0–500 seconds
  - Pause:  
100–300 seconds

### Sort programs

Programs can be moved within the program list and in the Favorites list.

- Factory default: Off
- On

#### Moving programs/favorites

You can move/change the order of the programs (program menu – single option list). You can also move and change the order of the favorites that you edit in the *Supervisor level* under *Favorite programs*.

- Touch the program that you wish to move.
- Press and hold the sensor control until the frame changes.
- Drag the program to the required place.

### Program color allocation

You can assign a specific color to a favorite program. In the list of favorites, each favorite program is given a colored frame, which can be adjusted.

- Factory default: Off
- On

## Process technology

### Anti-crease

At the end of the program, the drum will continue to rotate at intervals if the laundry is not removed immediately.

Changing this setting leads to increased energy consumption.

The setting for Anti-crease (🌀) can either be switched off or a time between 1 and 12 hours can be selected.

Factory default: 2 hours

### Drying levels

Changing this setting leads to increased energy consumption.

You can alter the drying levels for the Cottons, Minimum Iron, and Automatic Plus programs.

Drying levels Cottons, Minimum Iron, and Automatic Plus can be set to one of 7 different levels.

Factory default: Normal

### Additional cooling

If extended cooling is activated, the drum temperature is checked approx. 1 minute before the machine goes into standby mode at the end of the program. If the temperature is above 130°F (55°C), the dryer will carry out cooling until it is below 130°F (55°C).

Changing this setting leads to increased energy consumption.

- Factory default: Off
- On

### Cooling down temperature

The laundry will be cooled down automatically after the end of the program. The automatic cooling phase can be set at a cooler level for all programs. This means that the cooling phase is extended.

Changing this setting leads to increased energy consumption.

The setting can be changed from 104-131°F (40°C–55°C).

Factory default: 131°F (55°C)

### Door opening status

If program interruption in the event of door opening is activated, the tumble dryer remains in the current program when the door is opened and the program continues once the door has been closed and the Start/Stop button has been pressed.

- Factory default: Cancel program
- Interrupt program

## Service

### Clean out the airways

The tumble dryer's electronic calculates the degree to which lint or detergent residues in the lint filters and vent ducting are impairing performance. A message to check the contamination appears. You can decide at what level of lint this reminder should be emitted. If the message appears on the display even though the lint filter is clean, the vent ducting is regarded as borderline. Miele recommends improving the vent ducting. Poor vent ducting will result in longer program runtimes and greater energy consumption.

This reminder, which you can configure, is displayed: Clean out the airways

- Off  
The reminder does not appear. However, if there is a very severe blockage in the ducting, the program will be canceled regardless of this option.
- Heavy  
The reminder only appears when there is a heavy build-up of lint.
- Factory default: normal
- Light  
The reminder appears when there is only a small build-up of lint.

### Clean the filters

The lint filter in the air-supply area must be cleaned on a regular basis. You can set an hourly interval for the reminder.

The selected hourly interval depends on how much lint tends to build up and how often you wish to clean the filter, e.g., for hygiene purposes.

## Supervisor level

---

You can adjust this reminder: Clean the filters

- Time interval of 5 – 55 hours
- Factory default: after 55 hours
- Off

### Service interval

The tumble dryer shows a custom message at a selected interval to prompt you to undertake specific maintenance tasks.

3 different messages can be created: 1/2/3. Each message is created in the language and alphabet of the current supervisor language.

Your message is displayed at the end of the program and can be acknowledged with OK. The same message appears at the end of the next program.

#### Settings

This setting allows you to determine the interval (by hours or date) at which the message appears.

- Factory default: Off
- By time  
You can then select a time interval from 1–9999 hours.
- By date  
You can enter a date.

#### Message text

Enter your message for your planned maintenance work. You can edit one, two, or all three of the 1/2/3 messages.

#### Resetting the display

The message appears until the display is permanently reset. The message then appears again once the next interval is reached.

## External applications

### External exhaust flap

External hardware is connected via the Miele Connector Box.

The time delay between the external exhaust-air flap's activation point and the switch-on time for the drum/fan motor is regulated.

A message appears in the display while the exhaust air flap is open.

- Factory default: off

This option must always be selected if there is no exhaust air flap to activate. This prevents the program from being canceled.

- On (1 second to 5 minutes)

### Additional fan

External hardware is connected via the Miele Connector Box.

The additional fan is switched on by the dryer (via Connector Box) in parallel with the internal fan.

- Off

- On

### Pressure sensor

External hardware is connected via the Miele Connector Box.

When using a shared exhaust air duct, one tumble dryer may have to be switched off or suppressed from the outset if certain pressure levels have built up in the ducting. The external pressure sensor is only checked if the external exhaust air flap and/or the external additional fan is set to "on".

A message appears in the display while the exhaust-air flap is open.

- Off = Not active

- NO contact = Active

Responds to **high potential**

- NC contact = Active

Responds to **low potential**

### Peak load signal

External hardware is connected via the Miele Connector Box.

The peak-load negotiation function enables the tumble dryer to be connected to an energy management system. When a signal is registered, the tumble dryer's heater is switched off for a short period or the machine is prevented from being switched on.

A peak-load signal can be issued via the Connector Box or via the COM module.

- Factory default: No function

- Peak load with 230V

- Peak load with 0V

- KOM module

## Supervisor level

---

### Peak load prevention

- Factory default: Off
- On

### Select KOM module

This tumble dryer is equipped with an integrated WiFi module. However, the tumble dryer can also be equipped with an external module.

- Factory default:
  - Off
- Int. module Domestic  
The internal WiFi module is used.
- Ext. module Professional  
An XKM module is inserted into the module slot.

### Availability of Miele digital products

The ability of Miele digital products depends on the availability of the services in your country.

The different services are not available in all countries.

For information about availability, please visit [www.miele.com](http://www.miele.com).

### WiFi / LAN

Control the networking of your tumble dryer.

Networking of the tumble dryer for use with the digital Professional tools is only possible with the external module. The internal module can only be used by Miele Customer Service.

- Deactivate (visible when the network is activated)  
The network remains set up; the WiFi function is switched off.
- Activate (visible when the network is deactivated)  
The WiFi function is reactivated.
- Connection status (visible when the network is activated)  
The following values are displayed:
  - the quality of WiFi reception
  - the network name
  - the IP address
- Set up again (visible when set up)  
Resets the WiFi login (network) to immediately re-establish a new connection.
- Reset (visible when set up)  
The network is no longer set up. A new connection has to be established in order to use the network again.
  - The WiFi is switched off
  - The WiFi connection will be reset to the factory default

### Remote

External program selection is possible via an external terminal (program may only be started on the machine). However, programs may also be selected and started on the machine.

Factory default: on

### Remote Update

The RemoteUpdate function is used for updating the software in your dryer.

RemoteUpdate is activated by default.

If you do not install a RemoteUpdate, you can continue to use your tumble dryer in the usual way. However, Miele recommends installing RemoteUpdates.

Miele's RemoteUpdate function can only be used if the dryer is connected to a WiFi/LAN network and you have an account in the Miele Professional app. The dryer must be registered in the app.

See the Miele Professional app for terms of use.

If a RemoteUpdate is available for your tumble dryer, it will be displayed automatically when the supervisor level is open.

You can choose to start the RemoteUpdate immediately or wait until later. If you select "Start later", the prompt to run the RemoteUpdate will be displayed again the next time you switch on your tumble dryer.

The RemoteUpdate can take a few minutes.
--

Please note the following information about the RemoteUpdate function:

- You will only receive a message when a RemoteUpdate is available.
- Once a RemoteUpdate has been installed, it cannot be undone.
- Do not switch off the tumble dryer during a RemoteUpdate. Otherwise, the RemoteUpdate will be aborted and will not be installed.

## Supervisor level

---

### Machine parameters

#### Legal Information

#### Open Source Licenses

You can view information here.

#### Copyrights and licenses

For the purpose of operating and controlling the machine, Miele uses proprietary or third-party software that is not covered by open source licensing conditions. This software/these software components are protected by copyright. The copyrights held by Miele and third parties must be respected.

Furthermore, this machine contains software components which are distributed under open source licensing conditions. You can access these open source components along with the corresponding copyright notices, copies of the licensing conditions valid at the time, and any further information. This information can be found under the menu option Settings/Machine parameters/Legal Information/Open Source Licenses. The liability and warranty arrangements for the open source licenses displayed in this location only apply in relation to the respective rights holders.



## Pairing instructions

Follow the steps below to connect the tumble dryer to your network.

### Opening the supervisor level

- Select the Supervisor menu option in the machine display.
- Select the Access via code menu option.
- Enter the 3-digit supervisor code.

### Establishing the network connection via WPS

- Select the Supervisor level menu option from the External applications menu.
- Then select the Select KOM module menu option.
- If you are using an external communication module, select the Ext. module Professional menu option.  
Otherwise, select the Int. module Domestic menu option.
- Select WiFi.
- Select Set up.
- Select the Via WPS connection method.
- Now press the WPS button on your router and confirm with OK in the machine display. A timer starts. The network connection via WPS is being established. The machine is now successfully connected.
- Tap OK to confirm.

### Establishing the network connection via soft AP

- Select the Supervisor level menu option from the External applications menu.
- Then select the Select KOM module menu option.
- If you are using an external communication module, select the Ext. module Professional menu option.  
Otherwise, select the Int. module Domestic menu option.
- Select WiFi.
- Select Set up.
- Select the via Soft AP connection method.
- Confirm by pressing OK and follow the instructions in the external application.

### Establishing the network connection using a LAN cable

- Select the Supervisor level menu option from the External applications menu.
- Then select the Select KOM module menu option.
- If you are using an external communication module, select the Ext. module Professional menu option.  
Otherwise, select the Int. module Domestic menu option.
- Connect the machine to your router/switch using the network cable. The router/switch must be connected to the Internet.

The machine is now successfully connected.

# Networking

---

## Technical data

### System requirements for WiFi

- WiFi 802.11b/g/n
- 2.4 GHz band
- WPA/WPA2 encryption
- DHCP activated
- MulticastDNS/Bonjour/IGMP snooping activated
- Ports 443, 80, 53, and 5353 open
- IP DNS server = IP standard gateway/router
- Mesh/repeater use: same SSID and password as standard gateway/router
- SSID must be permanently visible



### System requirements for LAN

- DHCP activated
- MulticastDNS/Bonjour/IGMP snooping activated
- Ports 443, 80, 53, and 5353 open
- IP DNS server = IP standard gateway/router

### WiFi signal strength – Guide values

The WiFi signal strength is only a rough guide. These details do not provide absolute certainty.

The WiFi signal strength can be read via the MDU or directly on the machine.

WiFi signal strength		Meaning
MDU	 *	
76–100%	3/3**	Reliable operation possible
51–75%	2/3	
26–50%	1/3	Operation possible
1–25%	0/3	Reliable operation not possible
0%		Operation not possible

\* Displayed on the machine

\*\* Number of bars  3/3–0/3

The signal strength can be disturbed by many influences:

- people in the room
- open or closed doors
- moved objects
- varying radio signal sources or interference
- other machines with Bluetooth or WiFi wireless technology

### Cleaning the lint filter

A two-part lint filter in the air guide collects lint released by textiles. Remove and dismantle the lint filter for cleaning.

Check and clean the lint filter at the latest when the *Clean out airways* message appears.

**Tip:** You can also use a vacuum cleaner so that you can remove the lint without touching it.

### Removing the lint filter

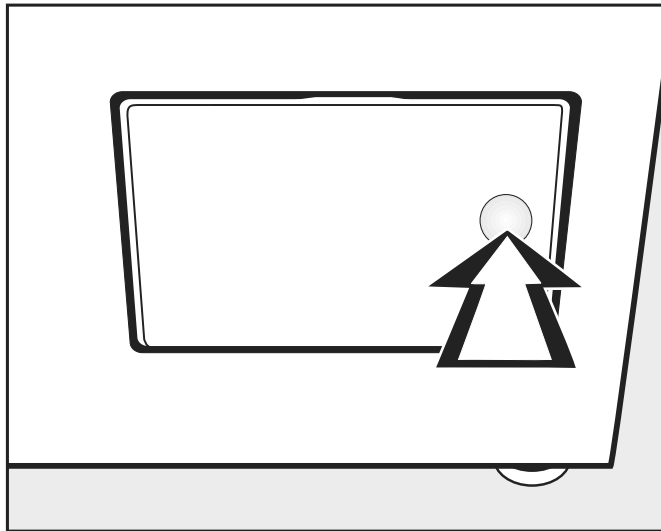

- To open, press against the right side of the lint filter flap.

When pulling out the lint filter, do not rotate the handle (see below) as this will dismantle the filter.

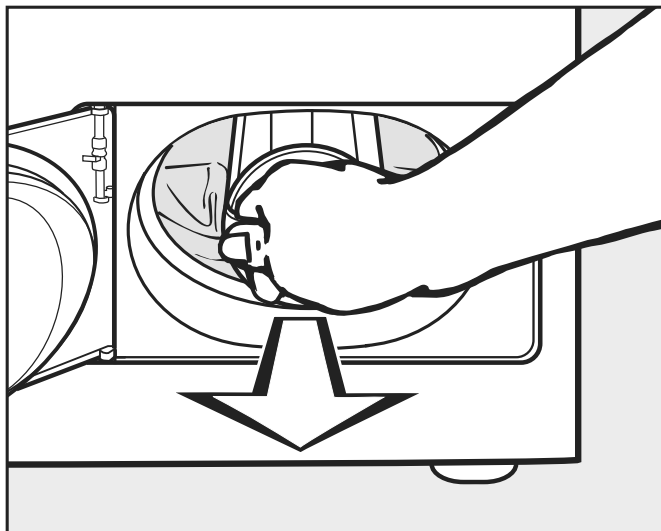

- Use the handle to pull out the lint filter.

## Cleaning and care

### Dismantling the lint filter

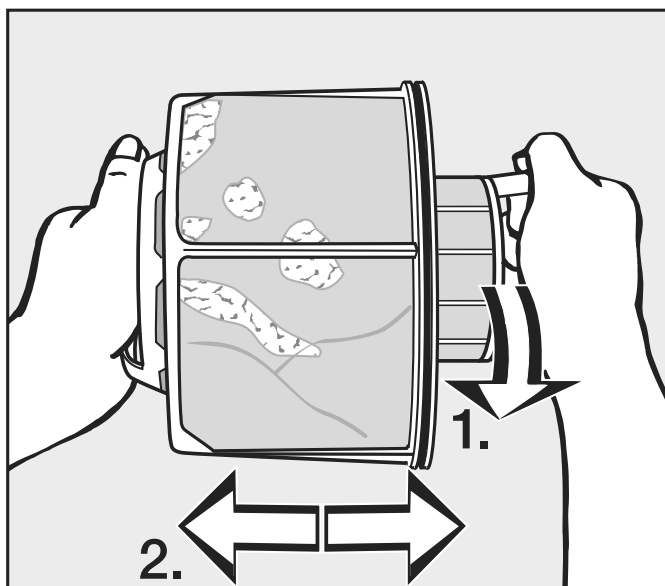

- Hold the lint filter by the handles.
- 1. Rotate the inner part of the lint filter (1).
- 2. Pull the two parts of the lint filter apart (2).

### Cleaning the lint filter parts (dry)

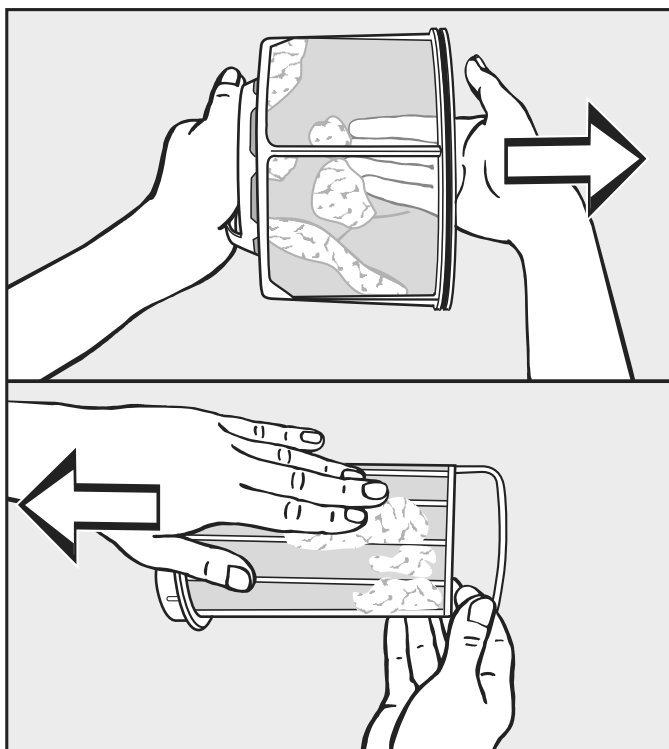

- Shake out the lint and/or pick it off with your fingers.

### Cleaning the lint filter parts (wet)

- Only clean the lint filter parts under warm running water if there is a lot of compacted lint on them.

Dry the lint filter parts before reassembling them. A wet lint filter could cause operational faults while drying.

### Inserting the lint filter

If there is a lot of visible lint, clean the air guide before reinserting the cleaned lint filter. See next page.

- Insert the inner part of the lint filter into the outer part.
- Turn the inner part of the lint filter clockwise slightly until you feel it engage.
- Hold the lint filter by its handle and push it into the lower air guide as far as it will go.

Do not rotate the handle as this will dismantle the filter.

- Close the lint filter flap.

### Cleaning the air guide

Check the air guide from time to time and clean it if there is a lot of lint present.

### Rapid cleaning

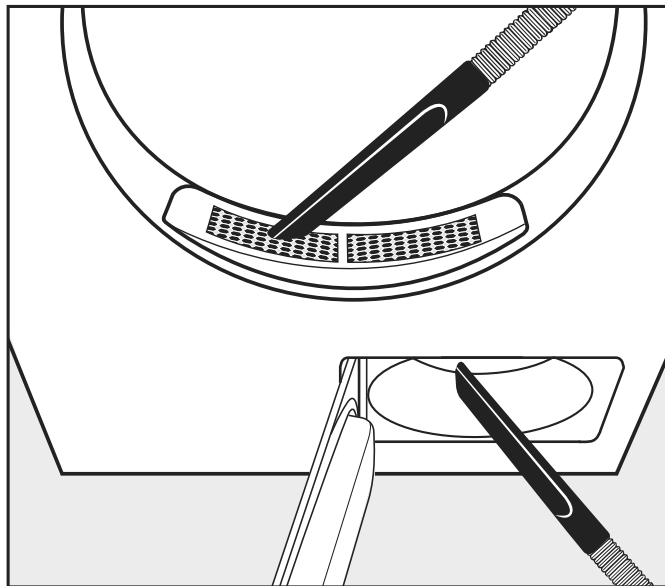

- Use a vacuum cleaner to remove lint:
  - from the cover in the door area (top)
  - from the air guide in front of the fan impeller (bottom) after first removing and cleaning the lint filter

### Additional cleaning

Cleaning the drum and the outside of the casing

⚠ Risk of death due to electric shock.

The tumble dryer must be completely disconnected from the electricity supply before performing cleaning or maintenance work. Before starting cleaning or maintenance work, always switch off the tumble dryer at the on-site power switch. Do not use a pressure washer or water jet to clean the tumble dryer.

## Cleaning and care

⚠ Risk of damage due to solvent-based cleaning agents and abrasive cleaners.

Solvent based cleaning agents, abrasive cleaners, glass cleaners, or all-purpose cleaners can cause damage to plastic surfaces and other parts.

Clean the tumble dryer with a slightly damp cloth and a mild non-abrasive cleaning agent or soapy water.

- Clean the seal around the inside of the door with a damp cloth.
- The tumble dryer drum must be wiped clean with a soft, damp cloth after drying items that have been starched.
- Dry all the parts with a soft cloth.
- The stainless steel parts (e.g., drum) can be cleaned with a suitable stainless steel cleaner if you wish.

The air intake vent is located on the rear of the tumble dryer.

This vent must never be covered or blocked with objects.

Keep the area around the tumble dryer – in particular the air intake – clear of lint.

### - Fan impeller

The fan impeller behind the lint filter flap may be soiled with detergent residue and lint.

Check the fan impeller from time to time and clean it if it is heavily soiled.

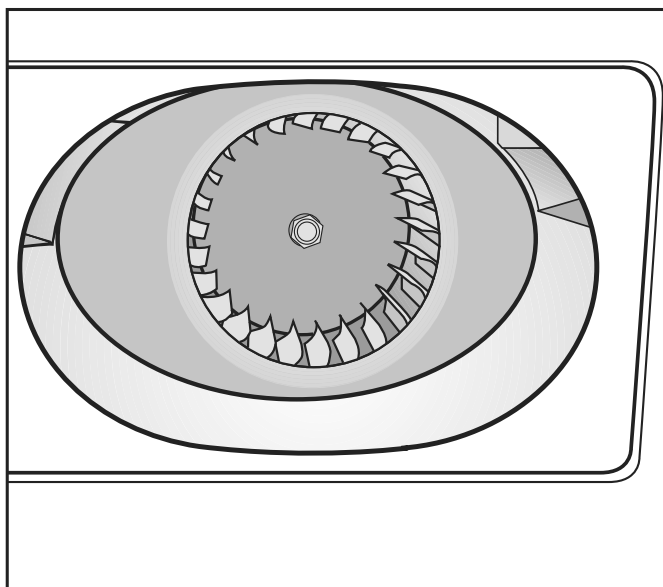

- Using a damp cleaning cloth, carefully remove the coating on the fan impeller.
- Also clean the area in front of the fan impeller.
- Use a vacuum cleaner to remove lint.
- Remove any lint from the inside of the open lint filter flap and the sealing element. Be careful not to damage the sealing element.

### - Cover in door area

Only remove the cover in the door area in the event of a major blockage.

### Removing the cover

- Look inside the drum.

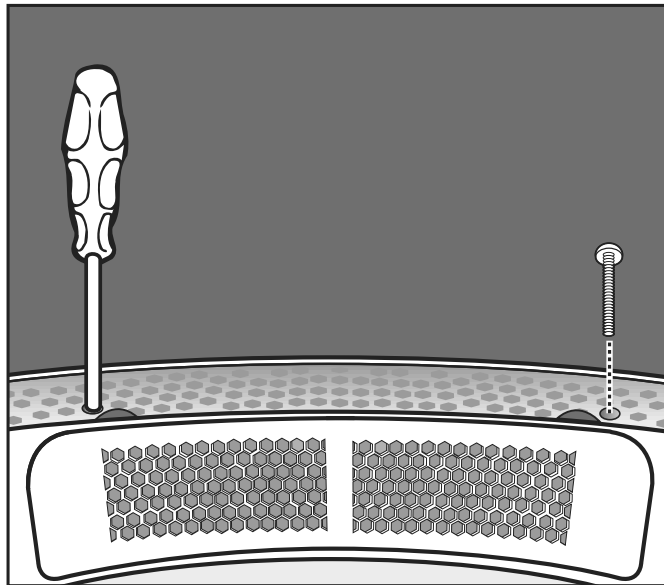

- Underneath the cover on the left and right, unscrew the Torx screws through the round holes.

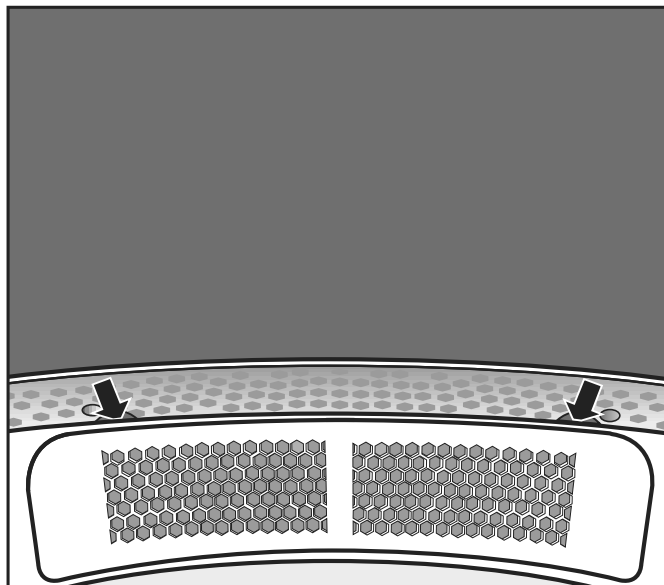

- Reach under the edge of the cover (see arrows) and lift off the cover.
- Clean the air guide underneath the cover with a vacuum cleaner.
- Clean the cover.
- Clean the air guide in front of the fan impeller (open the lint filter flap).

### Reassembly

- Carefully position the cover on the left or right side of the opening.
- Press down the cover until it engages on the opposite side.

### Securing the cover

- Look inside the drum.
- Underneath the cover on the left and right, screw in the Torx screws through the round holes.

## Cleaning and care

---

### **Cleaning set**

The Miele Cleaning Set is available separately for effective and gentle cleaning of the tumble dryer.

The cleaning set consists of:

- microfiber cloth
- cleaning brush
- dust brush
- crevice nozzle



### Problem solving guide

Message	Possible cause and solution
<b>The display remains dark.</b>	There is no power to the tumble dryer. <ul style="list-style-type: none"> <li>■ Check the electrical plug, main switch, and fuses (on site).</li> </ul>
Problem	Possible cause and solution
<b>The efficiency of the tumble dryer is decreasing.</b>	The lint filter in the tumble dryer is dirty. <ul style="list-style-type: none"> <li>■ Check the lint filter in the tumble dryer for contamination and clean it if necessary.</li> </ul>
	Insufficient ventilation <ul style="list-style-type: none"> <li>■ Make sure that the air-intake vent and the tumble-dryer ducting are not covered or blocked by objects.</li> </ul>
	Room temperature too high (>113°F/45°C) <ul style="list-style-type: none"> <li>■ Ensure adequate ventilation of the installation site.</li> <li>■ If necessary, connect the tumble dryer to external fresh-air and exhaust-air ducting.</li> </ul>
<b>Feather-filled pillows smell after drying.</b>	Feathers tend to develop a build-up of their own smell or smells from other sources when they are heated. <ul style="list-style-type: none"> <li>■ Smells can be reduced through natural ventilation after drying.</li> </ul>
<b>Items made of synthetic fibers are charged with static electricity after drying.</b>	Synthetic fibers tend to attract static charge. <ul style="list-style-type: none"> <li>■ Static charge can be reduced by adding a fabric softener to the final rinse in the washing program.</li> </ul>
<b>Lint is caused by tumble drying.</b>	Lint is principally the result of friction when garments are being worn and to some extent when they are being washed. Machine drying hardly causes any lint to form. Lint is collected by the lint filters and fine filter and can be easily removed. <ul style="list-style-type: none"> <li>■ See “Cleaning and care”.</li> </ul>
<b>The drying process goes on too long or even switches off.</b>	In some circumstances, you may be asked to clean the air channels/air guide. <ul style="list-style-type: none"> <li>■ Please check all the possible causes described below.</li> </ul>
	The lint filter is clogged with lint. <ul style="list-style-type: none"> <li>■ Remove the lint.</li> </ul>
	The air guide area is clogged with hair and lint, for example. <ul style="list-style-type: none"> <li>■ Cleaning the air guide area.</li> <li>■ You can remove the cover in the loading area to clean the air guide area underneath.</li> </ul>
	The vent ducting or its openings are clogged with hair and lint, for example. <ul style="list-style-type: none"> <li>■ Check and clean all components in the vent ducting (e.g., wall pipe, external grille, bends, elbows, etc.).</li> </ul>
	The flow of air is insufficient (e.g., because it is installed in a small room).

## Frequently asked questions

Problem	Possible cause and solution
	<ul style="list-style-type: none"> <li>■ When drying, open a door or window to ensure sufficient ventilation.</li> </ul> <p>The laundry has not been spun sufficiently.</p> <ul style="list-style-type: none"> <li>■ In future, make sure that your laundry is thoroughly spun at the appropriate spin speed in the washing machine.</li> </ul> <p>The tumble dryer has been overloaded.</p> <ul style="list-style-type: none"> <li>■ Do not exceed the maximum load size for the drying program selected.</li> </ul> <p>Metallic components, e.g., zippers, have prevented the tumble dryer from registering the correct laundry moisture level.</p> <ul style="list-style-type: none"> <li>■ Open any zippers next time.</li> <li>■ If the problem occurs again, dry garments with long zippers using the hot air drying program.</li> </ul>
<p><b>Condensation is forming in the drum.</b></p>	<p>The tumble dryer is installed on a shared exhaust air duct.</p> <ul style="list-style-type: none"> <li>■ The tumble dryer must always be installed with a non-return flap when using a shared duct.</li> <li>■ Check the non-return flap for possible defects on a regular basis and replace the flap if necessary.</li> </ul>

### **Contact in case of fault**

In the event of a fault which you cannot remedy yourself, please contact your Miele dealer or Miele Technical Service.

Contact information for Miele Technical Service can be found at the end of this document.

Please quote the model and serial number of your appliance when contacting Miele. Both pieces of information can be found on the data plate.

### **Optional accessories**

Optional accessories for this tumble dryer are available from your Miele dealer or from Miele Customer Service.

## Installation requirements

 Risk of injury or damage to property due to improper installation.

Incorrect installation of the tumble dryer can lead to personal injury or damage to property.

It is recommended that installation and commissioning be accomplished by Miele Service or an authorized dealer.

- ▶ The tumble dryer must be installed in accordance with all relevant regulations and standards. Observe all local codes.
- ▶ The dryer must only be operated in a room that has sufficient ventilation and which is frost-free.
- ▶ The tumble dryer must not be installed behind a closeable door or a sliding door. The maximum opening angle of the tumble dryer door must not be limited by objects or doors. It must be possible to fully open the tumble dryer door at any time.

## General operating conditions

This dryer is intended only for use in a commercial environment and must only be operated indoors.

Do not install the tumble dryer in a room where there is a risk of frost. Depending on the nature of the installation site, sound emissions and vibration may occur.

**Tip:** Have the installation site inspected and seek the advice of a professional in instances where increased noise may cause a nuisance.

## Installation locations

### Front view

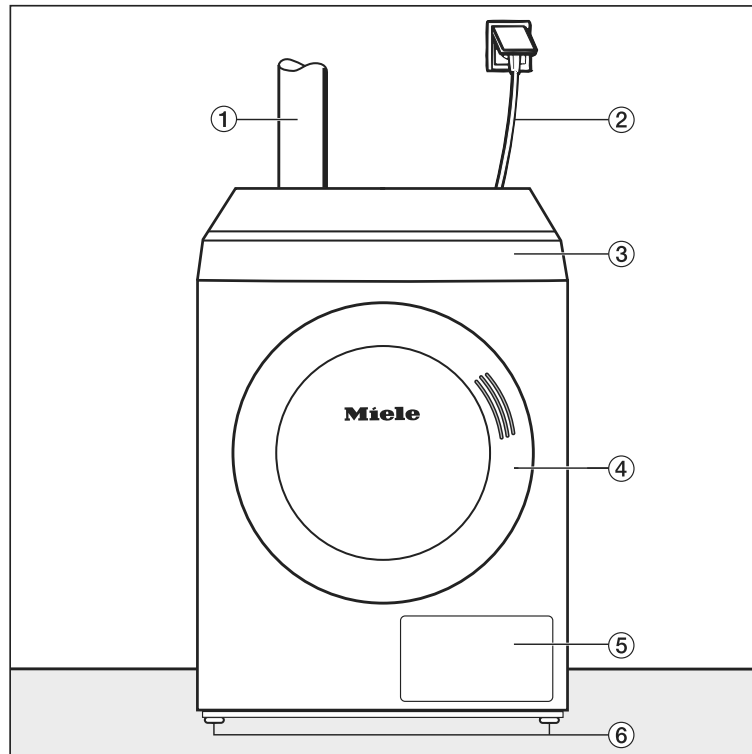

- |                                    |                                     |
|------------------------------------|-------------------------------------|
| ① Vent ducting                     | ④ Door                              |
| ② Electrical connection cable      | ⑤ Lint filter flap                  |
| ③ Control panel with touch display | ⑥ Four height-adjustable screw feet |

### Side view

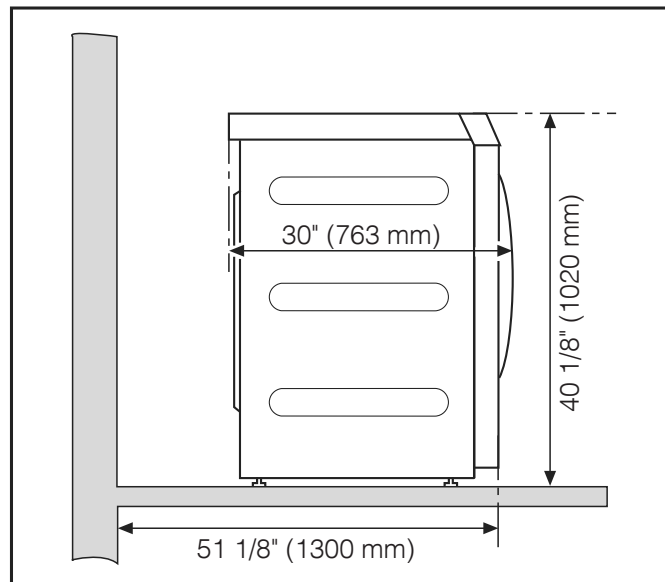

# Installation

## Rear view

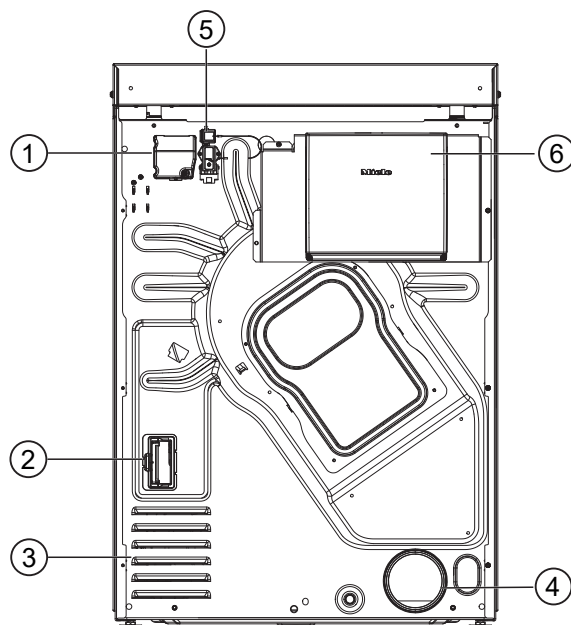

- ① Electrical connection
- ② Communication module slot
- ③ Intake vents for drying air
- ④ Exhaust duct Ø 4" (100 mm)
- ⑤ Connection for communication box
- ⑥ Communication box (optional)  
For setting up a connection with external systems

## View from above

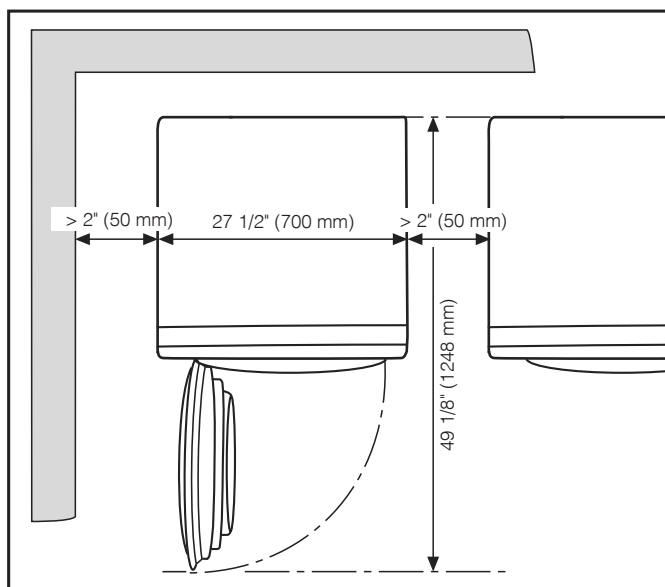

## Installation on a base

Various Miele bases are available as optional accessories.

⚠ Risk of injury and damage due to missing tumble dryer fastenings.

When installing on a base, an unsecured tumble dryer can slip and fall off the base.

If the tumble dryer is installed on a base, it must be secured.  
The base must be secured to the floor.

## Installation

### Transporting the tumble dryer

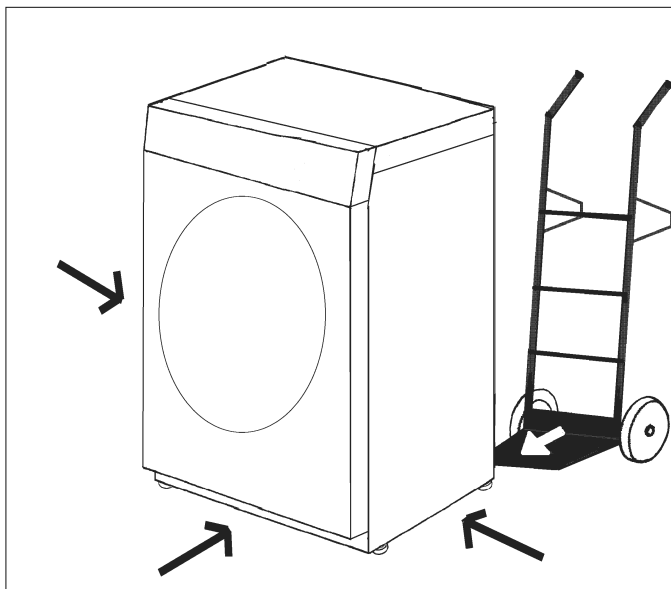

Transport the tumble dryer to its installation site using a suitable transport base (e.g., hand truck).

⚠ Risk of injury caused by the tumble dryer tipping over.

When transporting the tumble dryer, there is the risk of the tumble dryer tipping over.

Ensure that the tumble dryer is stable during transportation.

### Leveling the machine



Ensure that no closeable door, sliding door, or oppositely hinged door is installed that could hinder opening of the tumble dryer door in any way.

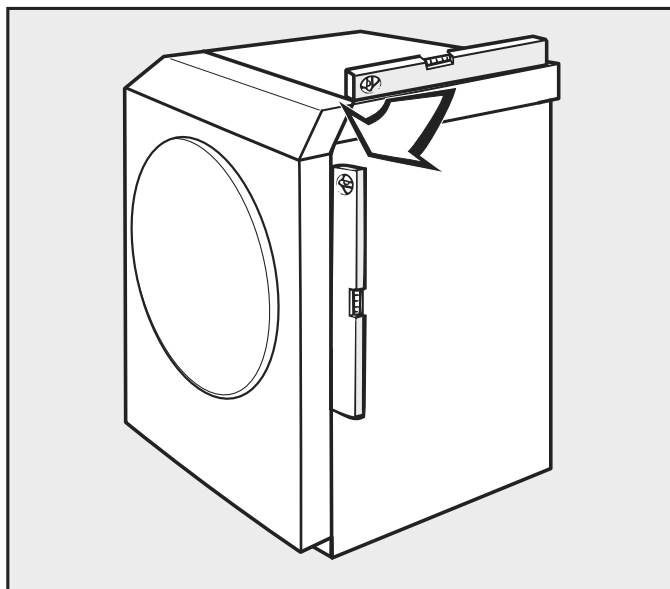

The tumble dryer must stand perfectly level on all four feet to ensure safe and proper operation.

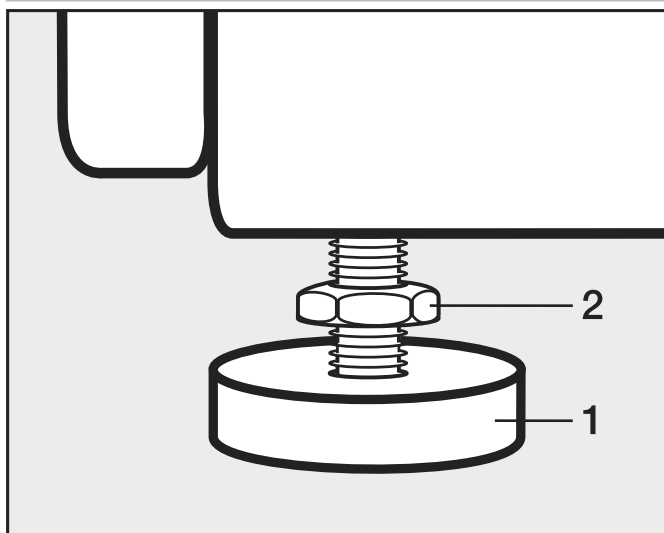

- Undo the screws (2).
- The screw feet (1) can be adjusted to compensate for any unevenness in the floor.
- Tighten the screws (2) against the casing.

### Electrical connection

The electrical connection must be established by a qualified electrician.

- ▶ The machine must only be connected to an electrical supply provided in accordance with local codes and standards. Please also observe the regulations set out by your insurance provider and energy supplier, accident prevention regulations, as well as recognized codes of practice.
- ▶ Reliable and safe operation of this tumble dryer is only ensured if it has been connected to the electricity supply.



The required supply voltage, power rating, and fuse rating can be found on the data plate on the tumble dryer. Ensure that the supply voltage matches the voltage quoted on the data plate before connecting the machine to the electricity supply.

Connection to a supply voltage other than the one quoted on the data plate can damage the tumble dryer if the voltage is too high.

► If more than one voltage is specified on the data plate, the tumble dryer can be converted for connection to the relevant input voltage. This conversion must be performed by Miele Customer Service or by an authorized dealer. During the conversion, the wiring instructions given on the wiring diagram must be followed.

The tumble dryer can either be hard-wired or connected using a plug-and-socket connection in accordance with IEC 60309-1. For a hard-wired connection, an all-pole disconnect switch must be available at the installation site.

A disconnect switch is a switch which ensures a contact opening of more than 1/8" (3 mm). These include circuit breakers, breakers, and contactors (IEC/EN 60947).

If the power supply cannot be permanently disconnected, the disconnect switch (including plug and socket) must be safeguarded against being switched on either unintentionally or without authorization.

**Tip:** We recommend connecting the tumble dryer to the power supply via a plug and socket so that it is easier to conduct electrical safety checks (e.g., during maintenance or repair work).

► The tumble dryer must not be connected to devices such as timers which would switch it off automatically.

► If it is necessary to install a residual current device (RCD) in accordance with local regulations, a residual current device type B (sensitive to universal current) must be used.

► If local and national installation specifications require equipotential bonding, good galvanic contact must be guaranteed. Equipotential bonding must have a ground current rating > 10 mA.

## Supply air and exhaust air management

The tumble dryer may only be operated when the ducting has been connected properly and the room is sufficiently ventilated.

## Ventilation

The air required for drying is taken from the room where the dryer is installed.

Ensure sufficient room ventilation, e.g., by means of ventilation openings that cannot be closed in the exterior wall.

- It must not be possible to seal off ventilation openings.
- The room ventilation is only working properly if no low pressure occurs. Avoid low pressure, e.g., by means of ventilation openings in the exterior wall.
- For each tumble dryer, there must be a cross section of 36 sq.in. (237 cm<sup>2</sup>) per ventilation opening.

## Installation

---

The tumble dryer draws in air at the back. Therefore, there must be a sufficiently large gap between the back of the machine and the wall.

This would otherwise hinder a sufficient flow of air as well as the operational performance of the tumble dryer.

Observe the necessary spacing between the machine and the wall. Do not reduce the gap between the bottom of the tumble dryer and the floor (e.g., toe-kicks, deep pile carpet).

### Exhaust air management

The tumble dryer must only be operated if the humid exhaust air generated during drying is conveyed outside through installed vent ducting.

The exhaust air should not be vented into a wall, a ceiling, or a concealed space of building.

Exceptions regarding the design of the exhaust air management system must be designed in accordance with the applicable local building regulations. Seek approval from the relevant building inspector.

- While installing the ducting, keep the tumble dryer disconnected from the power supply.
- Make sure that the plug connections are fully sealed.
- The duct is not to be assembled with screws or other fastening means that extend into the duct and catch lint
- Only use heat-resistant materials with a temperature resistance of at least 175°F (80°C).
- Only use rigid or flexible metal duct.
- Condensation will form in the exhaust air management system. A condensate drain must therefore be placed at the lowest point in the system.

The opening of the vent ducting (e.g., a wall pipe) must be arranged in such a way that the humid exhaust air:

- does not flow back into the room where the tumble dryer is installed
- does not cause damage or unacceptable disturbance

The air required for drying is taken from the room where the dryer is installed. You must therefore ensure that the room is sufficiently ventilated. Otherwise, there is a risk of suffocation due to exhaust gases being sucked back from other technical systems or fuel-burning installations, and the drying time will be much longer.

The length of the required ductwork and the number and shape of the elbows are determined by the structural conditions on-site. In order to maximize the airflow efficiency, the pipeline should be as short as possible and contain few or minimal elbows.

⚠ The exhaust ducting must not be made from flammable materials.

Otherwise there is a risk of fire.

Use only non-flammable materials for the exhaust ducting. All local regulations for metallic ducting must be observed. Plastic must not be used for ventilation.

In upward exhaust ducting systems, a condensate drain must be fitted to the bottom. The condensate must be drained via a water collection tray or a floor drain positioned in an appropriate location.

If air is being directed from multiple appliances into a combined line (exceptional circumstances), a non-return device (non-return flap) must be installed in each separate line to prevent backflow.

To make subsequent cleaning of the pipes easier, cleaning flaps should be fitted to elbows wherever possible.

The on-site exhaust ducting and venting to the outdoors must be regularly checked for lint deposits and cleaned if necessary.

When connected to the vent ducting through the exhaust duct of a machine, particular care must be taken to make sure the connection is secure and air-tight.

With complex ducting with many bends and additional components, or when several different machines are connected to a shared duct, it is recommended that a detailed pipework calculation is carried out by a qualified specialist.

The vent ducting must not be channeled into a chimney or flue already in use for any gas-, coal-, or oil-burning installation. The warm and moist exhaust air is to be conducted outside or to a suitable venting duct over the shortest path possible.

The vent ducting must be laid so that air flow is not hindered. To achieve this, use as few bends as possible along with short pipelines and well-made connections and transitions checked for air-tightness. No filters or grilles may be fitted in the vent ducting.

The end of the vent ducting leading out into the open should be protected against the elements, e.g., with a downward-facing 90° bend.

⚠ During tumble dryer operation, the room must be adequately ventilated.

The following should be avoided:

- long vent ducting
- too many tight bends or elbows

This will help to stop a reduced dryer performance and excessive time and energy requirements.

Use:

- for the vent ducting: exhaust air hose\* or a plastic waste water pipe (e.g., HT piping systems) with a minimum diameter of 4" (100 mm)
- for the extraction ducting outside: wall pipe\* or window connection\*

\*optional accessories

**Calculating the total ducting length**

The friction of the vent ducting with its bends and various components provides resistance to the flow of exhaust air. This friction resistance is expressed as a relative pipe length. The **relative pipe length**

# Installation

indicates how much greater the resistance of a bend is, for example, when compared to 1 meter of a straight plastic waste water pipe (Table I).

Adding together the relative pipe lengths for all of the components gives the **total ducting length**. The total ducting length expresses the resistance of the entire exhaust air system.

As a larger **duct diameter** has a lower flow resistance, a longer duct requires a greater duct diameter (Table II).

## Procedure

1. Measure the length needed for the straight sections of vent ducting. Multiply this value by the corresponding relative pipe length from **Table I**.
2. Calculate the number of bends and components needed. Use **Table I** to help you add together their relative pipe lengths.
3. Add together all of the relative pipe lengths calculated above to calculate the total ducting length.
4. Refer to **Table II** for the pipe diameter needed for the total ducting length.

<b>Table I</b>	
<b>Components</b>	<b>Relative pipe length</b>
<b>Exhaust air hose (flexible aluminum)* / pipe (temperature resistance min. 175°F (80°C))</b>	
– 3' 3" (1 m) laid straight or 3' 3" (1 m) straight pipe	3' 3" (1.0 m)
– 45° bend (radius of bend = 10" (0.25 m))	
– 90° bend (radius of bend = 10" (0.25 m))	2' (0.6 m)
	2' 7 1/2" (0.8 m)
<b>The use of a wall pipe or window connection is regarded as an exception to the design principles of the exhaust air management system. This must be carried out in accordance with the applicable local building regulations. Seek approval from the relevant building inspector where necessary.</b>	
<b>Wall pipe* or window connection*</b>	
– with inserted grate	12' 5 5/8" (3.8 m)
– with non-return flap (swinging flap)	4' 11" (1.5 m)
<b>Non-return flap*</b>	46' 11" (14.3 m)
* optional accessories	

<b>Table II</b>	
<b>Maximum permissible total ducting length</b>	<b>Required diameter</b>
65' (20 m)	4" (100 mm)
130' (40 m)	5" (125 mm)
262' (80 m)	6" (150 mm)

## Sample calculation

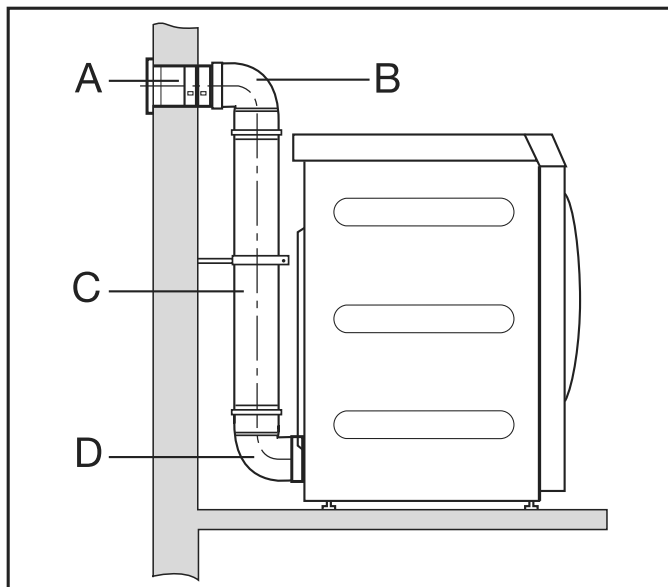

<b>A</b>	<b>Wall pipe, with inserted grate</b> = 1 x 12' 5 5/8" (3.8 m) relative pipe length	= 12' 5 5/8" (3.8 m)
<b>B/D</b>	<b>2 bends, 90°</b> = 2 x 2' 7 1/2" (0.8 m) relative pipe length	= 5' 3" (1.6 m)
<b>C</b>	<b>1' 7 11/16" (0.5 m) pipe</b> = 0.5 x 3' 3" (1 m) relative pipe length	= 1' 7" (0.5 m)
Total ducting length		= 19' 4" (5.9 m)

**Result:** The total ducting length is less than 65' 7 3/8" (20 m) (as per Table II). A pipe diameter of 4" (100 mm) will therefore suffice.

## Exhaust duct dimensions

### View from above

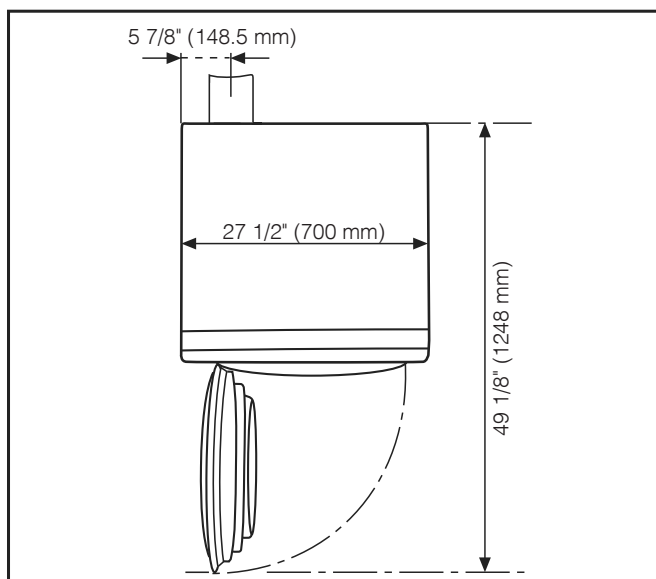

### Rear view

# Installation

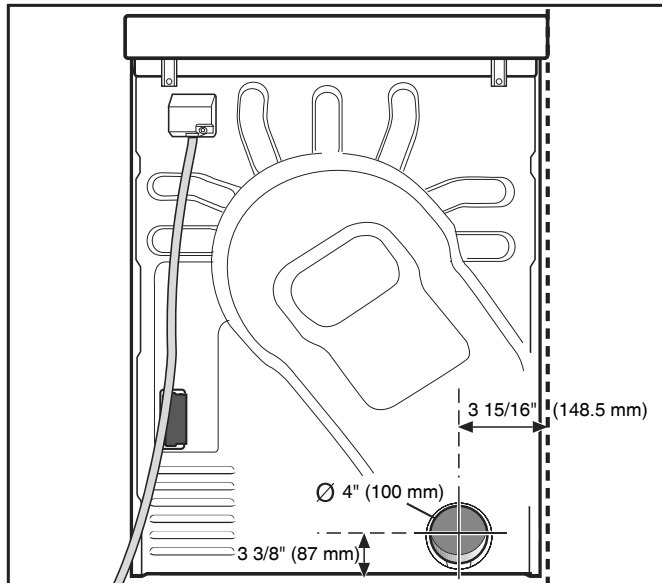

## Exhaust air management with plug-in pipes

You will need:

- the connector (supplied)
- pipes and connecting pieces from a suitable retailer

Only use heat-resistant materials with a temperature resistance of at least 175°F (80°C).

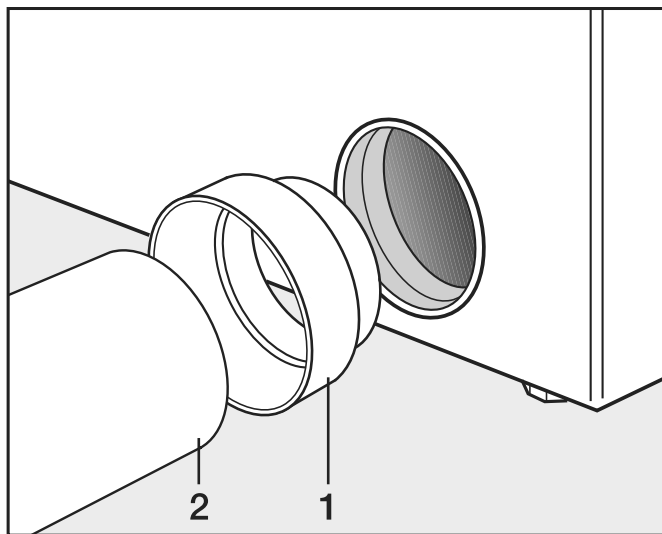

- Install the connector (1) and the pipe (2).

⚠ Wrap heat-resistant metallic tape around the plug connections.

## Exhaust air management with flexible aluminum hose

You will need:

- the adapter (supplied)
- flexible aluminum exhaust air hose

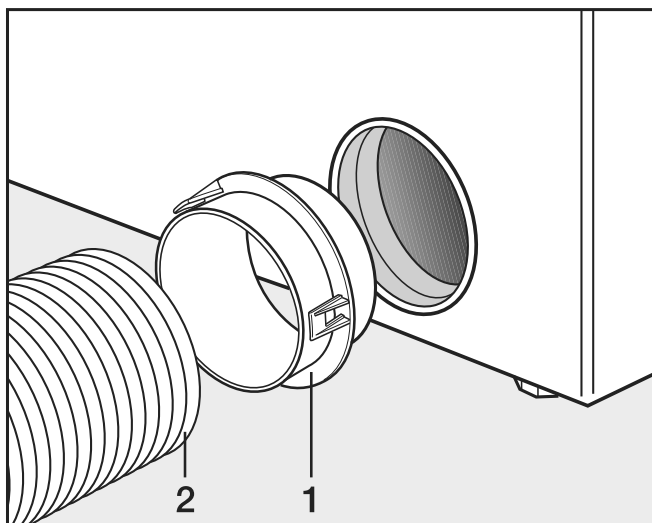

- Install the adapter (1) and the flexible aluminum exhaust air hose (2).



Wrap heat-resistant metallic tape around plug connections.

## Shared exhaust air duct

A shared exhaust air duct is only permitted in exceptional cases. The shared exhaust air duct must be approved by the relevant building inspector.



A non-return flap must be installed for each tumble dryer. Otherwise, the tumble dryers may be damaged by a backflow of condensation and their electrical safety could be affected.

If 3–5 tumble dryers are installed on one shared exhaust air duct, the pipe diameter **D** must be increased.

Number of tumble dryers	Factor for increasing the pipe diameters from Table II
3	1.25
4–5	1.5

## Installation

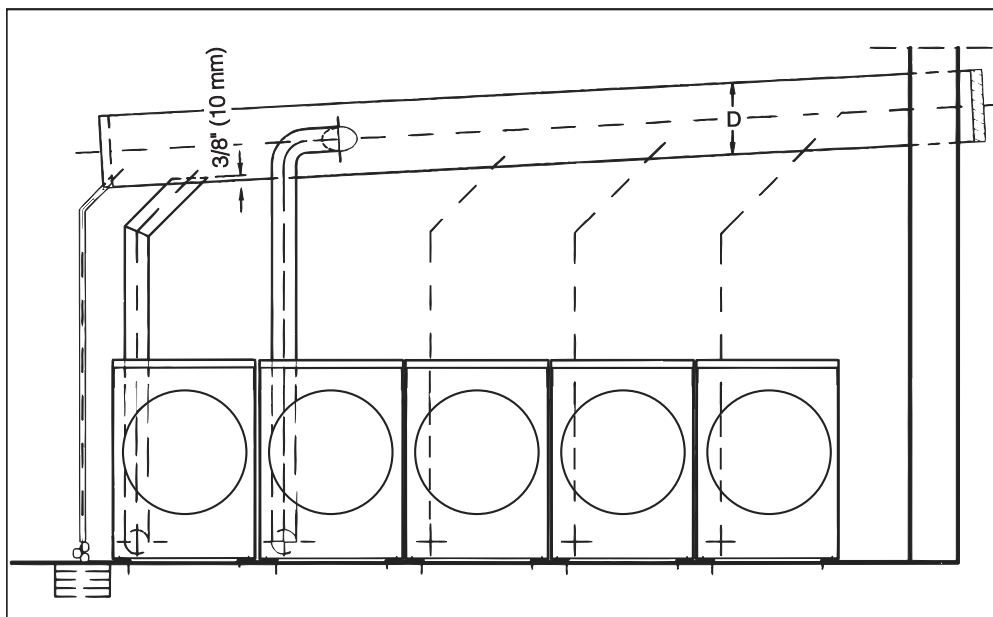

**⚠ Risk of electric shock and injury due to using the tumble dryer without the complete casing.**  
If the casing is dismantled, it is possible to come into contact with live or rotating machine parts.  
Once the tumble dryer has been installed, completely replace all the casing parts that were removed.



► Only use genuine Miele spare parts and accessories with this machine. Using parts or accessories from other manufacturers will invalidate the warranty, and Miele cannot accept liability.

### Cleaning set

The Miele Cleaning Set is available separately for effective and gentle cleaning of the tumble dryer.

The cleaning set consists of:

- microfiber cloth
- cleaning brush
- dust brush
- crevice nozzle

### Communication box

The optional communication box allows external hardware from Miele and other suppliers to be connected to the Miele Professional machine. External hardware includes e.g., peak-load systems, pressure sensors, or an external vent flap.

The communication box is supplied with voltage by the Miele Professional machine.

The separately available set consists of the communication box and fasteners for installation on the machine or on the wall.

### XKM 3200 WL PLT

The optional Miele communication module can be used to establish a data connection between a Miele Professional machine and a data processor in accordance with the Ethernet or WiFi standard.

This communication module fits into the communication slot which is a standard feature on all machines. The communication module offers the option of intelligent app-based communication with external systems. In addition, it can display detailed machine and program status information.

This module forms the basis for wired communication with Miele MOVE.

It is not possible to integrate the machine into the “Miele@home” app for domestic installations.

The communication module is intended exclusively for commercial use and is supplied with voltage directly via the Miele Professional machine. No additional power connection is required. The Ethernet interface provided via the communication module complies with SELV (safety extra low voltage) requirements in accordance with EN 60950. Connected external machines must also comply with SELV.

### Data protection and data security

When you activate the networking function and connect your machine to the Internet, your machine sends the following data to the Miele Cloud:

- machine serial number
- machine model and technical features
- machine status
- information about the software status of your machine

## Optional accessories

---

Initially, this data cannot be assigned to a specific user and is not saved permanently. Data cannot be saved permanently or assigned to a specific user until after you have linked your machine to a user. Data transmission and processing are governed by Miele's strict security standards.

### **Factory default settings for network configuration**

You can reset all of the settings on the communication module or your integrated WiFi module to the factory default settings. The network configuration should be reset whenever a machine is being disposed of or sold, or if a used machine is being put into operation. This is the only way to ensure that all personal data has been removed and the previous owner will no longer be able to access the machine.

### Copyrights and licenses

For the purpose of operating and controlling the communication module, Miele uses proprietary or third-party software that is not covered by open source licensing terms. This software/these software components are protected by copyright. The copyrights held by Miele and third parties must be respected.

This communication module contains software components which are distributed under open source license conditions. The open source components contained in the machine along with the corresponding copyright notices, copies of the licensing terms valid at the time, and any additional information can be accessed locally by IP via a web browser (<https://<IP address>/Licenses>). The liability and warranty arrangements for the open source licenses displayed in this location only apply in relation to the respective rights holders.

### Original spare parts and accessories

Miele machines are highly durable due to their excellent quality. If, however, repair work does become necessary, key functional spare parts will remain available for up to 15 years following discontinuation (this does not apply to digital products or products for process documentation).

Contact Miele Customer Service if you need spare parts and accessories or would like personalized advice.

 Danger due to improperly performed service and repair work.

Service and repair work should only be carried out by a suitably qualified electrician in accordance with all appropriate safety requirements.

Servicing, modification, testing, and maintenance of electrical machines must be carried out in accordance with all appropriate legal requirements, accident prevention regulations, and valid standards.

All live wires must be safely disconnected before any service or repair work is commenced on the machine.

## Technical data

Height	40 3/16" (1,020 mm)
Width	27 9/16" (700 mm)
Depth	30 1/16" (763 mm)
Depth with door open	49 1/8" (1,248 mm)
Weight	159 lb (72 kg)
Drum volume	180 l
Maximum load size (dry laundry)	22 lb (10 kg)
Power cord length	63" (1,600 mm)
Connection voltage	See data plate
Rated load	See data plate
Fuse rating	See data plate
Wattage of incandescent bulb	See data plate
Test certificates awarded	See data plate
Max. floor load in operating status	853 N
Product safety standards	IEC 60335-1; UL 1240; IEC 60335-2-11
Emission sound pressure level	50 dB re 20 µPa
Permitted ambient temperature	36–104 °F (2–40 °C)
Frequency range	2.4000–2.4835 GHz
Maximum transmission power	< 100 mW

ANY CHANGES OR MODIFICATIONS NOT EXPRESSLY APPROVED BY THE PARTY RESPONSIBLE FOR COMPLIANCE COULD VOID THE USER'S AUTHORITY TO OPERATE THE EQUIPMENT.

THIS DEVICE COMPLIES WITH PART 15 OF THE FCC RULES AND CONTAINS LICENSE-EXEMPT TRANSMITTER(S)/RECEIVER(S) THAT COMPLY WITH INNOVATION, SCIENCE AND ECONOMIC DEVELOPMENT CANADA'S LICENCE-EXEMPT RSS STANDARD(S). OPERATION IS SUBJECT TO THE FOLLOWING TWO CONDITIONS: (1) THIS DEVICE MAY NOT CAUSE HARMFUL INTERFERENCE, AND (2) THIS DEVICE MUST ACCEPT ANY INTERFERENCE RECEIVED, INCLUDING INTERFERENCE THAT MAY CAUSE UNDESIRE OPERATION.

Contains FCC ID: 2ACUWEK047

Contains IC: 5669C-EK047

RADIATION EXPOSURE STATEMENT: THIS EQUIPMENT COMPLIES WITH FCC AND WITH ICSED RADIATION EXPOSURE LIMITS SET FORTH FOR AN UNCONTROLLED ENVIRONMENT. THIS EQUIPMENT SHOULD BE INSTALLED AND OPERATED WITH A MINIMUM DISTANCE OF 20CM BETWEEN THE RADIATOR AND YOUR BODY. THIS DEVICE AND ITS ANTENNA(S) MUST NOT BE CO-LOCATED OR OPERATION IN CONJUNCTION WITH ANY OTHER ANTENNA OR TRANSMITTER.



Please have the model and serial number  
of your machine available when  
contacting Technical Service.

---

## U.S.A.

Miele, Inc.

### National Headquarters

9 Independence Way  
Princeton, NJ 08540  
Phone: 800-991-9380  
[www.mieleusa.com/professional](http://www.mieleusa.com/professional)  
[prosales@mieleusa.com](mailto:prosales@mieleusa.com)

### Technical Service & Support

Phone: 800-991-9380  
[proservice@mieleusa.com](mailto:proservice@mieleusa.com)

## Canada

Importer  
Miele Limited

### Professional Division

161 Four Valley Drive  
Vaughan, ON L4K 4V8  
Phone: 1-888-325-3957  
[www.mieleprofessional.ca](http://www.mieleprofessional.ca)  
[professional@miele.ca](mailto:professional@miele.ca)

### Miele Professional Technical Service

Phone: 1-888-325-3957  
[serviceprofessional@miele.ca](mailto:serviceprofessional@miele.ca)



Manufacturer: Miele & Cie. KG  
Carl-Miele-Straße 29, 33332 Gütersloh, Germany