



Operating and installation instructions Oven



It is **essential** to read these operating and installation instructions before installing and using the appliance. This prevents both personal injury and damage to the appliance.

Contents

Warning and Safety instructions	5
Caring for the environment	12
Oven overview	13
Oven controls	14
Function selector	15
Temperature selector	15
Clock/Timer	15
Display	15
Sensor controls	15
Features	16
Data plate	16
Items supplied	16
Standard and optional accessories	16
Safety features	20
PerfectClean treated surfaces	20
Before using for the first time	21
Before using for the first time	21
Setting the time of day for the first time	21
Heating up the oven for the first time	22
Energy saving tips	23
Operation	24
Basic operation	24
Cooling fan	24
Pre-heating the oven	24
Clock/Timer	25
Display	25
Symbols in the display	25
Sensor controls	25
How to set the time or a duration	26
Displaying times/durations	26
When the time/duration has elapsed	26
Using the minute minder 	27
Setting the minute minder	27
Changing the time set for the minute minder	28
Cancelling the minute minder duration	28

Switching cooking programmes on and off automatically	28
Setting a cooking duration.....	28
At the end of the cooking duration:.....	29
Setting a cooking duration and finish time	29
Changing the cooking duration	30
Deleting a cooking duration	31
Deleting a finish time	31
Changing the time of day	32
Changing settings.....	32
Baking	34
Tips on baking	34
Notes on the cooking charts	34
Notes on the oven functions	35
Roasting	36
Tips for roasting	36
Notes on the cooking charts	36
Notes on the oven functions	37
Grilling	38
Tips for grilling.....	38
Notes on the cooking charts	38
Notes on the oven functions	39
Fan Grill 	40
Grill 	41
Other applications	42
Defrost	42
Low temperature cooking.....	43
Bottling.....	44
Drying.....	46
Frozen food/Ready meals.....	47
Heat crockery.....	47
Cleaning and care	48
Unsuitable cleaning agents.....	48
Removing normal soiling	49
Removing stubborn soiling (excluding the FlexiClip telescopic runners).....	49
Stubborn soiling on the FlexiClip telescopic runners.....	50
Cleaning the catalytic enamelled back panel.....	51
Removing soiling caused by spices, sugar and similar deposits	51
Removing oil and grease soiling	51

Contents

Removing the door	52
Fitting the door	53
Removing the shelf runners with FlexiClip telescopic runners.....	54
Lowering the top heat/grill element.....	54
Removing the back panel.....	55
Problem solving guide.....	56
Service.....	58
Contact in case of fault.....	58
Warranty	58
Installation.....	59
Building-in dimensions	59
Installation in a tall or base unit.....	59
Tall unit side view.....	60
Base unit side view.....	60
Connections and ventilation	61
Installing the oven	62
Electrical connection	62
Cooking charts.....	64
Creamed mixture	64
Rubbed in mixture	65
Yeast dough.....	66
Quark dough.....	67
Sponge mixture.....	67
Choux pastry, puff pastry, meringue.....	68
Savoury snacks	69
Beef	70
Veal.....	71
Pork.....	72
Lamb, game.....	73
Poultry, fish.....	74

Warning and Safety instructions

This oven complies with all current local and national safety requirements. However, inappropriate use can lead to personal injury and damage to property.

Read the operating and installation instructions carefully before using the oven for the first time. They contain important information on safety, installation, use and maintenance of the appliance. This prevents both personal injury and damage to the oven.

In accordance with standard IEC 60335-1, Miele expressly and strongly advises that you read and follow the instructions in “Installation”, as well as in the “Warning and Safety instructions”.

Miele cannot be held liable for injury or damage caused by non-compliance with these instructions.

Keep these instructions in a safe place and pass them on to any future owner.

Correct application

- ▶ This oven is designed for domestic use and for use in similar environments by guests in hotel or motel rooms, bed & breakfasts and other typical living quarters. This does not include common/shared facilities or commercial facilities within hotels, motels or bed & breakfasts.
- ▶ The oven is not suitable for outdoor use.
- ▶ The oven is intended for domestic use only to bake, roast, grill, cook, defrost, preserve, and dry food. Any other use is not permitted.
- ▶ This oven is not intended for use by persons (including children) with reduced physical, sensory or mental capabilities, or lack of experience and knowledge, unless they are supervised whilst using it. They may only use the oven unsupervised if they have been shown how to use it in a safe manner. They must be able to recognise and understand the dangers of misuse.
- ▶ The oven compartment is equipped with special lamps to cope with particular conditions (e.g. temperature, moisture, chemical resistance, abrasion resistance and vibration). These special lamps must only be used for the purpose for which they are intended. They are not suitable for room lighting.

Warning and Safety instructions

Safety with children

- ▶ Activate the system lock to ensure that children cannot switch on the oven inadvertently.
- ▶ Young children must not be allowed to use this appliance.
- ▶ Older children may only use the oven if its operation has been clearly explained to them and they are able to use it safely. They must be able to understand and recognise the possible dangers caused by incorrect operation.
- ▶ Cleaning work may only be carried out by older children under the supervision of an adult.
- ▶ Children should be supervised in the vicinity of the oven. Never allow children to play with the oven.
- ▶ Risk of suffocation from packaging material. Whilst playing, children may become entangled in packaging material (such as plastic wrapping) or pull it over their head with the risk of suffocation. Keep packaging material away from children.
- ▶ Risk of injury caused by hot surfaces. Children's skin is far more sensitive to high temperatures than that of adults. External parts of the oven such as the door glass, control panel and the vent become quite hot.
Do not let children touch the oven when it is in operation.
- ▶ Risk of injury from the open door. The oven door can support a maximum weight of 15 kg. Children could injure themselves on an open door.
Do not let children sit on the open door, lean against it or swing on it.

Technical safety

- ▶ Unauthorised installation, maintenance and repairs (including removal of any cover) can cause considerable danger for the user. Installation, maintenance and repairs must only be carried out by a Miele authorised technician.
- ▶ Damage to the oven can compromise your safety. Check the oven for visible signs of damage. Do not use a damaged oven.

Warning and Safety instructions

- ▶ Temporary or permanent operation with a self-sufficient or non-mains synchronous energy supply system (e.g. isolated networks, back-up systems) is possible. A requirement for the operation is that the energy supply system complies with all current local and national requirements that apply to stand-alone, solar and/or battery systems. The protective measures provided in the installation and in this Miele product must also be assured in their function and operation in isolated operation or in non-mains synchronous operation, or replaced with equivalent measures in the installation.
- ▶ The electrical safety of this appliance can only be guaranteed when continuity is complete between it and an effective earthing system. It is essential that this basic safety requirement is present and tested regularly. If in doubt, the electrical installation should be checked by a qualified electrician.
- ▶ The connection data (voltage and frequency) on the data plate of the oven must match the mains electricity supply in order to avoid the risk of damage to the oven. Compare this before connecting the appliance to the mains electricity. If in any doubt, consult a qualified electrician.
- ▶ Multi-socket adapters and extension leads do not guarantee the required safety of the appliance. Do not use these to connect the oven to the mains electricity supply.
- ▶ For safety reasons, the oven may only be used when it has been fully installed.
- ▶ This oven must not be installed and operated in mobile installations (e.g. on a ship).
- ▶ Risk of injury due to electric shock. Any contact with live connections or tampering with the electrical or mechanical components of the oven will endanger your safety and may lead to appliance malfunctions.
Do not open the oven housing under any circumstances.
- ▶ The manufacturer's warranty will be invalidated if the appliance is not repaired by a Miele approved service technician.
- ▶ Miele can only guarantee the safety of the appliance when original Miele spare parts are used. Faulty components must only be replaced by original spare parts.
- ▶ If the oven is delivered without a mains connection cable, a special cable must be installed by a suitably qualified and competent person (see "Installation - Electrical connection").





Warning and Safety instructions

- ▶ If the mains connection cable is damaged, it must be replaced with a special connection cable by a suitably qualified and competent person in order to avoid a hazard (see “Installation - Electrical connection”).
- ▶ During installation, maintenance and repair work, e.g. if the oven lighting is faulty, the oven must be completely disconnected from the electricity supply (see “Problem solving guide”). To ensure this:
 - Switch off the mains circuit breaker, or
 - switch off at the wall socket and withdraw the plug. To do this, pull the plug and not the mains connection cable.
- ▶ The oven requires a sufficient supply of cool air for efficient operation. Make sure that the supply of cool air is not hindered in any way (e.g. by heat insulation strips fitted in the housing unit). Furthermore, the required supply of cool air must not be excessively heated by other heat sources (e.g. solid fuel stoves).
- ▶ If the oven is built in behind a furniture front (e.g. a door), do not close the furniture door while the oven is in use. Heat and moisture can build up behind the closed furniture door. This can result in damage to the oven, housing unit and floor. Leave the furniture door open until the oven has cooled down completely.

Correct use

- ▶ Risk of injury caused by hot surfaces. The oven gets hot during operation. You could burn yourself on the heating elements, oven compartment, accessories or food. Wear oven gloves when placing food in the oven or removing it, and when adjusting oven shelves etc. in a hot oven.
- ▶ To avoid fuelling any flames, do not open the oven door if smoke occurs inside the appliance. Interrupt the process by switching the appliance off and disconnect it from the mains electricity supply. Do not open the door until the smoke has dispersed.
- ▶ Due to the high temperatures radiated, objects left near the oven could catch fire. Do not use the oven to heat up the room.
- ▶ Oils and fats can ignite if allowed to overheat. Never leave the oven unattended when cooking with oil or fats. Never attempt to put out oil or fat fires with water. Switch the oven off and extinguish the flames by leaving the door closed.

Warning and Safety instructions

- ▶ Grilling food for excessively long cooking durations can cause it to dry out with the risk of catching fire. Do not exceed the recommended cooking durations.
- ▶ Certain foods dry out quickly and may catch fire due to high grilling temperatures.
Never use a grill function to finish baking bake-off rolls or bread, or to dry flowers or herbs. Instead, use the Fan Plus  or Conventional Heat  function and always ensure this type of procedure is supervised.
- ▶ If using alcohol in your recipes, please be aware that high temperatures can cause the alcohol to evaporate. The vapour can catch fire on hot heating elements.
- ▶ When using residual heat to keep food warm, corrosion from high air humidity and condensation can occur in the oven. This can also cause damage to the control panel, worktop and surrounding kitchen furniture. Keep the oven on and select the lowest temperature available for the selected function. The cooling fan will then continue to run and dissipate the moisture.
- ▶ Food which is stored in the oven compartment or left in it to be kept warm can dry out and the moisture released can lead to corrosion damage in the oven. Always cover food that is left in the oven to keep warm.
- ▶ An accumulation of heat can cause the enamel on the floor of the oven to crack or flake off.
Never line the floor of the oven compartment with aluminium foil or oven liners.
If you wish to place crockery on the oven floor during cooking, or place crockery on the oven floor to heat it up, you can do so, but only with the Fan Plus  or Eco Fan Heat  function.
- ▶ The oven compartment floor can become damaged by items being pushed around on it. When placing pots, pans or crockery on the oven compartment floor, ensure that you avoid pushing them around.
- ▶ Danger of injury caused by steam. Pouring a cold liquid onto a hot surface creates steam, which can cause severe scalding. The sudden temperature change can also cause damage to hot surfaces. Never pour cold liquids directly onto hot surfaces.
- ▶ It is important that the temperature in the food being cooked is evenly distributed and sufficiently high. This can be achieved by stirring or turning the food.

Warning and Safety instructions

- ▶ Plastic dishes that are not suitable for use in an oven will melt and may ignite at high temperatures and damage the oven. Use only plastic containers that are suitable for use in an oven. Follow the manufacturer's instructions.
- ▶ Preserving and heating food in sealed tins will result in an increase in pressure, which can cause them to explode. Do not use tins for preserving or heating food.
- ▶ Risk of injury from the open door. You could bang into the open door or trip over it. Avoid leaving the door open unnecessarily.
- ▶ The door can support a maximum load of 15 kg. Do not lean or sit on an open door, or place heavy items on it. Make sure that nothing gets trapped between the door and the oven compartment. This could damage the oven.

The following applies for stainless steel surfaces:

- ▶ The coated stainless steel surface can be damaged by adhesives and will lose its dirt-repelling properties. Do not use sticky notes, adhesive tape or other types of adhesive on the stainless steel surface.
- ▶ Magnets can cause scratches. Do not use the stainless steel surface as a magnetic notice board.

Cleaning and care

- ▶ Risk of injury due to electric shock. The steam from a steam cleaning appliance could reach electrical components and cause a short circuit. Never use a steam cleaner for cleaning.
- ▶ Scratches on the door glass can cause the glass to break. Do not use abrasive cleaners, hard sponges, brushes or sharp metal tools to clean the door glass.
- ▶ The shelf runners can be removed (see "Cleaning and care – Removing the shelf runners with FlexiClip telescopic runners"). Refit the shelf runners correctly.
- ▶ The catalytic enamelled back panel can be removed for cleaning purposes (see "Cleaning and care - Removing the back panel"). Ensure it is correctly fitted after cleaning and never operate the oven without the back panel fitted.

Warning and Safety instructions

- ▶ In warm, moist environments, there is a higher probability of vermin infestations (e.g. cockroaches). Ensure the oven and the area surrounding it are always kept clean.
Damage caused by vermin is not covered by the warranty.

Accessories

- ▶ Only use original Miele accessories. If other parts are used, warranty, performance and product liability claims will be invalidated.
- ▶ Miele will guarantee to supply functional spare parts for a minimum of 10 years and up to 15 years following the discontinuation of your oven.

Caring for the environment

Disposal of the packing material

The transport and protective packaging has been selected from materials which are environmentally friendly for disposal, and can normally be recycled.

Recycling the packaging reduces the use of raw materials in the manufacturing process and also reduces the amount of waste in landfill sites.

Ensure that any plastic wrappings, bags etc. are disposed of safely and kept out of the reach of babies and young children. Danger of suffocation.

Disposing of your old appliance

Electrical and electronic appliances often contain valuable materials. They also contain specific materials, compounds and components, which were essential for their correct function and safety. These could be hazardous to human health and to the environment if disposed of with your domestic waste or if handled incorrectly. Please do not, therefore, dispose of your old appliance with your household waste.



Please dispose of it at your local community waste collection / recycling centre for electrical and electronic appliances. You are also responsible for deleting any personal data that may be stored on the appliance prior to disposal. Please ensure that your old appliance poses no risk to children while being stored prior to disposal.

Oven overview

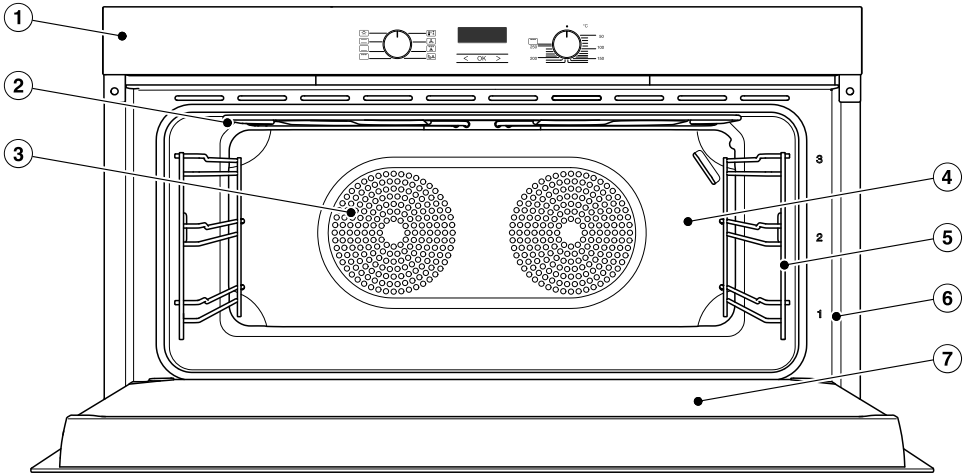

- ① Control panel
- ② Top heat/grill element
- ③ Air inlets for the fans with ring heating element behind them
- ④ Catalytic enameled back panel
- ⑤ Shelf runners with 3 shelf levels
- ⑥ Front frame with data plate
- ⑦ Door

Oven controls

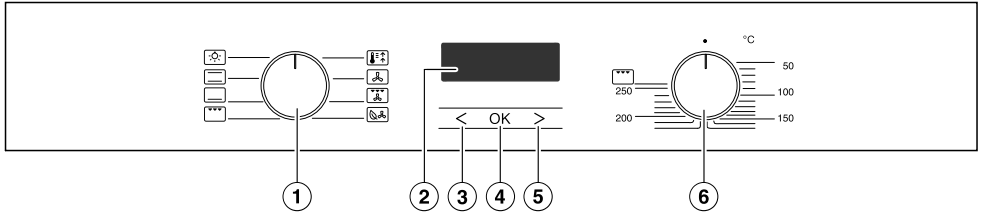

- ① Function selector
For selecting oven functions
- ② Clock/Timer
For displaying the time of day and settings
- ③ < sensor
For changing times and settings
- ④ OK sensor
For calling up functions and saving settings
- ⑤ > sensor
For changing times and settings
- ⑥ Temperature selector
For setting the temperature









Function selector

The function selector is used to select oven functions and to switch on the oven lighting separately.

The function selector can be turned clockwise or anti-clockwise.

When the function selector is in the **O** position, it can be retracted by pushing it in.

Oven functions

-  Lighting
-  Conventional Heat
-  Bottom Heat
-  Full Grill
-  Booster
-  Fan Plus
-  Fan Grill
-  Eco Fan Heat

Temperature selector

Use the temperature selector to select the temperature for the cooking processes.

It can be turned clockwise until a resistance is felt and then turned back again. When the selector is in the **•** position, it can be retracted by pushing it in.

The temperature settings are marked on the temperature selector and on the control panel.

Clock/Timer

The clock/timer is operated via the **display** and the **<**, **OK** and **>** **sensor controls**.

Display

The display shows the time of day or your settings.

It goes dark if settings are not being entered.

Please refer to “Clock/Timer” for more information.

Sensor controls

The sensor controls respond to the touch of a fingertip. Every touch on the sensors is confirmed by an audible tone. The keypad tone can be switched off by changing setting **P 4** to status **5 1** (see “Clock/Timer - Changing settings”).

Features

A list of the models described in these operating and installation instructions can be found on the back page.

Data plate

The data plate located on the front frame of the oven is visible when the door is open.

The data plate states the model number, the serial number as well as connection data (voltage, frequency and maximum rated load).

Have this information available if you need to contact Miele so that any issues can be rectified as quickly as possible.

Items supplied

- Operating and installation instructions for using the oven
- Screws for fixing the oven to the housing unit
- Various accessories

Standard and optional accessories

Features will vary depending on model.

The shelf runners, universal tray and wire rack (or “rack” for short) are supplied as standard with the oven.

Depending on the model, your oven may also come supplied with some of the accessories listed here.

All accessories and cleaning and care products listed in these instructions are designed for Miele ovens.

These are available to order via the Miele online shop or directly from Miele (see the end of this booklet for contact details).

When ordering, please quote the model number of your oven and the reference number of the accessories required.

Shelf runners

Shelf runners for accessories are fitted on either side of the oven cavity for shelf levels \square_1^3 .

The shelf level numbers are marked on the front of the oven frame.

Each level consists of 2 rails, one above the other.

Accessories (e.g. the rack) are pushed into the oven between the two rails.

The FlexiClip telescopic runners (if present) are fitted on the lower rail.

The shelf runners can be removed (see “Cleaning and care – Removing the shelf runners with FlexiClip telescopic runners”).

Universal tray and rack with non-tip safety notches

Universal tray HUBB:

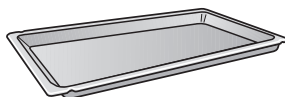

Rack HBBR:

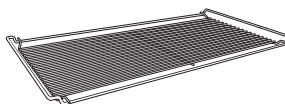

Insert these accessories into the shelf runners between the two rails of a shelf level.

Always insert the rack as illustrated above with the loading surface in the lower position.

These accessories have non-tip safety notches located towards the back of the short sides. The non-tip safety notches prevent the accessories from being

pulled out completely from the shelf runners when you only wish to pull accessories out partially. They also prevent accessories from tipping.

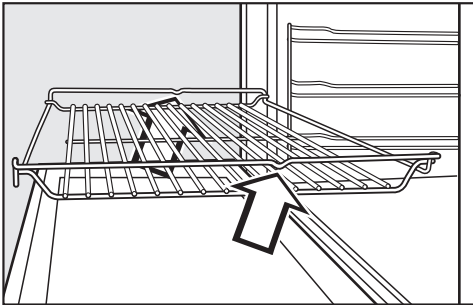
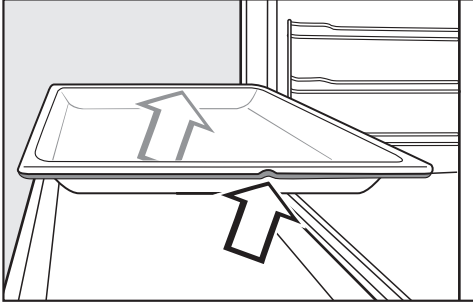

Always place the accessories in the shelf runners with the non-tip safety notches towards the back.

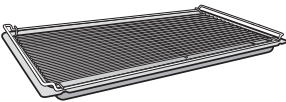

If you are using the universal tray with the rack on top, insert the tray between the rails of the shelf runners and the rack will automatically slide in above them.

FlexiClip telescopic runners HFC 9x

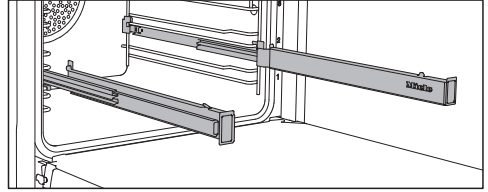

You can use the FlexiClip telescopic runners on shelf levels 1–3.

Push the FlexiClip telescopic runners right into the oven cavity before placing accessories on them.

The accessories will then automatically sit securely between the stoppers at either end of each runner and be prevented from sliding off.

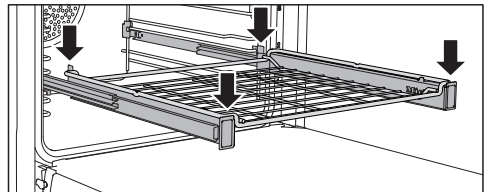
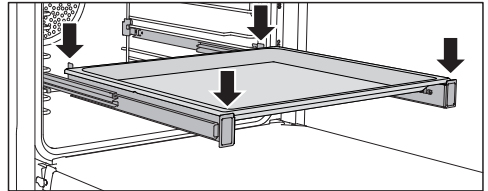

The FlexiClip telescopic runners can support a maximum load of 15 kg.

Features

Fitting and removing the FlexiClip telescopic runners

 Risk of injury caused by hot surfaces.

The oven gets hot during operation. You could burn yourself on the heating elements, the oven compartment, or accessories.

Allow the heating elements, oven compartment and the accessories to cool down before fitting or removing the FlexiClip telescopic runners.

The FlexiClip telescopic runners are fitted in between the two rails that make up a shelf level.

The FlexiClip telescopic runner with the Miele logo is fitted on the right.

When fitting or removing the FlexiClip telescopic runners, do **not** extend them.

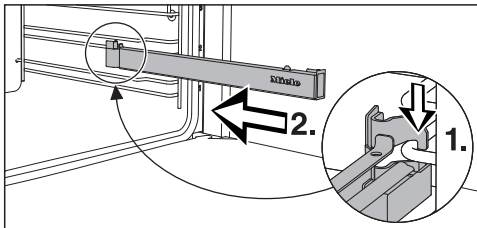

- Hook the FlexiClip telescopic runner onto the lower rail of a shelf level at the front (1.) and push it along the rail into the oven interior (2.).

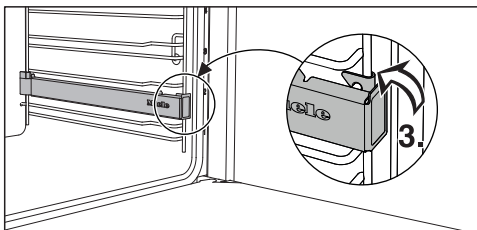

- Then secure the FlexiClip telescopic runner to the lower rail of the shelf level as illustrated (3.).

If the FlexiClip telescopic runners are difficult to pull out after fitting, you may need to pull firmly on them once to release them.

To remove a FlexiClip telescopic runner, proceed as follows:

- Push the FlexiClip telescopic runner in all the way.

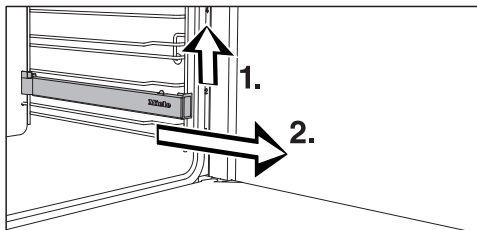

- Remove the FlexiClip telescopic runner by raising it at the front (1.) and then pulling it forwards along the rail of the shelf level and out (2.).

Grilling and roasting insert HGBB 92

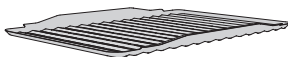

The grilling and roasting insert fits in the universal tray.

The tray will collect meat juices during grilling, roasting or AirFrying and stop them from burning so that they can be used for making gravy and sauces.

The enamelled surface has been treated with PerfectClean.

Round baking trays



The **solid round baking tray HBF 27-1** is suitable for cooking pizzas, flat cakes made with yeast or whisked mixtures, sweet and savoury tarts, baked desserts, flat bread, and can also be used for frozen cakes and pizzas.

The **perforated round baking and AirFry tray HBFP 27-1** can be used for the same purposes as the **perforated Gourmet baking and AirFry tray HBBL 71**.

The surface of both baking trays has been treated with PerfectClean enamel.

- Insert the rack and place the round baking tray on the rack.

HUB Gourmet oven dishes HBD Gourmet oven dish lids

Miele Gourmet oven dishes can be placed directly on the rack. The surface of the Gourmet oven dishes has a nonstick coating and is suitable for induction cooktops.

Gourmet oven dishes are available in different depths. The width and the height are the same.

Suitable lids are available separately. Please quote the model number when ordering.

Insert the rack in shelf level 1 and place the Gourmet oven dish on the rack.

Depth: 22 cm

HUB 62-22

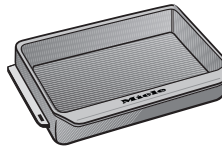

HBD 60-22

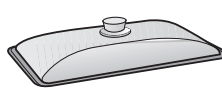

Depth: 35 cm*

HUB 62-35

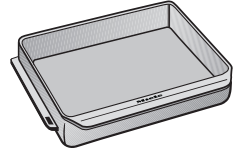

HBD 60-35

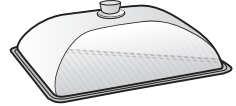

- * The oven dish cannot be used in conjunction with its lid in ovens with three shelf levels because the total height of these two items exceeds the height of the oven cavity.

Baking stone HBS 70



The baking stone is ideal for items which need a well baked base such as pizza, quiche, bread, bread rolls and savoury snacks.

The baking stone is made from heat-retaining fireclay and is glazed. A paddle made of untreated wood is supplied with the baking stone for placing food on it and taking it off.

- Slide the rack in and place the baking stone on it.

Catalytic enamelled accessories

Catalytic enamelled surfaces are self-cleaning, which means that oil and fat are burnt off automatically when very high temperatures are reached inside the oven. See "Cleaning and care" for more information.

Features

Back panel

This should be replaced if the catalytic enamel has become ineffective due to incorrect use or very heavy soiling.

When ordering, please quote the model number of your oven.

Accessories for cleaning and care

- Miele all purpose microfibre cloth
- Miele oven cleaner

Safety features

- **System lock**  for the oven (see “Clock/Timer - Changing settings”).
- **Cooling fan**
The cooling fan will come on automatically when a cooking programme is started. It ensures that the hot air in the oven compartment is mixed with cool ambient air and thus cooled before it is expelled via the gap between the door and the control panel.
The cooling fan will continue to run for a while after the oven has been switched off to prevent humidity building up in the oven compartment, on the control panel or on the oven housing unit.
The cooling fan will switch itself off automatically after a certain period of time.
- **Ventilated door**
The oven door is made of glass panes that have a heat-reflective coating on part of their surface. When the oven is operating, air is passed through the door to keep the outer pane cool.

PerfectClean treated surfaces

Surfaces treated with PerfectClean enamel are characterised by their exceptional non-stick properties and ease of cleaning.

Food can be easily removed from these surfaces. Soiling from baking and roasting can be easily removed from these surfaces.

Food can be sliced or cut up on PerfectClean surfaces.

However, do not use ceramic knives as these will scratch the PerfectClean surface.

Surfaces treated with PerfectClean enamel can be cleaned as you would clean glass.

Read the instructions in “Cleaning and care” so that the benefits of the non-stick properties and easy cleaning are retained.

PerfectClean treated surfaces:

- Oven compartment
- Universal tray
- Grilling and roasting insert
- Round baking and AirFry tray, perforated
- Round baking tray

Before using for the first time

Before using for the first time

 The oven must be built into its housing unit before it can be used.

- Press and release the function and temperature selectors if they are retracted.

The time of day can only be changed when the function selector is at **0**.

- Set the time of day.

Setting the time of day for the first time

The time of day is shown in the 24-hour format.



12:00

After connecting the oven to the electricity supply, *12:00* flashes in the display.

The time of day is set in segments: first the hours, then the minutes.

- Confirm with *OK*.

The hours will flash.

- Use *<* or *>* to set the hours.

- Confirm with *OK*.

The hours are saved and the minutes will flash.

- Use *<* or *>* to set the minutes.

- Confirm with *OK*.

The time of day is now saved.

The time of day can be displayed in 12-hour format by setting *P 2* in the settings menu to status *12* (see “Clock/Timer - Changing settings”).

Before using for the first time

Heating up the oven for the first time

When the oven is heated up for the first time it may give off a slight smell. This can be eliminated by heating the empty oven for at least an hour.

Ensure that the kitchen is well ventilated while the appliance is being heated up for the first time. Prevent odours from escaping into other rooms.

- Remove any protective foil and stickers except the data plate from the oven and accessories.
- Before heating the oven up, wipe the interior with a damp cloth to remove any dust or bits of packaging that may have accumulated during storage and unpacking.
- Fit the FlexiClip telescopic runners (if present) to the shelf runners and insert all trays and the rack.
- Select Fan Plus .

The oven heating, lighting and cooling fan will switch on.

- Select the maximum temperature (250 °C).
- Heat up the empty oven for at least one hour.
- At the end of the heating up time, turn the function selector to **O** and the temperature selector to **•**.

Cleaning the oven compartment after heating it up for the first time

 Risk of injury caused by hot surfaces.



The oven gets hot during operation. You could burn yourself on the heating elements, the oven compartment, or accessories.

Allow the heating elements, oven compartment and the accessories to cool before manual cleaning.

- Take all accessories out of the oven and clean them by hand (see “Cleaning and care”).
- Clean the oven compartment with a clean sponge and a solution of hot water and washing-up liquid or a clean, damp microfibre cloth.
- Dry all surfaces with a soft cloth.

Leave the oven door open until the oven interior is completely dry.

Cooking programmes

- Remove any accessories from the oven that are not required for a cooking programme.
- In general, if a range of temperatures is given in a recipe or chart, it is best to select the lower temperature and to check the food after the shortest duration.
- Pre-heat the oven only if instructed to do so in the recipe or the cooking chart.
- Avoid opening the door during a cooking process.
- It is best to use dark bakeware and cooking containers with a matt finish made of non-reflective materials (enamelled steel, heat-resistant glass, non-stick coated cast aluminium). Shiny materials such as stainless steel or aluminium reflect the heat, preventing it from reaching the food efficiently. Do not cover the oven floor or the rack with heat-reflective aluminium foil.
- Monitor cooking durations to avoid wasting energy when cooking food. Set the cooking duration or use a food probe if you have one.
- The Fan Plus  function can be used for cooking many types of food. Because the fan distributes the heat in the oven compartment straight away, it allows you to use a lower temperature than you would with Conventional Heat . It also enables you to cook on several shelf levels at the same time.
- Eco Fan Heat  is an innovative function which is suitable for small amounts of food, e.g. frozen pizzas, bake-off rolls, biscuits and for meat dishes and roasts. The cooking

process is energy-efficient thanks to optimal utilisation of heat. When cooking on a single level, up to 30% less energy is used with comparatively good cooking results. Do not open the door during the cooking programme.

- Fan Grill  is the best function for grilled dishes. With Fan Grill you can use lower temperatures than with other grill functions which use the maximum temperature setting.
- Whenever possible you should cook several dishes at the same time. Place them next to each other in the oven or on different shelf levels.
- Dishes which you are unable to prepare at the same time should, if possible, be cooked one after the other in order to make use of existing heat in the oven.

Using residual heat

- The temperature in cooking programmes using temperatures above 140 °C which take longer than 30 minutes to cook can be turned down to the lowest possible temperature about 5 minutes before the end of cooking. The residual heat in the oven is sufficient for cooking the food. However, do not switch the oven off (see “Warning and safety instructions”).
- If you wish to run the programme for cleaning oil and grease off the catalytic enamelled parts of the oven, it is best to do so immediately after a cooking programme. The residual heat in the oven will help reduce the amount of energy required.

Operation

Basic operation

- Place the food in the oven.
- Select the required oven function with the function selector.

The oven lighting and the fan will switch on.

- Select the temperature with the temperature selector.

The oven heating is switched on and the temperature indicator light  lights up in the display next to the time of day:



The temperature indicator light  lights up whenever the oven heating is switched on.

As soon as the set temperature is reached:

- the oven heating switches off
- the temperature indicator light goes out.

The temperature control unit ensures that the oven heating and the temperature indicator light switch back on if the oven temperature falls below the level set.

After the cooking process:

- Turn the function selector to **O** and the temperature selector to **•**.
- Take the food out of the oven.

Cooling fan



The cooling fan will continue to run for a while after the oven has been switched off to prevent any humidity building up in the oven, on the control panel or in the oven housing unit.

The cooling fan will switch itself off automatically after a certain period of time.

Pre-heating the oven

The Booster function is used to quickly pre-heat the oven.

It is only necessary to pre-heat the oven in a few instances.

- Most dishes can be placed in a cold oven. They will then make use of the heat produced during the heating-up phase.
- Pre-heat the oven for the following preparations and oven functions:
 - Dark bread dough and beef sirloin joints and fillet with the Fan Plus  and Conventional Heat  functions
 - Cakes and pastries with a short cooking duration (up to approx. 30 minutes) and delicate items (e.g. sponge) with the Conventional Heat  function

Rapid Heat-up

You can shorten the heating-up phase with the Booster  function.

Do not use the Booster  function to pre-heat the oven when baking pizzas or delicate mixtures (e.g. sponge cake, biscuits). This food will otherwise brown too quickly from the top.

- Select Booster .
- Select the temperature.
- Change to the required oven function after the set temperature has been reached.
- Place the food in the oven.

The clock/timer offers the following functions:

- Time of day display
- Minute minder
- Switching cooking processes on and off automatically
- Altering various settings *P*

The clock/timer is operated via the **display** and the **OK** and **< >** sensors.

The functions available are indicated by symbols.

Display

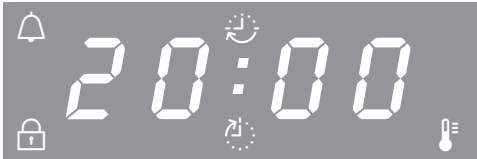

Symbols in the display

Depending on the position of the function selector \bigcirc and/or whether a sensor has been pressed, the following symbols will appear:

Symbol/Function		\bigcirc
	Minute minder	Any
	Duration	Oven function
	Finish time	
	Temperature indicator light	
<i>P</i>	Settings	0
<i>S</i>	Setting status	
	System lock	

You can only set or change a function if the function selector is in the correct position.

Sensor controls

Sensor	Use
<	<ul style="list-style-type: none"> - Highlighting functions - Reducing times - Calling up settings <i>P</i> - Changing the status <i>S</i> of a setting <i>P</i>
>	<ul style="list-style-type: none"> - Highlighting functions - Increasing times - Changing the status <i>S</i> of a setting <i>P</i>
OK	<ul style="list-style-type: none"> - Calling up functions - Saving set times and adjusted settings - Calling up set times

Set hours, minutes and seconds with the < or > sensor in increments of 1. If you hold the sensor down the display will count faster.



Clock/Timer

How to set the time or a duration

Times are set in segments:

- for the time of day and cooking durations, first the hours, then the minutes.
- for a minute minder duration, first the minutes, then the seconds.

■ Confirm with *OK*.

Depending on the position of the function selector, the functions ,  or  will appear.

■ Highlight the required function using the < or > sensor.

The corresponding symbol will flash for approx. 15 seconds.

■ While the symbol is flashing, confirm with *OK*.

The function is selected and the left numeric block will start to flash.

You can only set the time while the numeric block is flashing. If the time has elapsed and the numeric block is no longer flashing, you have to select the function again.

■ Set the required value using the < or > sensor.

■ Confirm with *OK*.



The right numeric block will flash.



■ Set the required value using the < or > sensor.

■ Confirm with *OK*.

Your time/duration setting is now saved.

Displaying times/durations

If you have set times, the symbols  and  or  indicate which time functions have been set.

If you are using the minute minder , cooking duration  and end of cooking time  functions simultaneously, the last time that you set will be displayed.

If you have set a cooking duration, the time of day cannot be displayed.

When the time/duration has elapsed

Once a set time has elapsed, the relevant symbol will flash and a signal will sound, if this option is selected (see “Clock/Timer - Changing settings”).

■ Confirm with *OK*.

The signal tone will stop and the symbols in the display will go out.

Using the minute minder

The minute minder can be used to time other activities in the kitchen, e.g. boiling eggs.

The minute minder can also be used at the same time as a cooking programme for which the duration and finish times have been set, e.g. as a reminder to stir a dish or add seasoning etc.

A maximum minute minder time of 99 minutes and 59 seconds can be set.

Setting the minute minder

Example: You want to boil some eggs and set a minute minder time of 6 minutes and 20 seconds.

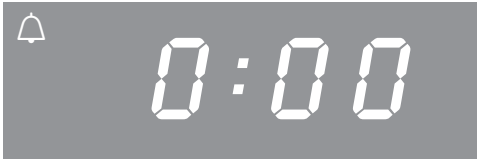

- Press < repeatedly until  starts flashing.
- Confirm with *OK*.

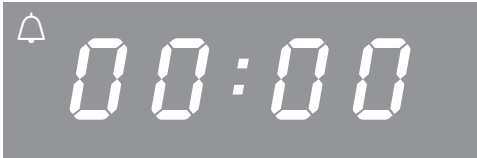

00:00 appears in the display and the minutes will flash.

If you press < once, two lines will appear and, after pressing it again, the maximum possible minute value 99 will appear.



- Use < or > to set the minutes.
- Confirm with *OK*.

The minutes are saved and the seconds will flash.



- Set the seconds using < or >.
- Confirm with *OK*.



The minute minder is saved and will count down in seconds.

The  symbol indicates the minute minder has been set.

At the end of the minute minder time

-  flashes.
- The time will count upwards.
- A signal tone will sound for approx. 7 minutes, if this option is selected (see "Clock/Timer - Changing settings").

- Confirm with *OK*.

The signal tone will stop and the symbols in the display will go out.

If no cooking duration has been set, the time of day will appear in the display.

Clock/Timer

Changing the time set for the minute minder

- Press < repeatedly until  starts flashing.

The set minute minder time will appear.

- Confirm with *OK*.

The minutes will flash.

- Use < or > to set the minutes.

- Confirm with *OK*.

The seconds will flash.

- Use < or > to set the seconds.

- Confirm with *OK*.

The changed minute minder time is saved and will count down in seconds.

Cancelling the minute minder duration

- Press < repeatedly until  starts flashing.

- Confirm with *OK*.

The minutes will flash.

- Decrease the minutes to *00* by pressing <, or increase them to *99* by pressing >.

The next time the sensor is pressed two lines will appear in place of the minutes.

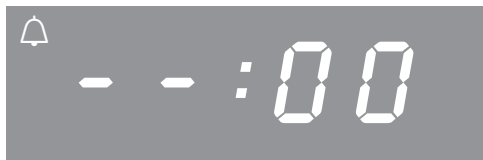

- Confirm with *OK*.

Four lines appear:



- Confirm with *OK*.

The minute minder is now cancelled.

If no cooking duration has been set, the time of day appears in the display.

Switching cooking programmes on and off automatically

Cooking programmes can be switched on or off automatically.

To do this, set a duration or a duration and finish time after selecting an oven function and a temperature.

The maximum duration which can be set for a cooking programme is 11 hours and 59 minutes.

We recommend using automatic switching on and off when roasting. However, do not delay the start for too long when baking as the cake mixture or dough will dry out, and the raising agents will lose their effectiveness.

Setting a cooking duration

Example: To bake a cake for 1 hour and 5 minutes:

- Place the food in the oven.
- Select the required oven function and the temperature.

The oven heating, lighting and cooling fan will switch on.

- Press > repeatedly until  starts flashing.



0:00 appears in the display.

- Confirm with *OK*.



00:00 appears in the display and the hours will flash.

If you press < once, two lines will appear and, after pressing again, the maximum possible hour value // will appear.



- Use < or > to set the hours.
- Confirm with *OK*.

The hours are saved and the minutes will flash.



- Use < or > to set the minutes.
- Confirm with *OK*.



The cooking duration is saved and then counts down in minutes, with the last minute counting down in seconds.

The 🕒 symbol indicates a cooking duration has been set.

At the end of the cooking duration:

- 0:00 appears in the display.
- 🕒 flashes.
- The oven heating switches off automatically.
- The cooling fan continues to run.
- A buzzer will sound for approx. 7 minutes, if this option is selected (see “Clock/Timer - Changing settings”).
- Confirm with *OK*.
- The buzzer will stop and the symbols in the display will go out.
- The time of day appears.
- The oven heating will switch back on.
- Turn the function selector to **0** and the temperature selector to **•**.
- Take the food out of the oven.

Setting a cooking duration and finish time

A cooking duration and finish time can be set to switch a cooking programme on and off automatically.

Example: The time is now 11:15; you want a dish with a cooking duration of 90 minutes to be ready by 13:30.

- Place the food in the oven.
- Select the required oven function and the temperature.

The oven heating, lighting and cooling fan will switch on.

Clock/Timer

Set the cooking duration first:

■ Press > repeatedly until  starts flashing.

■ Confirm with *OK*.

00:00 appears in the display and the hours will flash.

■ Use < or > to set the hours.

■ Confirm with *OK*.

The hours are saved and the minutes will flash.

■ Use < or > to set the minutes.

■ Confirm with *OK*.

The cooking duration is now saved.



The  symbol indicates a cooking duration has been set.

Then set the finish time:

■ Press > repeatedly until  starts flashing.

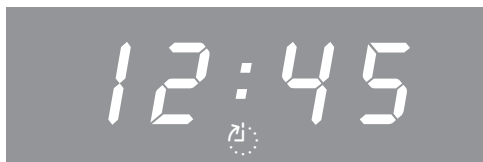

12:45 appears in the display (current time of day + cooking duration = 11:15 + 1:30).

■ Confirm with *OK*.

The hours will flash.



■ Use < or > to set the hours.

■ Confirm with *OK*.

The hours are saved and the minutes will flash.



■ Use < or > to set the minutes.

■ Confirm with *OK*.

The finish time  is now saved.

The oven heating, lighting and cooling fan will switch off.

The selected finish time appears in the display.

As soon as the start time (13:30 - 1:30 = 12:00) is reached, the oven heating, lighting and cooling fan will switch on.

The set cooking duration  appears and then counts down in minutes, with the last minute counting down in seconds.

Changing the cooking duration

■ Press > repeatedly until  starts flashing.

The remaining cooking duration appears in the display.

■ Confirm with *OK*.

The hours will flash.

■ Use < or > to set the hours.

■ Confirm with *OK*.

The minutes will flash.

- Use < or > to set the minutes.
- Confirm with *OK*.

The changed cooking duration is now saved.

Deleting a cooking duration

- Press < or > repeatedly until  starts to flash.
- Confirm with *OK*.

The hours will flash.

- Press < or > repeatedly until two lines appear:

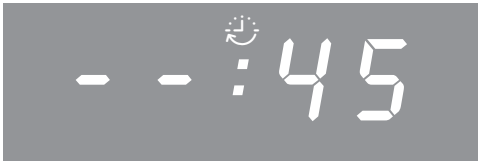

- Confirm with *OK*.

Four lines appear:



- Confirm with *OK*.

The cooking duration and any finish time are deleted.

The time of day appears if no minute minder has been set.

The oven heating, lighting and cooling fan will switch on.

If you want to end the cooking programme:

- Turn the function selector to **0** and the temperature selector to **•**.
- Take the food out of the oven.

Deleting a finish time

- Press < or > repeatedly until  starts to flash.
- Confirm with *OK*.

The hours will flash.

- Press < or > repeatedly until two lines appear:
- Confirm with *OK*.

Four lines appear:

- Confirm with *OK*.

The  symbol appears and the set cooking duration counts down in minutes, with the last minute counting down in seconds.

If you want to end the cooking programme:

- Turn the function selector to **0** and the temperature selector to **•**.
- Take the food out of the oven.

If you turn the function selector to **0**, the settings for the cooking duration and the finish time will be deleted.

Clock/Timer

Changing the time of day

The time of day can only be changed when the function selector is at **0**.

- Turn the function selector to **0**.
- Press **<** and **>** at the same time.

The hours will flash.

- Use **<** or **>** to set the hours.
- Confirm with **OK**.

The hours are saved and the minutes will flash.

- Use **<** or **>** to set the minutes.
- Confirm with **OK**.

The time of day is now saved.

After a power cut, the time of day needs to be re-entered.

Changing settings

Your appliance is supplied with a number of standard default settings (see the “Settings overview” chart).

A setting **P** is changed by altering its status **S**.

- Turn the function selector to **0**.
- Press and hold **<** until **P** appears.



- If you want to change another setting, press **<** or **>** repeatedly until the relevant number appears.
- Confirm with **OK**.



The setting is selected and the current status **S** appears, e.g. **0**.

To change the status:

- Press **<** or **>** repeatedly until the required status appears in the display.
- Confirm with **OK**.

The selected status is saved and the setting **P** appears again.

To change further settings, proceed in the same way.

If you do not want to change any further settings:

- Wait approx. 15 seconds until the time of day appears.

Settings remain in the memory even after a power cut.

Settings overview

Setting	Status
<i>P 1</i> Buzzer volume	<i>5 0</i> The buzzer is switched off .
	<i>5 1</i> to <i>5 30*</i> The buzzer is switched on . The volume can be altered. When you select a status, you will hear the corresponding buzzer.
<i>P 2</i> Clock format	<i>24*</i> The time of day is shown in the 24-hour format .
	<i>12</i> The time of day is shown in the 12-hour format . If you change the clock after 1:00 pm from a 12-hour clock to a 24-hour clock you will need to update the hour accordingly.
<i>P 3</i> System lock for the oven	<i>5 0*</i> The system lock is switched off .
	<i>5 1</i> The system lock is on and  appears in the display. The system lock prevents the oven from being used inadvertently, for example by children. The system lock remains active even after a power cut.

* Factory default

Baking

Handling food carefully will help protect your health.

Cakes, pizzas and chips should be cooked until golden, not dark brown.

Tips on baking

- Set a cooking duration. When baking, the oven should not be set to start a long time off. Otherwise the cake mixture or dough will dry out, and the raising agents will lose their effectiveness.
- Generally, you can use the rack, baking tray, universal tray and any type of baking tray made of heat-resistant material.
- Avoid using bright, thin-walled tins as they give an uneven or poor browning result. In certain unfavourable conditions, the food will not cook properly.
- Place cakes in rectangular tins on the rack with the longer side across the width of the oven for optimum heat distribution and even results.
- Always place bakeware on the rack.
- Bake cakes with fruit toppings or deep cakes on the universal tray.

Using baking paper

Miele accessories, e.g. the universal tray, are treated with PerfectClean enamel (see “Features”). Surfaces treated with PerfectClean enamel generally do not need to be greased or covered with baking paper.

- Use baking paper when baking lye pastries (e.g. pretzels) because the sodium hydroxide can damage the PerfectClean treated surface.
- Use baking paper when baking sponge, meringue, macaroons or similar items. These are more likely to stick due to their high egg white content.
- Use baking paper when cooking frozen food on the rack.

Notes on the cooking charts

You can find the cooking charts at the end of this book.

Selecting the temperature

- As a general rule, select the lower temperature given in the chart. Baking at temperatures higher than those recommended may reduce the cooking duration, but will lead to uneven browning of the food, and unsatisfactory cooking results.

Selecting the cooking duration

Unless otherwise stated, the cooking durations given in the cooking charts are for an oven compartment which has not been pre-heated. With a pre-heated oven compartment, shorten durations by around 10 minutes.

- As a general rule, check whether the food is cooked after the shortest duration. Stick a wooden skewer into the food.

If it comes out clean without any batter/dough on it, the food is done.

Notes on the oven functions

You can find an overview of all the functions with their recommended values in "Overview of functions".

Using Fan Plus

Because the fan distributes the heat around the oven compartment straight away, you can use a lower temperature than you would with the Conventional Heat  function.

Use this function if you are baking on multiple shelf levels at the same time.

- 1 shelf: Place the food on shelf level 1.
- 2 shelves: Place the food on shelf levels 1+3.

Useful tips

- If you are cooking on multiple shelf levels at the same time, slide the universal tray in on the lowest level.
- For moist biscuits and cakes, bake on a maximum of 2 shelf levels at once.

Using Conventional Heat

Dark metal, enamel, or aluminium bakeware with a matt finish, as well as heat-resistant glass, ceramic, and coated bakeware can be used.

Use this function for baking traditional recipes. If using an older recipe or cookbook, set the oven temperature 10 °C lower than that recommended. This will not change the cooking duration.

- Place the food on shelf level 1 or 2.

Using Eco Fan Heat

Use this function for cooking small amounts of food, e.g. frozen pizzas, bake-off rolls or biscuits, while saving energy.

- Place the food on shelf level 2.

Roasting

Tips for roasting

- You can use any crockery made from temperature-resistant materials, e.g. oven dishes, roasting pans with lid, ovenproof glass dishes, roasting bags, dishes made from earthenware or cast iron, the universal tray, rack and/or grilling and roasting insert (if present) on top of the universal tray.
- **Pre-heating** the oven compartment is only required when roasting beef sirloin joints and fillet. Pre-heating is generally not necessary.
- Use a **closed roasting dish** for roasting meat, such as an oven dish. The meat stays succulent. The oven compartment will also stay cleaner than when roasting on the rack. It ensures that sufficient stock remains for making gravy.
- If you are using a **roasting bag**, follow the instructions on the packaging.
- If you are using the **rack** or an **open roasting dish** for roasting, you can add a little fat or oil to very lean meat or place a few strips of streaky bacon on the top.
- **Season** the meat and place in the roasting dish. Dot with butter or margarine or brush with oil or cooking fat if necessary. For large lean cuts of meat (2–3 kg) and fatty poultry, add about 1/8 l of water to the dish.
- Do not add too much liquid during cooking as this will hinder the **browning** of the meat. Browning only occurs towards the end of the cooking duration. Remove the lid about halfway through the cooking duration if a more intensive browning result is desired.



- At the end of the programme, take the food out of the oven compartment, cover it and leave to **stand** for about 10 minutes. This helps retain juices when the meat is carved.
- For a crisp finish, baste **poultry** 10 minutes before the end of the cooking duration with slightly salted water.

Notes on the cooking charts

You can find the cooking charts at the end of this book.

- Take note of the temperature range, the shelf levels and the timings. These also take the type of cooking container, the size of the meat and cooking practices into account.

Selecting the temperature

- As a general rule, select the lower temperature given in the chart. If higher temperatures are used than those specified, the meat will brown on the outside, but will not be properly cooked through.
- When cooking with Fan Plus , select a temperature 20 °C lower than when using Conventional Heat .
- For cuts which weigh more than 3 kg, select a temperature approx. 10 °C lower than that given in the cooking chart. The roasting process will take longer, but the meat will cook evenly through and the skin or crackling will not be too thick.
- When roasting on the rack, set a temperature approx. 10 °C lower than for roasting in a covered oven dish.

Selecting the cooking duration

Unless otherwise stated, the durations given in the cooking chart are for an oven compartment which has not been pre-heated.



- Determine the cooking duration by multiplying the thickness of the roast [cm] with the time per cm [min./cm] stated below, depending on the type of meat:
 - Beef/Venison: 15–18 min./cm
 - Pork/Veal/Lamb: 12–15 min./cm
 - Sirloin joints/Fillets: 8–10 min./cm
- As a general rule, check whether the food is cooked after the shortest duration.

Notes on the oven functions

You can find an overview of all the functions with their recommended values in “Overview of functions”.

Using Fan Plus

This function is suitable for roasting meat, fish and poultry that needs to be well browned as well as sirloin joints and fillet.

The Fan Plus  function allows you to use a lower temperature than you would with the Conventional Heat  function, because the heat is immediately distributed throughout the oven compartment.

- Place the food on shelf level 1 or 2.

Use the Bottom Heat  function towards the end of the cooking duration to brown the base of the food.

Using Conventional Heat

Use this function for baking traditional recipes. If using an older recipe or cookbook, set the oven temperature 10 °C lower than that recommended. This will not change the cooking duration.

- Place the food on shelf level 1.

Using Eco Fan Heat

Use this function for cooking smaller roasts or meat dishes in an energy-saving way.

- Place the food on shelf level 1.

Grilling

 Risk of injury caused by hot surfaces.

If you grill with the door open, hot air will escape from the oven instead of being cooled by the cooling fan. The control elements will get hot.

Grill with the oven door closed.

Tips for grilling

- Pre-heating is necessary when grilling. Pre-heat the top heat/grill element for approx. 5 minutes with the door closed.
- Trim the meat if necessary. Season meat 10-15 minutes before cooking.
- Add a little oil to lean meat if necessary. Do not use other types of fat as they can easily burn and cause smoke.
- Clean fish in the normal way. To enhance the flavour, season with a little salt. Fish can also be drizzled with lemon juice.
- Use the universal tray with the rack or the grilling and roasting insert (if present) placed on top. The meat juices will collect in the tray under the insert and stop them from burning so that they can be used for making gravy and sauces.

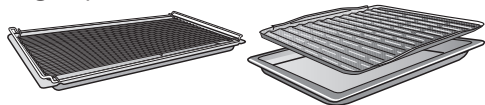

- To grill, brush the rack with oil and then place the food on the rack.

Notes on the cooking charts

You can find the cooking charts at the end of this book.

- Take note of the temperature range, the shelf levels and the timings. These take the size of the meat and cooking practices into account.
- Check the food after the shortest duration quoted.

Selecting the temperature

- As a general rule, select the lower temperature given in the chart. If higher temperatures than those specified are used, the meat will brown on the outside, but will not be properly cooked through.

Choosing a shelf level

- Select the shelf level depending on the thickness of the food to be cooked.
- Place flat food on shelf level 2 or 3.
- Place thicker food on shelf level 1 or 2.

Selecting the cooking duration

- Grill thinner cuts of meat/slices of fish for approx. 6–8 minutes per side. It is best to grill food of a similar thickness at the same time so that the cooking durations do not vary too much.
 - As a general rule, check whether the food is cooked after the shortest duration.
 - To **test the food**, press down on the meat with a spoon. This lets you determine how well the meat has been cooked.
- **Rare**
If the meat gives easily to the pressure of the spoon, it will still be red on the inside.
 - **Medium**
If there is some resistance, the inside will be pink.
 - **Well-done**
If there is great resistance, it is cooked through.

Useful tip: If the surface of a thicker cut of meat is browned but the centre is still raw, move the food to a lower level or reduce the temperature and continue grilling. This will stop the surface from becoming excessively charred.

Notes on the oven functions

You can find an overview of all the functions with their recommended values in “Overview of functions”.

Using Full Grill

Use this function to grill flat thin cuts in large quantities and for browning large baked dishes.

The entire top heat/grill element will get hot and glow red.



Using Fan Grill

This function is suitable for grilling thicker food, such as chicken.



A temperature setting of 220 °C is generally recommended for thinner types of food, while 180–200 °C is recommended for thicker cuts.



Grilling

Fan Grill

- Use the Fan Grill  function for meat, fish, poultry and vegetables.
- Always pre-heat for at least 5 minutes before Fan Grilling.
- It is not necessary to turn food when Fan Grilling. Only one side of the food, however, will become brown.
- The door must be closed when using Fan Grill .
- When using red meat, pat the meat dry before Fan Grilling as this encourages a richer colour.

All temperatures are approximations and must be varied according to the thickness and preparation of the meat. The chart below is a suggested guide only. Personal taste and size of serves will vary times and temperatures. We recommend you monitor cooking results for best outcomes.

Food to be grilled	 [°C]	 ³ ₁	 [min.]
Lean thin sausages	180	3	8–10
Thick sausages	180	3	15–20
Lean beef fillet steak	220	3	6–12
Chicken breast fillet	200	3	14–18
Whole butterflied chicken	200	1	30–35
Thin white fish fillets	220	3	6–10
Thick fish fillets, cutlets or steaks	200	3	10–15
Oily fish	200	3	8–12
Lamb loin chops	190	3	12–16
Lamb back straps	220	3	8–10
Vegetables, capsicum, zucchini, sweet potato, eggplant	200	3	12–15
Potato wedges or small roast potatoes	220	2	20–25
Kebabs and satays (red meat)	200	3	12–15
Chicken satays	200	3	12–15

 Temperature / ³₁ Shelf level /  Duration

Fan Grill  can be used for small roasts but is only recommended for lean, tender cuts of meat, e.g. lamb racks, rump roasts, and beef fillet. Fan Grill the roast at 200 °C on shelf level 3 for approximately 25 minutes, depending on thickness.

Grill

- Use for thick toasts, muffins, cheese on toast, focaccia, bruschetta and bacon.
- Pre-heat grill for at least 5 minutes at 200–220 °C.
- Select the appropriate shelf level for the thickness of the food.
- The door must be closed when using the Grill  function.

This is a suggested guide only. Personal taste and size of serves will vary times and temperatures.

Other applications

This section provides information on the following applications:

- Defrost
- Low temperature cooking
- Bottling
- Drying
- Frozen food/Ready meals
- Heating crockery

Defrost

Gentle defrosting of frozen goods means that the vitamins and minerals are generally retained.

- Select the Fan Plus  function and a temperature of 50 °C.

Air is circulated throughout the oven compartment to gently defrost the frozen food.

 Risk of infection from bacteria. Bacteria such as salmonella can cause life-threatening food poisoning. It is particularly important to observe food hygiene rules when defrosting fish and meat, and in particular when defrosting poultry. Do not use the liquid produced during defrosting. Process the food as required as soon as it has been defrosted.

Useful tips

- Remove the packaging and place the frozen goods on the universal tray or in a suitable bowl or dish.
- Use the universal tray with the rack placed on top of it for defrosting poultry. This way the frozen food will not be lying in the defrosting liquid.
- Meat and poultry need to be fully defrosted before cooking. Fish, on the other hand, can be partially defrosted before cooking. Defrost so that the surface is sufficiently soft to take herbs and seasoning.

Low temperature cooking

Low temperature cooking is ideal for cooking delicate cuts of beef, pork, veal or lamb when a tender result is desired.

First briefly sear the meat all over at a high temperature on the cooktop in order to seal it.

Then place the meat in the pre-heated oven where the low temperature and long cooking duration will cook it to perfection and ensure it is very tender.

The meat will relax. The juices inside will start to circulate evenly throughout the meat to reach the outer layers.

This gives very tender and succulent results.

- Use lean meat which has been correctly hung and trimmed. Bones should be removed before cooking.
- For searing, use a suitable cooking oil or fat that can withstand high temperatures (e.g. clarified butter, vegetable oil).
- Do not cover meat during the cooking process.

The cooking duration takes approx. 2–4 hours depending on the weight and size of the meat and how well you want it cooked.

- As soon as the cooking programme has finished, you can carve the meat straight from the oven. It does not need to rest.
- The meat can be left in the oven compartment to keep warm until you serve it. This will not affect results in any way.

- Serve on pre-heated plates with very hot sauce or gravy to prevent it cooling down too quickly. The meat is at the ideal temperature for eating straight away.

Using Conventional Heat

Refer to the information in the cooking charts at the end of this booklet.

Use the universal tray with the rack placed on top of it.

- Place the rack together with the universal tray on shelf level 1.
- Select the Conventional Heat  function and a temperature of 120 °C.
- Pre-heat the oven together with the universal tray and rack for approx. 15 minutes.
- While the oven is pre-heating, sear the meat on all sides on the cooktop.

 Risk of burning due to hot surfaces!

The oven gets hot during operation. You could burn yourself on the heating elements, the oven compartment, food or accessories. Wear oven gloves when placing food in the oven or removing it, and when adjusting oven shelves etc. in a hot oven.

- Place the seared meat on the oven rack.
- Reduce the temperature to 100 °C (see “Cooking charts”).
- Continue cooking until the end of the programme.

Other applications

Bottling



Risk of infection from bacteria.

The spores of the botulinum bacterium are not sufficiently killed by bottling pulses and meat only once. Toxins may form which can lead to serious poisoning. These spores are only destroyed by reheating the food within 2 days after preserving.

After they have cooled down, **always** reheat pulses and meat a second time within 2 days.



Risk of injury from increased pressure in sealed tins.

Preserving and heating food in sealed tins will result in an increase in pressure, which can cause them to explode.

Do not use tins for preserving or heating food.

Preparing fruit and vegetables

The instructions are for 6–8 jars with a capacity of 1 litre each.

Only use special jars for preserving (preserving jars or jars with a screw cap). Only use undamaged jars and rubber rings.

- Rinse the jars with hot water before bottling and fill them up to a maximum of 2 cm below the rim.
- After you have filled the jars with the produce, clean the glass rims with a clean cloth and hot water and then seal the jars.
- Place the universal tray on shelf level 1 and place the closed jars on the tray.
- Select the Fan Plus  function and a temperature of 160–170 °C.
- Wait until bubbles evenly rise in the jars.



Reduce the temperature in time to prevent the contents from boiling over.

Bottling fruit and gherkins

- Set the specified continued warming temperature as soon as bubbles are visible in the jars, then leave the jars in the warm oven for the time specified.

Bottling vegetables

- As soon as bubbles are visible in the jars, set the specified bottling temperature and cook the vegetables for the time specified.
- After bottling, set the specified continued warming temperature, then leave the jars in the warm oven for the time specified.

		
Fruit	-/-	50 °C 25–35 min.
Gherkins	-/-	50 °C 25–30 min.
Beetroot	120 °C 30–40 min.	50 °C 25–30 min.
Beans (green or yellow)	120 °C 90–120 min.	50 °C 25–30 min.

 Bottling temperature and time once bubbles are visible in the jars

 Continued warming temperature and time

Removing the jars after bottling

 Risk of injury caused by hot surfaces.

The jars are very hot after bottling. Wear oven gloves when removing the jars from the oven.

- Take the jars out of the oven.
- Cover the jars with a towel and leave for approx. 24 hours in a draught-free area.
- After they have cooled down, **always** reheat pulses and meat a second time within 2 days.
- Remove the fasteners from the jars and make sure all jars are closed properly when storing them.

Either boil open jars again or store them in a cool place and consume the preserved fruit or vegetables immediately.

- Check the jars during storage. If jars have opened during storage or if the screw cap is bulging and does not make a popping noise when opened, destroy the contents.

Other applications

Drying

Drying is a traditional method of preserving fruit, certain vegetables and herbs.





It is important that fruit and vegetables are ripe and not bruised before they are dried.

- Prepare the food for drying by cutting it up, and peeling and coring it if necessary.
- Distribute the food for drying evenly in a single layer according to size over the rack or the universal tray.

Useful tip: You can also use the perforated Gourmet baking and AirFry tray, if you have one.

- Dry on a maximum of 2 levels at the same time.
Place the food for drying on shelf levels 1+3.
If using the rack and universal tray, place the universal tray below the rack.
- Select Fan Plus .
- Change the recommended temperature and set the drying time.
- Turn the food for drying on the universal tray at regular intervals.

The drying times are longer for whole or halved dried food.

Food		🌡️ [°C]	🕒 [h]
Fruit		60–70	2–8
Vegetables		55–65	4–12
Mushrooms		45–50	5–10
Herbs*		30–35	4–8

 Function, 🌡️ Temperature, 🕒 Drying time,  Fan Plus,  Conventional Heat

* Dry herbs only on the universal tray on shelf level 2 and use the Conventional Heat  function, as the fan is switched on in the Fan Plus function.

- Reduce the temperature if condensation begins to form in the oven.

Removing the dried food

 Risk of injury caused by hot surfaces.

The oven gets hot during operation. You could burn yourself on the heating elements, the oven compartment, or accessories. Use oven gloves when removing dried food from the oven.

- Allow the dried fruit or vegetables to cool down after drying.

Dried fruit needs to be completely dry, but also soft and elastic. Juice should not escape when cut.

- Store dried food in sealed glass jars or tins.

Frozen food/Ready meals

Tips for cakes, pizza and baguettes

- Bake cakes, pizza and baguettes on baking paper on the rack.
Do not use the baking tray or the universal tray for frozen foods with a large surface area. The tray could become warped and difficult, or even impossible, to remove from the oven compartment when hot. Additional use will make the warping worse.
- Use the lowest temperature recommended on the packaging.

Tips for oven chips, croquettes and similar items

- These frozen items can be cooked on the baking tray or universal tray.
- Use the lowest temperature recommended on the packaging.
- Turn food several times during cooking.

Preparing frozen food/ready meals

Handling food carefully will help protect your health.

Cakes, pizzas and chips should be cooked until golden, not dark brown.

- Select the function and temperature recommended on the manufacturer's packaging.
- Pre-heat the oven.
- Place the food in the pre-heated oven on the shelf level recommended on the packaging.
- Check the food at the end of the shortest cooking duration recommended on the packaging.

Heat crockery

Use the Fan Plus  function for pre-heating crockery.

Only pre-heat heat-resistant dishes.

- Place the rack on shelf level 1 and place the crockery to be pre-heated on it. Depending on the size of the dishes, you can also place them on the oven floor and take out the shelf runners to make more room.
- Select Fan Plus .
- Set the temperature to 50–80 °C.

 Danger of burning!

Wear oven gloves when removing dishes from the oven. Droplets of water may have accumulated underneath the crockery.

- Remove the heated crockery from the oven.

Cleaning and care



Risk of injury caused by hot surfaces.

The oven gets hot during operation. You could burn yourself on the heating elements, the oven compartment, or accessories.

Allow the heating elements, oven compartment and the accessories to cool before manual cleaning.



Risk of injury due to electric shock.

The steam from a steam cleaning appliance could reach electrical components and cause a short circuit.

Never use a steam cleaner for cleaning the oven.

The use of unsuitable cleaning agents can cause the surfaces to discolour or alter. The oven front is particularly susceptible to damage from oven cleaners or descaling agents.

All surfaces of this appliance are susceptible to scratching. Scratches on glass surfaces could cause a breakage in certain circumstances. Remove all cleaning agent residues immediately.

Unsuitable cleaning agents

To avoid damaging the surfaces of your appliance, do not use:

- cleaning agents containing soda, alkalines, ammonia, acids or chlorides
- cleaning agents containing descaling agents on the front
- abrasive cleaning agents, e.g. powder cleaners and cream cleaners
- solvent-based cleaning agents
- stainless steel cleaning agents
- dishwasher cleaners
- glass cleaning agents
- cleaning agents for ceramic cooktops
- hard, abrasive brushes or sponges, e.g. pot scourers, brushes or sponges which have been previously used with abrasive cleaning agents
- dirt eraser sponges
- sharp metal scrapers
- steel wool or metal scourers
- spot cleaning with mechanical cleaning agents
- oven cleaner
- stainless-steel spiral pads

If soiling is left on for any length of time, it may become impossible to remove. Continued use without regular cleaning will make the oven much harder to clean. Failure to maintain the oven in a clean condition could lead to deterioration of the surfaces that could adversely affect the life of the appliance and result in a hazardous situation. Remove any soiling immediately.

The accessories are not dishwasher-safe.

Useful tip: Soiling caused by spilled fruit juices and cake mixtures is best removed while the oven is still warm. Exercise caution and make sure the oven is not too hot.

To make it easier to clean the oven:

- Remove the door.
- You can remove the shelf runners together with the FlexiClip telescopic runners (if present).
- Remove the catalytic enamelled back panel.
- Lower the top heat/grill element.

Removing normal soiling

The fibreglass seal around the front of the oven should be handled carefully. Do not rub and scour it. Ideally, you should avoid cleaning it.

Removing normal soiling

- It is best to remove normal soiling immediately using a clean sponge and a solution of hot water and washing-up liquid, or a clean, damp microfibre cloth.
- Remove any residual cleaning agent thoroughly with clean water. This is particularly important for any parts with a PerfectClean finish, as cleaning agent residues will impair the non-stick properties.
- After cleaning, wipe the surfaces dry using a soft cloth.

Removing stubborn soiling (excluding the FlexiClip telescopic runners)

Spilled fruit and roasting juices may cause lasting discolouration or matt patches on surfaces. This discolouration will not affect the functional characteristics of the surface finish.

Do not attempt to remove these marks. Clean them following the instructions given here.

- Baked-on deposits can be removed with a glass scraper or with a stainless steel spiral pad, hot water and washing-up liquid.

Exposure to scouring agents, abrasive brushes or sponges and oven sprays can cause catalytic enamel to lose its self-cleaning properties.

Remove the catalytic enamelled panels before using an oven cleaner.

Cleaning and care

Using oven cleaners

- Very stubborn soiling on PerfectClean surfaces can be cleaned using Miele Oven Cleaner. This cleaner must only be applied to cold surfaces.

If the oven spray gets into gaps and openings, a strong odour is generated during subsequent cooking programmes.

Do not spray the oven cleaner onto the roof of the oven compartment.

Do not spray the oven cleaner into the gaps and openings of the oven compartment walls and rear wall.

- Follow the instructions on the packaging.

Oven cleaners from other manufacturers must only be used in a cold oven and must not be left on for longer than 10 minutes.

- If necessary, the scouring pad on the back of a non-scratching washing-up sponge can be used to remove the soiling after the soaking time.
- Remove any residual cleaning agent thoroughly with clean water.
- Dry all surfaces with a soft cloth.

Stubborn soiling on the FlexiClip telescopic runners

Do not clean FlexiClip telescopic runners in a dishwasher. The special lubricant used in the telescopic runners will wash out during dishwashing.

This will affect their smooth functioning.

For stubborn surface soiling or if the bearings become sticky, proceed as follows:

- Soak the FlexiClip telescopic runners briefly (approx. 10 minutes) in a solution of hot water and dishwashing liquid.

If necessary, the scouring pad on the back of a non-scratching dishwashing sponge can be used to remove the soiling. You can clean the bearings with a soft brush.

The runners may appear discoloured or a lighter colour in places after they have been cleaned. This will not affect the functioning of the runners in any way.

Cleaning the catalytic enamelled back panel

Catalytic enamel is self-cleaning, which means that soiling from oil and fat is burnt off automatically when very high temperatures are reached inside the oven. You do not need to use any additional cleaning agent. The higher the temperature, the more effective the process.

Exposure to scouring agents, abrasive brushes or sponges and oven sprays can cause catalytic enamel to lose its self-cleaning properties.
Remove the catalytic enamelled panels before using an oven cleaner in the oven compartment.

Removing soiling caused by spices, sugar and similar deposits

- Remove the back panel (see “Cleaning and care – Removing the back panel”).
- Clean the back panel by hand with a solution of hot water and washing-up liquid applied with a soft brush.
- Rinse the back panel thoroughly.
- Let the back panel dry before placing it back in the oven.

Removing oil and grease soiling

- Remove all accessories from the oven, including the shelf runners.
- Wipe large deposits of soiling from the inside of the door and the PerfectClean enamelled surfaces before starting the catalytic cleaning process to avoid them baking on.
- Select the Fan Plus  function and 250 °C.
- Then heat the empty oven for at least 1 hour.

The length of time required will depend on the degree of soiling.

If the catalytic enamel is very heavily soiled with oil and grease, a film can form on the surfaces of the oven interior during the cleaning process.

 Risk of injury caused by hot surfaces.

The oven gets hot during operation. You could burn yourself on the heating elements and the oven interior.

Allow the heating elements and oven compartment to cool before manual cleaning.

- Clean the inside of the door and the oven compartment with a solution of hot water and washing-up liquid, applied with a clean sponge, or a clean, damp microfibre cloth.

Any remaining soiling will gradually disappear with each subsequent use of the oven at high temperatures.

Cleaning and care

Removing the door

The door weighs approx. 11 kg.

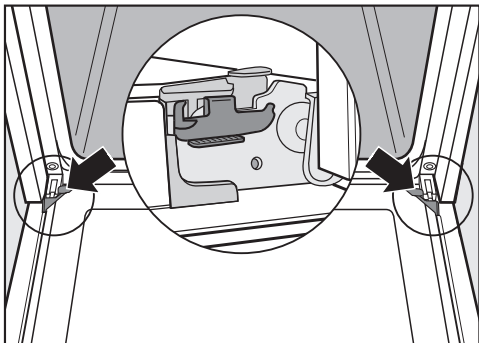

The oven door is connected to the hinges by retainers. Before removing the door from the retainers, the locking clamps on both hinges have to be released.

- Open the door fully.

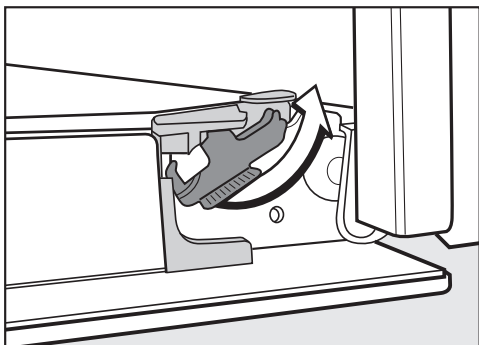

- Release the locking clamps by turning them as far as they will go.

The oven can be damaged if you remove the door incorrectly.

Do not pull the door horizontally off its retainers, as they will spring back against the oven.

Do not pull the door off the retainers by the handle, as the handle could break off.

- Raise the door up till it rests partially open.



- Hold the door on either side and pull it diagonally upwards from the hinge guides. Make sure that the door is straight.

Fitting the door

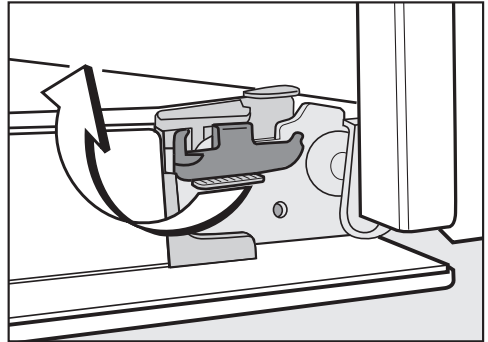
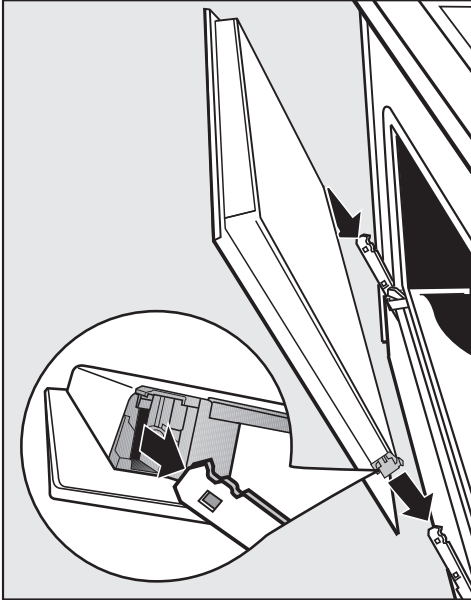

- To relock the locking clamps, flip them back up into a horizontal position as far as they will go.

- Hold the door securely on both sides and carefully fit it back onto the hinge retainers. Make sure that the door goes back on straight.
- Open the door fully.

If the locking clamps are not locked, the door could work loose resulting in damage.

Ensure that the locking clamps are locked after refitting the door.

Cleaning and care

Removing the shelf runners with FlexiClip telescopic runners

You can remove the shelf runners together with the FlexiClip telescopic runners (if present).

If you wish to remove the FlexiClip telescopic runners separately beforehand, please follow the instructions in “Features – Fitting and removing the FlexiClip telescopic runners”.

 Risk of injury caused by hot surfaces.

The oven gets hot during operation. You could burn yourself on the heating elements, the oven compartment, or accessories.

Allow the heating elements, oven compartment and the accessories to cool before removing the shelf runners.

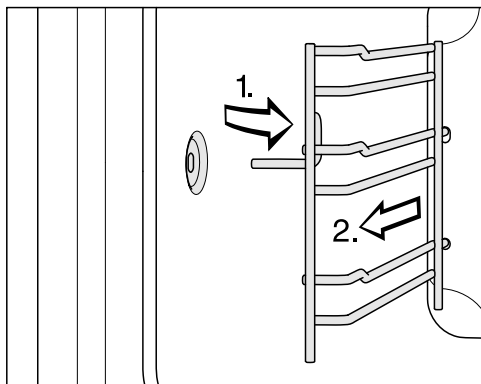

- Pull the shelf runners out of the holder (1) at the front of the oven and then pull them out of the oven (2).

Refit in the reverse order.

- Ensure that all parts are correctly fitted.

Lowering the top heat/grill element

If the oven compartment roof is badly soiled, the top heat/grill element can be lowered to make cleaning easier. Clean the oven compartment roof regularly with a damp cloth or a dishwashing sponge.

 Risk of injury caused by hot surfaces.

The oven gets hot during operation. You could burn yourself on the heating elements, the oven compartment, or accessories.

Allow the heating elements, oven compartment and the accessories to cool before manual cleaning.

The enamel on the oven floor can be damaged by fastening nuts being dropped on it.

Place a cloth or similar item over the oven floor to protect it.

- Remove the shelf runners.

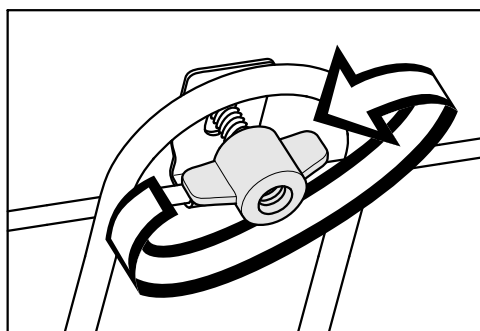

- Unscrew the wing nuts.

Use caution not to damage the top heat/grill element.
Do not use force to lower the top heat/grill element as this can cause it to break.

- Carefully lower the top heat/grill element.

You can now access the ceiling of the oven compartment.

- Clean the ceiling of the oven compartment with a clean sponge and a solution of hot water and washing-up liquid or a clean, damp microfibre cloth.
- After cleaning, raise the top heat/grill element gently back up again.
- Replace the wing nuts and tighten them securely.
- Refit the shelf runners.

Removing the back panel

The back panel can be removed for cleaning purposes.

 Risk of injury caused by hot surfaces.

The oven gets hot during operation. You could burn yourself on the heating elements, the oven compartment, or accessories. Allow the heating element, oven compartment and the accessories to cool before removing the back panel.

 Risk of injury caused by the rotating fan impeller.

You could injure yourself on the impeller of the hot air fan. Never put the oven into operation without the back panel in place.

- Disconnect the appliance from the electricity supply. Switch off at the wall and withdraw the plug from the socket, or switch off at the mains circuit breaker.
- Remove the shelf runners.
- Undo the four screws in the corners of the back panel and take it out.
- Clean the back panel (see “Cleaning and care - Cleaning the catalytic enamelled back panel”).

Refit in the reverse order.

- Refit the back panel carefully.

Make sure the openings are located as illustrated in “Overview”.

- Refit the shelf runners.
- Reconnect the oven to the electricity supply.



Problem solving guide

Many malfunctions and minor faults that can occur in daily operation can be corrected without contacting Miele. This will save you time and money because you will not need a service call.

You can find information on how to remedy faults yourself at www.miele.com.au/service or www.miele.co.nz/service and on the Miele website. Please note, however, that a call-out charge will be applied to unnecessary service visits where the problem could have been rectified as described in these operating instructions.

Problem	Possible cause and remedy
The display is dark.	<p>There is no power to the oven.</p> <ul style="list-style-type: none"> ■ Check that the oven plug is correctly inserted into the socket and switched on. ■ Check if the circuit breaker has tripped. Contact a qualified electrician or Miele.
The oven does not heat up.	<p>You have only selected an oven function or a temperature.</p> <ul style="list-style-type: none"> ■ Select both a function and a temperature.
	<p>The system lock  has been switched on.</p> <ul style="list-style-type: none"> ■ Switch off the system lock (see “Clock/timer - Changing settings”).
	<p>There is no power to the oven.</p> <ul style="list-style-type: none"> ■ Check whether the mains fuse has tripped. If it has, contact a qualified electrician or Miele.
12:00 is flashing in the display.	<p>There has been a power cut.</p> <ul style="list-style-type: none"> ■ Reset the time of day (see “Using for the first time”). Cooking times will also need to be reset.
The signal tone does not sound.	<p>Signal tones are switched off.</p> <ul style="list-style-type: none"> ■ Switch on the signal tones (see “Clock/Timer - Changing settings”).
A noise can be heard after a cooking process.	<p>The cooling fan will continue to run for a while after the oven has been switched off to prevent any humidity building up in the oven, on the control panel or in the oven housing unit. The cooling fan will switch itself off automatically after a certain period of time.</p>
Cakes and biscuits are not cooked properly after the duration given in the cooking chart.	<p>A different temperature from the one given in the recipe has been used.</p> <ul style="list-style-type: none"> ■ Select the temperature required for the recipe.
	<p>The ingredient quantities used are different from those given in the recipe.</p> <ul style="list-style-type: none"> ■ Check whether you have amended the recipe. The addition of more liquid or more eggs makes a moister mix which would take longer to cook.

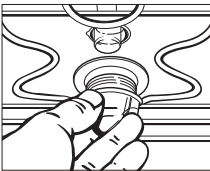
Problem solving guide

Problem	Possible cause and remedy
<p>The browning of baked goods is uneven.</p>	<p>The wrong temperature or shelf level was selected.</p> <ul style="list-style-type: none"> ■ There will always be a slight unevenness in browning. If browning is very uneven, check whether the correct temperature and shelf level were selected. <p>The material or colour of the baking tin is not suitable for the oven function.</p> <ul style="list-style-type: none"> ■ When using the Conventional Heat  function, light coloured, shiny tins are not as suitable. Dark, matt tins are best for baking.
<p>Rust-like spots appear on catalytic surfaces.</p>	<p>The catalytic cleaning process does not remove spices, sugar and similar deposits.</p> <ul style="list-style-type: none"> ■ Take the catalytic panels out of the oven and remove this type of soiling with a mild solution of hot water and washing-up liquid applied with a soft brush (see “Cleaning and care – Cleaning the catalytic enamelled back panel”).
<p>The FlexiClip telescopic runners do not push in or pull out smoothly.</p>	<p>The bearings in the FlexiClip telescopic runners are not sufficiently lubricated.</p> <ul style="list-style-type: none"> ■ Lubricate the bearings with the special Miele lubricant. Only the special Miele lubricant is designed to withstand the high temperatures in the oven compartment. Other lubricants may harden and stick to the FlexiClip telescopic runners when they are heated. You can obtain the special Miele lubricant from Miele.
<p>The top oven lighting does not switch on.</p> 	<p>The halogen lamp is faulty and needs replacing.</p> <div style="border: 1px solid gray; padding: 5px; margin-bottom: 10px;"> <p> Danger of burning! Make sure the oven heating elements are switched off. Make sure the oven compartment has cooled down.</p> </div> <ul style="list-style-type: none"> ■ Disconnect the appliance from the mains. Switch off at the wall and withdraw the plug from the socket, or switch off at the mains circuit breaker. ■ Turn the lamp cover a quarter turn anti-clockwise to release it and then pull it together with its seal downwards to take it out. ■ Replace the halogen lamp (Osram 66725 AM/A, 230 V, 25 W, G9). ■ Refit the lamp cover together with its seal and turn clockwise to secure. ■ Reconnect the oven to the electricity supply. <p>You have selected the Eco Fan Heat  function. The oven lighting does not switch on with this function.</p>

Service

You can find information on how to remedy faults yourself and about Miele spare parts at www.miele.com.au/service or www.miele.co.nz/service.

Contact in case of fault

In the event of any faults which you cannot remedy yourself, please contact Miele.

You can book a Miele customer service call-out online at www.miele.com.au/service or www.miele.co.nz/service.

Contact information for Miele can be found at the end of this booklet.

Please quote the model and serial number of your appliance when contacting Miele. This information can be found on the data plate.

This information is given on the data plate, visible on the front frame of the oven, with the door fully open.

Warranty

The manufacturer's warranty for this appliance is 2 years.

For further information, please refer to your warranty booklet.

Building-in dimensions

Dimensions are given in mm.

Installation in a tall or base unit

When building the oven into a base unit underneath a cooktop, please also observe the installation instructions for the cooktop as well as the building-in height required for the cooktop.

The HAL 90 trim, available as an optional accessory, is only required when building the oven into a base unit.

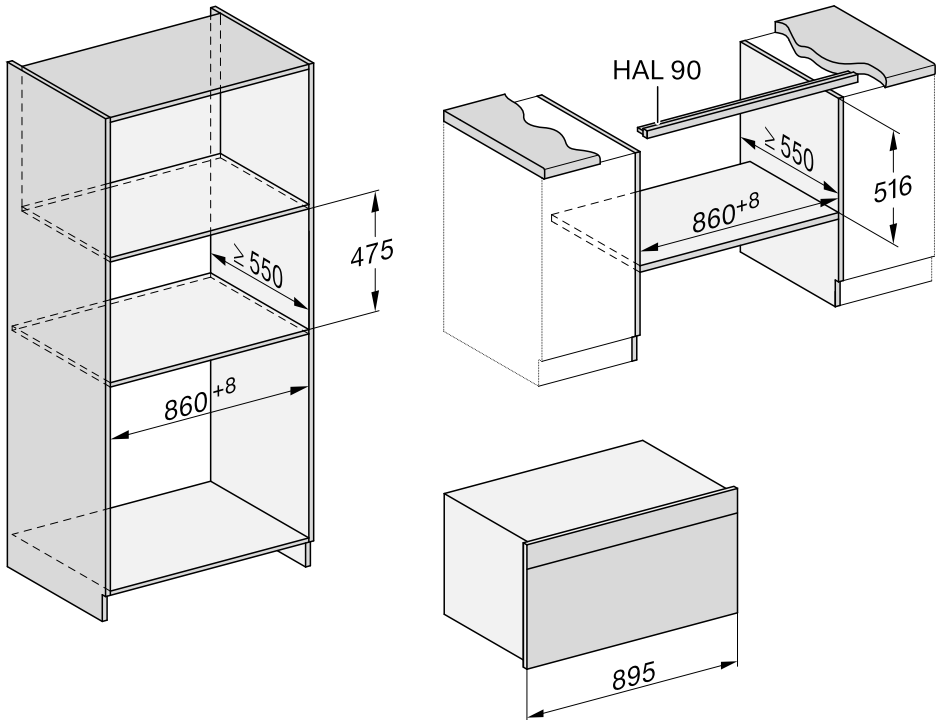

Installation

Tall unit side view

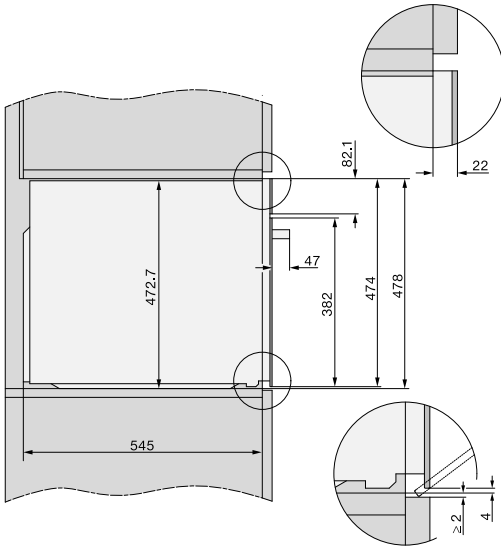

Base unit side view

The HAL 90 trim is available as an optional accessory.

- Fix the HAL trim into the unit cut-out under the worktop.

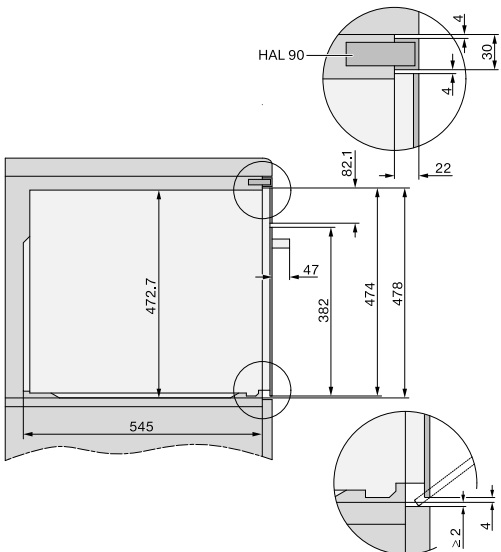

Connections and ventilation

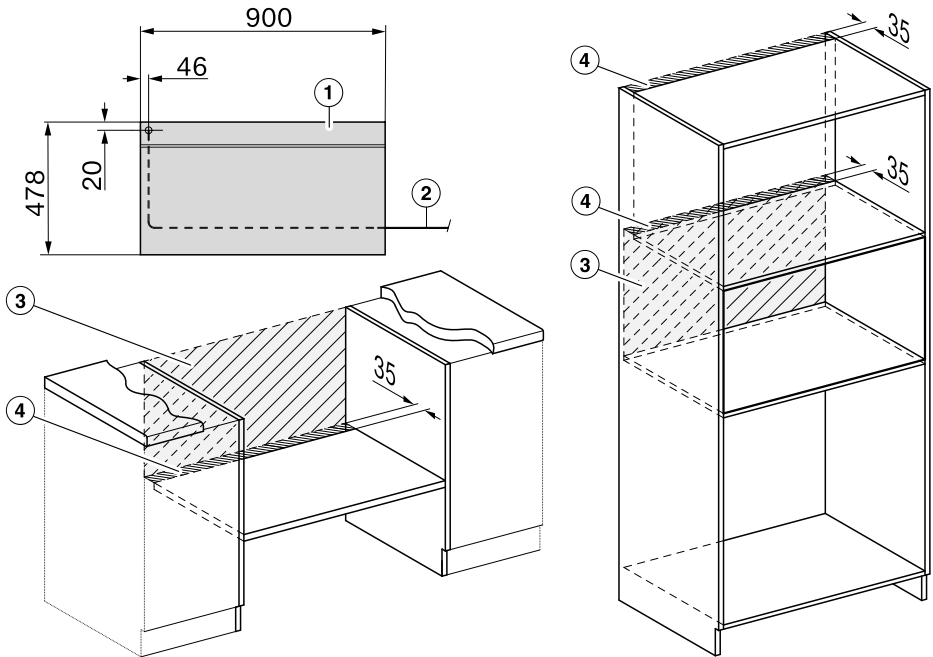

- ① Front view
- ② Mains connection cable, length = 2,000 mm
- ③ No connections permitted in this area
- ④ Ventilation cut-out, min. 150 cm²

Installation

Installing the oven

For safety reasons, the oven may only be used after it has been fully installed.

The oven requires a sufficient supply of cool air for efficient operation. The required supply of cool air must not be excessively heated by other heat sources (e.g. solid fuel stoves).

The following must be observed when installing the appliance:
Make sure that the shelf that the oven sits on does not touch the wall.
Do not fit heat insulation strips to the side walls of the housing unit.

- Connect the mains cable from the oven to the electricity supply.

Do not carry the oven by the door handle. The door can be damaged.
Use the handle cut-outs on the side of the housing to lift the appliance.

It is a good idea to remove the door (see "Cleaning and care - Removing the door") and the accessories before installing the appliance. This makes the oven lighter when you push it into the housing unit and you do not run the risk of lifting it by the door handle by mistake.

- Remove the carry handles.
- Push the oven into the housing unit and align it.
- Open the door, if you have not removed it.

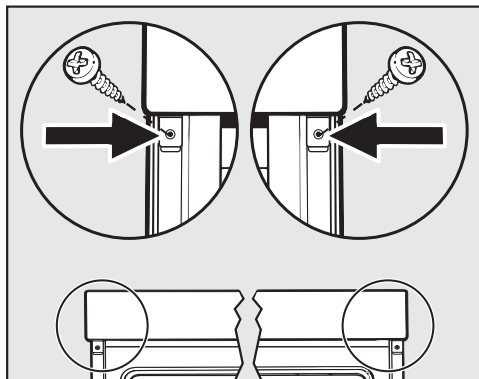

- Use the screws supplied to secure the oven to the side walls of the housing unit.
- Refit the door, if necessary (see "Cleaning and care - Fitting the door").

Electrical connection

⚠ Danger of injury!
Miele cannot be held liable for unauthorised installation, maintenance and repair work as this can be dangerous to users.

Connection to the electrical mains may only be carried out by a qualified electrician in accordance with national and local regulations and the additional regulations of the local electrical supply companies.

Connection of this appliance must comply with national and local safety regulations.

Connection to a switched socket is recommended as this provides easier access in the case of a service call.

If the appliance is **hardwired** or if the switch is not accessible after installation, an additional means of disconnection must be provided for all poles.

Suitable means of disconnection include switches with an all-pole contact gap of at least 3 mm. These include isolator switches, fuses and relays in accordance with the wiring rules AS/NZS 3000.

Voltage, rated load and fuse rating are given on the data plate situated at the front of the oven compartment. Please ensure the connection data matches the household supply.

When contacting Miele, please quote the following:

- Model number
- Serial number
- Connection data (voltage/frequency/maximum rated load)

If the mains connection cable is damaged, it must be replaced by a suitably qualified electrician with a specialist connection cable of type H 05 VV-F, available from Miele, in order to avoid a hazard.

Temporary or permanent operation with a self-sufficient or non-mains synchronous energy supply system (e.g. isolated networks, back-up systems) is possible. A requirement for the operation is that the energy supply system complies with all current local and national requirements that apply to stand-alone, solar and/or battery systems.

The protective measures provided in the domestic installation and in this Miele product must also be assured in their function and operation in isolated

operation or in non-mains synchronous operation, or replaced with equivalent measures in the installation.

Oven

This oven is supplied with an approx. 2 m long 3-core cable for connection to a single-phase supply.





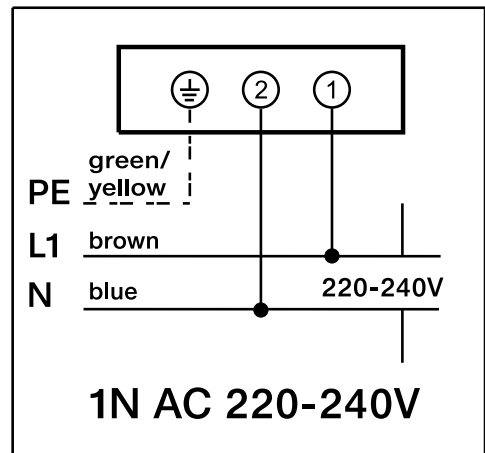















Maximum rated load: see data plate.







Wiring diagram



Cooking charts

Creamed mixture

Cakes/ Biscuits		 [°C]	 ³ 1	 [min.]
Muffins (1 tray)		150–160	2	25–35
Muffins (2 trays)		150–160	1+3	30–40 ³
Small cakes (1 tray)		150	1	25–35
		160 ²	2	15–25
Small cakes (2 trays)		140 ²	1+3	30–40
Sand cake (rack, loaf tin, 30 cm) ¹		150–160	2	65–75
		150–160 ²	2	65–75
Marble, nut cake (rack, loaf tin, 30 cm) ¹		150–160	1	55–65
		150–160	1	60–70
Marble, nut cake (rack, ring tin/Bundt cake tin, Ø 26 cm) ¹		150–160	1	55–65
		150–160	1	60–70
Fresh fruit cake (1 tray)		150–160	1	45–55
		150–160	1	50–60
Fresh fruit cake (rack, springform cake tin, Ø 26 cm) ¹		150–160	1	55–65
		170–180 ²	1	50–60
Flan base (rack, flan base tin, Ø 28 cm) ¹		150–160	1	25–35
		170–180 ²	1	15–25





















 Function,  Temperature, ³ Shelf level,  Cooking duration,  Fan Plus,  Conventional Heat







¹ Use a dark coloured, matte baking tin and place it centrally on the rack.

² Pre-heat the oven before placing the food inside. Do not use the Booster  function for this purpose.

³ Take the baking trays out of the oven early if the food has already browned sufficiently before the specified cooking time has elapsed.

Rubbed in mixture

Cakes/biscuits (accessories)		 [°C]	 ³	 [min.]
Cookies (1 tray)		140–150	1	20–30
		150–160	2	25–35
Cookies (2 trays)		140–150	1+3	20–30 ³
Drop cookies (1 tray)		140	1	30–40
		160 ²	2	20–30
Drop cookies (2 trays)		140	1+3	35–45 ³
Flan base (rack, flan base tin, Ø 28 cm) ¹		150–160	1	35–45
		170–180 ²	2	20–30
Cheesecake (rack, springform cake tin, Ø 26 cm) ¹		150–160	1	95–105
Apple pie (rack, springform cake tin, Ø 20 cm) ¹		160	1	85–95
		170	1	95–105
Apple pie (rack, springform cake tin, Ø 26 cm) ¹		170–180 ²	1	50–60
Fresh fruit cake, glazed (rack, springform cake tin, Ø 26 cm) ¹		170–180	1	50–60
Fruit flan (1 tray)		170–180	2	60–70
Swiss fruit tart (tray)		210–220 ²	1	30–40
Scones (2 x aluminium tray on rack, 4 x 4 pieces on each tray)		180–190 ²	1+3	15–20 ³

 Function,  Temperature, ³ Shelf level,  Cooking duration,  Fan Plus,  Eco Fan Heat,  Conventional Heat





















¹ Use a dark coloured, matte baking tin and place it centrally on the rack.





² Pre-heat the oven before placing the food inside. Do not use the Booster  function for this purpose.

³ Take the baking trays out of the oven early if the food has already browned sufficiently before the specified cooking time has elapsed.

Cooking charts



Yeast dough







Cakes/biscuits (accessories)		 [°C]	 ³ ₁	 [min.]
Bundt cake (rack, Bundt cake tin, Ø 24 cm) ¹		150–160	1	45–55
		160–170	1	50–60
Stollen (1 tray)		150–160	1	50–60
		160–170	1	45–55
Streusel cake with/without fruit (1 tray)		160–170	2	50–60
		170–180	2	40–50
Fresh fruit cake (1 tray)		160–170	2	40–50
		170–180	2	40–50
Apple turnovers/raisin scrolls (1 tray)		160–170	2	25–35
Apple turnovers/raisin scrolls (2 trays)		160–170	1+3	30–40 ⁴
White bread, free form (1 tray)		190–200	1	30–40
		190–200	1	30–40
White bread (rack, loaf tin, 30 cm) ¹		180–190	1	45–55
		190–200 ²	1	55–65
Wholegrain bread (loaf tin, 30 cm)		180–190	1	55–65
		200–210 ²	1	55–65
Prove yeast dough (rack)		50	– ³	–

 Function,  Temperature, ³₁ Shelf level,  Cooking duration,  Fan Plus,  Conventional Heat

- ¹ Use a dark coloured, matte baking tin and place it centrally on the rack.
- ² Pre-heat the oven before placing the food inside. Do not use the  Booster function for this purpose.
- ³ Place the rack on the floor of the oven, and stand the bowl with the dough on the rack. Depending on the size of the dish, you may need to remove the shelf runners.
- ⁴ Take the baking trays out of the oven early if the food has already browned sufficiently before the specified cooking time has elapsed.









Quark dough







Cakes/biscuits (accessories)		 [°C]	 ³ ₁	 [min.]
Fresh fruit cake (1 tray)		160–170	2	40–50
		170–180	2	40–50
Apple turnovers/raisin scrolls (1 tray)		160–170	2	25–35
Apple turnovers/raisin scrolls (2 trays)		150–160	1+3	25–35 ¹

 Function,  Temperature,  ³₁ Shelf level,  Cooking duration,  Fan Plus,  Conventional Heat

¹ Take the baking trays out of the oven early if the food has already browned sufficiently before the specified cooking time has elapsed.

Sponge mixture

Cakes/biscuits (accessories)		 [°C]	 ³ ₁	 [min.]
Sponge cake base (2 eggs) (rack, springform cake tin, Ø 26 cm) ¹		160–170 ²	1	20–30
Sponge cake base (4–6 eggs) (rack, springform cake tin, Ø 26 cm) ¹		150–160 ²	1	35–45
Whisked sponge (rack, springform cake tin, Ø 26 cm) ¹		170	1	20–30
		150–170 ²	1	20–45
Sponge cake base (1 tray)		160–170 ²	2	10–20











 Function,  Temperature,  ³₁ Shelf level,  Cooking duration,  Fan Plus,  Conventional Heat





¹ Use a dark coloured, matte baking tin and place it centrally on the rack.

² Pre-heat the oven before placing the food inside. Do not use the Booster  function for this purpose.

Cooking charts





















Choux pastry, puff pastry, meringue









Cakes/biscuits (accessories)		 [°C]	 ³ ₁	 [min.]
Choux buns (1 tray)		160–170	1	30–40
Pastry puffs (1 tray)		170–180	2	20–30
Pastry puffs (2 trays)		170–180	1+3	20–30 ¹
Macaroons (1 tray)		120–130	2	25–50
Macaroons (2 trays)		120–130	1+3	25–50 ¹
Meringues/pavlovas (1 tray of 6, each Ø 6 cm)		90–100	2	120–150
Meringues/pavlovas (2 trays of 6, each Ø 6 cm)		90–100	1+3	150–180



 Function,  Temperature,  ³₁ Shelf level,  Cooking duration,  Fan Plus

¹ Take the baking trays out of the oven early if the food has already browned sufficiently before the specified cooking time has elapsed.

Savoury snacks



















Food (accessories)		 [°C]	 ³ ₁	 [min.]
Savoury flan (1 tray)		220–230 ¹	1	25–35
Onion tart (1 tray)		180–190 ¹	2	25–35
Pizza, yeast dough (1 tray)		170–180	2	30–40
		210–220 ¹	2	30–40
Pizza, yeast dough (1 aluminium Pizza dish Ø 35 cm on rack)		200 ¹	1	14–16
Pizza, quark dough (1 tray)		170–180	2	30–40
		190–200 ¹	2	25–35
Frozen pizza, pre-cooked (rack)		200–210	2	20–25
Toast (rack)		 ²	2	5–8
Baked dishes/gratins (e.g. toast) (rack on universal tray)		 ²	2	3–6
Grilled vegetables (rack on universal tray)		 ²	3	5–10 ³
		 ²	2	5–10 ³
Ratatouille (1 universal tray)		180–190	2	55–65

 Function,  Temperature,  ³₁ Shelf level,  Cooking duration,  Conventional Heat,  Fan Plus,  Eco Fan Heat,  Full Grill,  Fan Grill



- ¹ Pre-heat the oven before placing the food inside. Do not use the Booster  function for this purpose.
- ² Pre-heat the oven for 5 minutes before placing the food inside. Do not use the Booster  function for this purpose.
- ³ If possible, turn the food halfway through the cooking duration.

Cooking charts















Beef







Food (accessories)		 [°C]	 ³	 [min.]	 ⁹ [°C]
Braised beef, approx. 1 kg (oven dish with lid)	 ²	150–160 ³	1	120–130 ⁶	–
	 ²	170–180 ³	1	120–130 ⁶	–
	 ²	170–180	1	160–180 ⁷	–
Fillet of beef, approx. 1 kg (universal tray)	 ²	180–190 ³	1	25–60	53–75
Fillet of beef, “rare”, approx. 1 kg ¹	 ²	80–85 ⁴	1	70–80	53–55
Fillet of beef, “medium”, approx. 1 kg ¹	 ²	90–95 ⁴	1	80–90	60–65
Fillet of beef, “well-done”, approx. 1 kg ¹	 ²	95–100 ⁴	1	110–130	70–75
Sirloin joint, approx. 1 kg (universal tray)	 ²	180–190 ³	1	35–65	53–75
Sirloin joint, “rare”, approx. 1 kg ¹	 ²	80–85 ⁴	1	80–90	53–55
Sirloin joint, “medium”, approx. 1 kg ¹	 ²	90–95 ⁴	1	110–120	60–65
Sirloin joint, “well-done”, approx. 1 kg ¹	 ²	95–100 ⁴	1	130–140	70–75
Burger, rissoles (rack on shelf level 3 and universal tray on shelf level 1)	 ²	 ⁵	3	15–30 ⁸	–

 Function,  Temperature, ³ Shelf level  Cooking duration, ⁹ Core temperature,  Fan Plus,  Conventional Heat,  Eco Fan Heat,  Full Grill

- ¹ Use the rack and the universal tray.
- ² Sear the meat on the cooktop first.
- ³ Pre-heat the oven before placing the food inside. Do not use the Booster  function for this purpose.
- ⁴ Pre-heat the oven at 120 °C for 15 minutes. Reduce the temperature when you place the food in the oven.
- ⁵ Pre-heat the oven for 5 minutes before placing the food inside. Do not use the Booster  function for this purpose.
- ⁶ Roast with the lid on first. Remove the lid after roasting for 90 minutes and add approx. 0.5 litres of liquid.
- ⁷ Roast with the lid on first. Remove the lid after roasting for 100 minutes and add approx. 0.5 litres of liquid.
- ⁸ If possible, turn the food halfway through the cooking duration.
- ⁹ If you have a separate food probe you can use the core temperature shown.

Veal



















Food (accessories)		 [°C]	 ³ ₁	 [min.]	 ⁶ [°C]
Braised veal, approx. 1.5 kg (oven dish with lid)	 ²	160–170	1	120–130 ⁵	–
	 ²	170–180	1	120–130 ⁵	–
Fillet of veal, approx. 1 kg (universal tray)	 ²	160–170 ³	1	30–60	53–75
Fillet of veal, “rare”, approx. 1 kg ¹	 ²	80–85 ⁴	1	50–60	53–55
Fillet of veal, “medium”, approx. 1 kg ¹	 ²	90–95 ⁴	1	80–90	60–65
Fillet of veal, “well-done”, approx. 1 kg ¹	 ²	95–100 ⁴	1	90–100	70–75
Saddle of veal, “rare”, approx. 1 kg ¹	 ²	80–85 ⁴	1	80–90	53–55
Saddle of veal, “medium”, approx. 1 kg ¹	 ²	90–95 ⁴	1	100–130	60–65
Saddle of veal, “well-done”, approx. 1 kg ¹	 ²	95–100 ⁴	1	130–140	70–75

 Function,  Temperature, ³₁ Shelf level,  Cooking duration, ⁶ Core temperature,  Fan Plus,  Conventional Heat

- ¹ Use the rack and the universal tray.
- ² Sear the meat on the cooktop first.
- ³ Pre-heat the oven before placing the food inside. Do not use the Booster  function for this purpose.
- ⁴ Pre-heat the oven at 120 °C for 15 minutes. Reduce the temperature when you place the food in the oven.
- ⁵ Roast with the lid on first. Remove the lid after roasting for 90 minutes and add approx. 0.5 litres of liquid.
- ⁶ If you have a separate food probe you can use the core temperature shown.

Cooking charts











Pork







Food (accessories)		 [°C]	 ³ ₁	 [min.]	 ⁹ [°C]
Pork joint/pork neck roast, approx. 1 kg (oven dish with lid)		160–170	1	130–140 ⁵	80–90
		180–190	1	140–150 ⁵	80–90
Pork joint with crackling, approx. 2 kg (oven dish)		180–190	1	140–150 ⁶	80–90
		190–200	1	130–150 ⁶	80–90
Fillet of pork, approx. 350 g ¹	 ²	90–100 ³	1	70–90	60–75
Ham roast, approx. 1.5 kg (oven dish with lid)		160–170	1	130–160 ⁷	80–90
Gammon joint, approx. 1 kg (universal tray)		150–160	1	50–60	75–80
Gammon joint, approx. 1 kg ¹	 ²	95–105 ³	1	140–160	75–80
Meat loaf, approx. 1 kg (universal tray)		170–180	1	60–70 ⁶	80–85
		190–200	1	70–80 ⁶	80–85
Bacon ¹		275 ⁴	3	3–5	–
Sausage ¹		 ⁴	3	8–15 ⁸	–

 Function,  Temperature, ³₁ Shelf level  Cooking duration, ⁹ Core temperature,  Fan Plus,  Conventional Heat,  Eco Fan Heat,  Full Grill

- ¹ Use the rack and the universal tray.
- ² Sear the meat on the cooktop first.
- ³ Pre-heat the oven at 120 °C for 15 minutes. Reduce the temperature when you place the food in the oven.
- ⁴ Pre-heat the oven for 5 minutes before placing the food inside. Do not use the Booster  function for this purpose.
- ⁵ Roast with the lid on first. Remove the lid after roasting for 60 minutes and add approx. 0.5 litres of liquid.
- ⁶ Add approx. 0.5 l of liquid halfway through roasting.
- ⁷ Roast with the lid on first. Remove the lid after roasting for 100 minutes and add approx. 0.5 litres of liquid.
- ⁸ If possible, turn the food halfway through the cooking duration.
- ⁹ If you have a separate food probe you can use the core temperature shown.

Lamb, game















Food (accessories)		 [°C]	 ³ ₁	 [min.]	 ⁵ [°C]
Leg of lamb on the bone, approx. 1.5 kg (oven dish with lid)		170–180	1	100–120 ⁴	53–75
Saddle of lamb, off the bone (universal tray)	 ¹	180–190 ²	1	10–20	53–75
Saddle of lamb, off the bone (rack and universal tray)	 ¹	95–105 ³	1	40–60	53–75
Saddle of venison, off the bone (universal tray)	 ¹	160–170 ²	1	70–90	54–57
Roebuck saddle, off the bone (universal tray)	 ¹	140–150 ²	1	25–35	60–81
Leg of wild boar, off the bone, approx. 1 kg (oven dish with lid)	 ¹	170–180	1	100–120 ⁴	80–90









 Function,  Temperature, ³₁ Shelf level,  Cooking duration, ⁵ Core temperature,  Conventional Heat

- ¹ Sear the meat on the cooktop first.
- ² Pre-heat the oven before placing the food inside. Do not use the Booster  function for this purpose.
- ³ Pre-heat the oven at 120 °C for 15 minutes. Reduce the temperature when you place the food in the oven.
- ⁴ Roast with the lid on first. Remove the lid after roasting for 50 minutes and add approx. 0.5 litres of liquid.
- ⁵ If you have a separate food probe you can use the core temperature shown.

Cooking charts

Poultry, fish

Food (accessories)		 [°C]	 ³ ₁	 [min.]	 ⁶ [°C]
Poultry, 0.8–1.5 kg (universal tray)		170–180	1	50–60	85–90
Chicken, approx. 1.2 kg (rack on top of universal tray)		180–190 ¹	1	55–65 ³	85–90
Poultry, approx. 2 kg (oven dish)		170–180	1	100–120 ⁴	85–90
		190–200	1	110–130 ⁴	85–90
Poultry, approx. 4 kg (oven dish)		160–170	1	180–200 ⁵	90–95
		180–190	1	180–200 ⁵	90–95
Fish, 200–300 g (e.g. trout) (universal tray)		210–220 ²	1	15–25	75–80
Fish, 1–1.5 kg (e.g. salmon trout) (universal tray)		210–220 ²	1	30–40	75–80
Fish fillet in foil, 200–300 g (universal tray)		200–210	1	25–30	75–80

 Function,  Temperature, ³₁ Shelf level  Cooking duration, ⁶ Core temperature,  Fan Plus,  Fan Grill,  Conventional Heat,  Eco Fan Heat

¹ Pre-heat the oven for 5 minutes before placing the food inside. Do not use the Booster  function for this purpose.

² Pre-heat the oven before placing the food inside. Do not use the Booster  function for this purpose.

³ If possible, turn the food halfway through the cooking duration.

⁴ Add approx. 0.25 litres of liquid at the start.

⁵ Add approx. 0.5 litres of liquid after 30 minutes.

⁶ If you have a separate food probe you can use the core temperature shown.

Miele Australia Pty. Ltd.

ACN 005 635 398

ABN 96 005 635 398

Level 4, 141 Camberwell Road
Hawthorn East, VIC 3123

1300 464 353 (1300 4 MIELE)

info@miele.com.au

www.miele.com.au

Miele New Zealand Limited

IRD 98 463 631

8 College Hill
Freemans Bay, Auckland 1011

0800 464 353 (0800 4 MIELE)

customercare@miele.co.nz

www.miele.co.nz

Miele Global Headquarters

Germany

Miele & Cie. KG

Carl-Miele-Straße 29

33332 Gütersloh

Federal Republic of Germany

H 2890 B

en-AU, NZ

M.-Nr. 11 190 340 / 11